



US00D812479S

(12) **United States Design Patent** (10) **Patent No.:** **US D812,479 S**
Li (45) **Date of Patent:** **** Mar. 13, 2018**

(54) **PRODUCT CONTAINER**

(71) Applicant: **WM. WRIGLEY JR. COMPANY,**
Chicago, IL (US)

(72) Inventor: **Monica Li,** Guangzhou (CN)

(73) Assignee: **WM. WRIGLEY JR. COMPANY,**
Chicago, IL (US)

(**) Term: **15 Years**

(21) Appl. No.: **29/563,608**

(22) Filed: **May 6, 2016**

(30) **Foreign Application Priority Data**

Nov. 13, 2015 (CN) 2015 3 0452840

(51) **LOC (11) Cl.** **09-01**

(52) **U.S. Cl.**
USPC **D9/503; D9/549; D9/454**

(58) **Field of Classification Search**

USPC D9/500-504, 505, 516, 519-521, 529,
D9/549, 558, 682, 686, 688-691, 551,
D9/553, 556, 452-454, 772, 439, 642,
D9/424, 425, 428, 249, 539, 716, 763,
D9/776-779; D7/602, 537, 612, 615,
D7/629, 619, 601, 608, 624.3; 215/379,
215/381-382; 220/660, 669-673, 675;
206/426; D11/152; D32/53, 53.1

(Continued)

(56) **References Cited**

U.S. PATENT DOCUMENTS

1,197,389 A * 9/1916 Newton B65D 1/0223
215/383

D354,200 S * 1/1995 Grappolini D7/511

(Continued)

Primary Examiner — Anhdao Doan

Assistant Examiner — Mary Malley

(57) **CLAIM**

I claim the ornamental design for a product container, as substantially shown and described.

DESCRIPTION

FIG. 1 is a front view of the product container shown in an attached configuration.

FIG. 2 is a back view thereof.

FIG. 3 is a left side view thereof.

FIG. 4 is a right side view thereof.

FIG. 5 is a top plan view thereof.

FIG. 6 is a bottom plan view thereof.

FIG. 7 is a perspective view thereof.

FIG. 8 is a front view of the container shown without the lid to show the inner structure of the product container that is not visible when the lid is shown in the attached configuration.

FIG. 9 is a back view thereof.

FIG. 10 is a left side view thereof.

FIG. 11 is a right side view thereof.

FIG. 12 is a top plan view thereof.

FIG. 13 is a bottom plan view thereof.

FIG. 14 is a perspective view thereof.

FIG. 15 is a front view of the lid shown without the container to show the inner structure of the lid that is not visible when the lid is shown in the attached configuration.

FIG. 16 is a back view thereof.

FIG. 17 is a left side view thereof.

FIG. 18 is a right side view thereof.

FIG. 19 is a top plan view thereof.

FIG. 20 is a bottom plan view thereof; and,

FIG. 21 is a perspective view thereof.

The broken lines show portions of the product container and surface details that form no part of the claimed design.

1 Claim, 10 Drawing Sheets

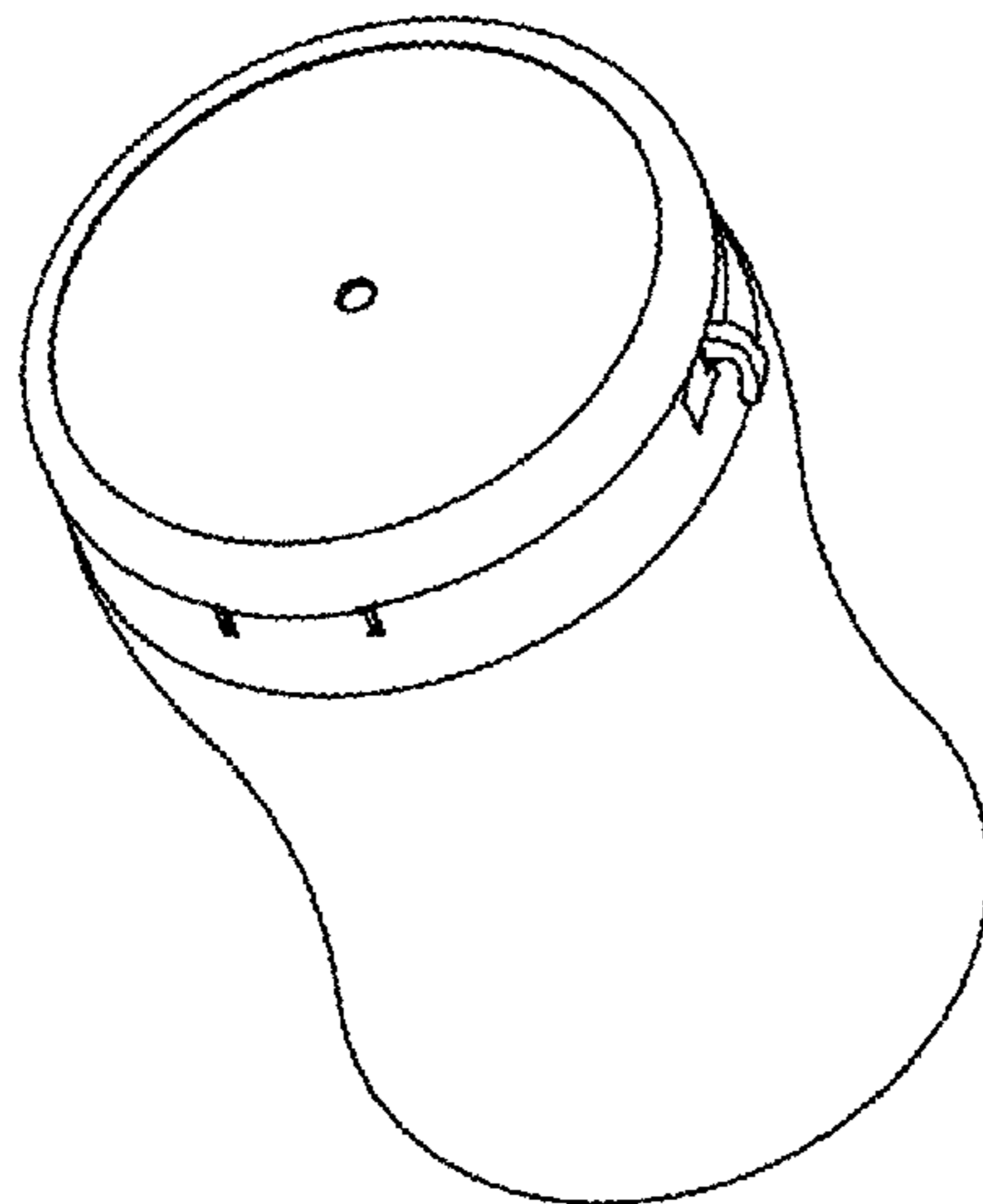

(58) **Field of Classification Search**

CPC ... B65D 1/00; B65D 1/02; B65D 1/07; B65D
1/0023; B65D 1/10; B65D 23/00; B65D
2501/00; B65D 2501/0009; B65D 33/00;
B65D 75/5872; B65D 85/505; B65D
1/0223; B65D 1/243; B65D 81/00; F21V
35/00; F21L 25/00; A47G 19/2205; A47G
2400/045; A47G 7/07; A61L 9/12

See application file for complete search history.

(56) **References Cited**

U.S. PATENT DOCUMENTS

| | | | | | | |
|----------|---|---|---------|-------------|-------|--------|
| D445,337 | S | * | 7/2001 | Croft | | D9/450 |
| D553,446 | S | * | 10/2007 | Yang | | D7/615 |
| D568,155 | S | * | 5/2008 | Glydon | | D9/500 |
| D590,667 | S | * | 4/2009 | Trombly | | D7/615 |
| D623,060 | S | * | 9/2010 | Hassamanci | | D9/438 |
| D640,556 | S | * | 6/2011 | Bragg | | D9/449 |
| D668,509 | S | * | 10/2012 | Beugelsdijk | | D7/400 |
| D693,650 | S | * | 11/2013 | De Leo | | D7/629 |
| D745,400 | S | * | 12/2015 | Canuto | | D9/503 |
| D768,494 | S | * | 10/2016 | Li | | D9/504 |
| D773,301 | S | * | 12/2016 | Li | | D9/500 |

* cited by examiner

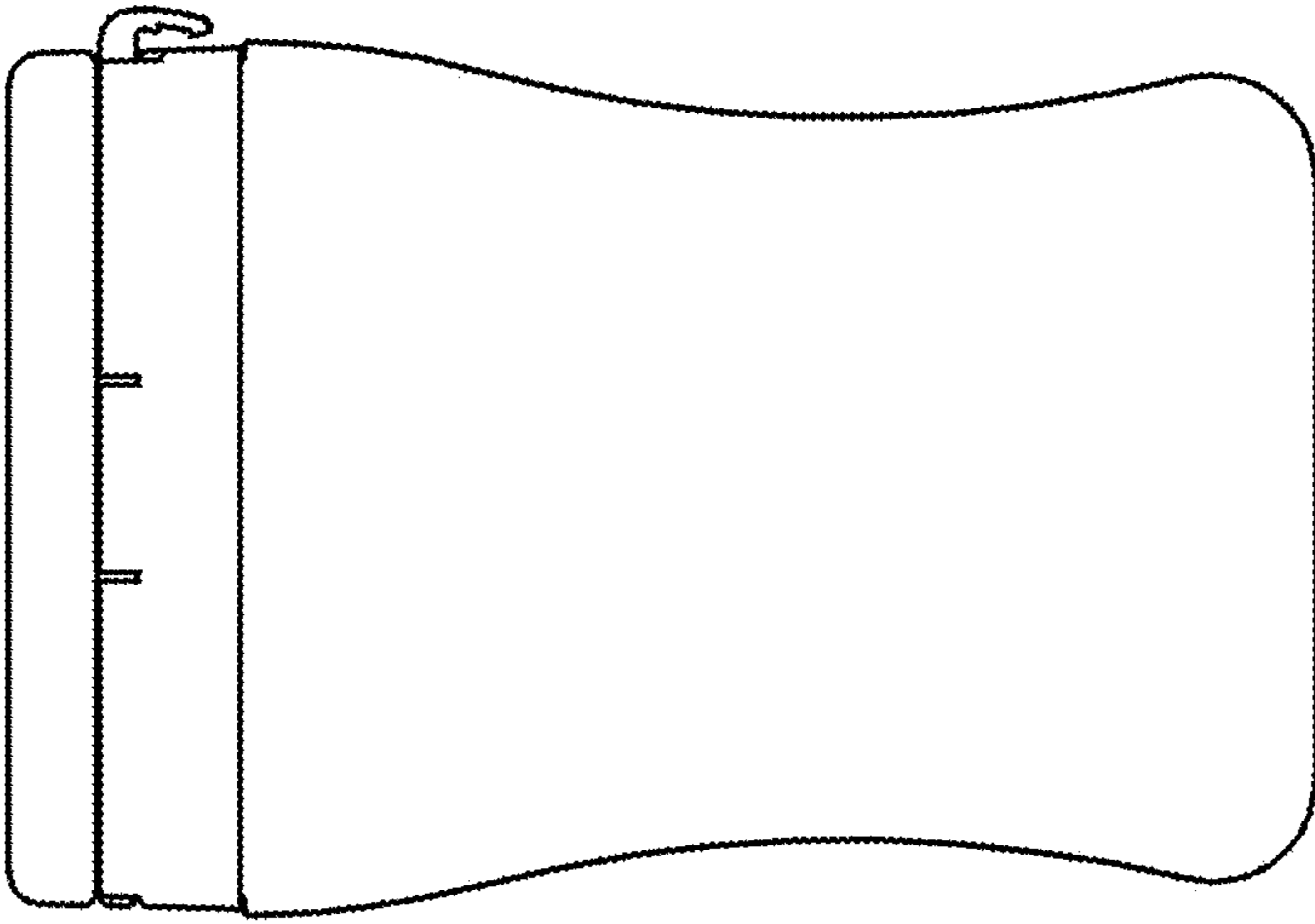

FIG. 2

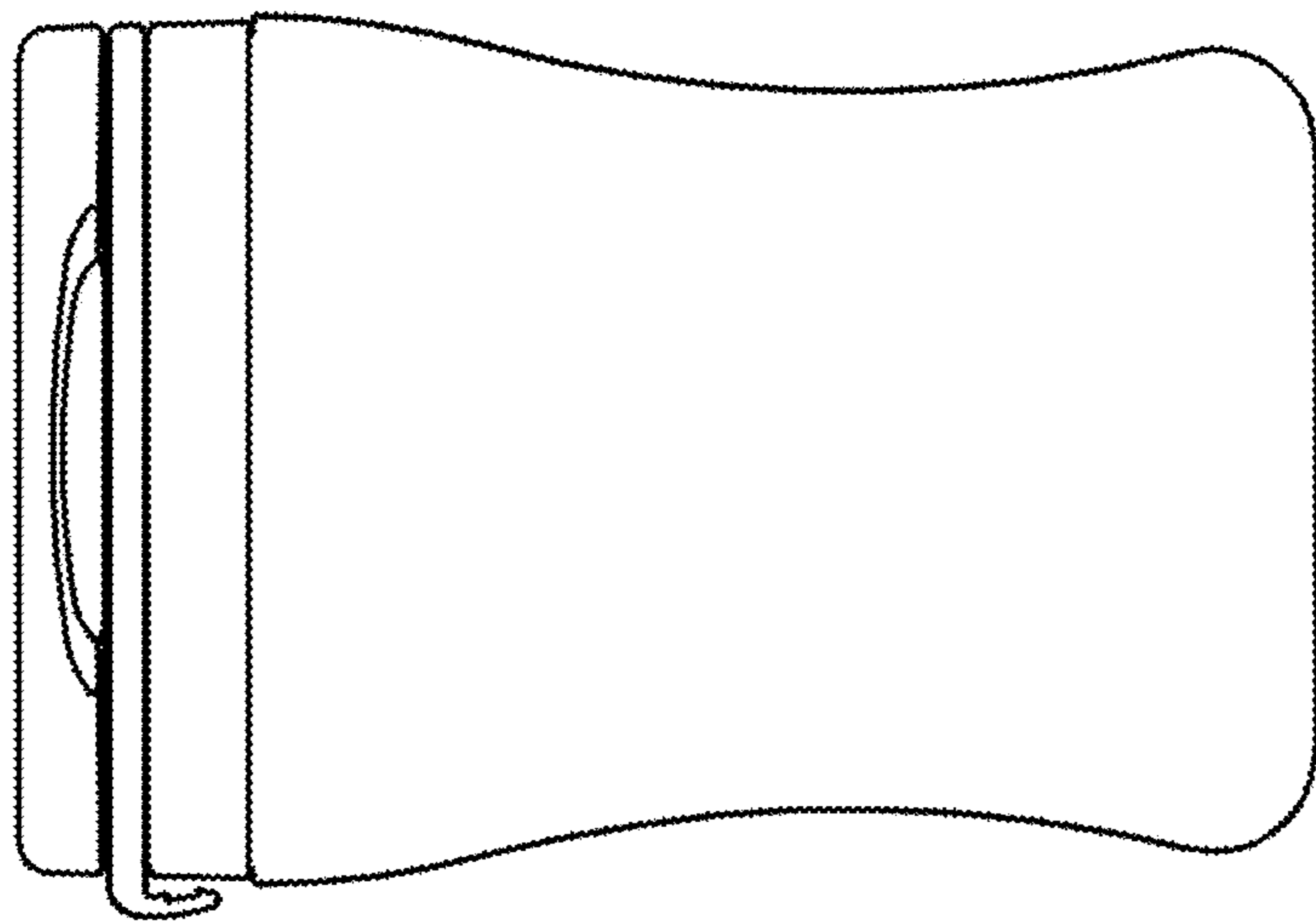

FIG. 1

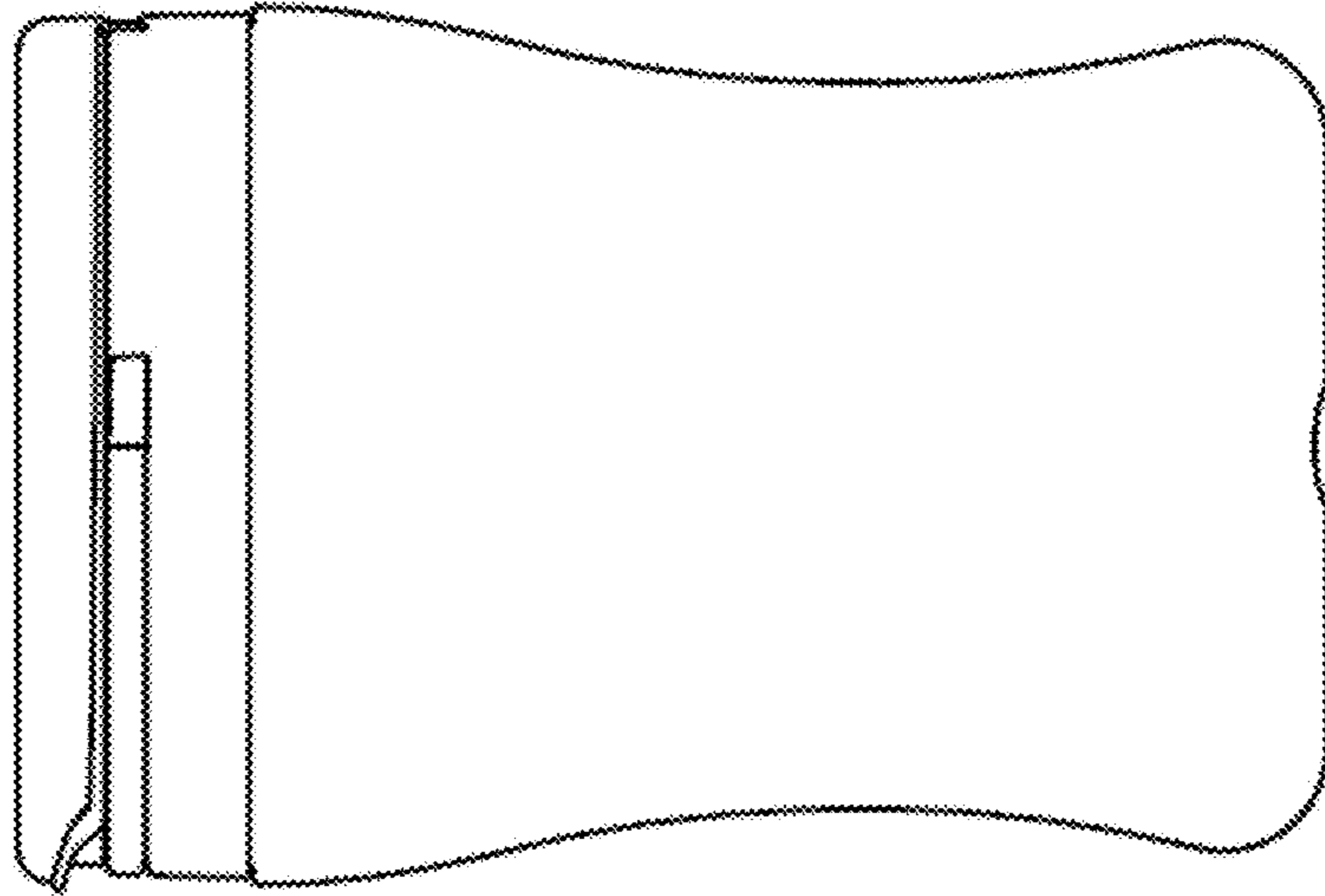

FIG. 4

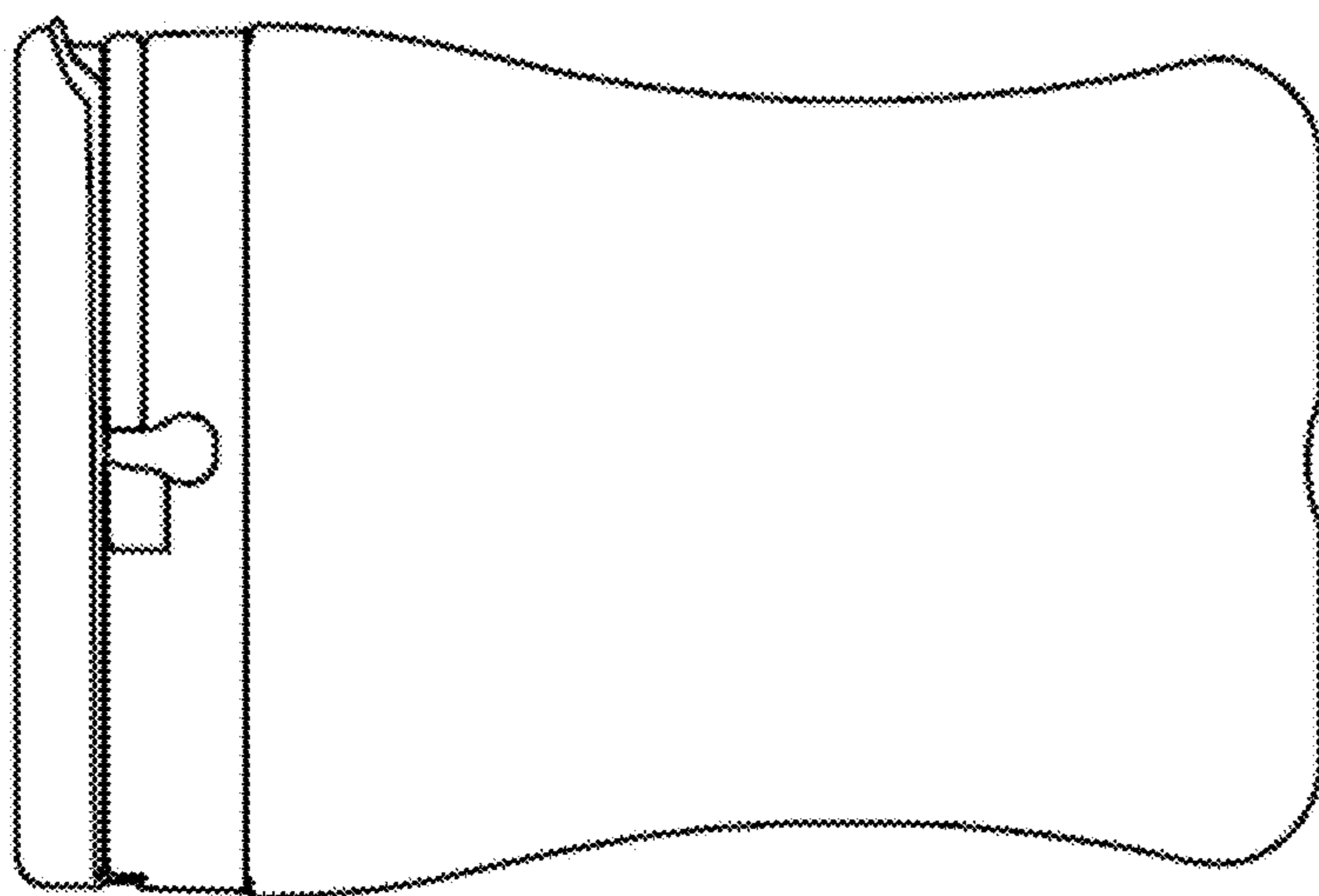

FIG. 3

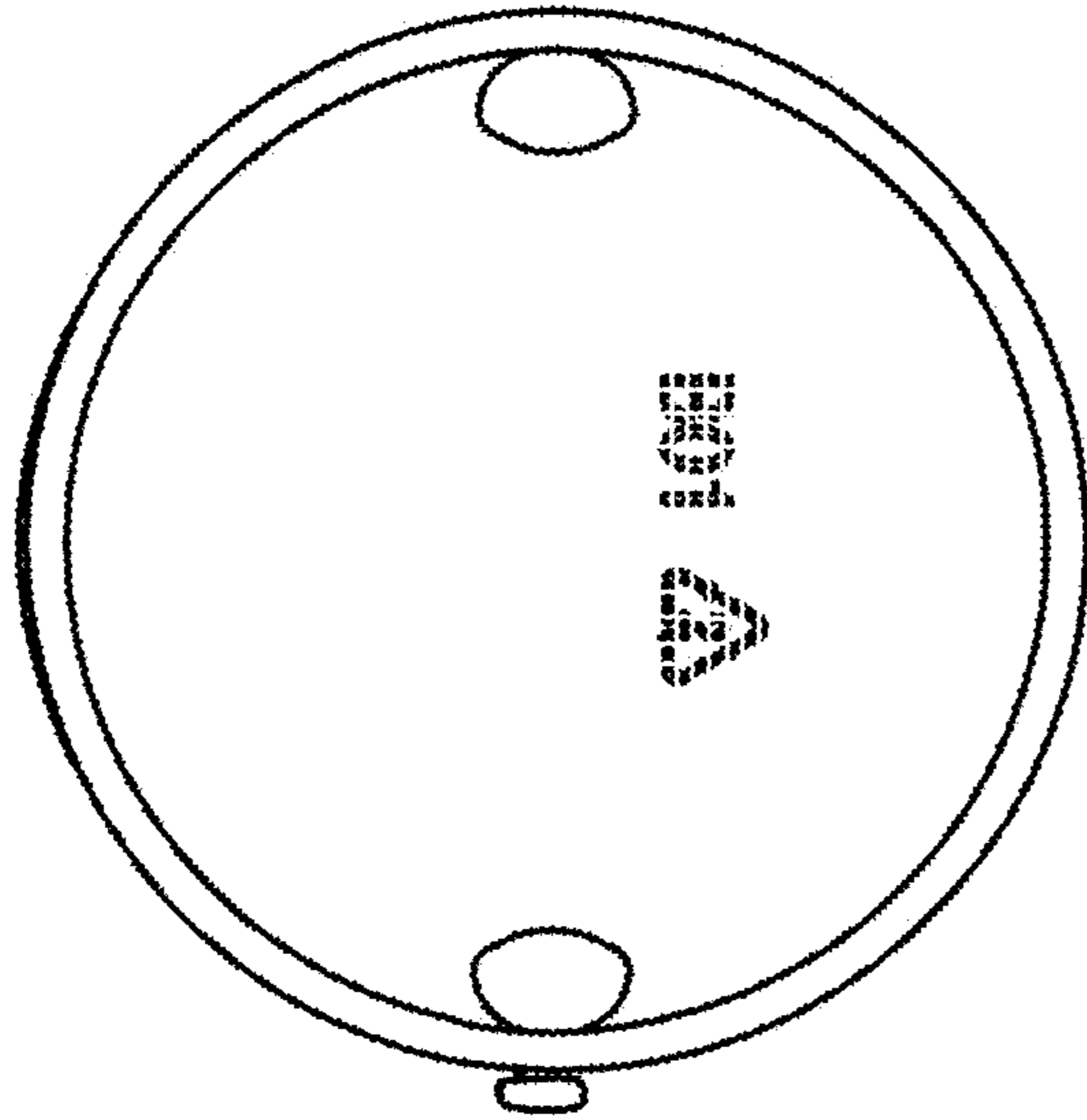

FIG. 6

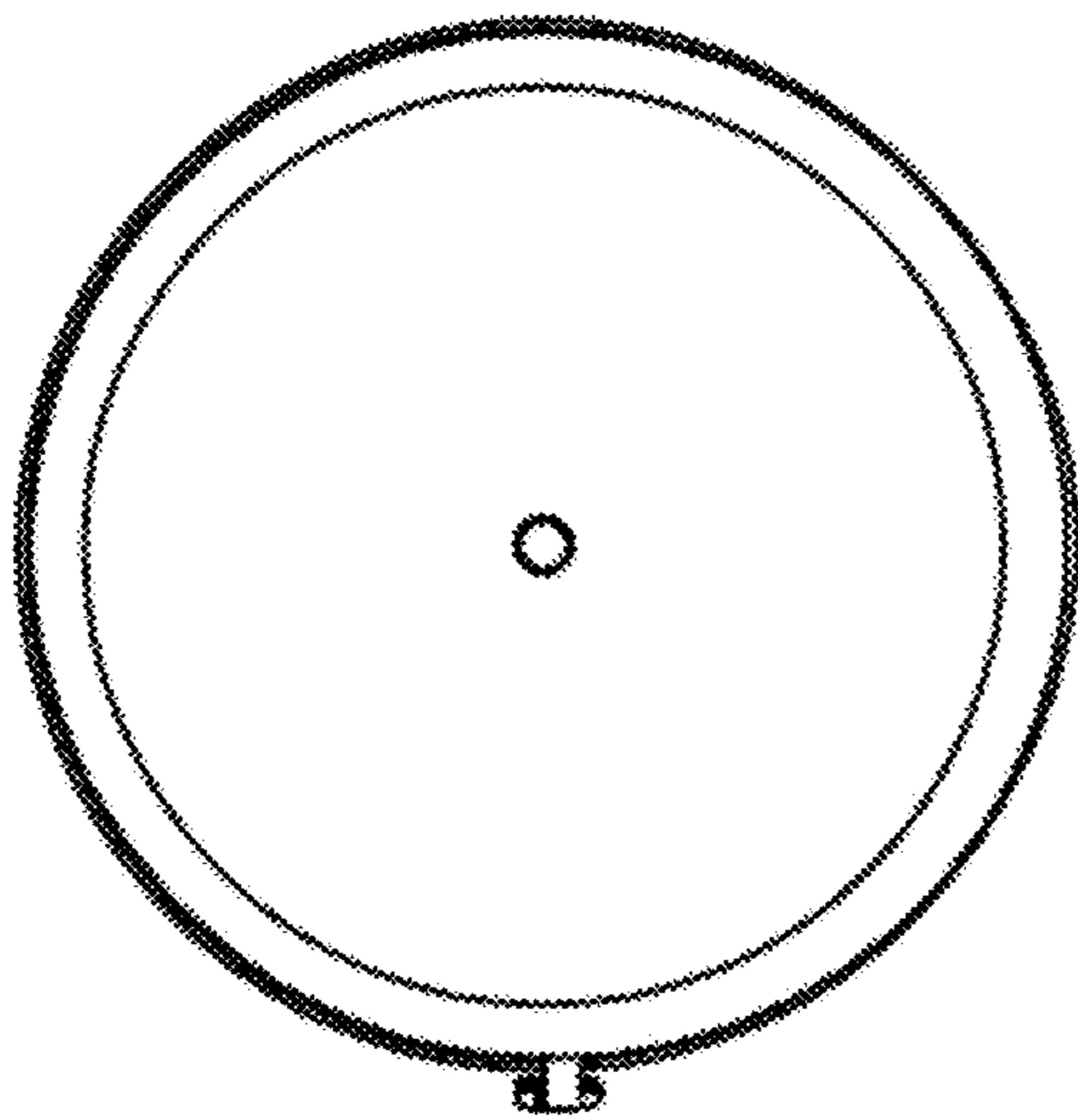

FIG. 5

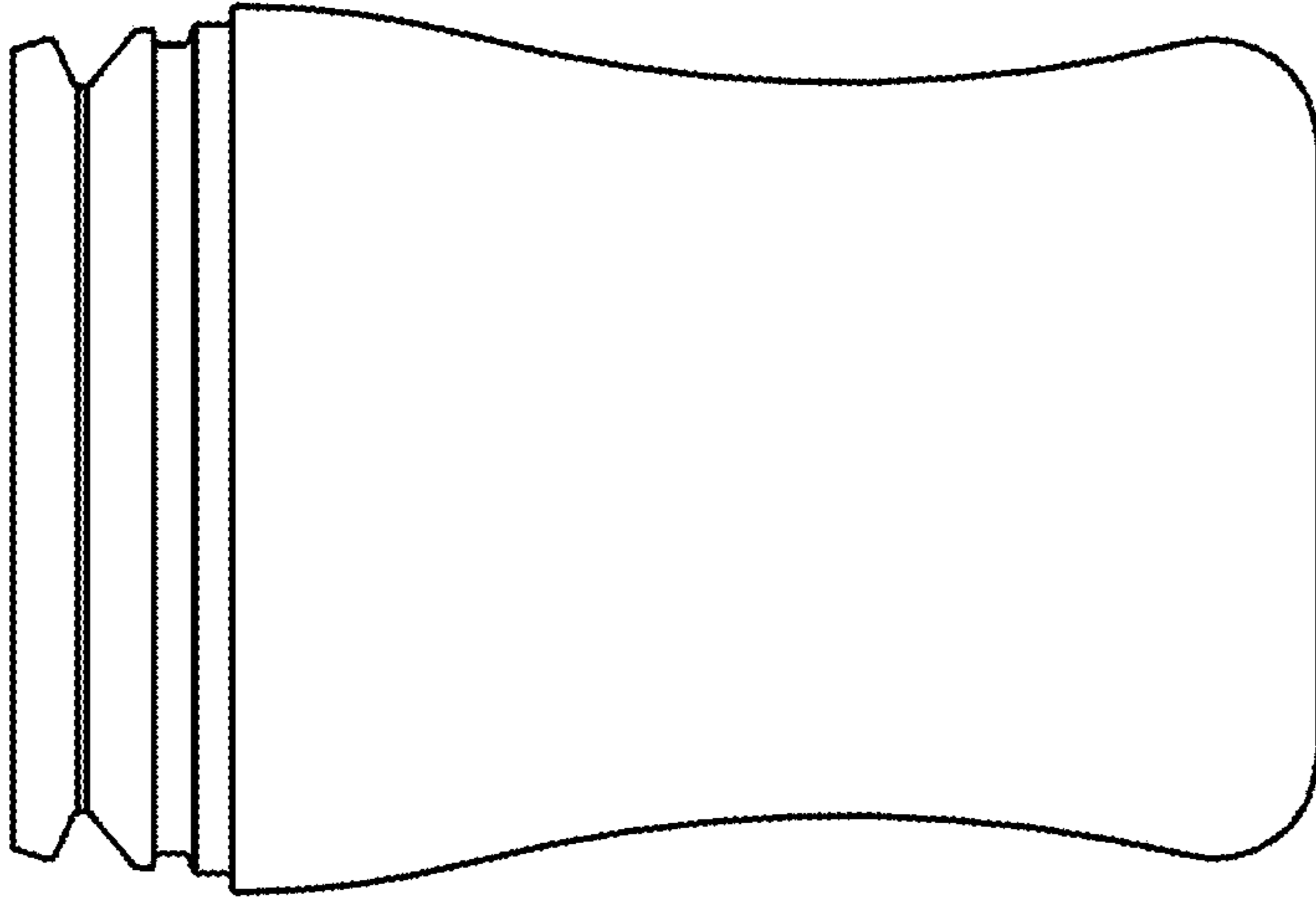

FIG. 8

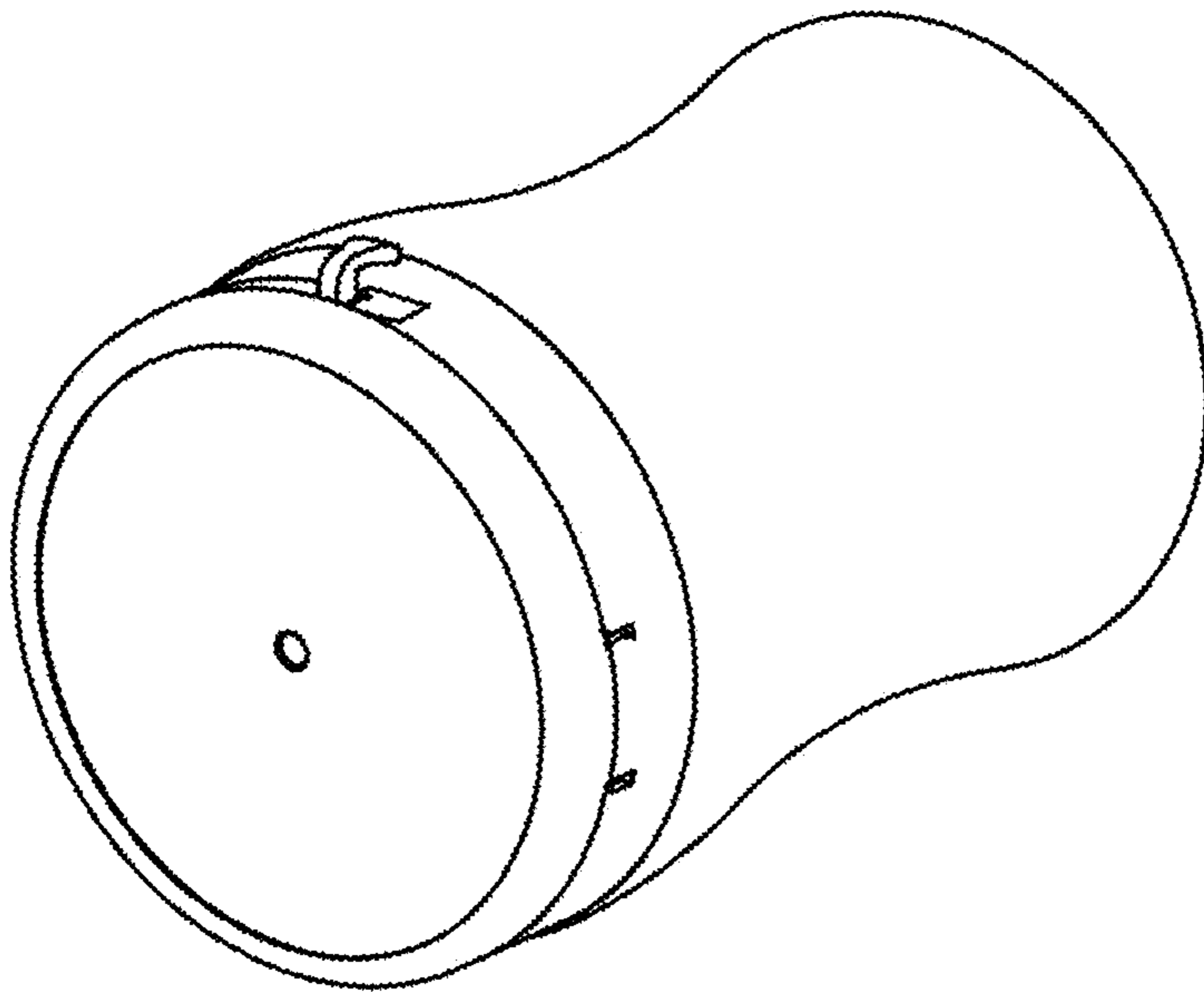

FIG. 7

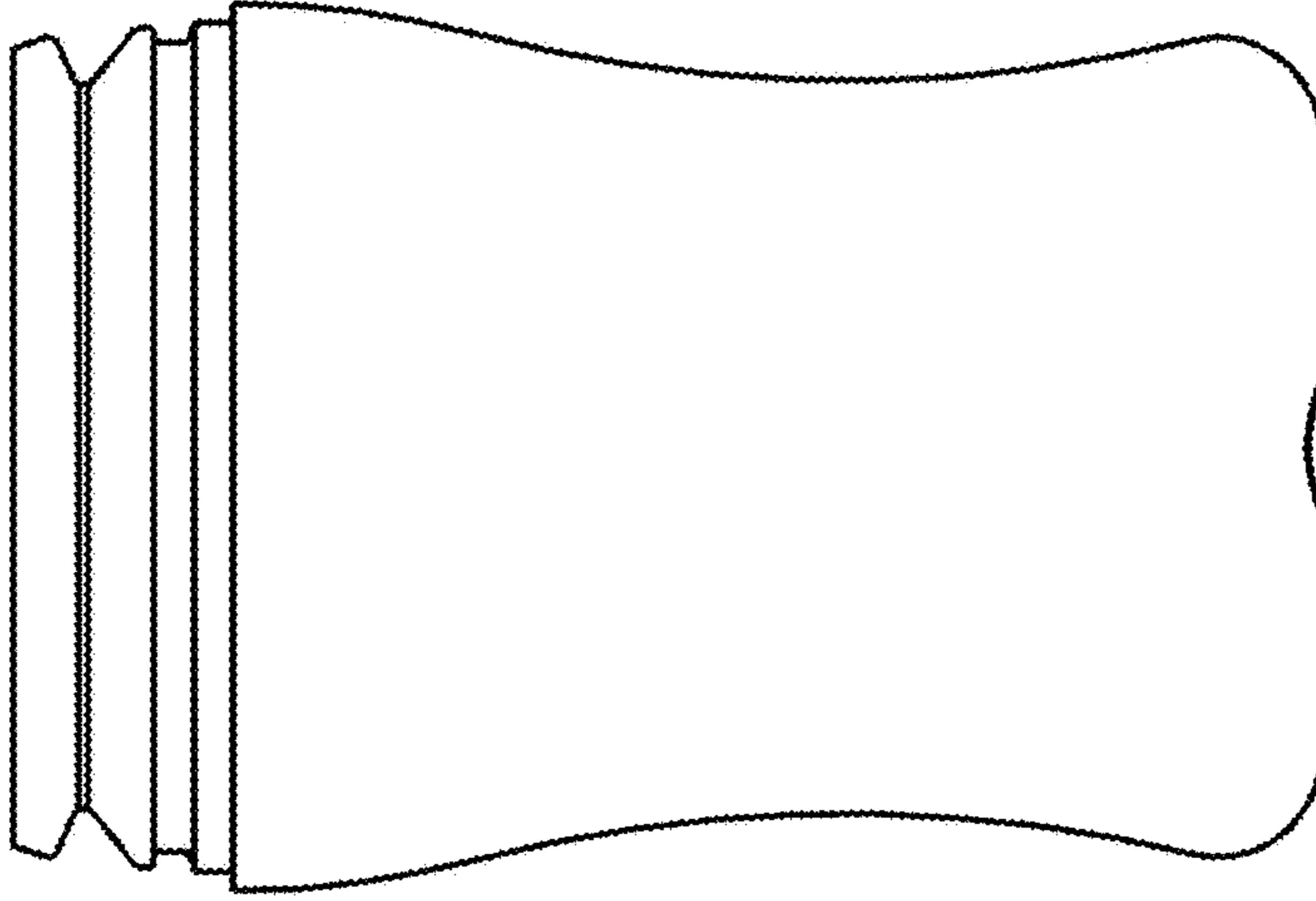

FIG. 9

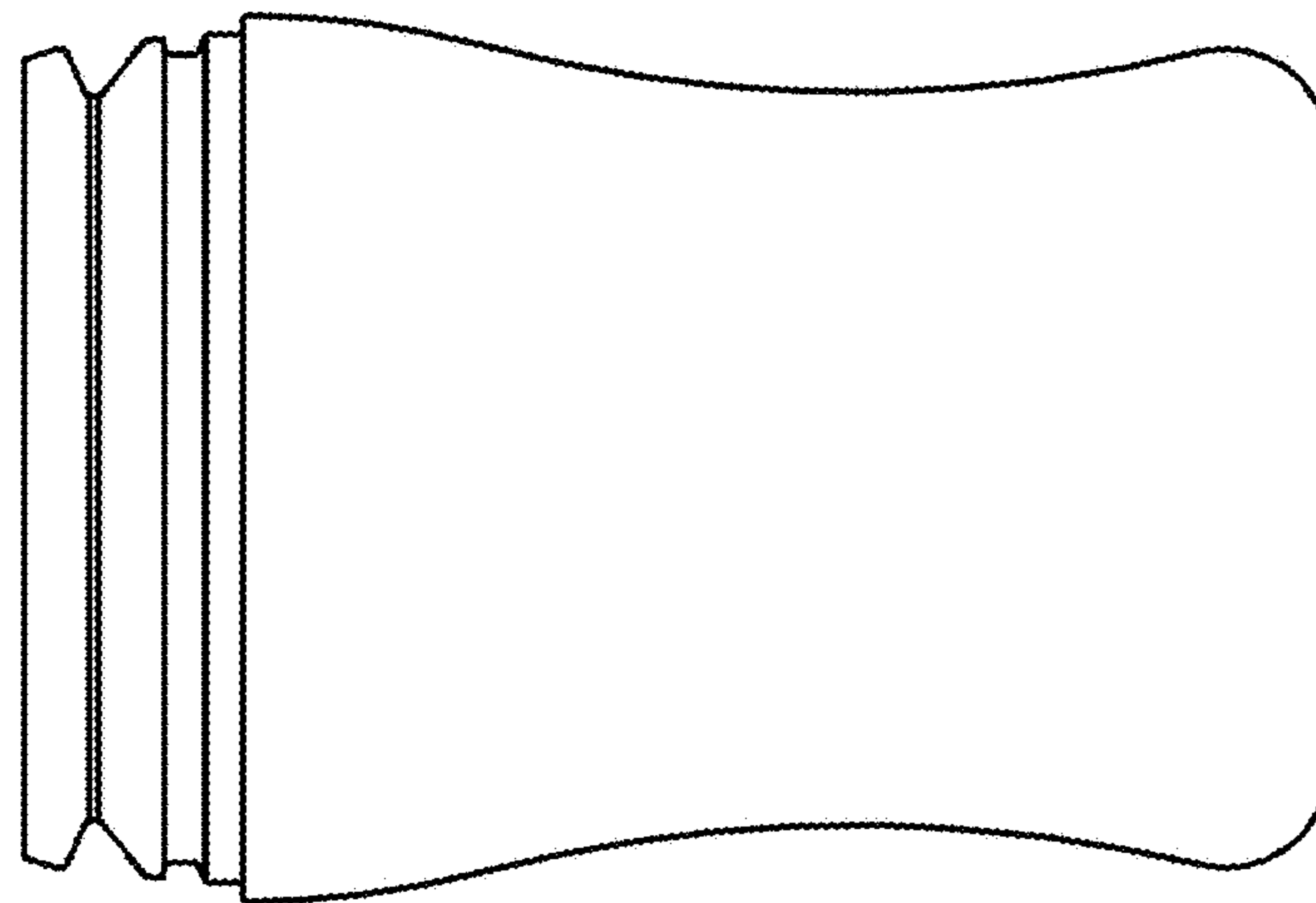

FIG. 10

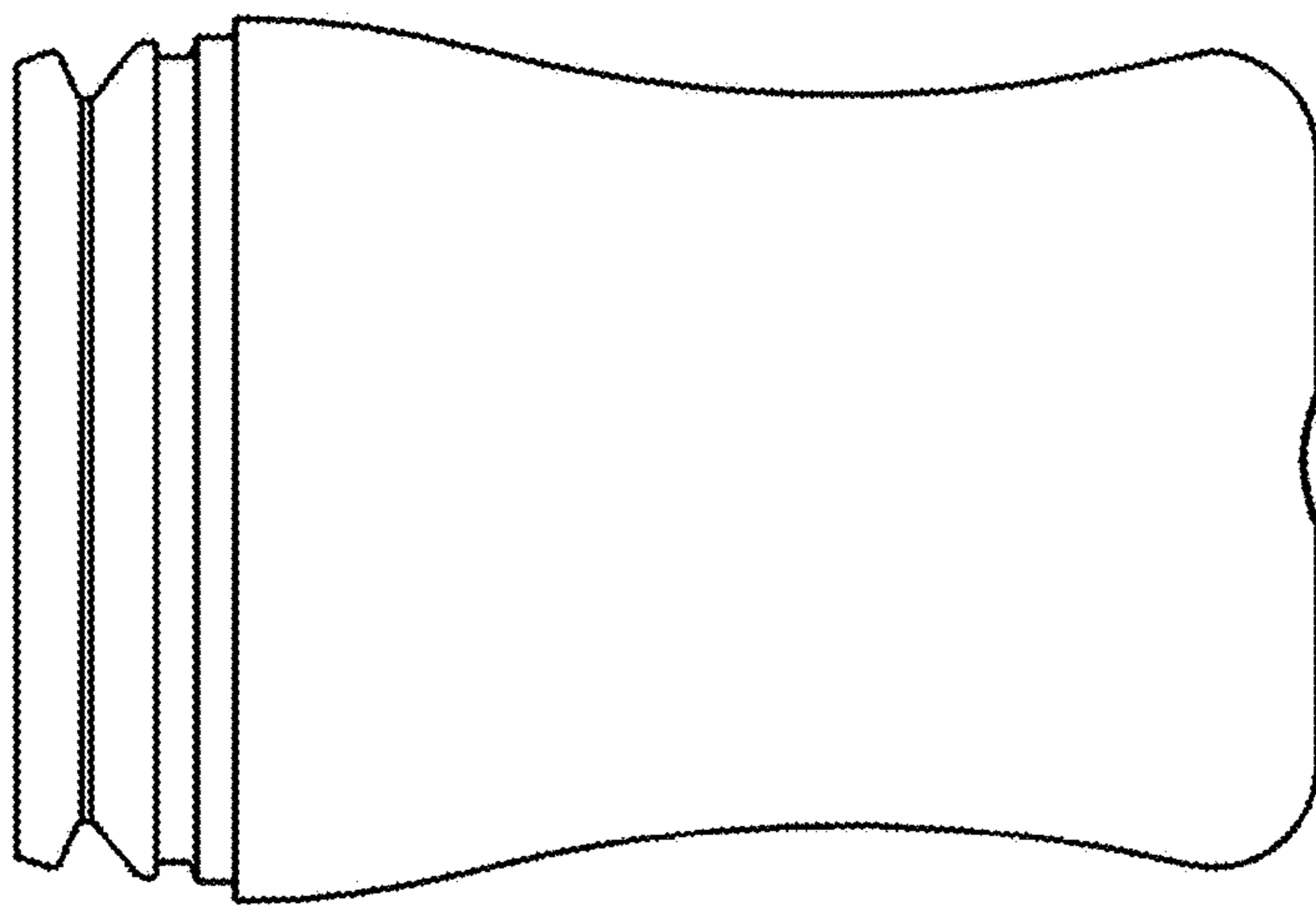

FIG. 11

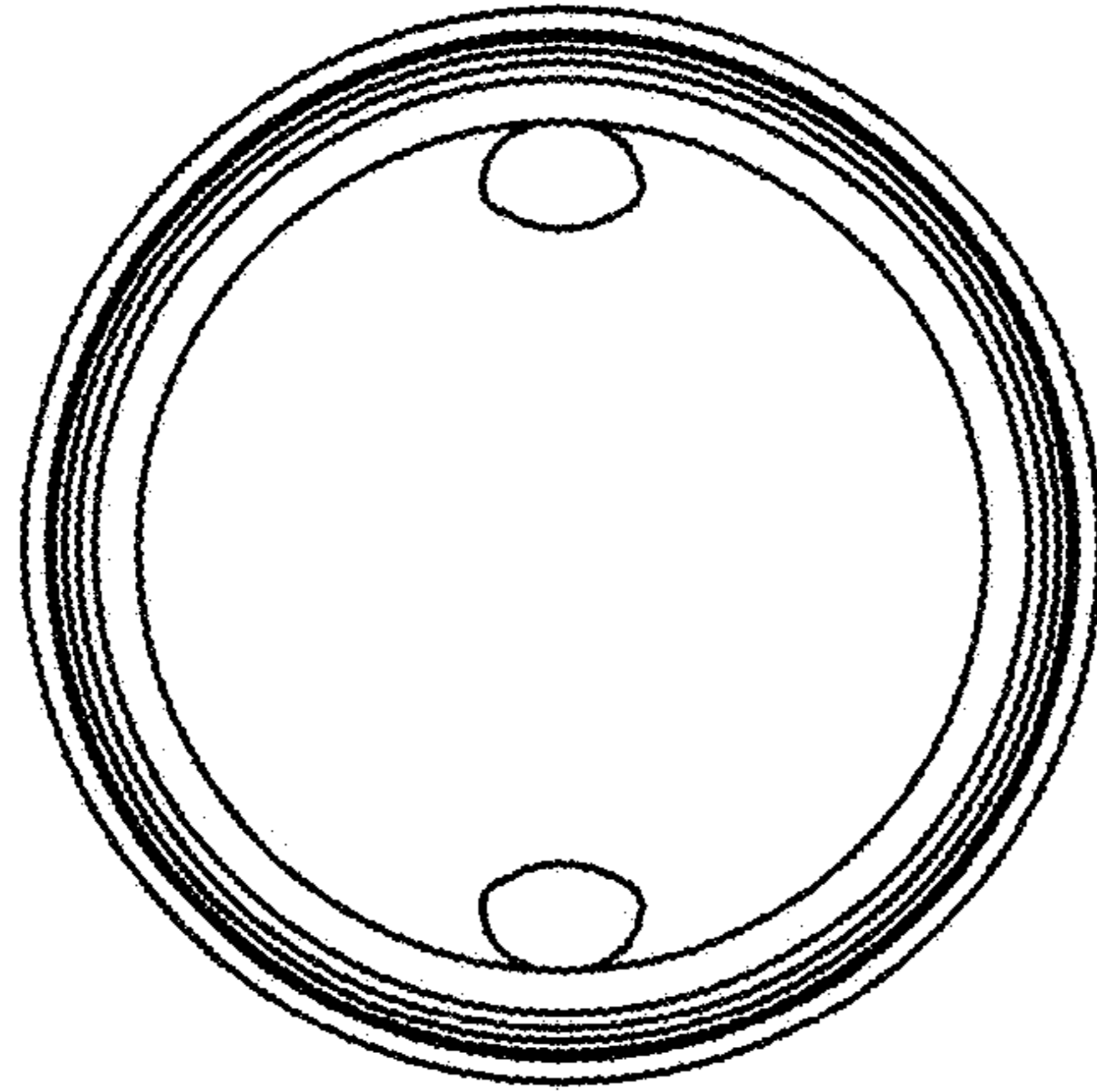

FIG. 12

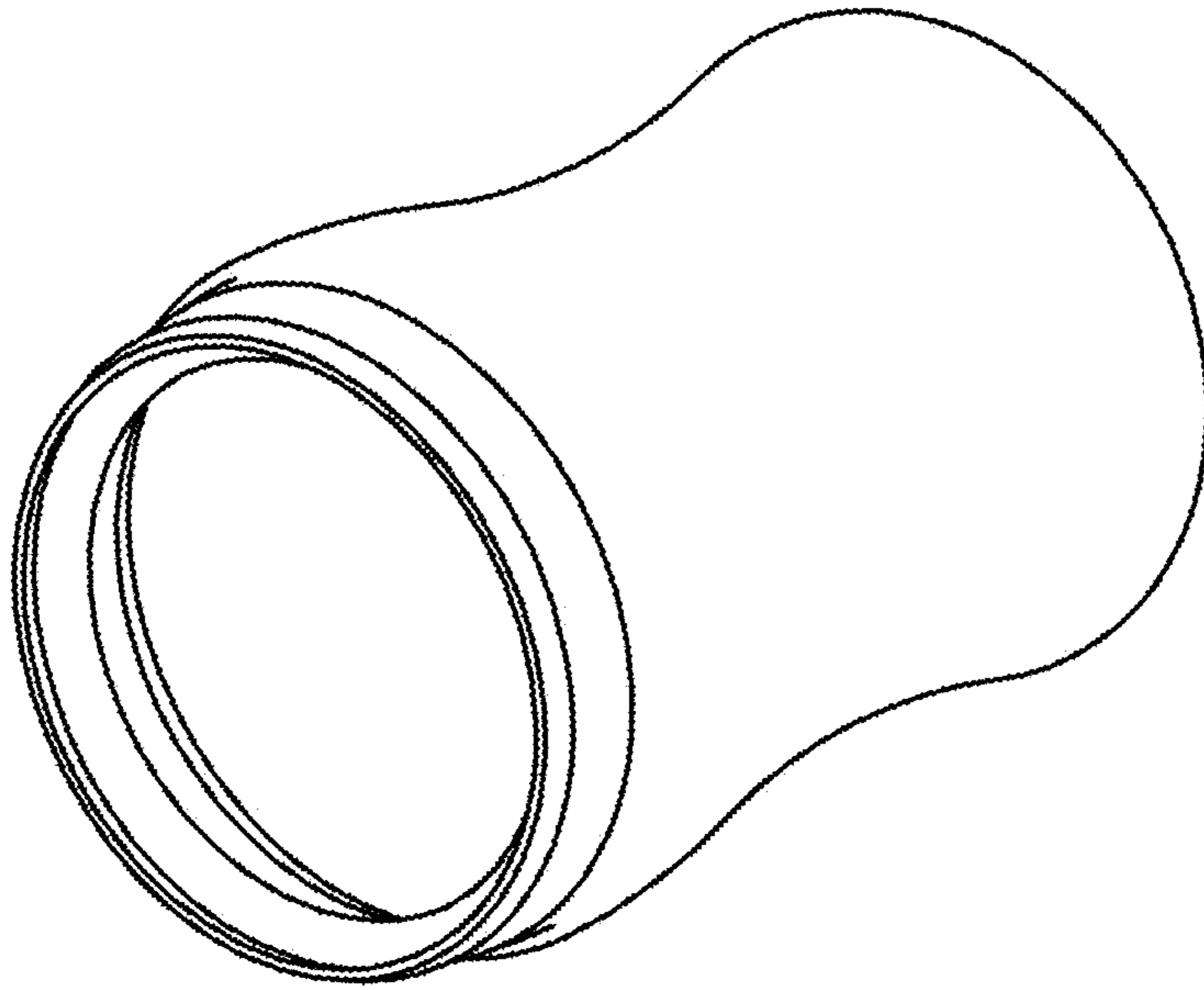

FIG. 14

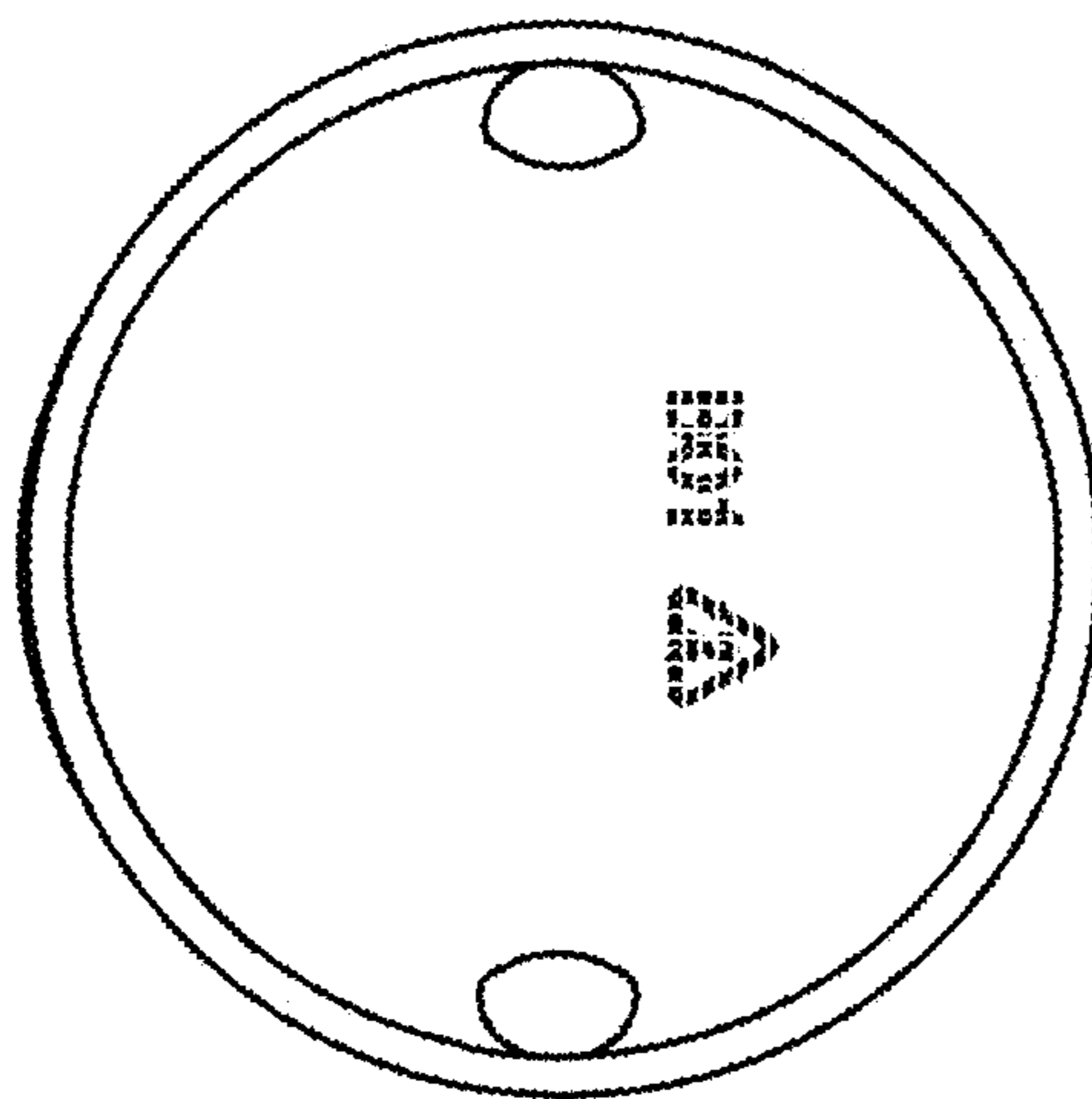

FIG. 13

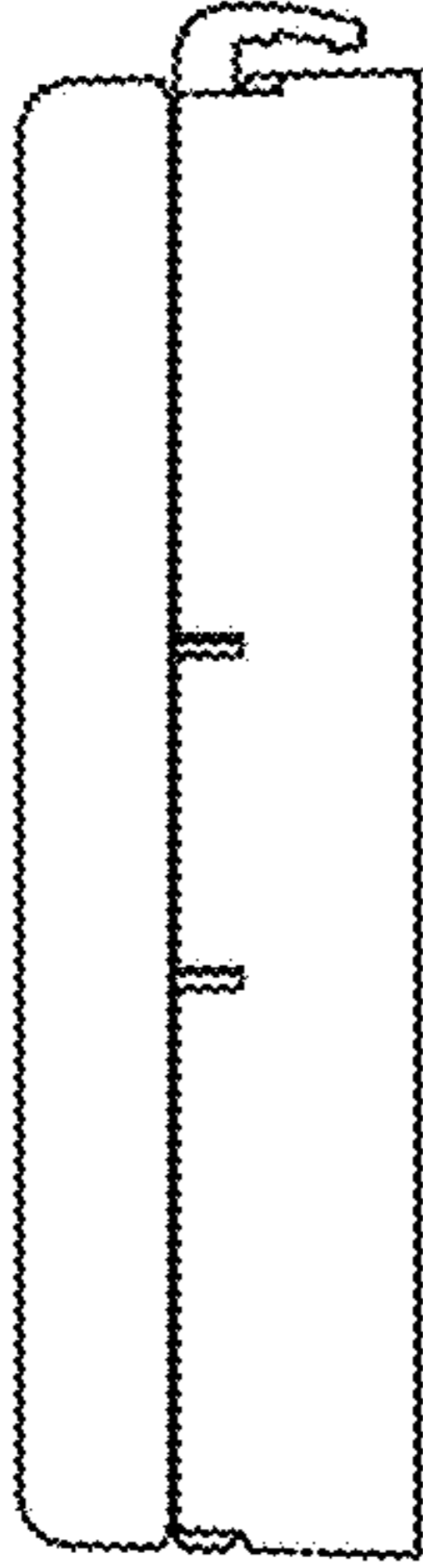

FIG. 15

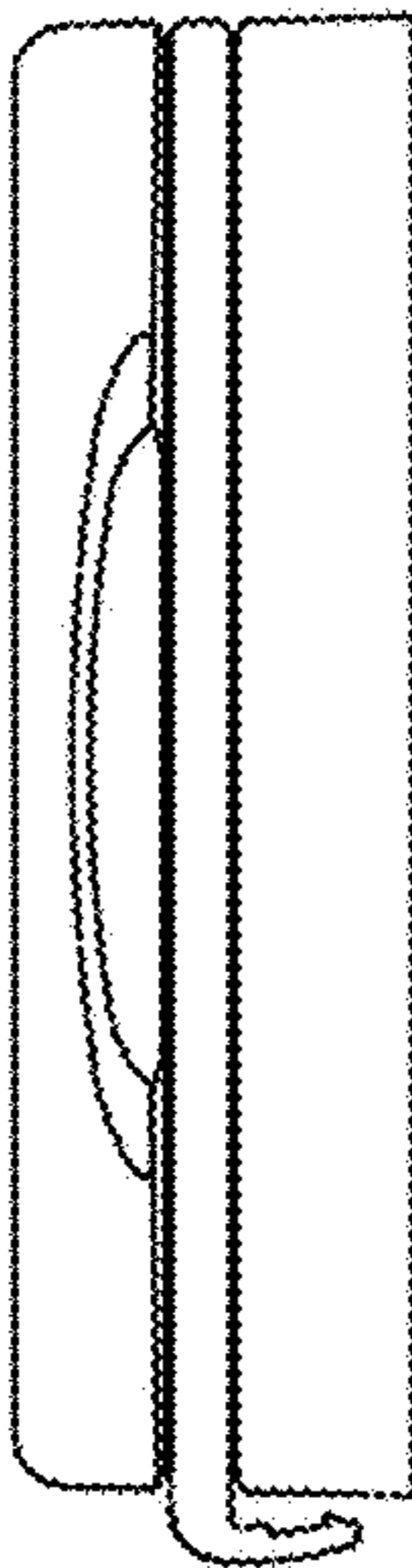

FIG. 16

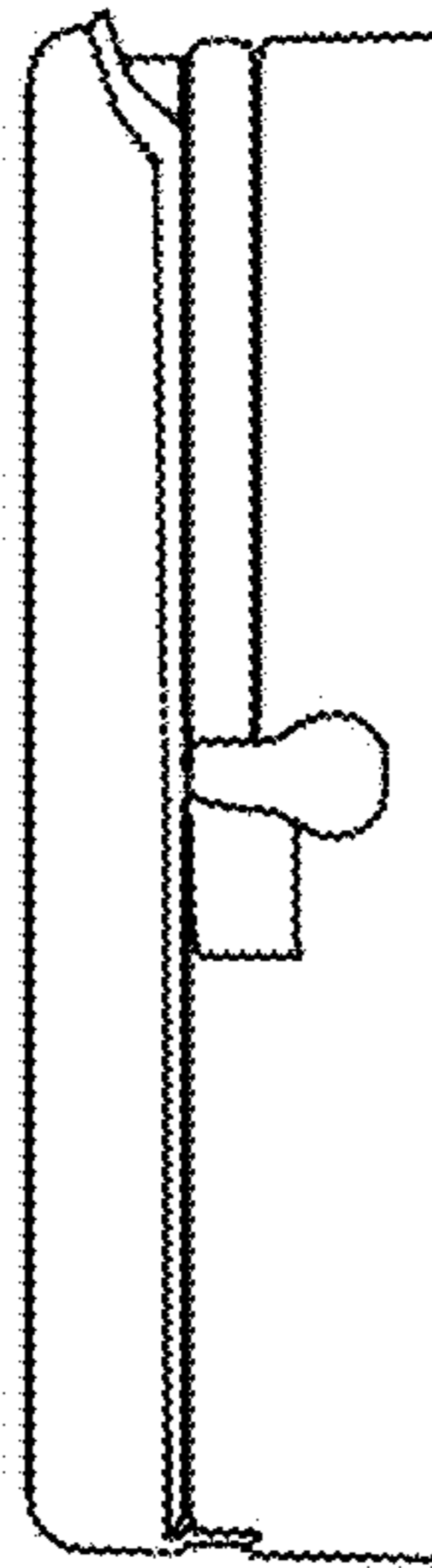

FIG. 17

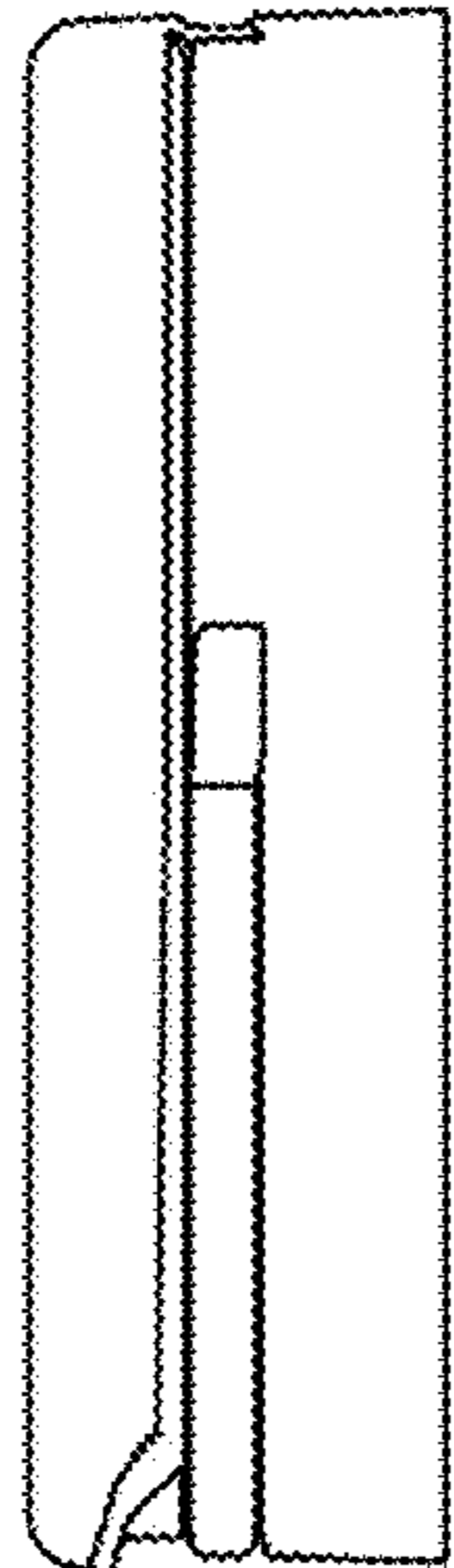

FIG. 18

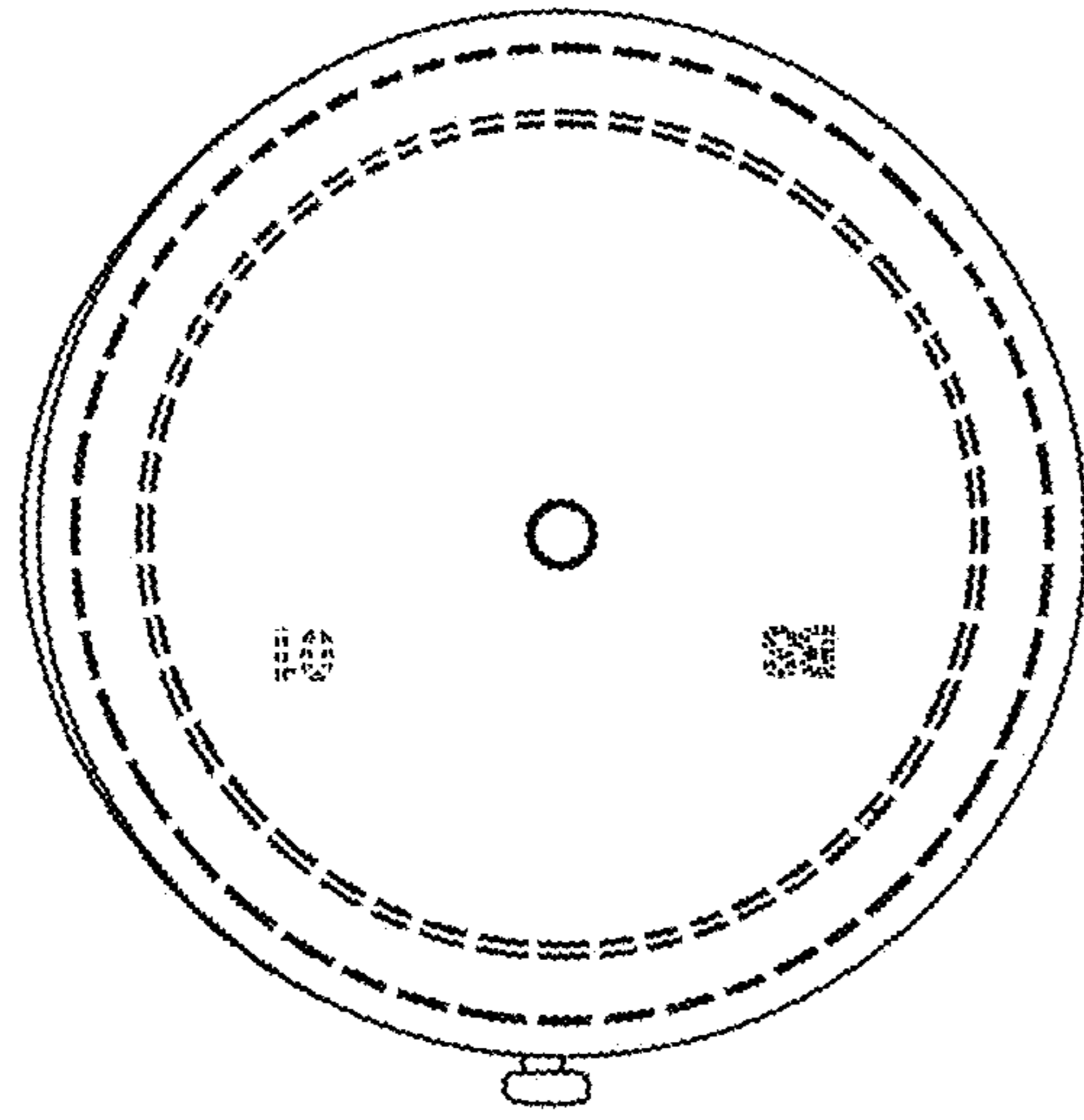

FIG. 20

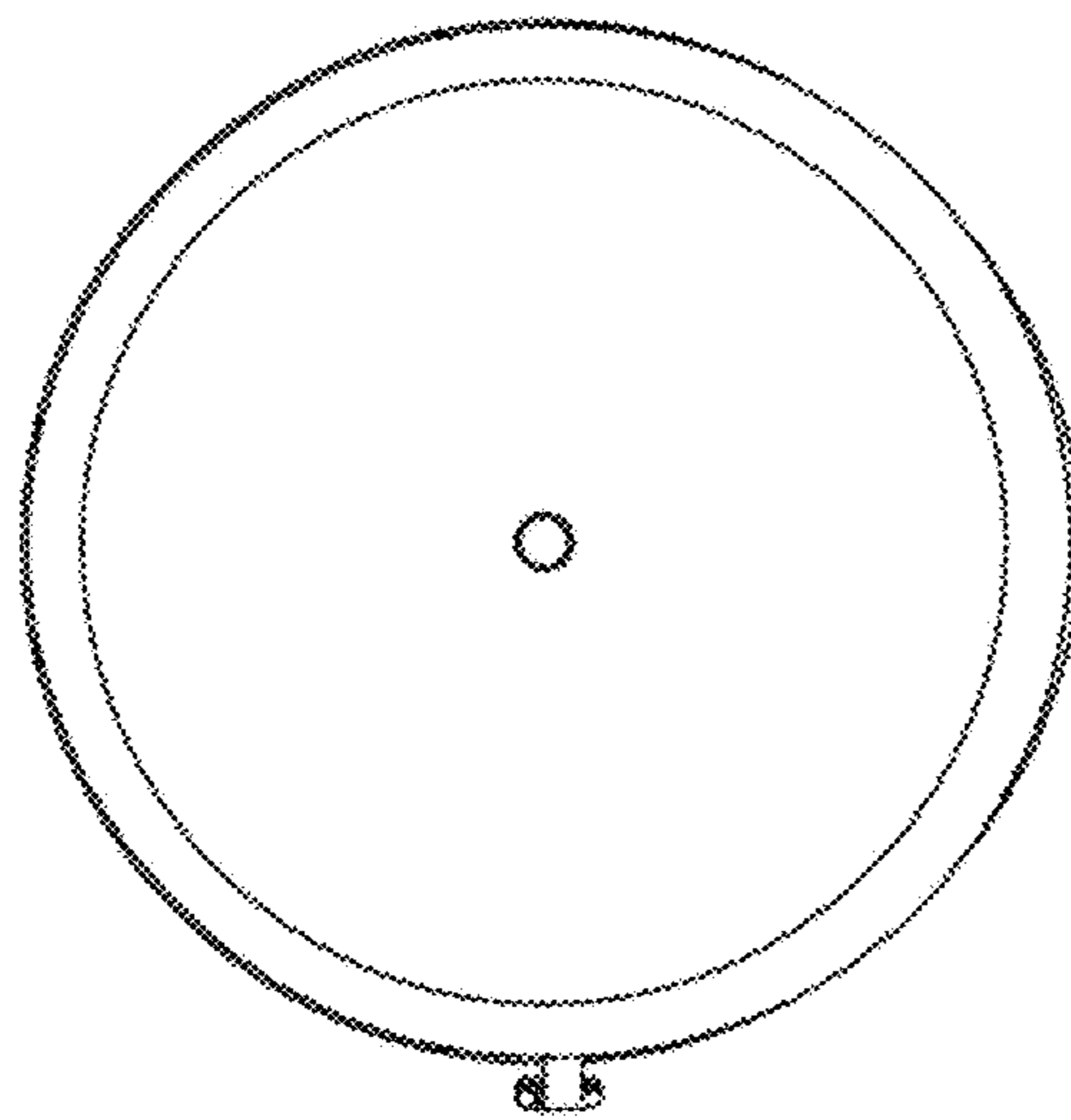

FIG. 19

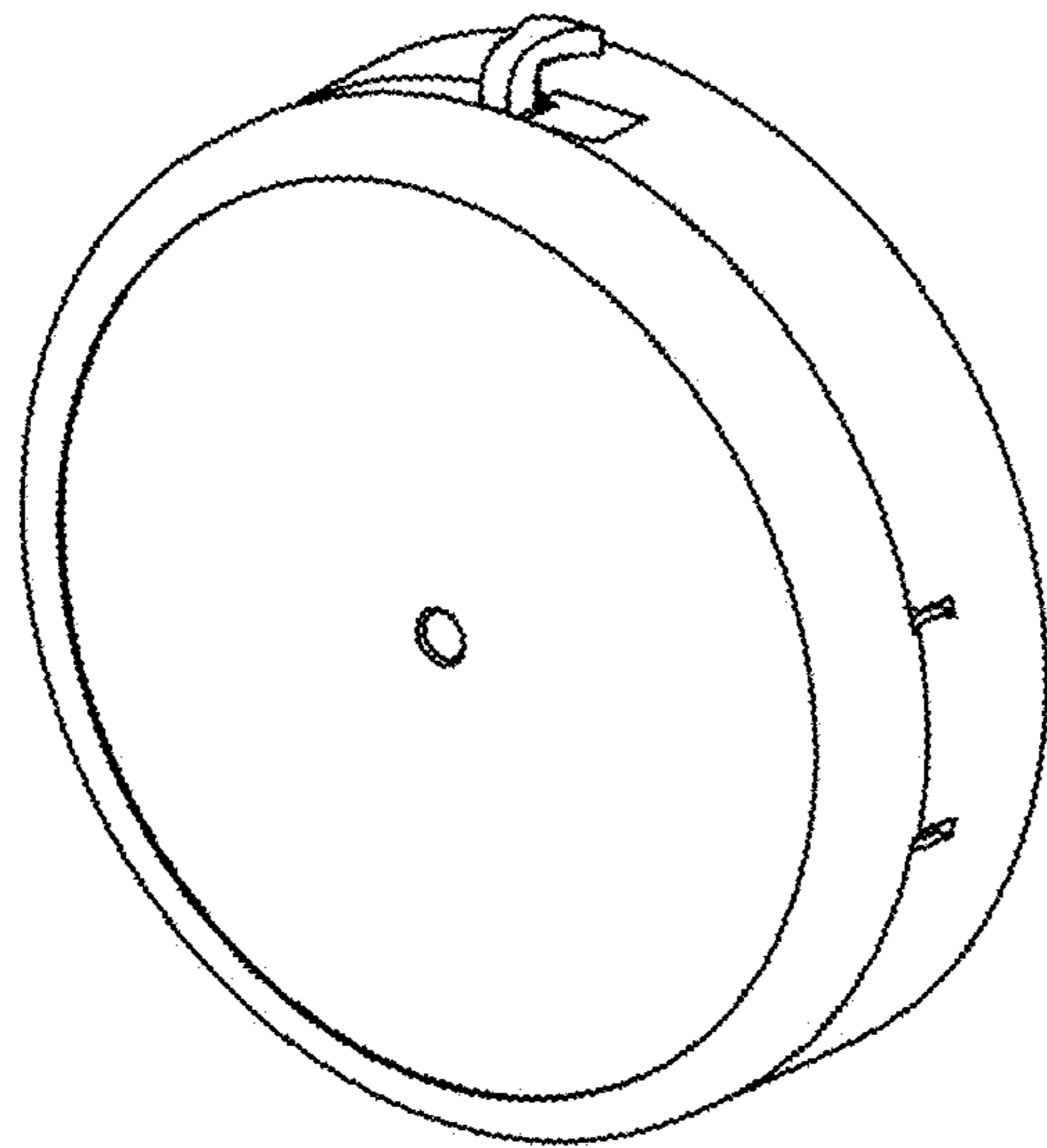

FIG. 21