



US00D812443S

(12) **United States Design Patent** (10) **Patent No.:** **US D812,443 S**  
**Gonzalez et al.** (45) **Date of Patent:** **\*\* Mar. 13, 2018**

(54) **CUTTING ELEMENT**

(71) Applicant: **Deere & Company**, Moline, IL (US)  
(72) Inventors: **Ivan Alejandro Gonzalez**, Monterrey (MX); **Bernardo Harvey**, Monterrey (MX); **Cesar Garcia**, Monterrey (MX)  
(73) Assignee: **Deere & Company**, Moline, IL (US)  
(\*\*) Term: **15 Years**

(21) Appl. No.: **29/576,691**  
(22) Filed: **Sep. 6, 2016**  
(51) **LOC (11) Cl.** ..... **08-03**  
(52) **U.S. Cl.**  
USPC ..... **D8/20; D15/17**  
(58) **Field of Classification Search**  
USPC ..... D8/5, 8, 12, 14, 19, 20, 46, 47, 70, 71, D8/86, 98; D15/17, 29, 122, 130, 131, D15/127; D7/693; 56/12.7, 295  
CPC ..... A01D 34/01; A01D 34/02; A01D 34/04; A01D 34/06; A01D 34/13; A01D 34/14; A01D 34/42; A01D 34/43; A01D 34/52; A01D 34/53; A01D 34/73; A01D 34/664; A01D 34/736; B23D 1/00; B23D 15/00; B23D 67/00; B23B 1/00  
See application file for complete search history.

(56) **References Cited**

**U.S. PATENT DOCUMENTS**

2,590,065 A \* 3/1952 Mott ..... A01D 34/535 56/249  
3,388,581 A \* 6/1968 Mercer, Jr. .... A01D 34/736 72/324  
3,485,022 A \* 12/1969 Freedlander ..... A01D 34/73 56/295  
4,936,884 A 6/1990 Campbell  
5,148,660 A 9/1992 Will  
5,383,329 A \* 1/1995 Cornell, III ..... A01D 34/73 56/255  
D357,691 S \* 4/1995 Bryant ..... D15/17  
D438,774 S \* 3/2001 Huang ..... D8/86

(Continued)

**FOREIGN PATENT DOCUMENTS**

CN 202818963 3/2013  
EM 002407619 2/2014

**OTHER PUBLICATIONS**

Bush Hog, Inc., Bush Hog Performance You Can Count On, 2720 Series Flex-Wing Rotary Cutters, Oct. 2013, Bush Hog, Inc., <http://www.bushhog.com>.

(Continued)

*Primary Examiner* — Wan Laymon

*Assistant Examiner* — Clint A Samuel

(74) *Attorney, Agent, or Firm* — Lorenz & Kopf, LLP

(57) **CLAIM**

The ornamental design for a cutting element, as shown and described.

**DESCRIPTION**

FIG. 1 is a left, front, top perspective view of a cutting element according to our new design; FIG. 2 is a front elevation view thereof; FIG. 3 is a rear elevation view thereof; FIG. 4 is a left end view thereof; FIG. 5 is a right end view thereof; FIG. 6 is a top plan view thereof; and, FIG. 7 is a bottom plan view thereof.

The dot-dash line representations in the figures define boundary lines, and the dash line representations in the figures illustrate example environment. The boundary and environmental representations form no part of the claimed design.

The nature of the article is a cutting element, which may take the form of a rotary blade for use in powered agriculture and turf mowing equipment.

**1 Claim, 4 Drawing Sheets**

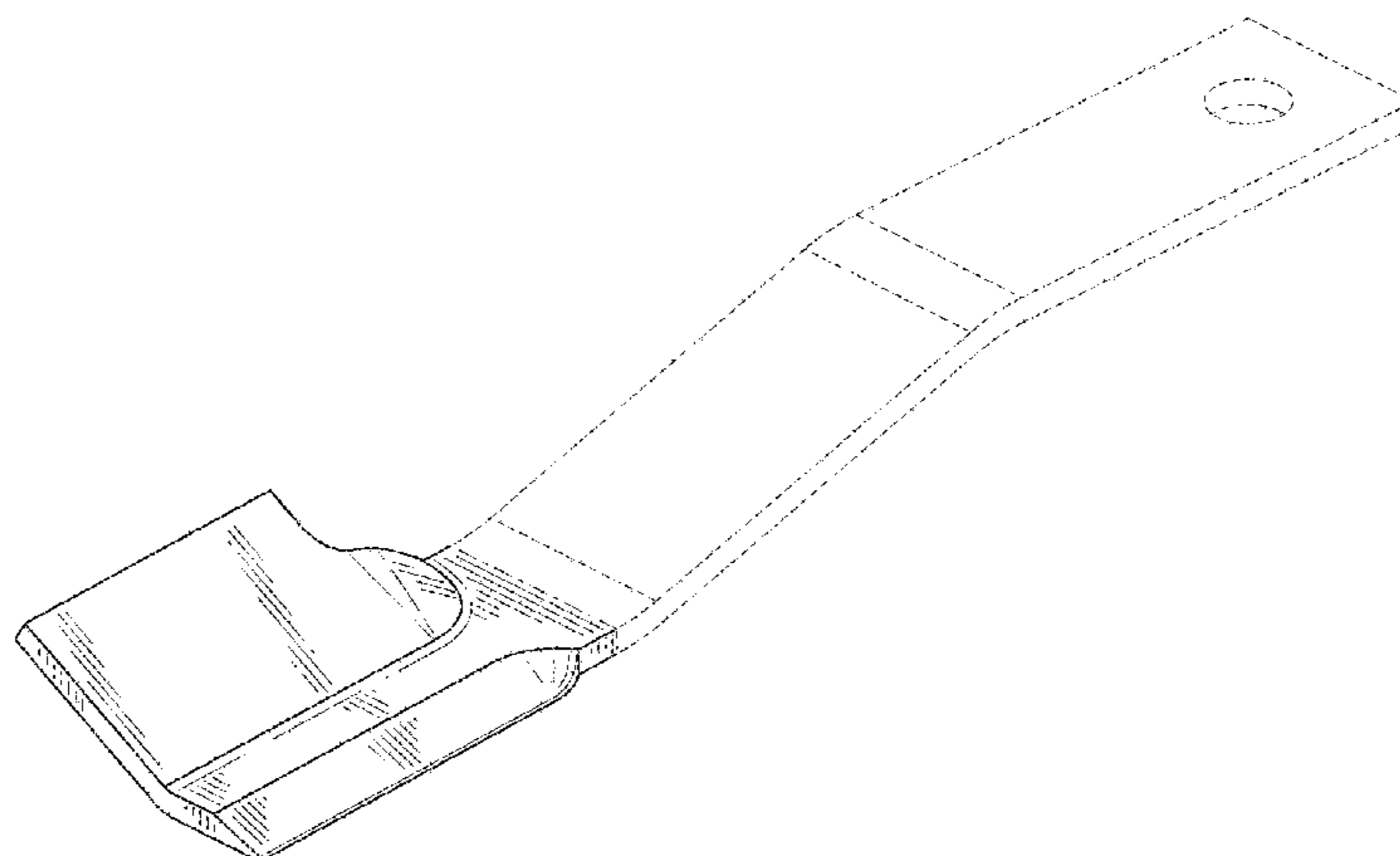

(56)

**References Cited**

U.S. PATENT DOCUMENTS

6,301,868	B1	10/2001	Siplinger	
D526,334	S *	8/2006	Tapper .....	D15/17
D583,642	S *	12/2008	Macor .....	D8/86
D598,475	S	8/2009	Roth	
D649,981	S	12/2011	Roth et al.	
D759,126	S *	6/2016	Johnson .....	A01D 34/736 D15/17
D766,332	S *	9/2016	Poole .....	D15/17
D781,351	S *	3/2017	Upham .....	A01D 34/73 D15/17
D795,036	S *	8/2017	Macor .....	D8/86
2012/0198807	A1	8/2012	Upham	
2014/0182257	A1 *	7/2014	von Rentzell .....	A01D 34/73 56/289

OTHER PUBLICATIONS

Land Pride, RC6615 15' Folding Rotary Cutter, Nothing Stands in Our Way!, <http://www.landpride.com>.  
 Schulte Industries Ltd., OEM . . . There Is a Difference Rotary Cutter Blades, <http://www.schulte.ca>.  
 Woods Equipment, Blount International, Rotary Cutters, Pub. 2013, <http://www.woodsequipment.com/rotaryCutters.aspx>.  
 Spearhead Machinery, <http://www.spearheadmachinery.com/products/wingmowers/StubbleMaster500/default.aspx>.  
 John Deere, Rotary Cutters, Standard-Duty, Mid Duty, Heavy Duty and Commercial Duty, Mar. 2016.

\* cited by examiner

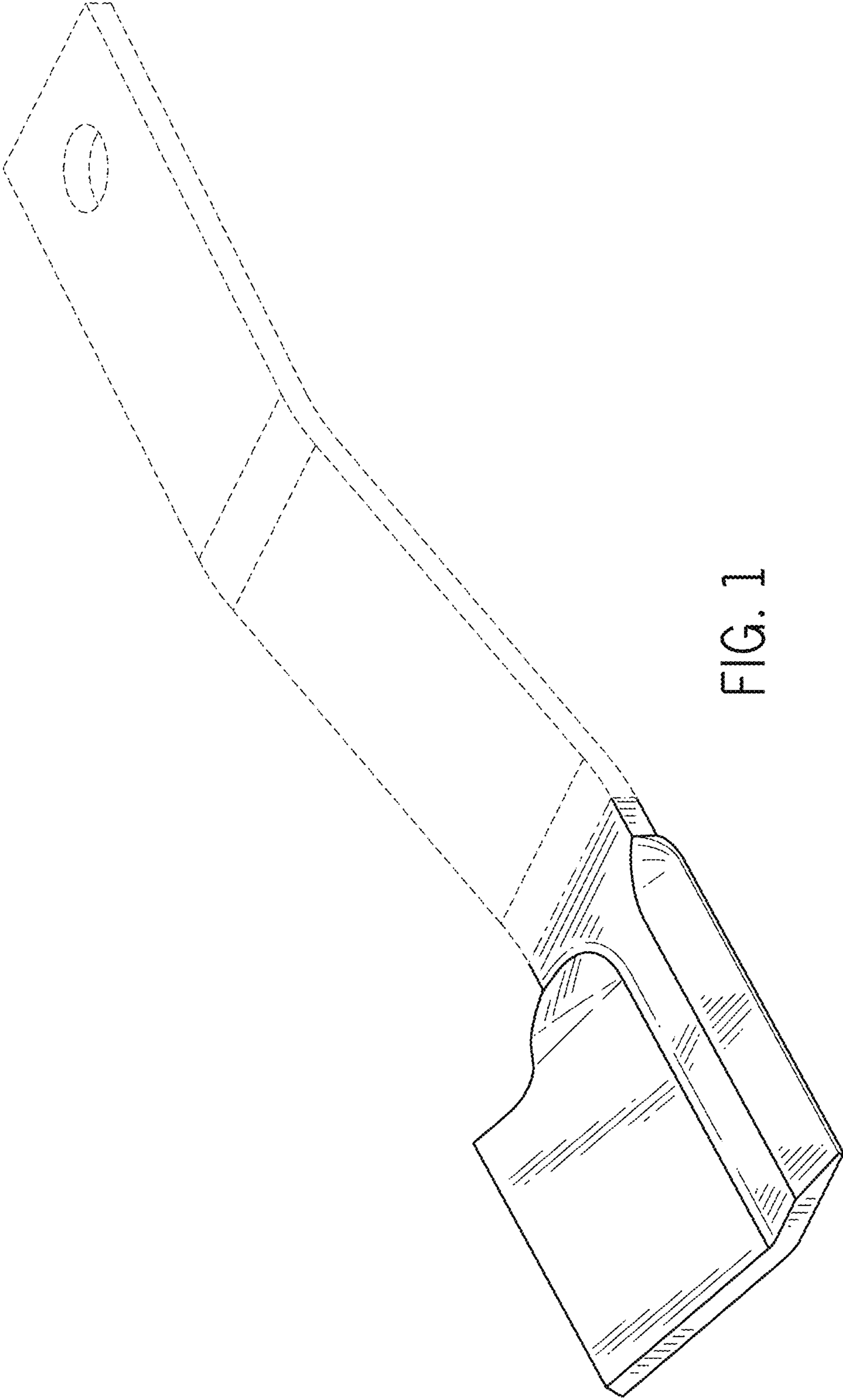

FIG. 1

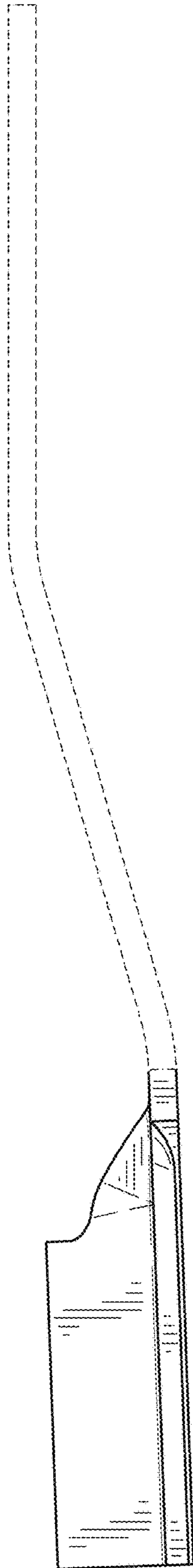

FIG. 2

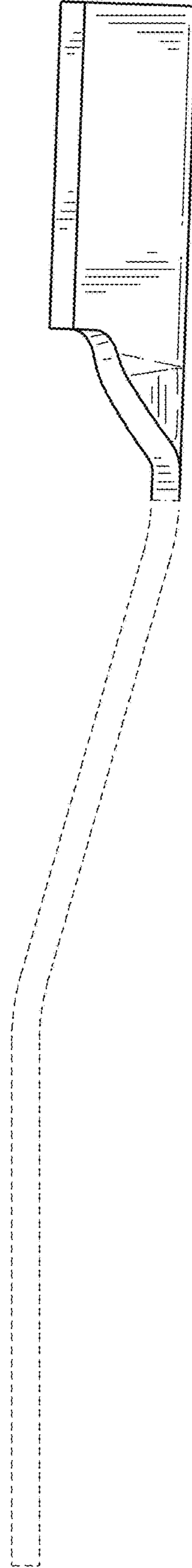

FIG. 3

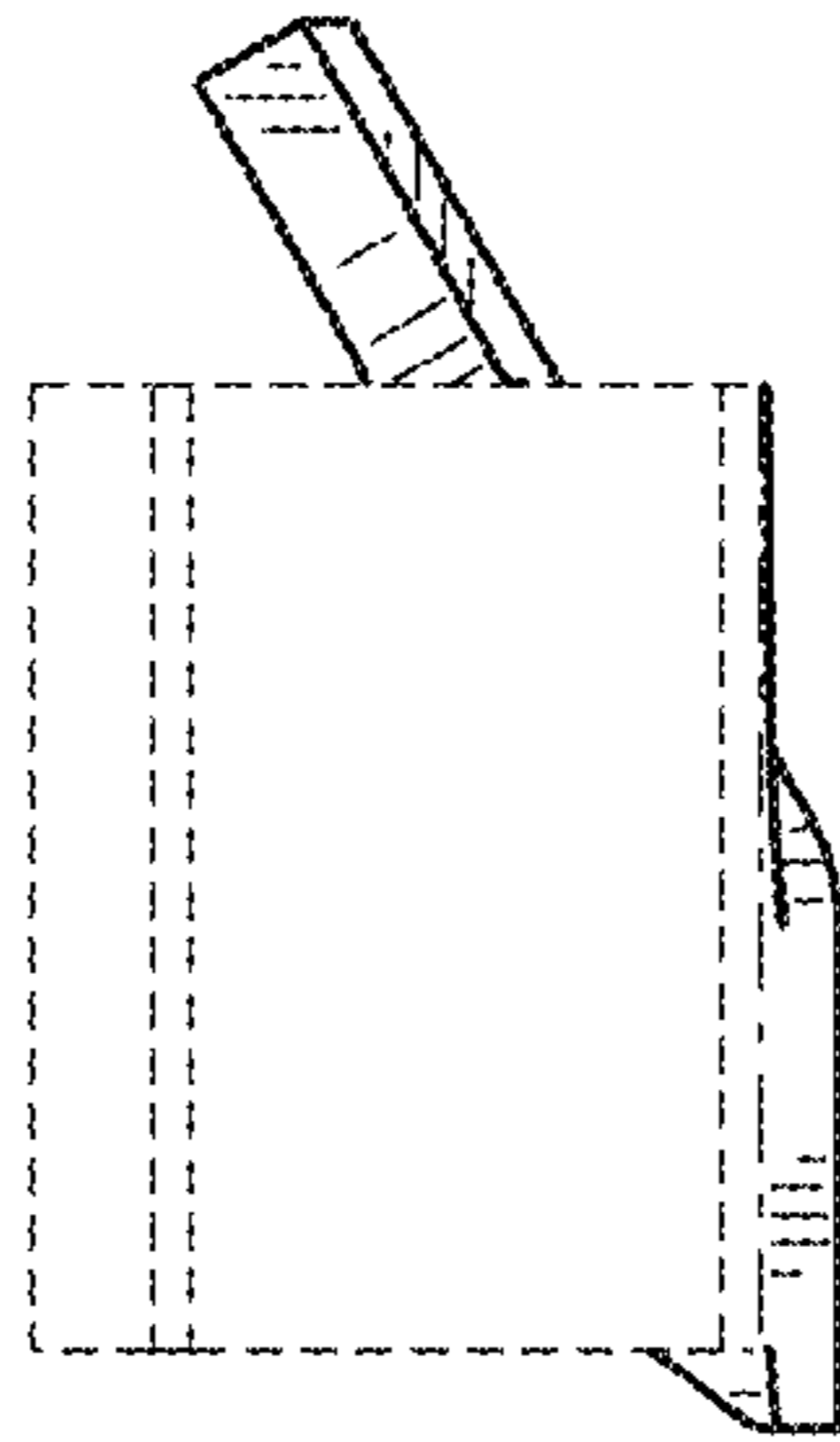

FIG. 5

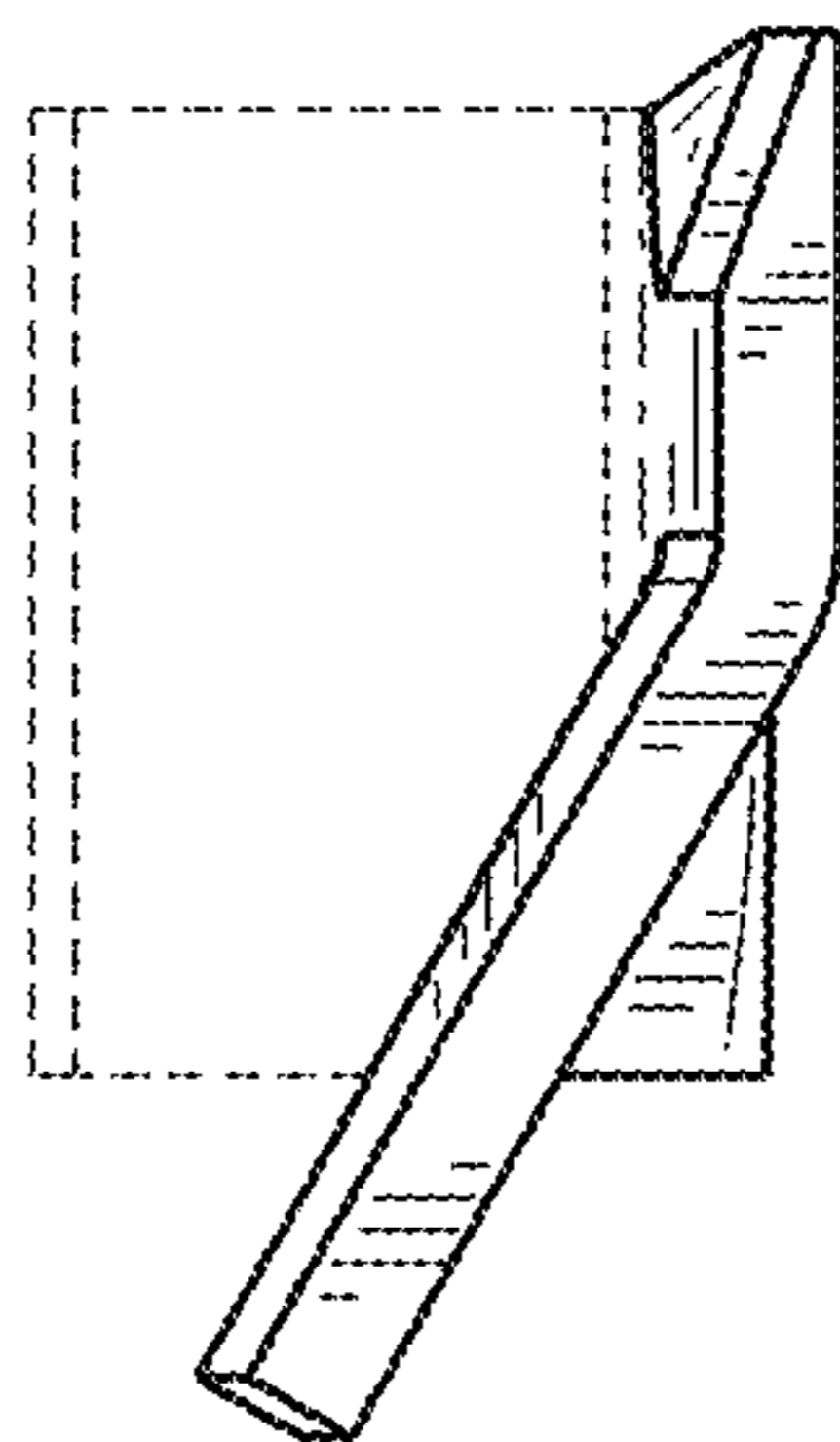

FIG. 4

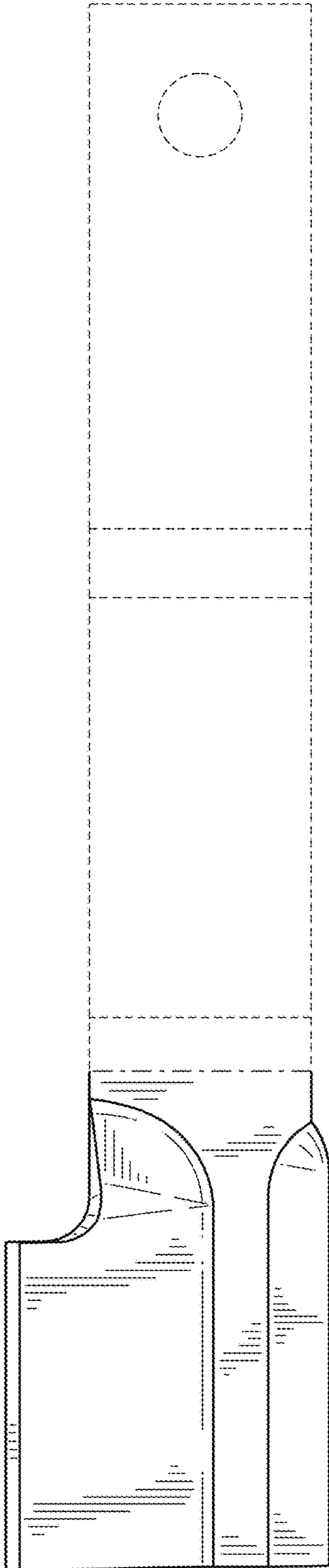

FIG. 6

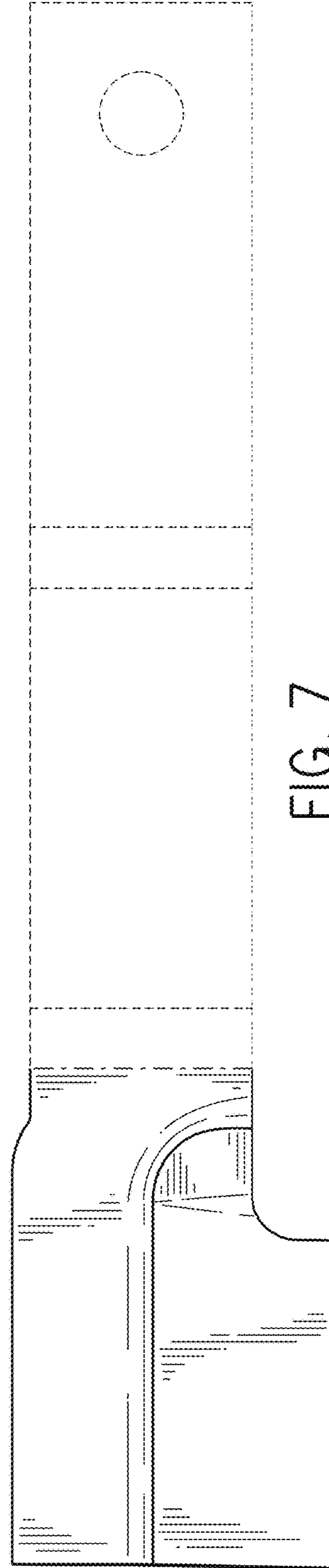

FIG. 7