



US00D812429S

(12) **United States Design Patent**
McLaughlin

(10) **Patent No.:** **US D812,429 S**
(45) **Date of Patent:** **** Mar. 13, 2018**

(54) **DRINKING VESSEL**

(74) *Attorney, Agent, or Firm* — Lathrop Gage LLP

(71) Applicant: **Making Modern LLC**, Lyons, CO
(US)

(57) **CLAIM**

The ornamental design for a drinking vessel, as shown and described.

(72) Inventor: **Jon Reeves McLaughlin**, Lyons, CO
(US)

DESCRIPTION

(73) Assignee: **Making Modern LLC**, Lyons, CO
(US)

FIG. 1 is a top perspective view of a first embodiment of a drinking vessel showing my new design;

(**) Term: **15 Years**

FIG. 2 is a top perspective view of a second embodiment of a drinking vessel;

(21) Appl. No.: **29/612,278**

FIG. 3 is a top perspective view of a third embodiment of a drinking vessel;

(22) Filed: **Jul. 31, 2017**

FIG. 4 is a top perspective view of a fourth embodiment of a drinking vessel;

Related U.S. Application Data

FIG. 5 is a front elevational view of FIG. 1;

(62) Division of application No. 29/592,793, filed on Feb. 2, 2017.

FIG. 6 is a front elevational view of FIG. 2;

(51) **LOC (11) Cl.** **07-01**

FIG. 7 is a front elevational view of FIG. 3;

(52) **U.S. Cl.**

FIG. 8 is a front elevational view of FIG. 4;

USPC **D7/523**; D7/505; D7/532

FIG. 9 is a rear elevational view of FIG. 1;

(58) **Field of Classification Search**

FIG. 10 is a rear elevational view of FIG. 2;

USPC D7/505, 507, 509, 510, 511, 512, 151,

FIG. 11 is a rear elevational view of FIG. 3;

D7/523, 532, 392.1, 396.2; 220/495.03,

FIG. 12 is a rear elevational view of FIG. 4;

220/592.16, 592.17; D11/143, 144

FIG. 13 is a side elevational view of FIG. 1;

CPC A47G 19/2272; A47G 19/2227; A47G

FIG. 14 is a side elevational view of FIG. 2;

19/22; A45F 3/20; A45F 3/16; B65D

FIG. 15 is a side elevational view of FIG. 3;

47/066; B65D 1/265

FIG. 16 is a side elevational view of FIG. 4;

See application file for complete search history.

FIG. 17 is a top plan view of FIG. 1;

FIG. 18 is a top plan view of FIG. 2;

FIG. 19 is a top plan view of FIG. 3;

FIG. 20 is a top plan view of FIG. 4;

FIG. 21 is a bottom plan view of FIG. 1;

FIG. 22 is a bottom plan view of FIG. 2;

FIG. 23 is a bottom plan view of FIG. 3;

FIG. 24 is a bottom plan view of FIG. 4;

FIG. 25 is a bottom front perspective view of FIG. 1;

FIG. 26 is a bottom front perspective view of FIG. 2;

FIG. 27 is a bottom front perspective view of FIG. 3; and,

FIG. 28 is a bottom front perspective view of FIG. 4.

(56) **References Cited**

U.S. PATENT DOCUMENTS

D113,508 S * 2/1939 Gross D7/507

D193,362 S * 8/1962 Groff D7/511

(Continued)

Primary Examiner — Marianne Pandozzi

Assistant Examiner — Jae Liang

1 Claim, 6 Drawing Sheets

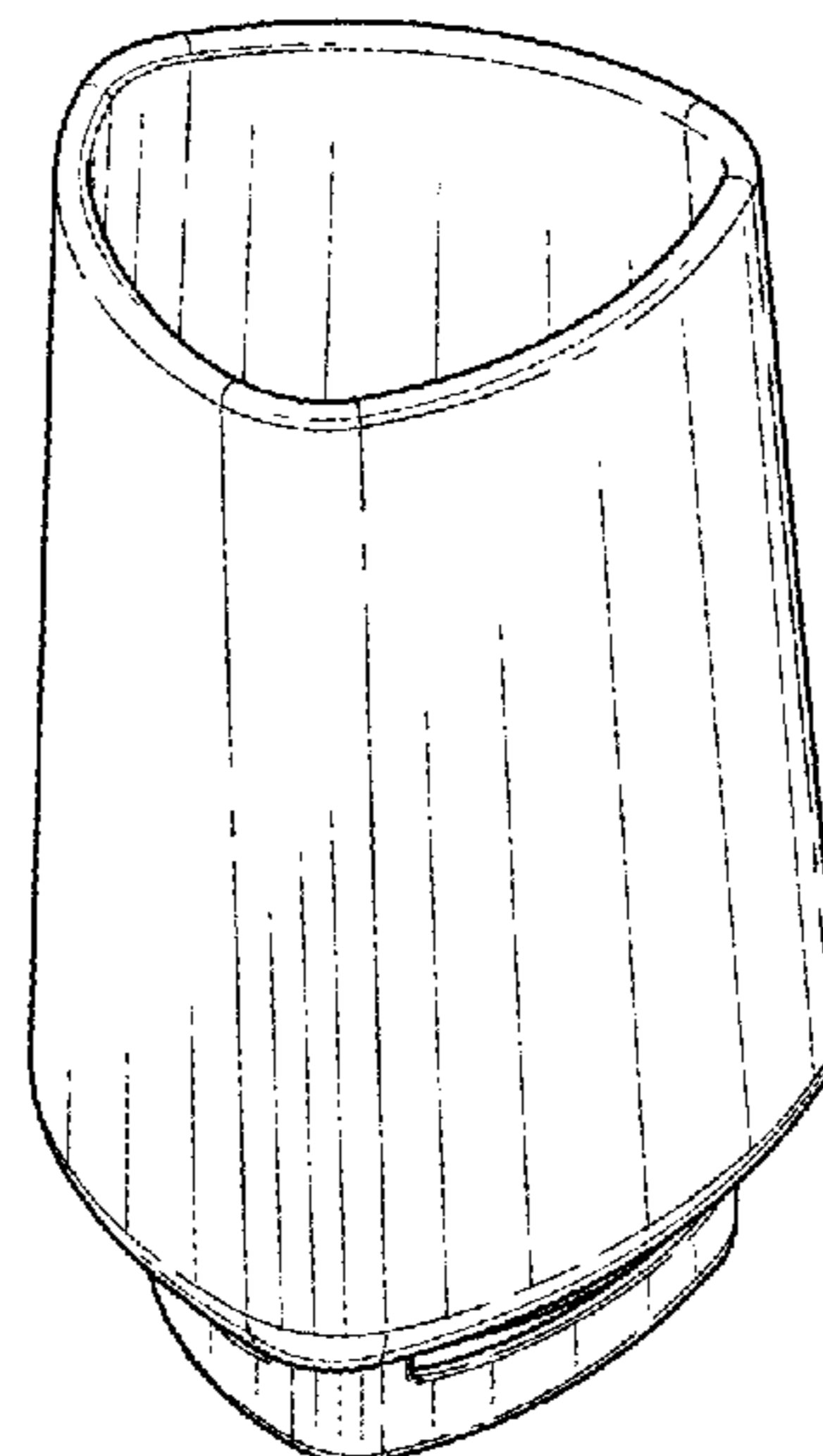
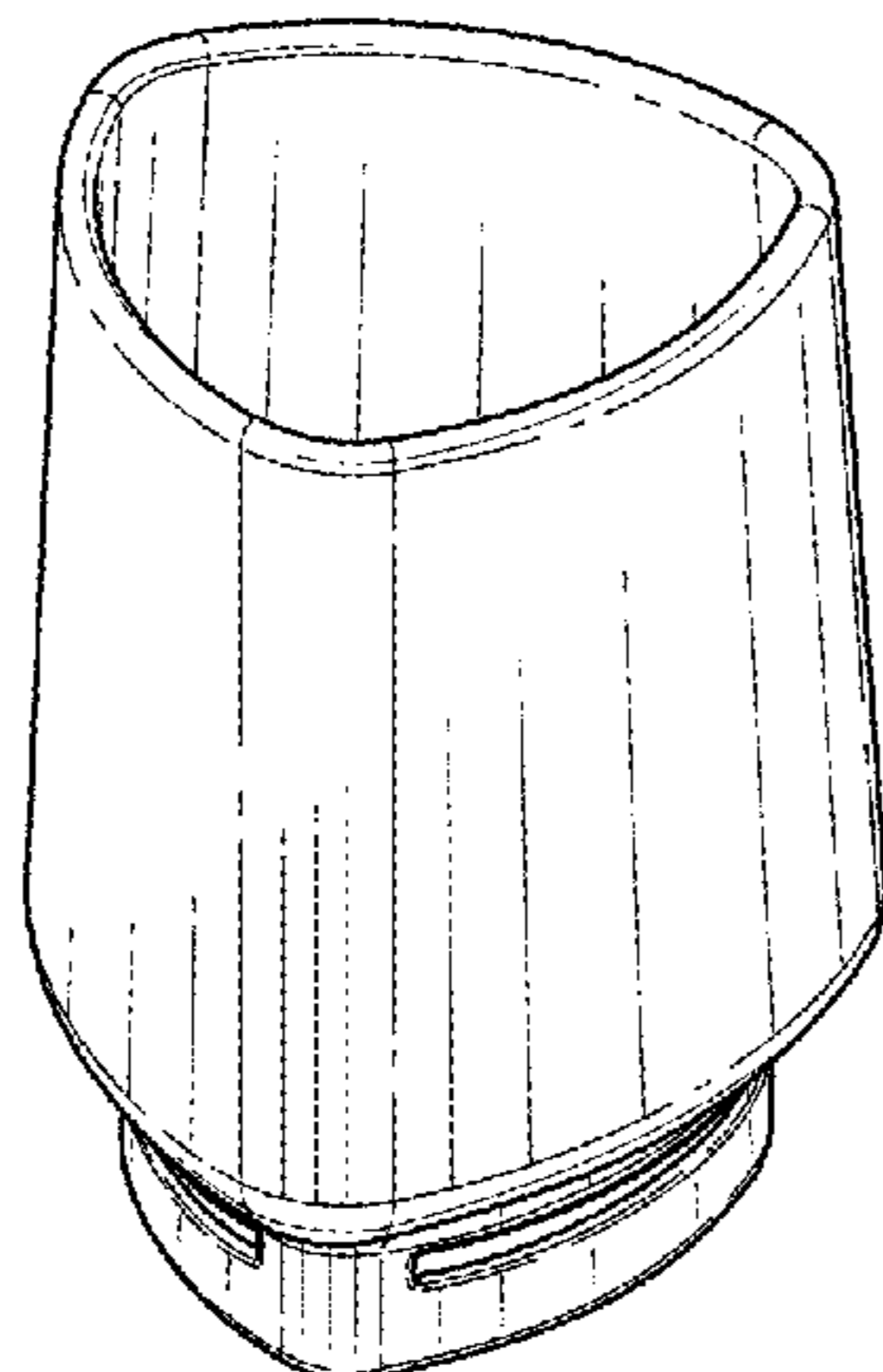

(56)

References Cited

U.S. PATENT DOCUMENTS

3,137,431 A * 6/1964 Crouse B65D 3/02
 229/4.5
 D282,232 S * 1/1986 Bussell D7/509
 4,614,280 A * 9/1986 Wightman A47G 19/12
 220/610
 D288,766 S * 3/1987 Tardif D7/523
 D314,689 S * 2/1991 Claudias D10/2
 D331,173 S * 11/1992 Durand D7/507
 D335,728 S * 5/1993 Dziersk D34/1
 D340,385 S * 10/1993 Durand D7/509
 D382,446 S * 8/1997 Bacon D7/509
 D399,392 S * 10/1998 Husted D7/510
 D410,124 S * 5/1999 Nilsson D34/1
 D424,378 S * 5/2000 Bacon D7/602
 D441,609 S * 5/2001 Hsu D7/523
 D442,861 S * 5/2001 Sagel D9/430
 D462,293 S * 9/2002 Bates D11/143
 D462,294 S * 9/2002 Walsh D11/143
 D498,979 S * 11/2004 Bhavnani D7/510
 D508,372 S * 8/2005 Martinez-Lopez D7/509
 D533,402 S * 12/2006 Bin D7/510

D536,148 S * 1/2007 Schiefer D34/1
 D556,054 S * 11/2007 Stephens D9/734
 D557,074 S * 12/2007 Bardolet D7/509
 D558,444 S * 1/2008 Ma D3/6
 D559,433 S * 1/2008 Mackey D26/128
 D568,104 S * 5/2008 Bhavnani D7/509
 D574,190 S * 8/2008 Homma D7/510
 D574,192 S * 8/2008 Schosser D7/509
 D578,927 S * 10/2008 Brandstatter D11/146
 D583,624 S * 12/2008 Silvers D7/396.2
 D586,622 S * 2/2009 Silvers D7/509
 D587,527 S * 3/2009 Wolhendler D7/509
 D622,548 S * 8/2010 Jensen D7/509
 D651,248 S * 12/2011 Yuan D19/85
 D659,586 S * 5/2012 Brandstatter D11/155
 D663,163 S * 7/2012 Dick D7/507
 D667,151 S * 9/2012 Arslanian D26/9
 D673,812 S * 1/2013 Hauser D7/523
 D679,545 S * 4/2013 Wolhendler D7/510
 D705,608 S * 5/2014 Wolhendler D7/509
 D708,481 S * 7/2014 Lin D7/523
 2006/0124651 A1 * 6/2006 Bhavnani A47J 41/0016
 220/592.17

* cited by examiner

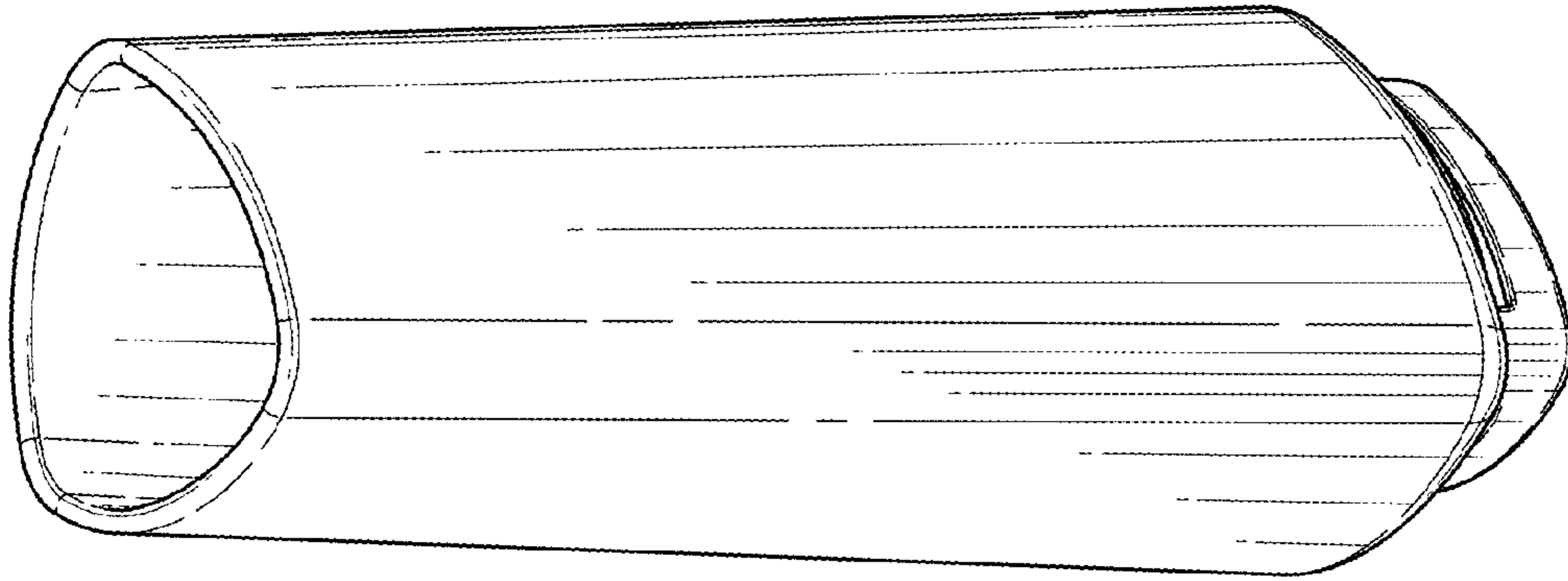

FIG. 4

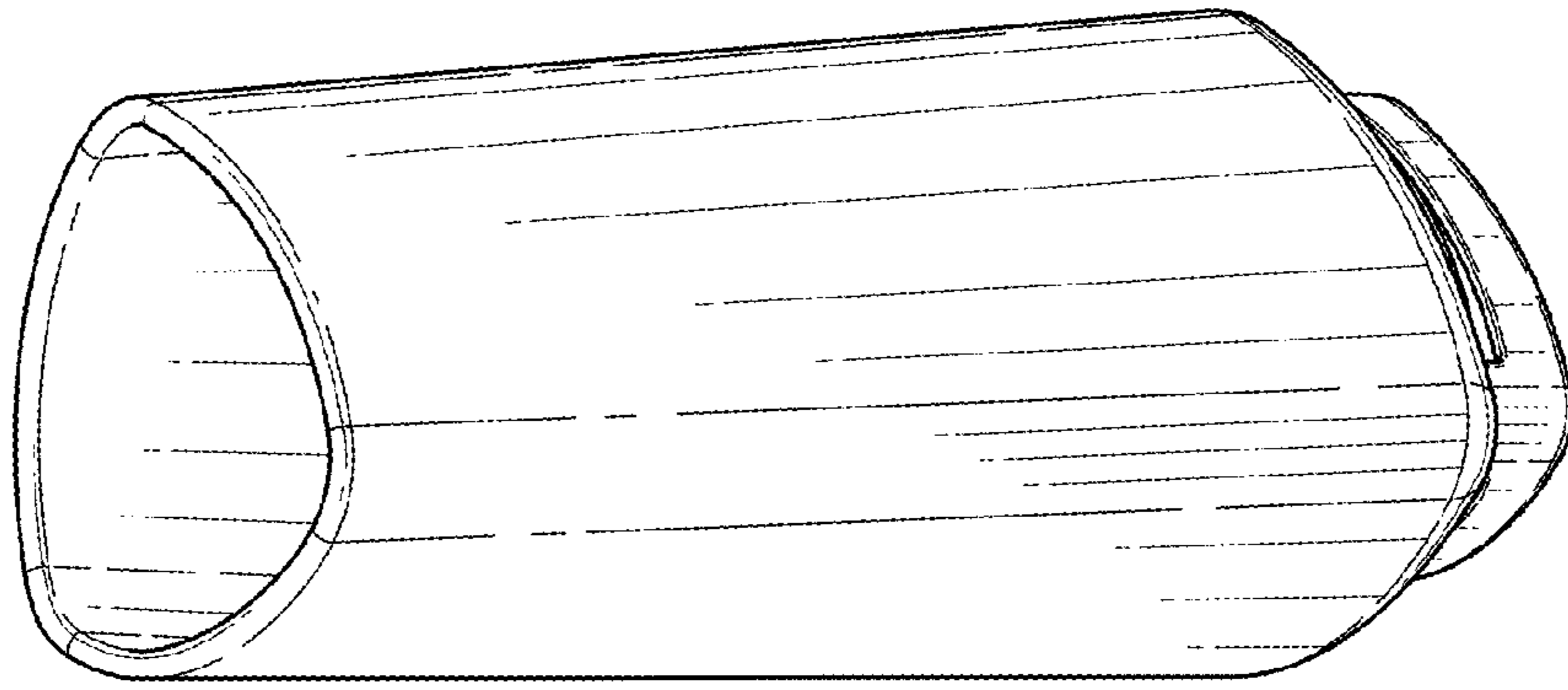

FIG. 3

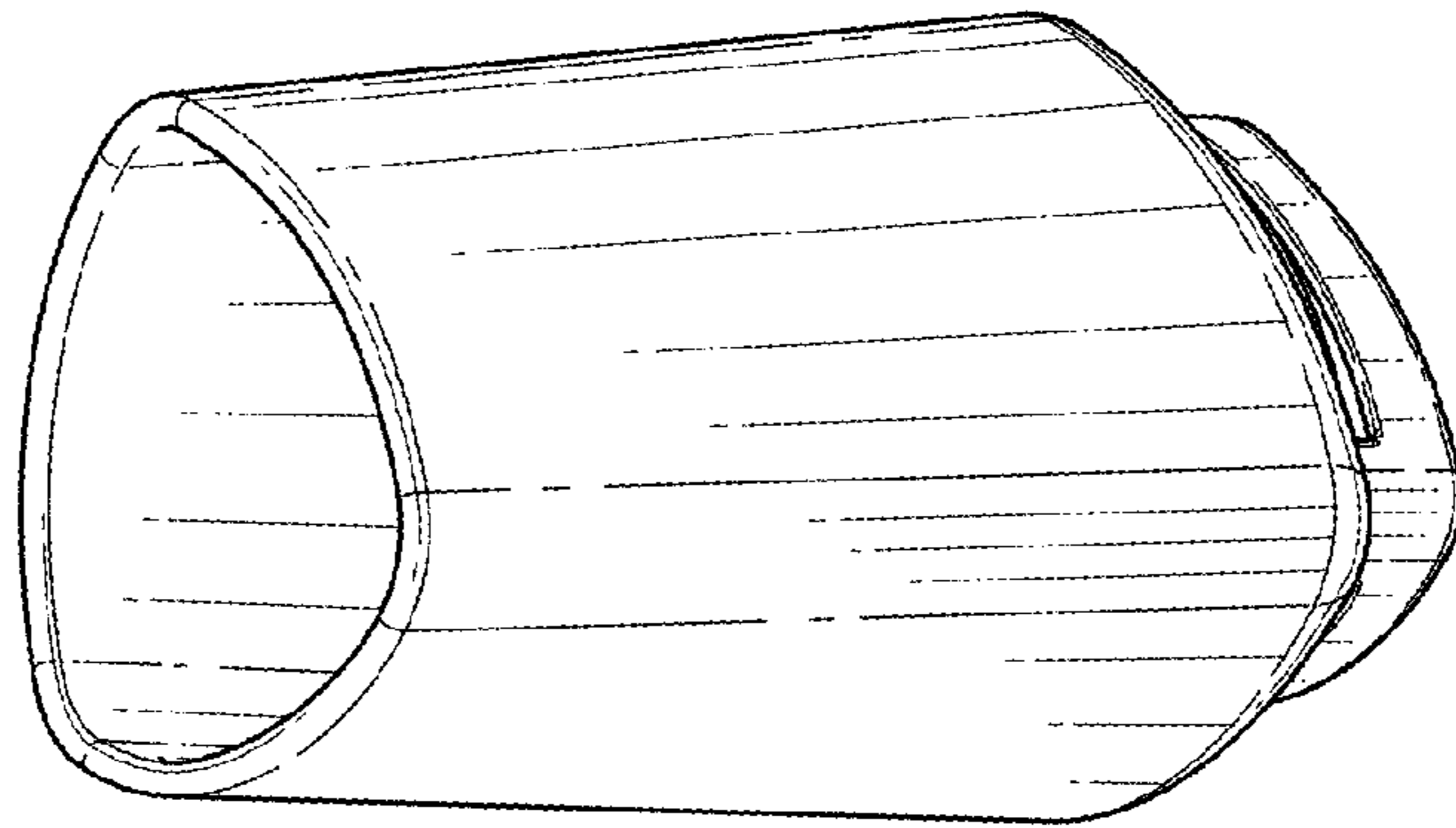

FIG. 2

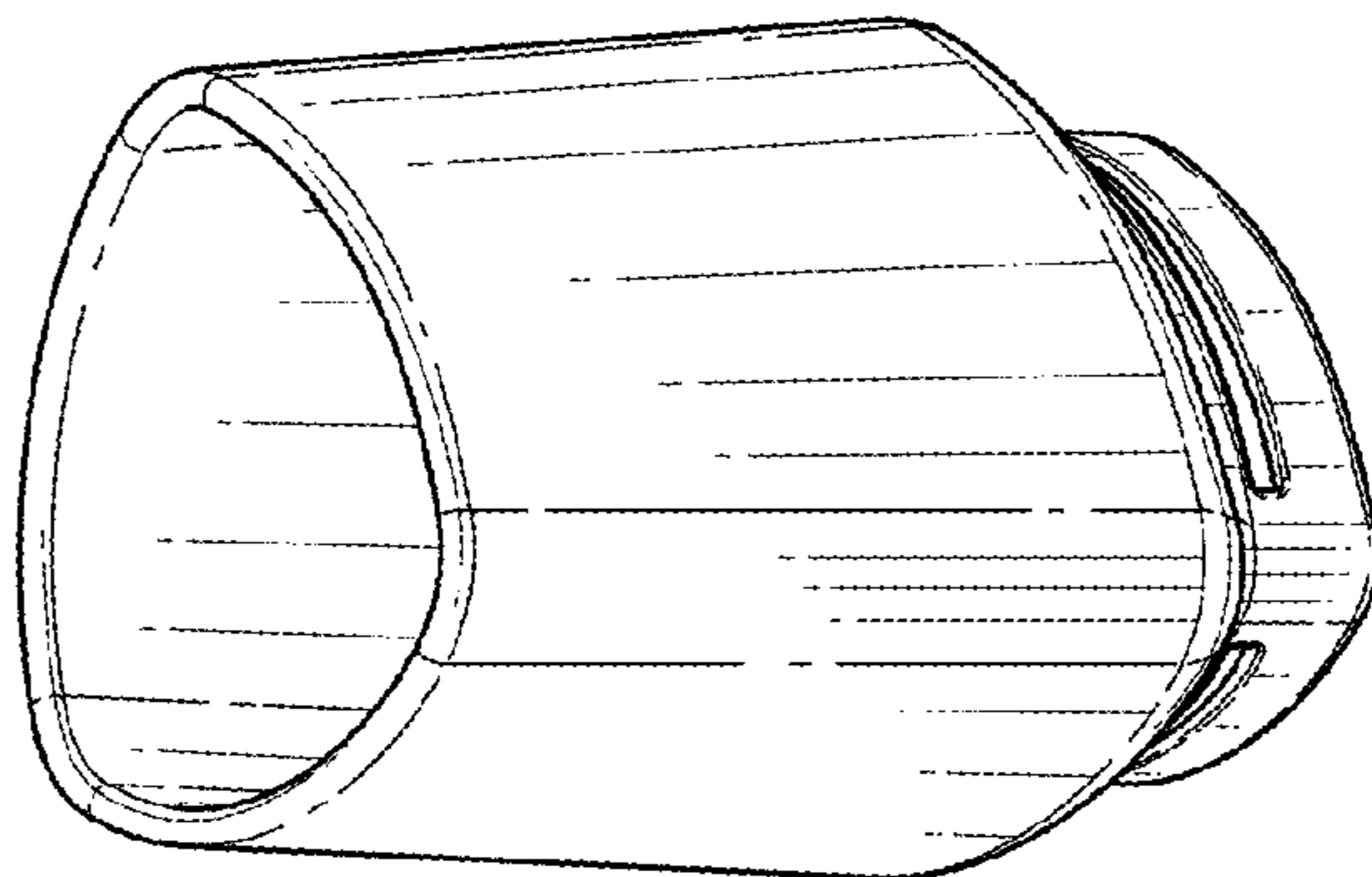

FIG. 1

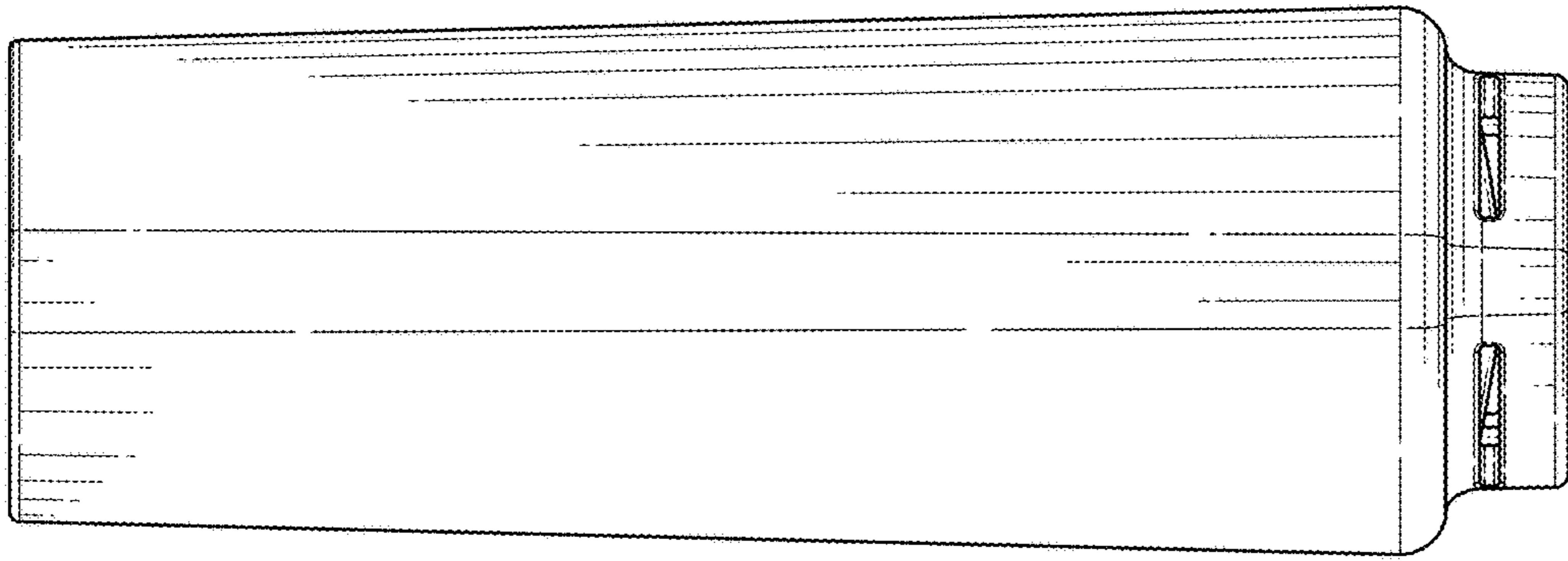

FIG. 8

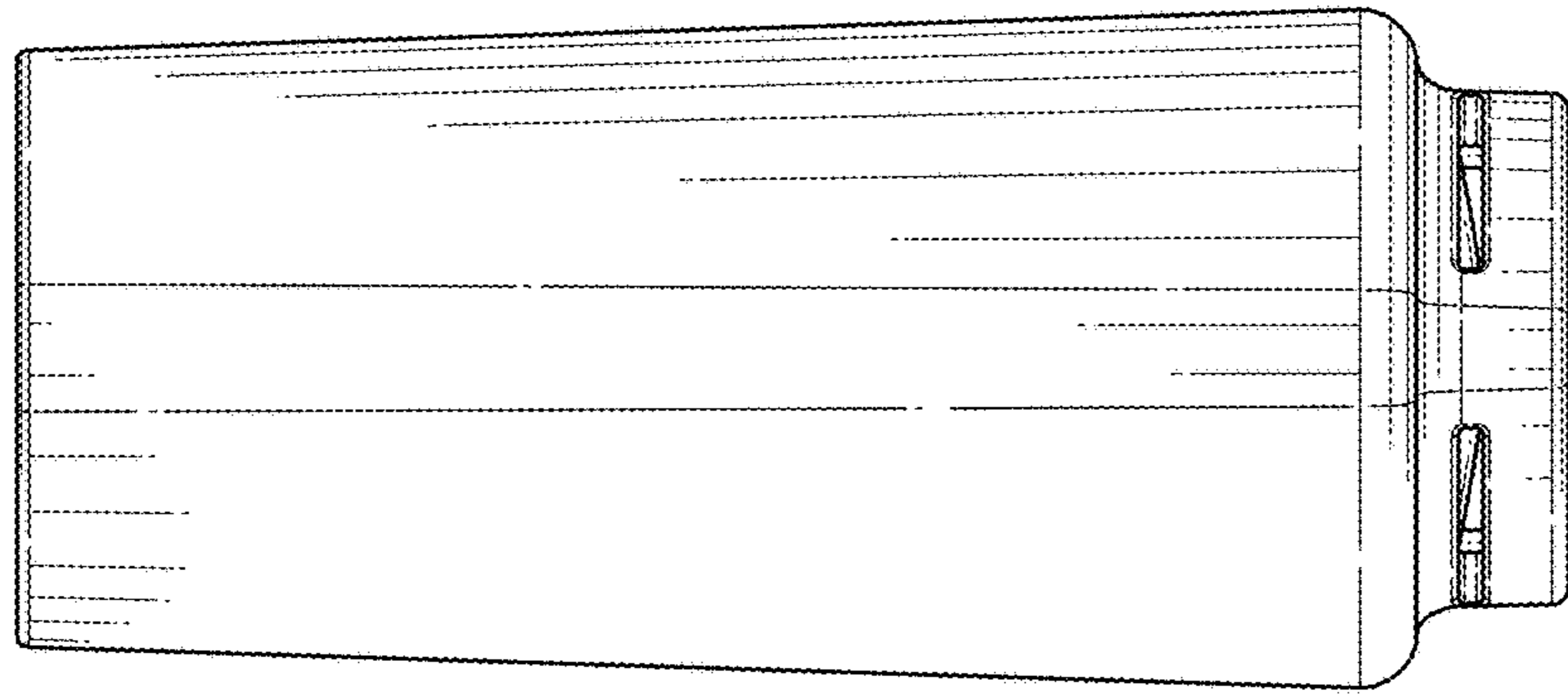

FIG. 7

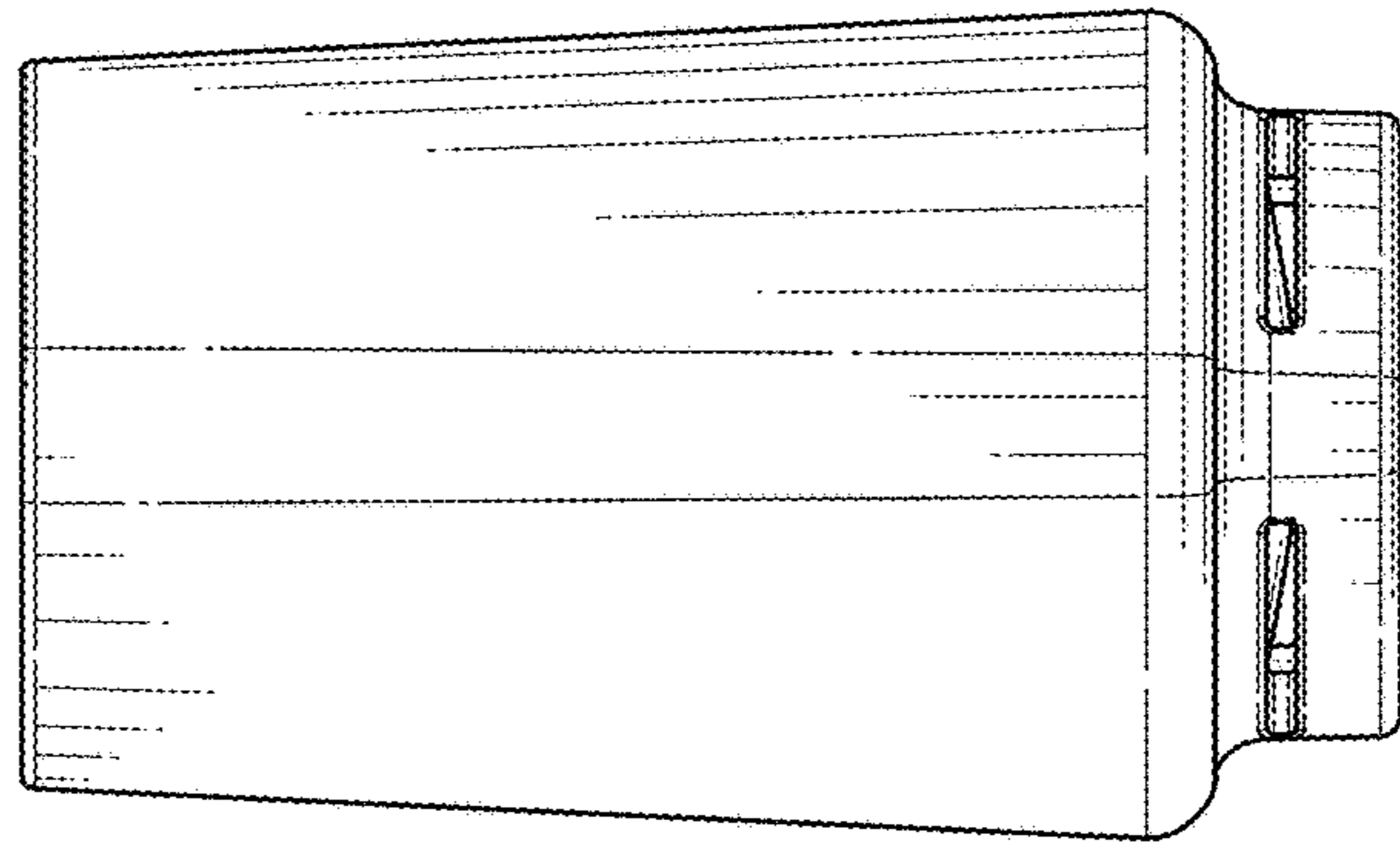

FIG. 6

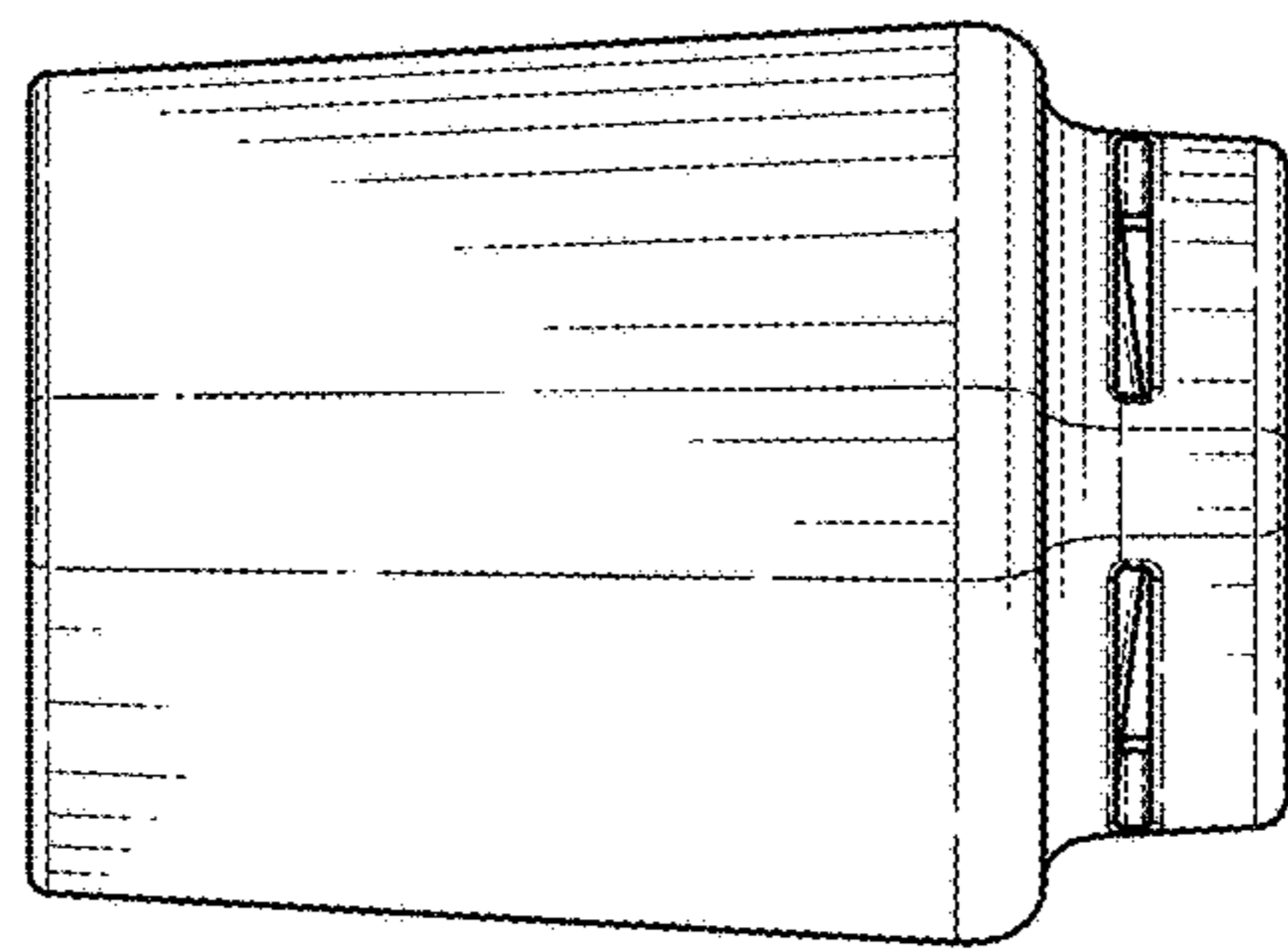

FIG. 5

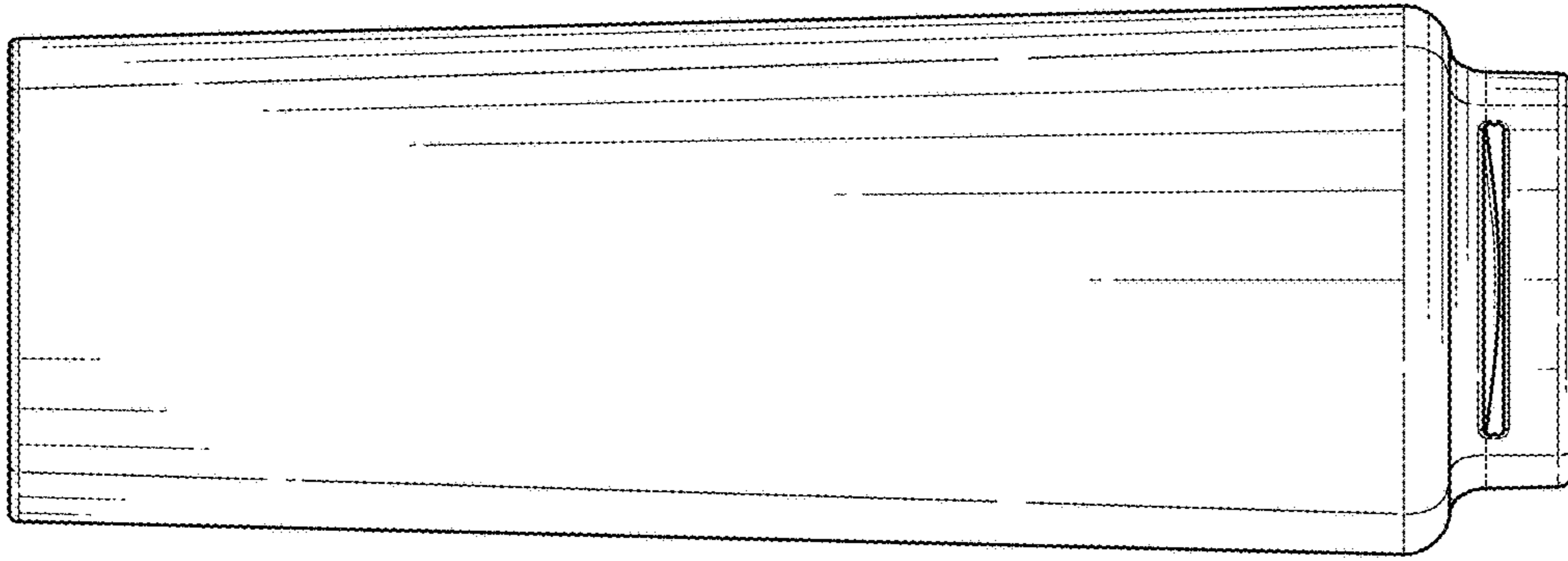

FIG. 12

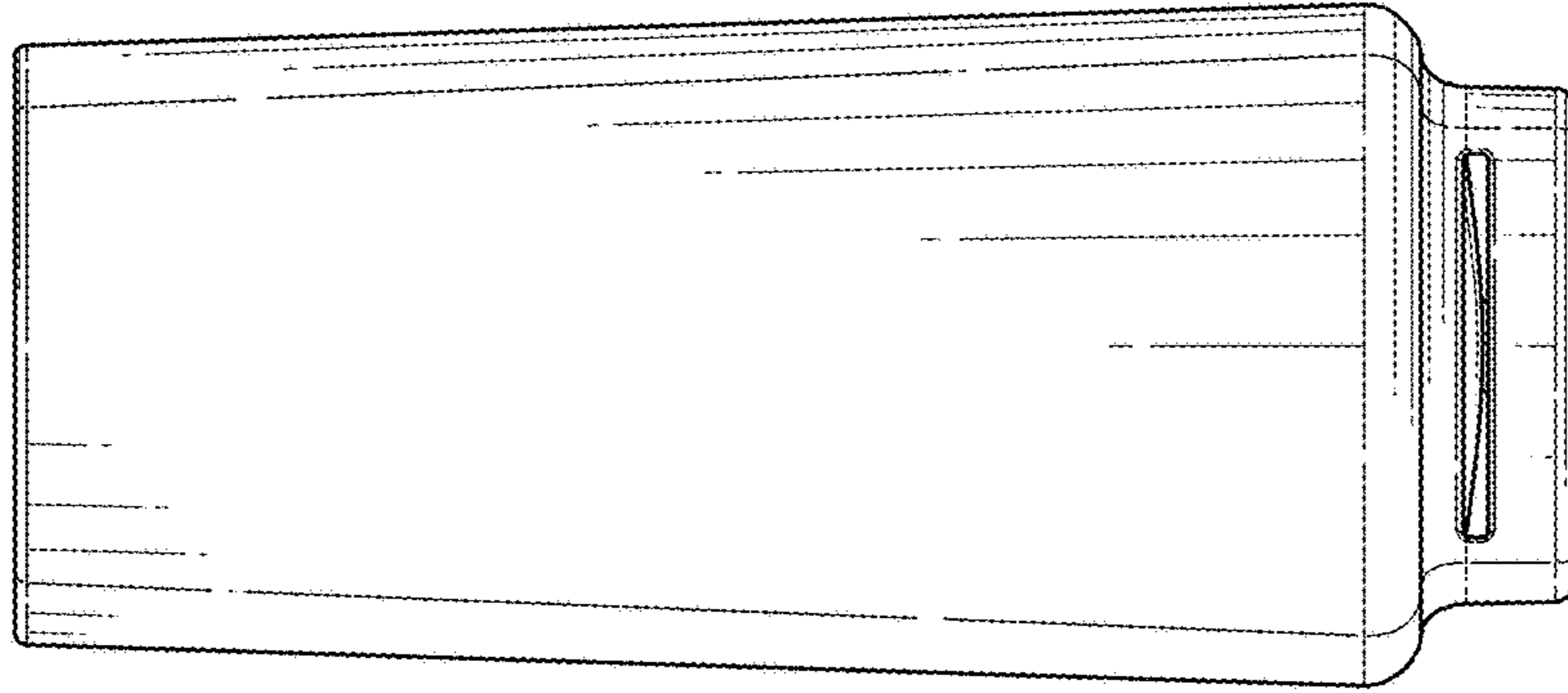

FIG. 11

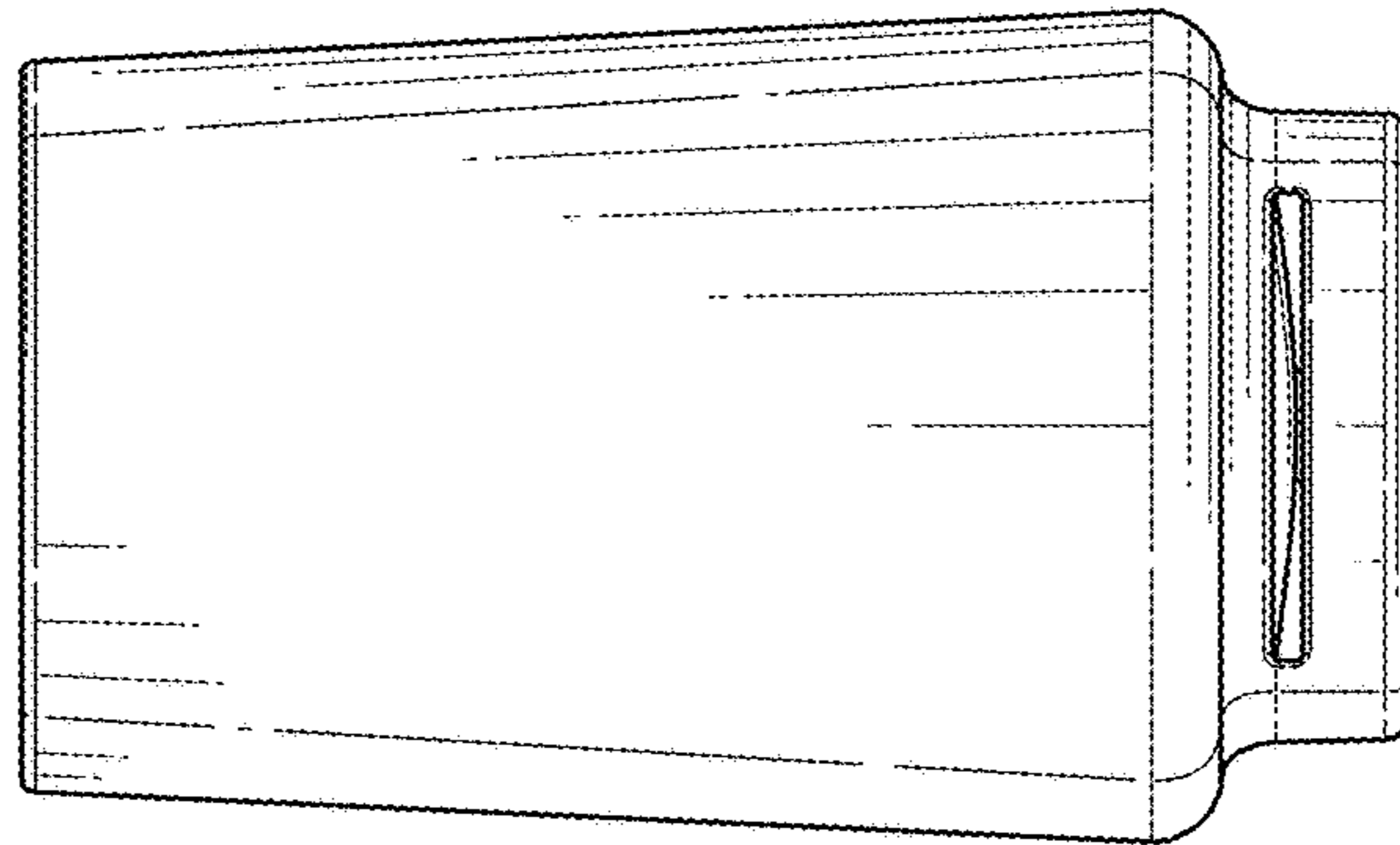

FIG. 10

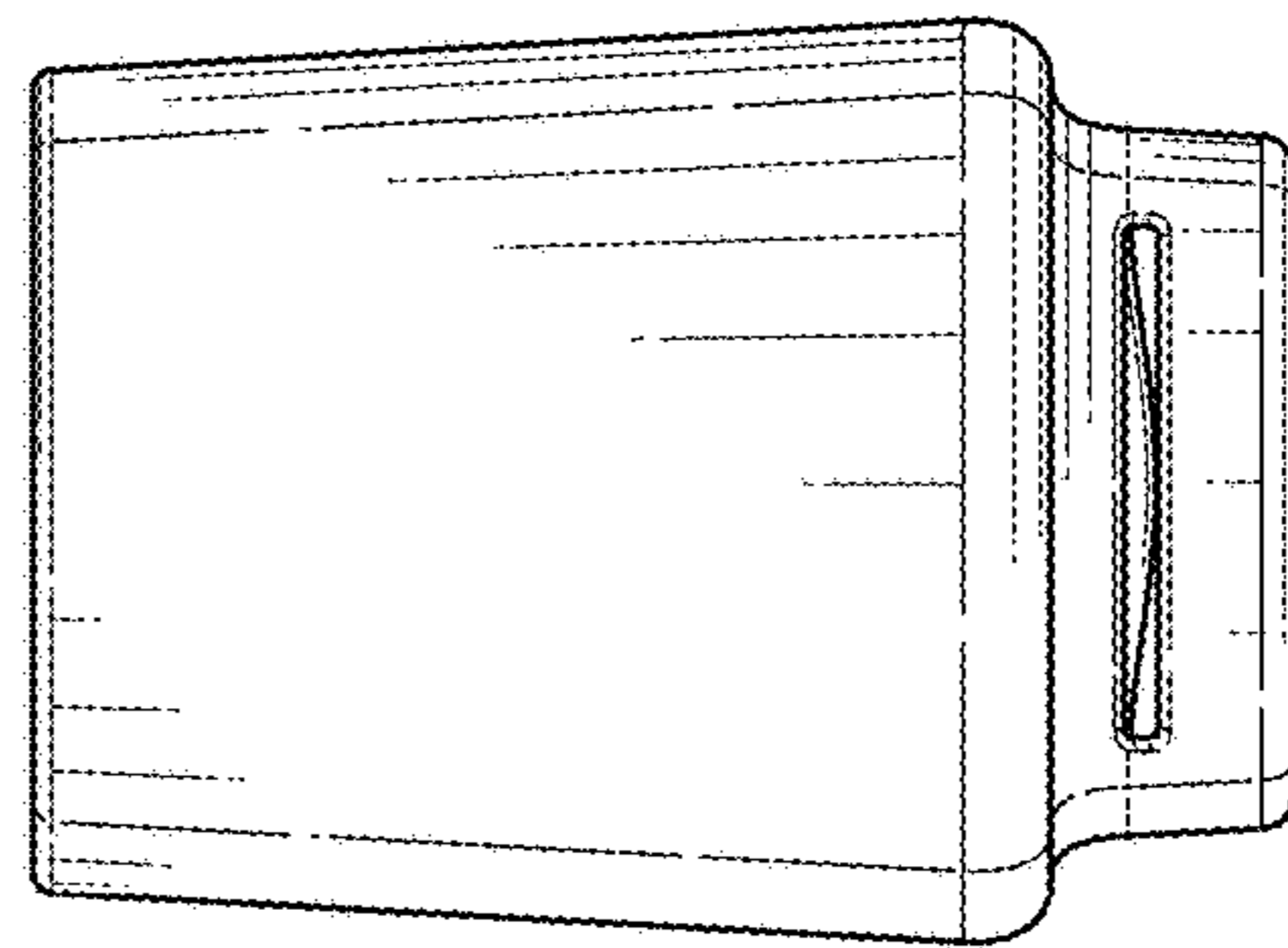

FIG. 9

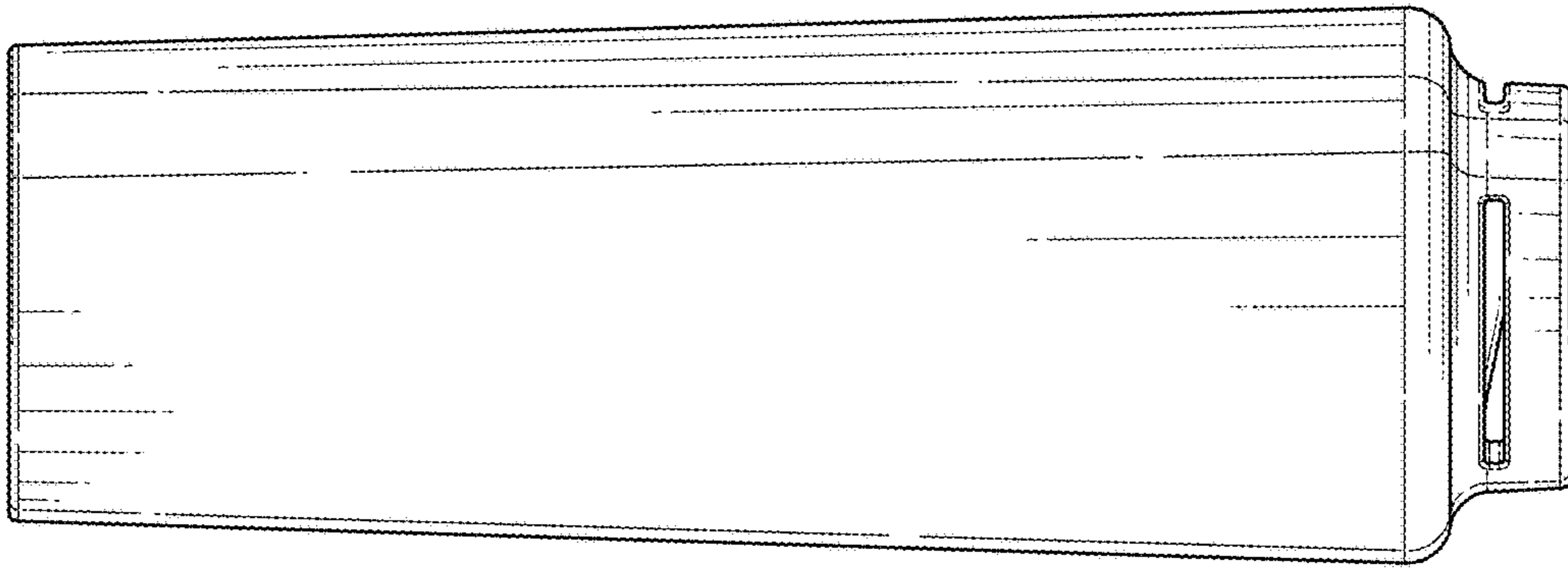

FIG. 16

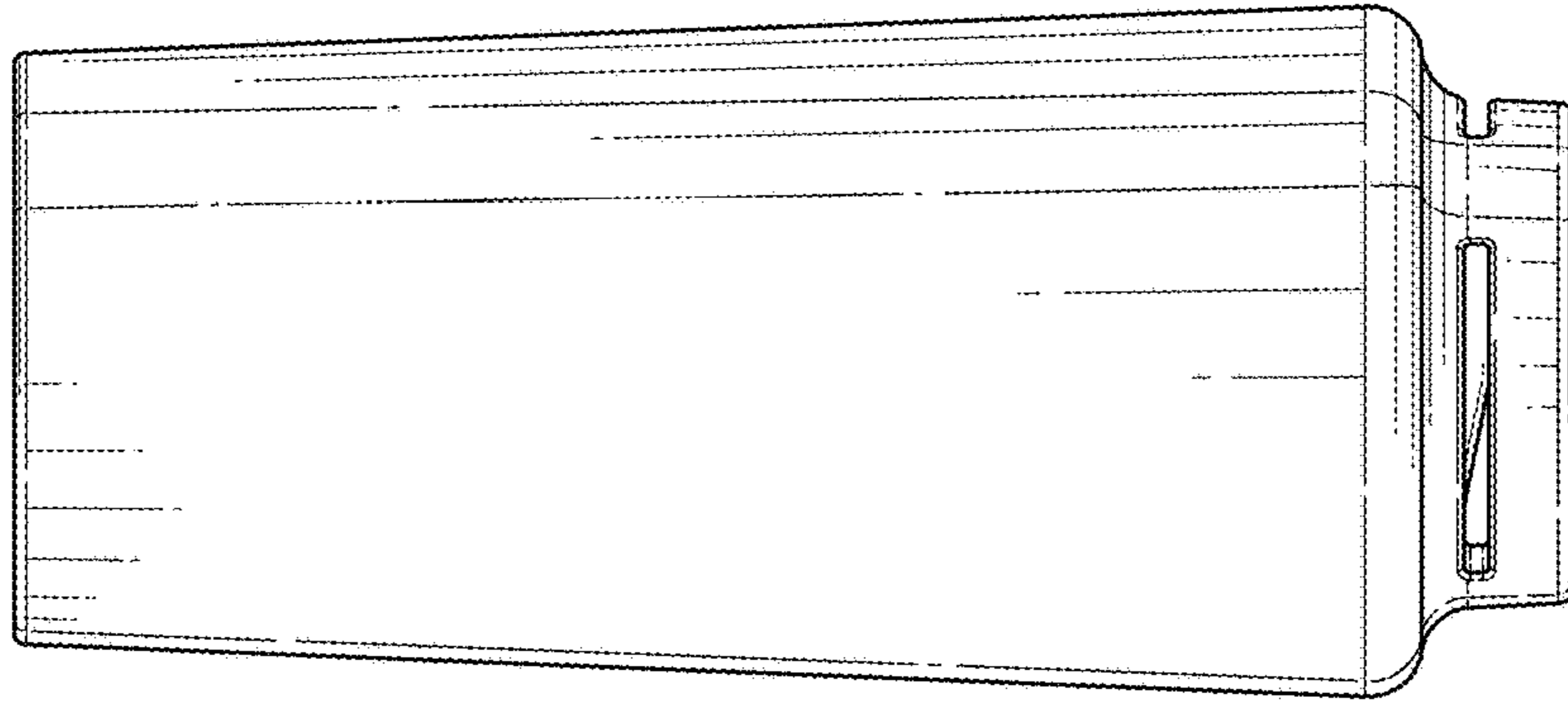

FIG. 15

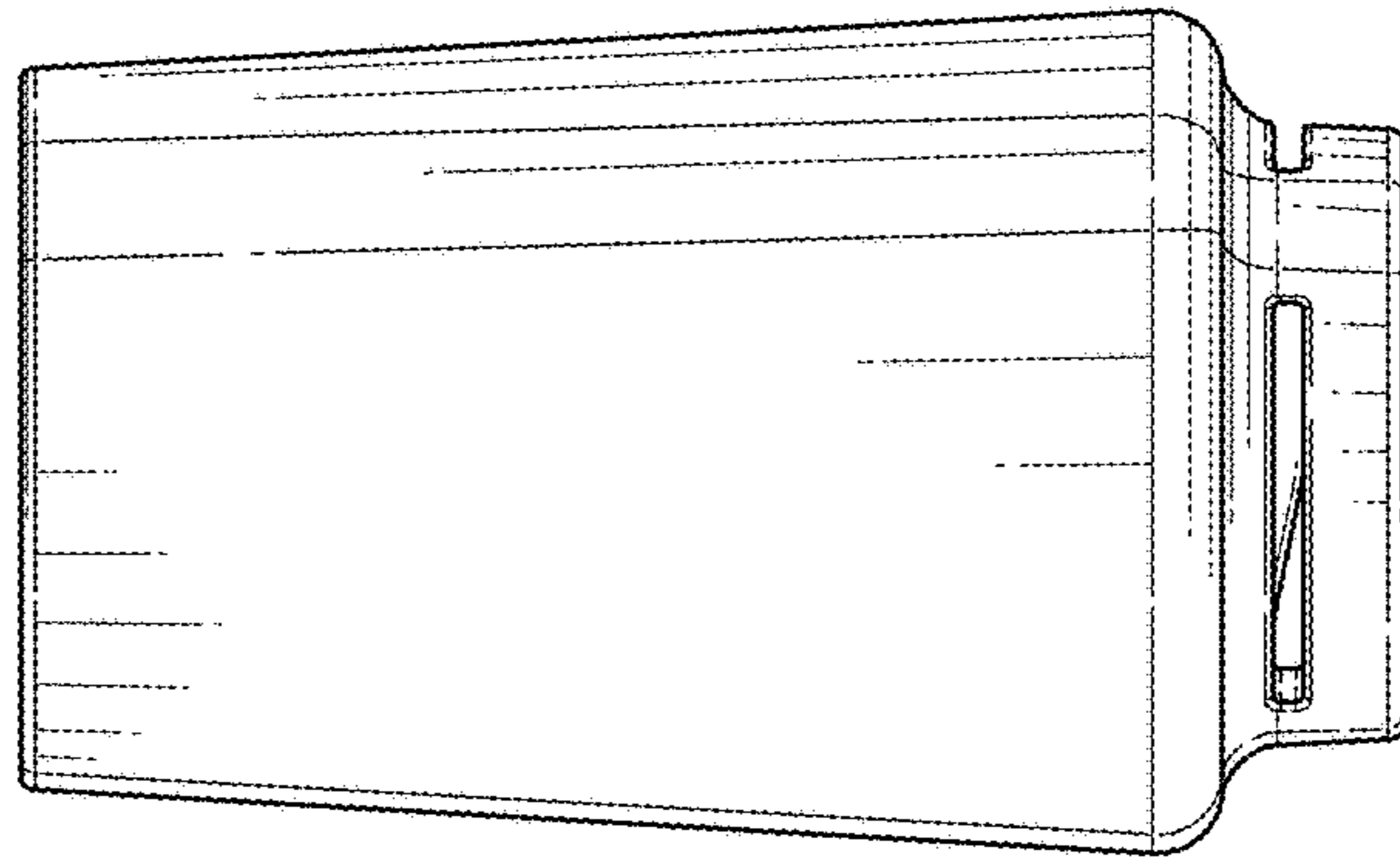

FIG. 14

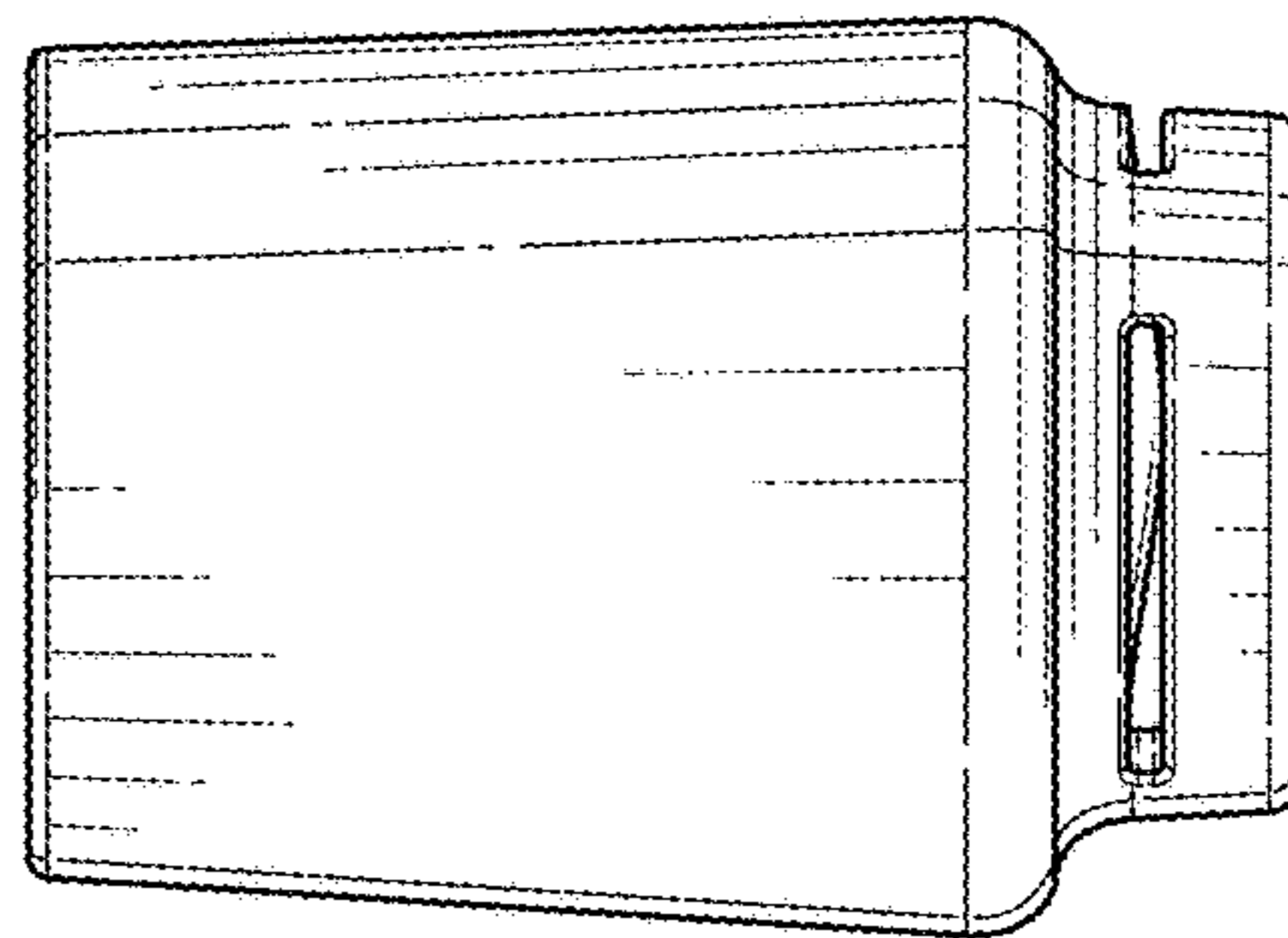

FIG. 13

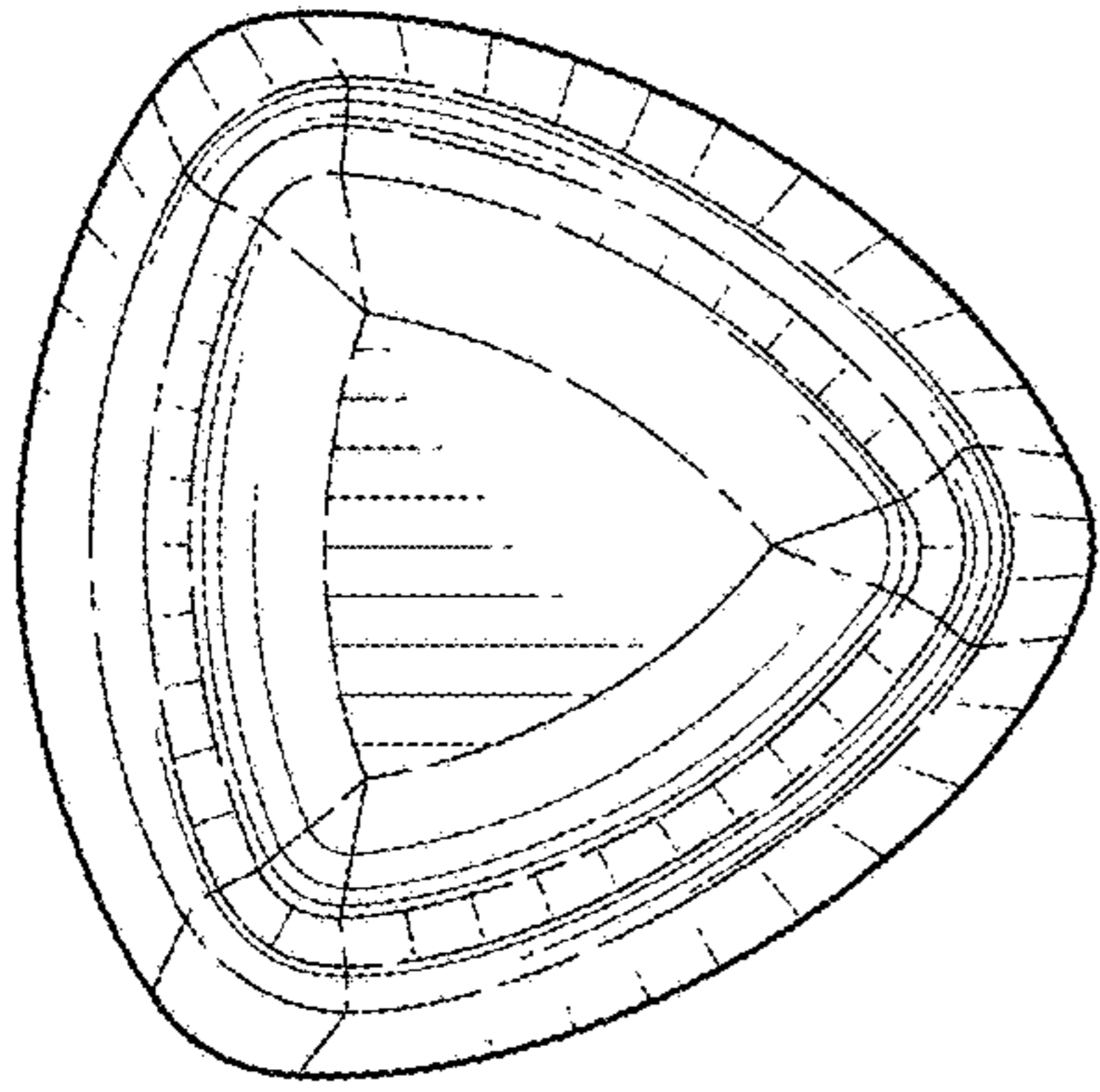

FIG. 17

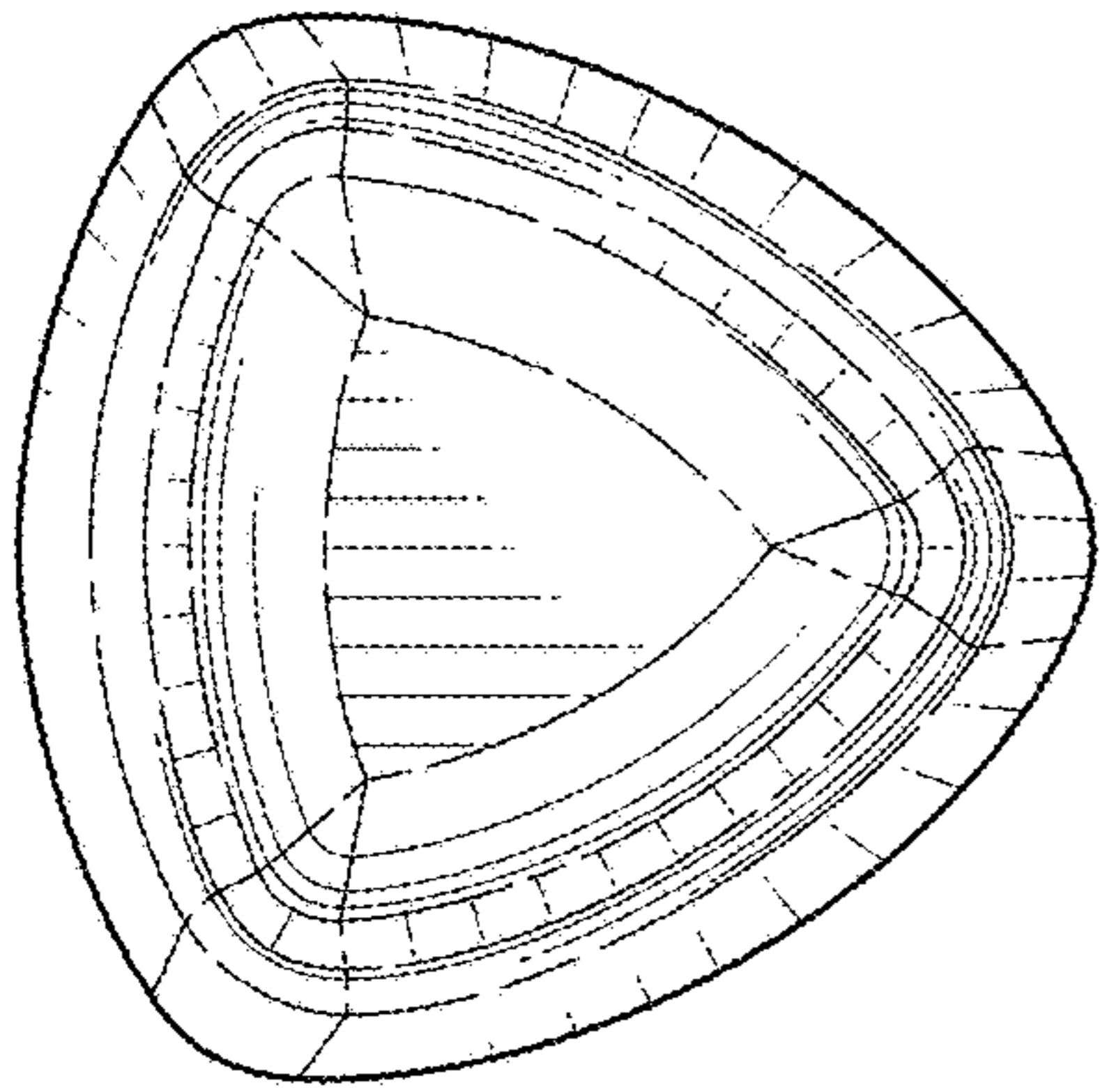

FIG. 18

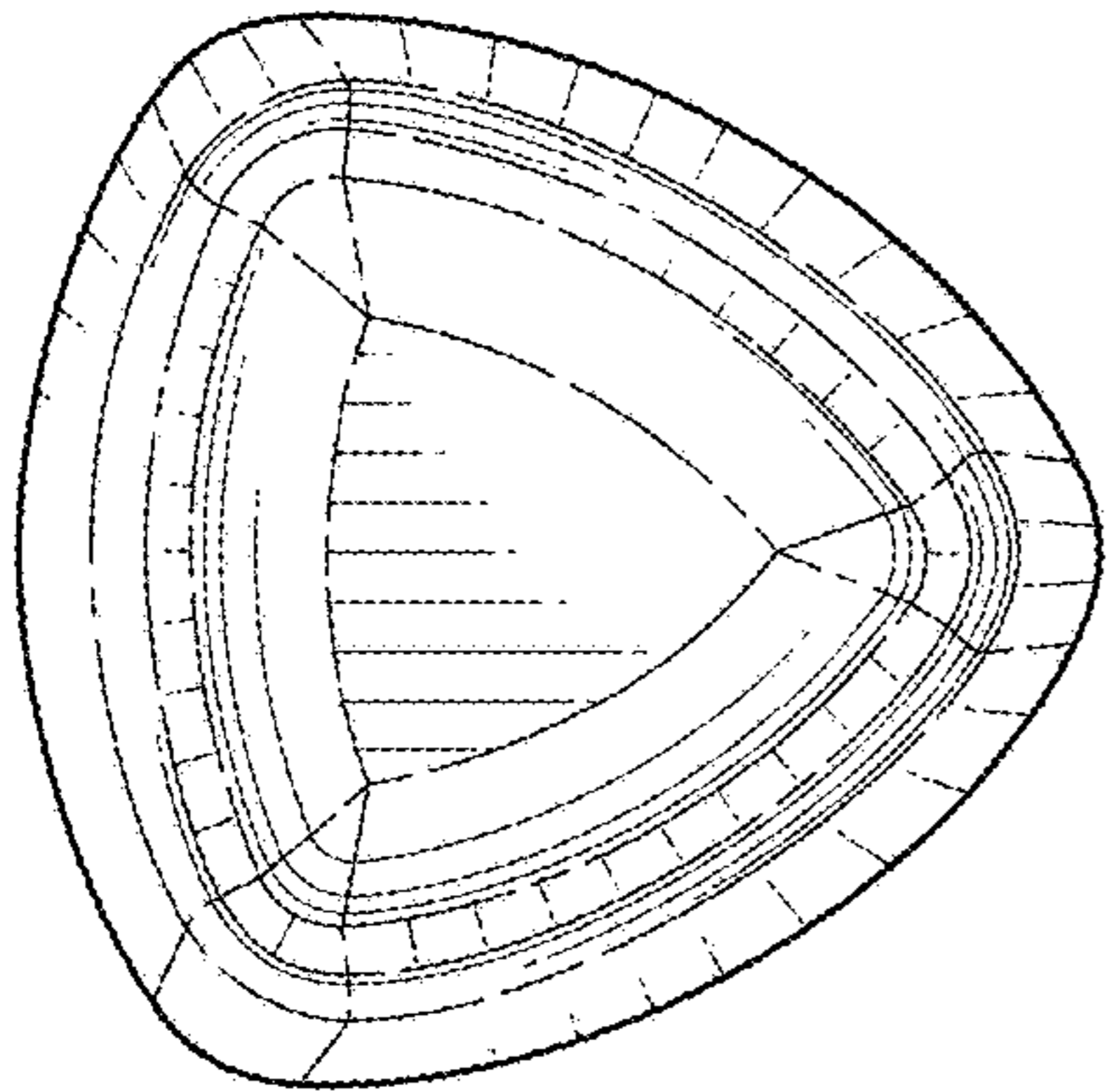

FIG. 19

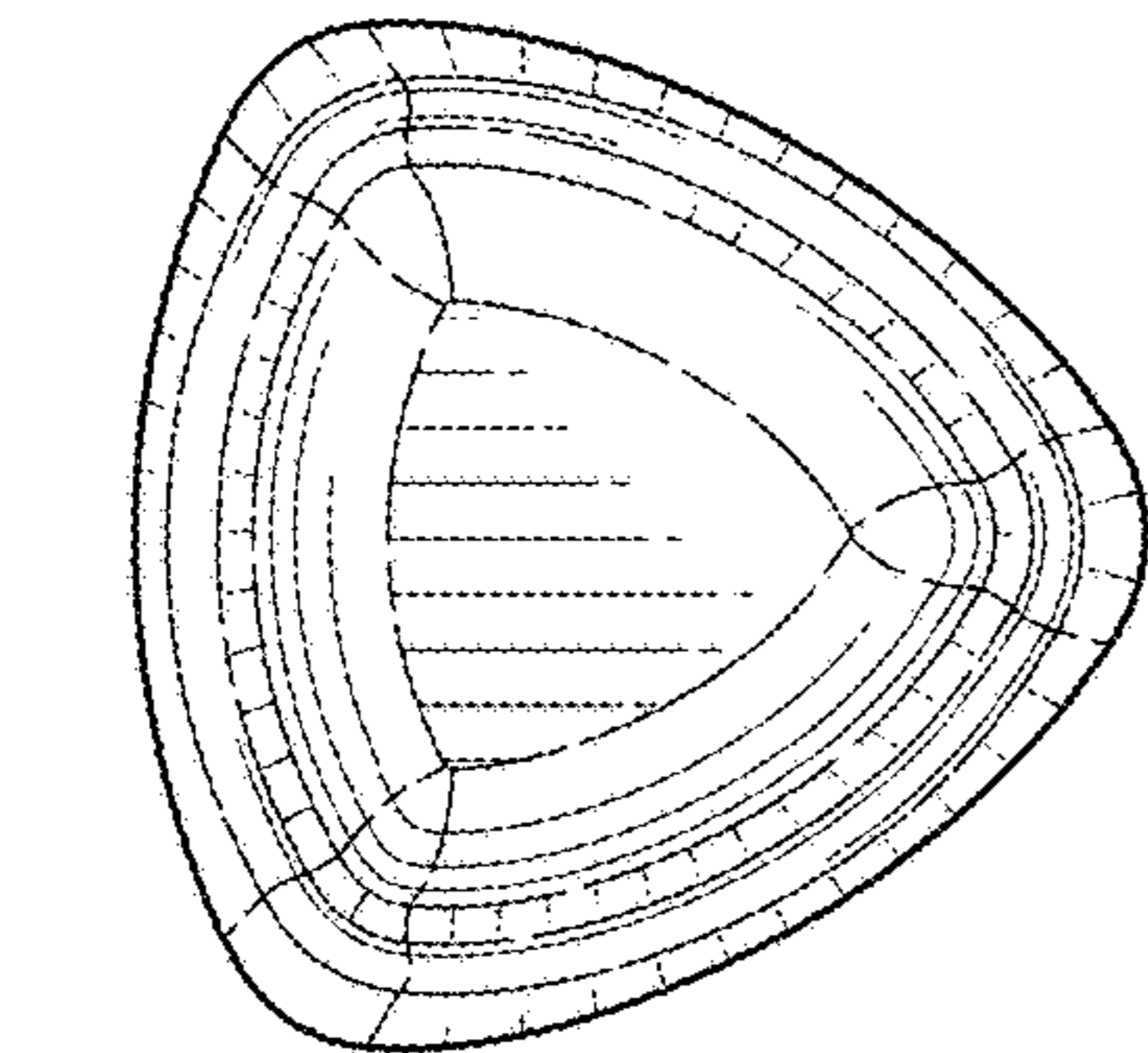

FIG. 20

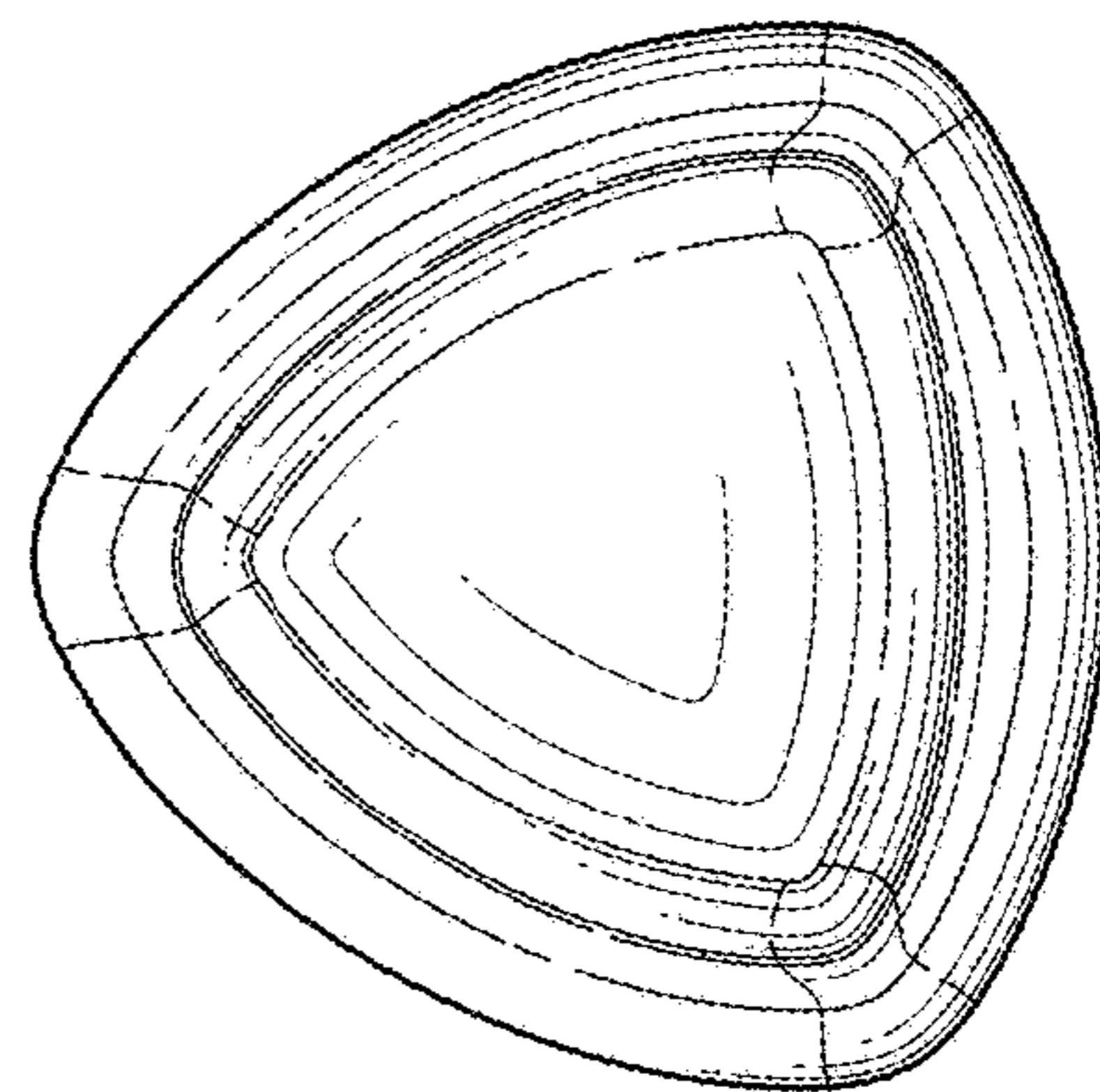

FIG. 21

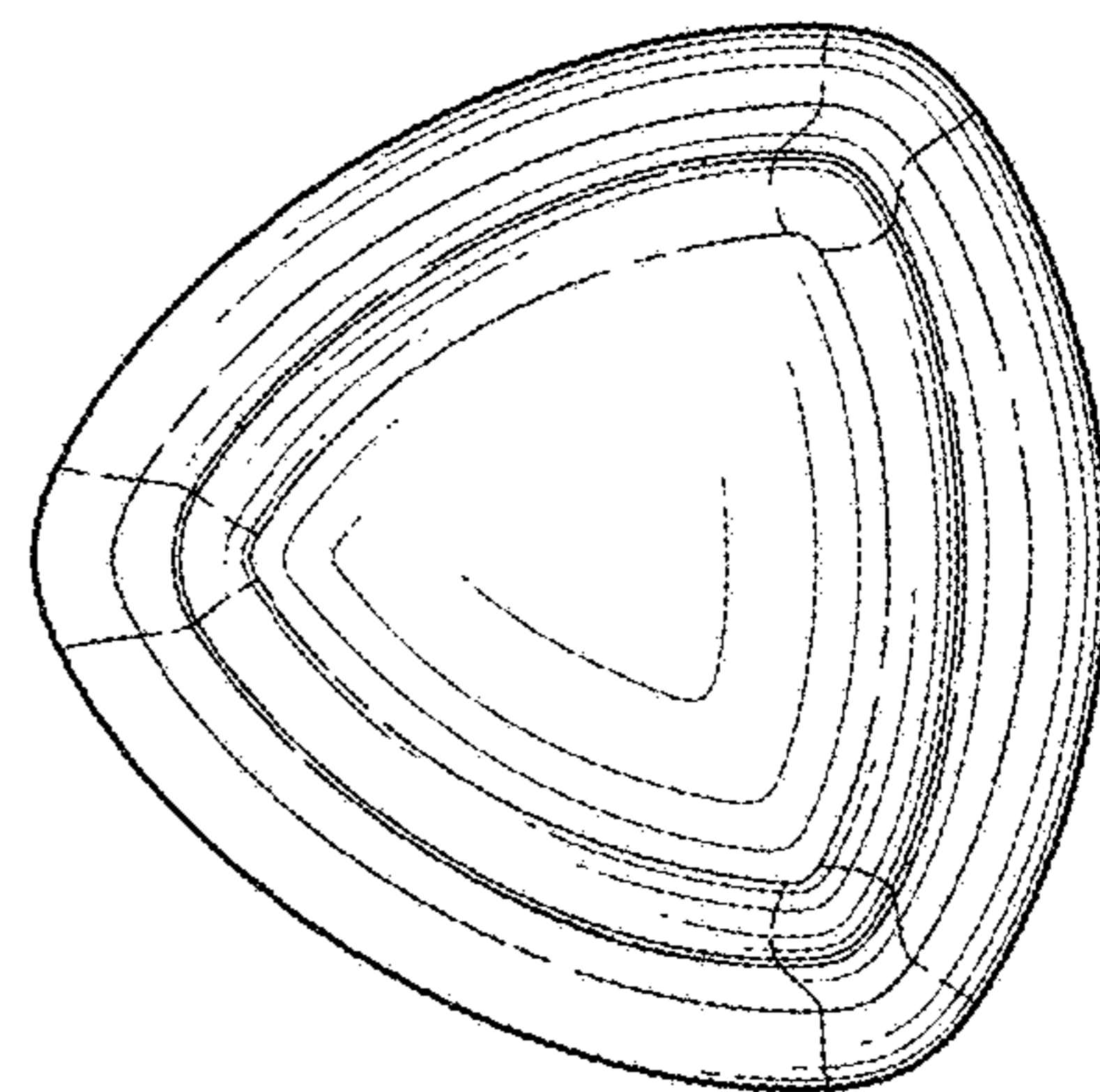

FIG. 22

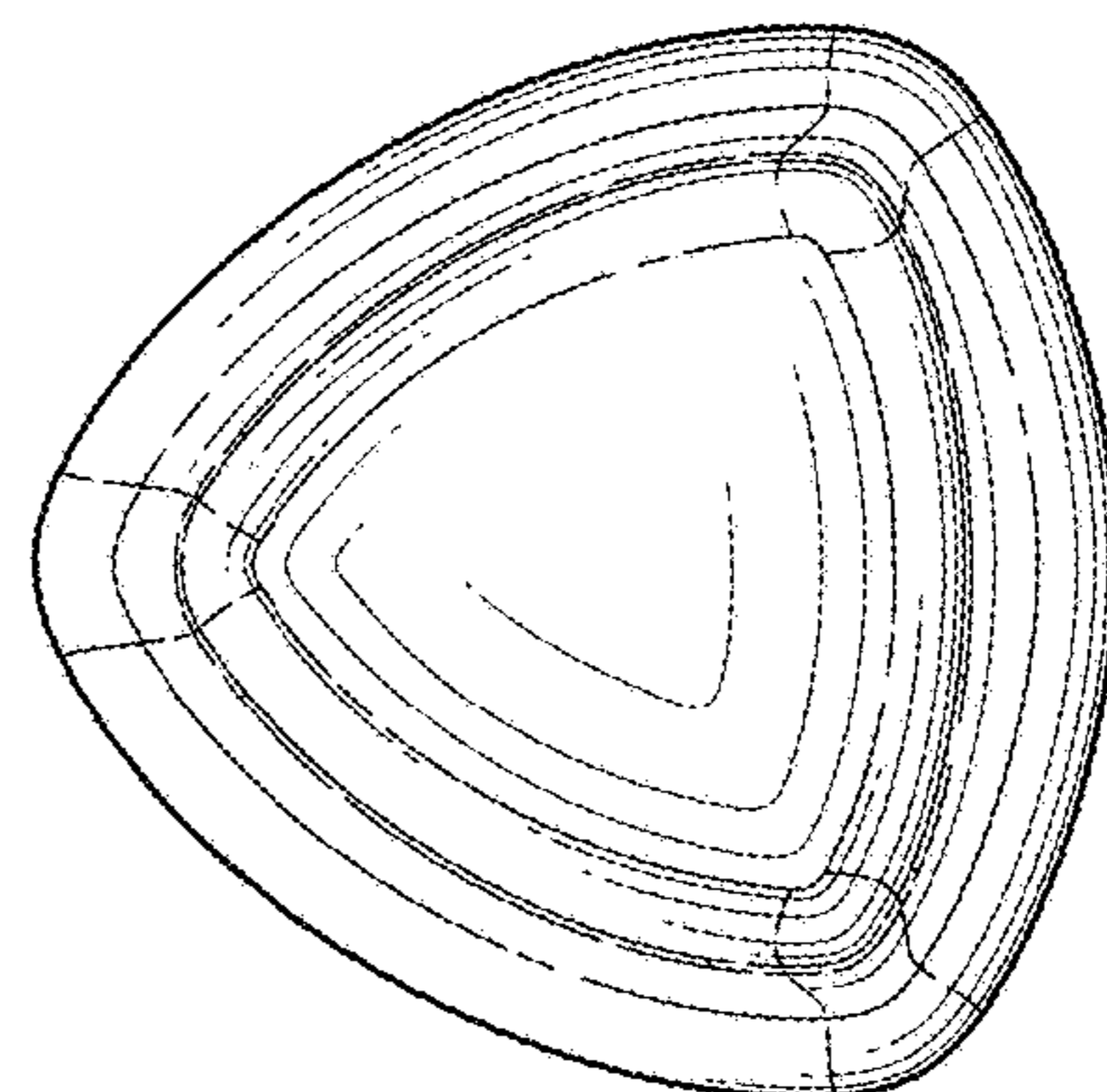

FIG. 23

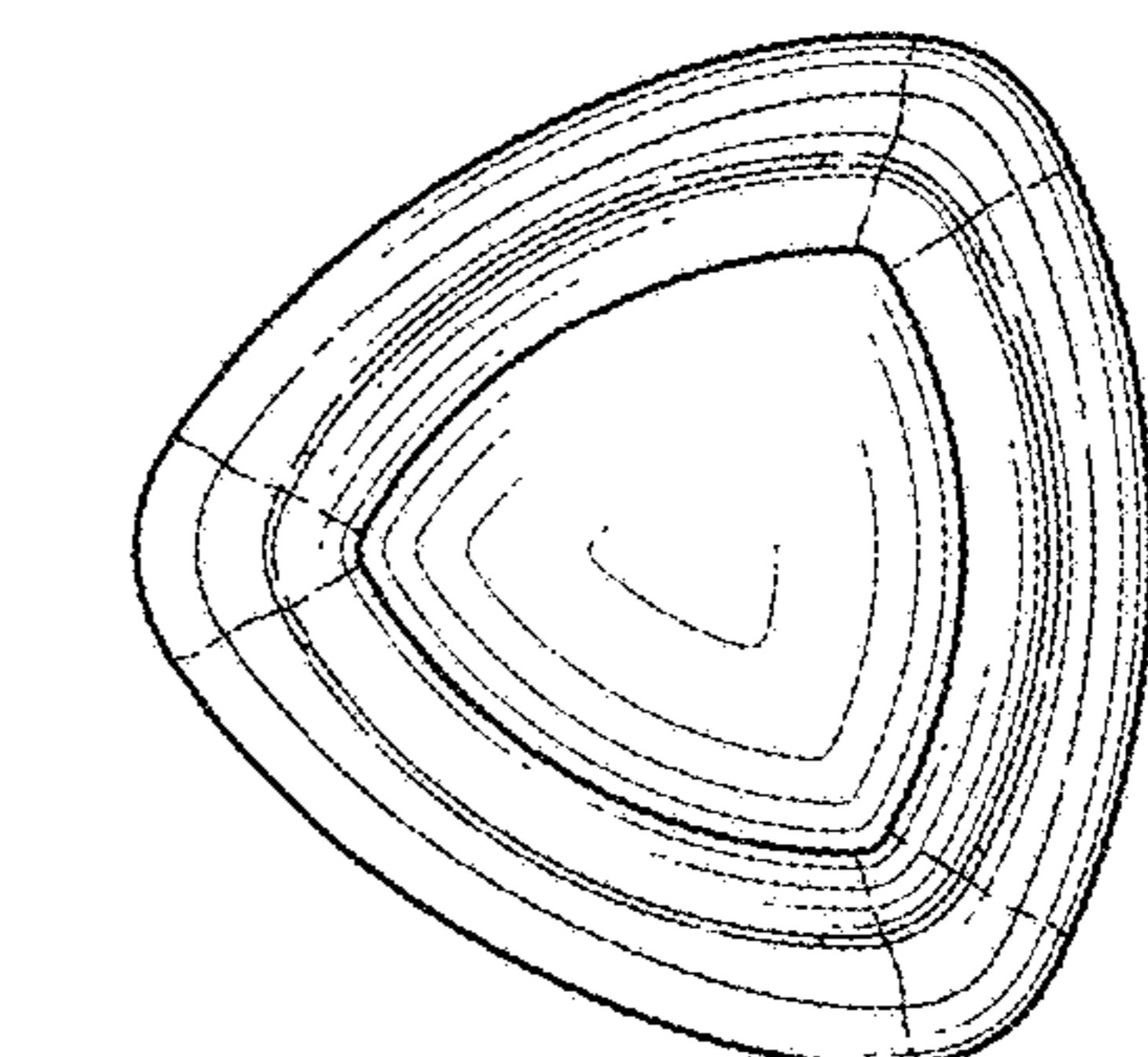

FIG. 24

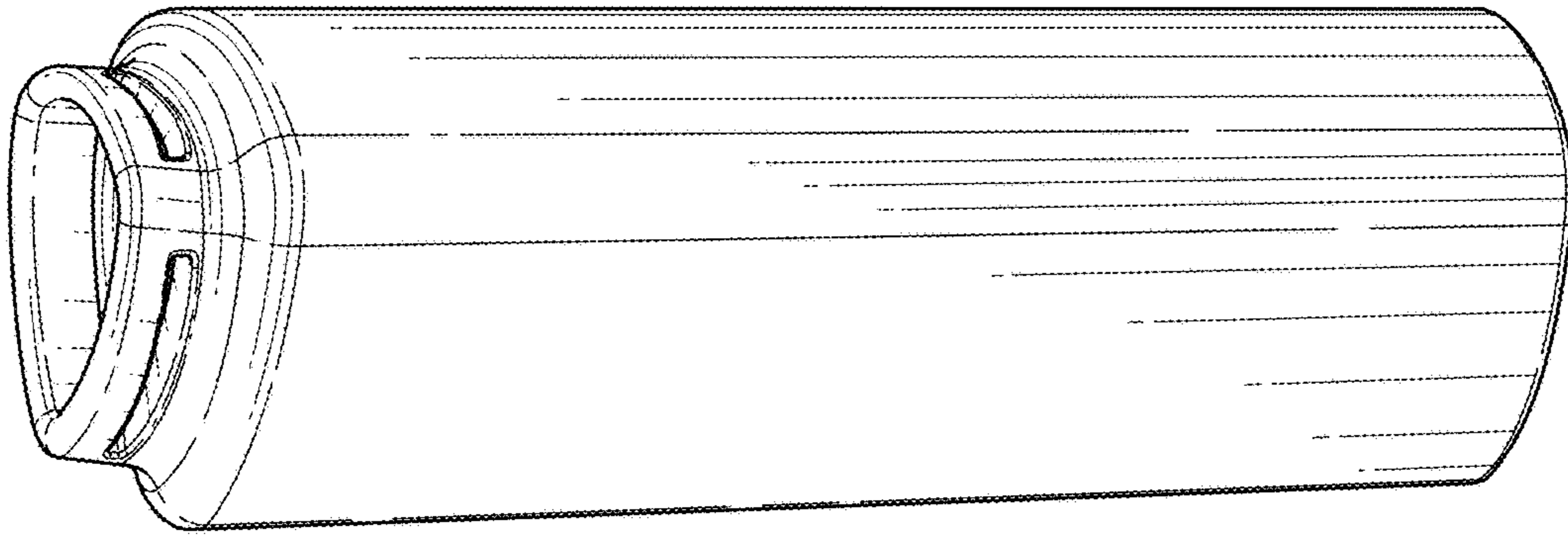

FIG. 28

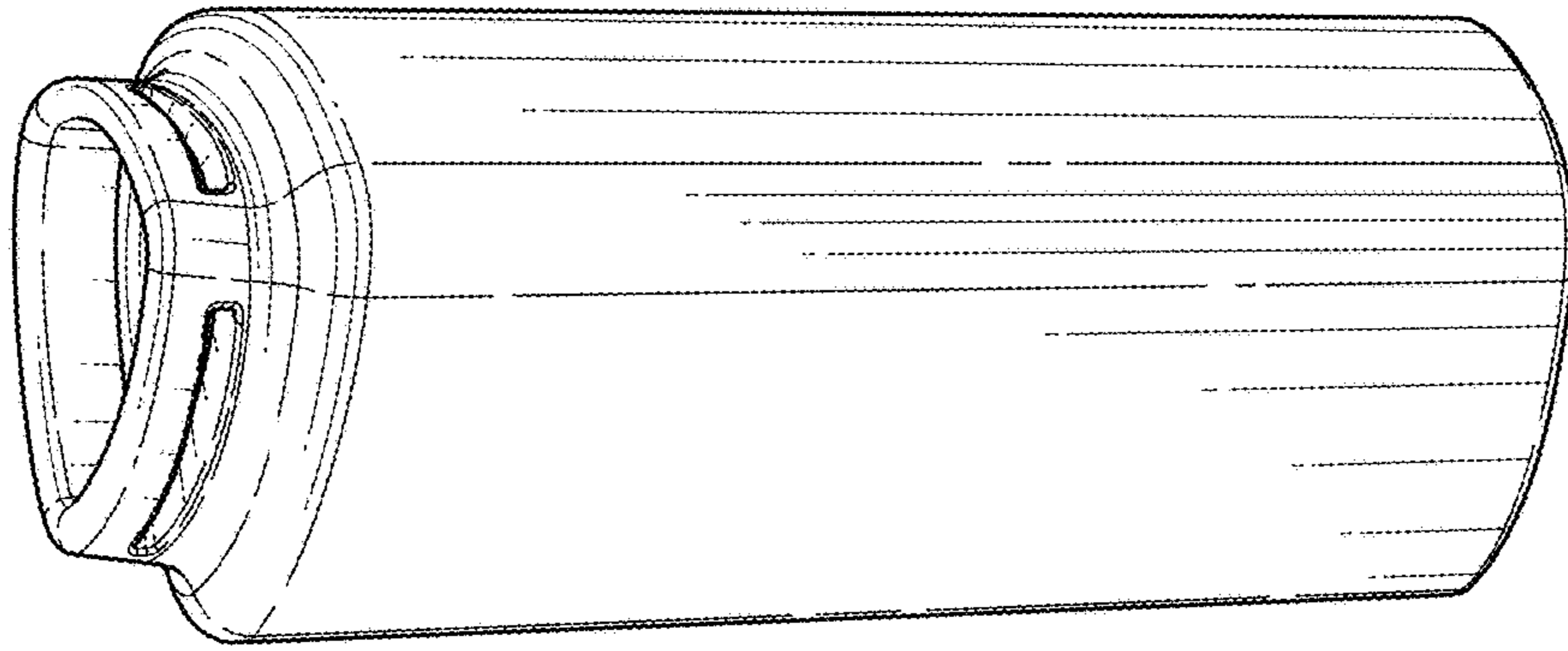

FIG. 27

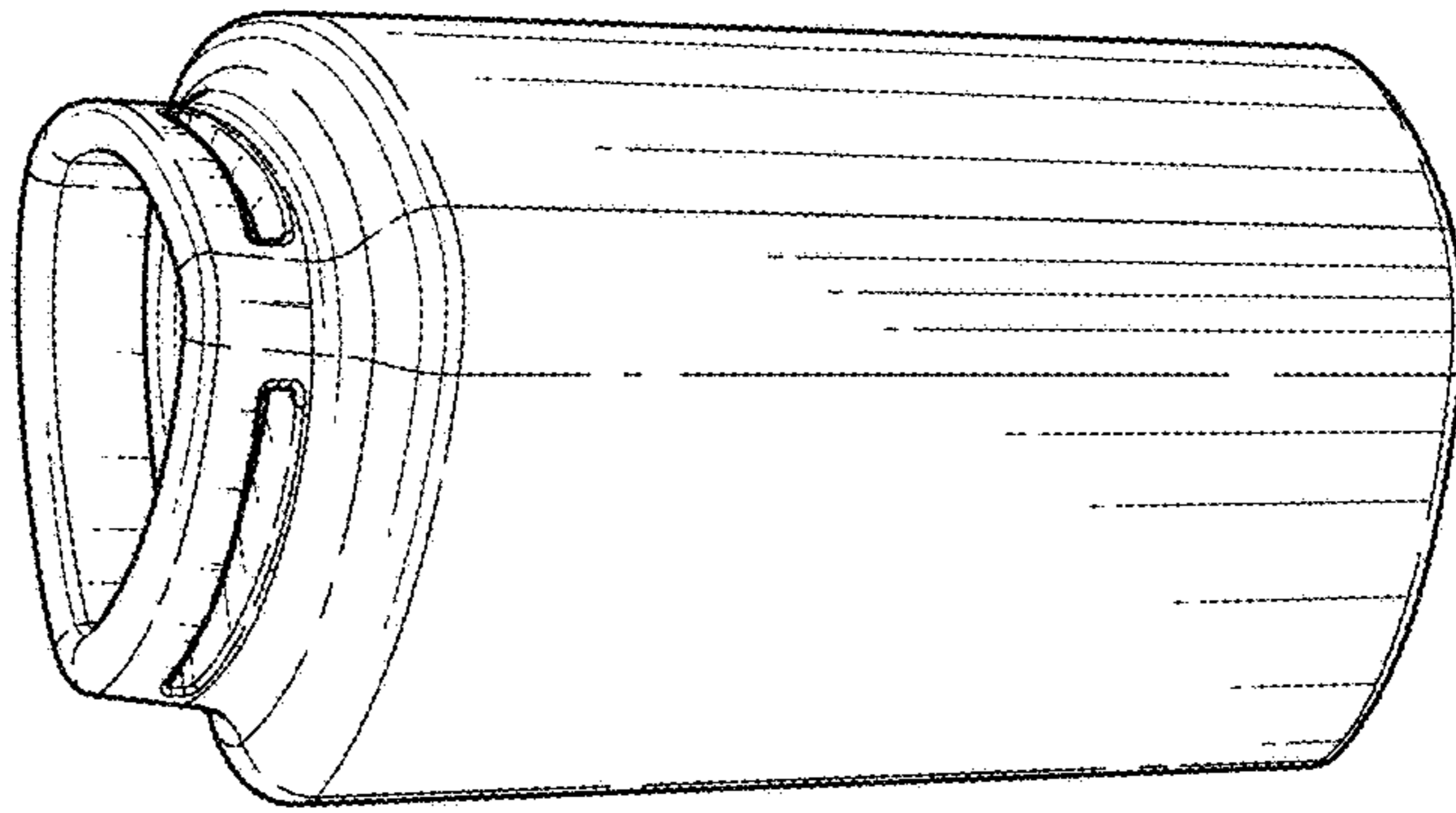

FIG. 26

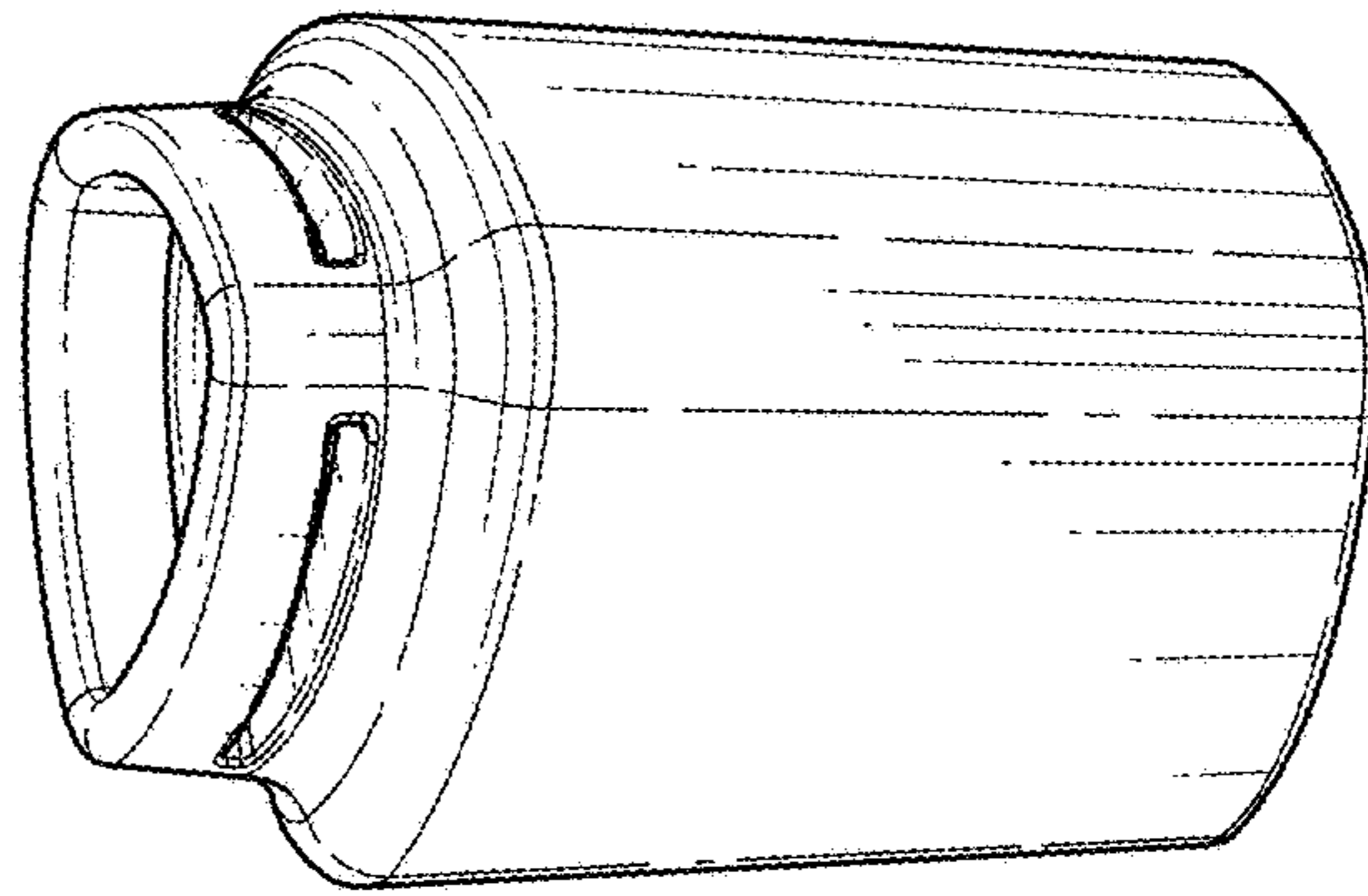

FIG. 25