



US00D812393S

(12) **United States Design Patent**
Karschnik et al.

(10) **Patent No.:** **US D812,393 S**
(45) **Date of Patent:** **** Mar. 13, 2018**

- (54) **BED**
- (71) Applicant: **Select Comfort Corporation**,
Minneapolis, MN (US)
- (72) Inventors: **Kody Lee Karschnik**, Maple Grove,
MN (US); **Craig Peterson**, Oak Grove,
MN (US); **Emily Murphey**,
Washington, DC (US)
- (73) Assignee: **Sleep Number Corporation**,
Minneapolis, MN (US)

- 4,890,344 A 1/1990 Walker
- 4,897,890 A 2/1990 Walker
- 4,908,895 A 3/1990 Walker
- D313,973 S 1/1991 Walker
- 4,991,244 A 2/1991 Walker
- (Continued)

(**) Term: **15 Years**

(21) Appl. No.: **29/577,797**

(22) Filed: **Sep. 15, 2016**

(51) **LOC (11) Cl.** **06-02**

(52) **U.S. Cl.**
USPC **D6/382**

(58) **Field of Classification Search**
USPC D6/382-384, 393, 718, 709, 605, 606
CPC A47C 19/00; A47C 19/021; A47C 19/024;
A47C 19/12; A47C 19/122; A47C 23/00;
A47C 23/005

See application file for complete search history.

(56) **References Cited**

U.S. PATENT DOCUMENTS

D165,074 S *	11/1951	Herrmann	D6/394
D202,776 S *	11/1965	Pearsall	297/411.44
4,106,138 A *	8/1978	Murphy	A47C 19/021
				5/181
D255,402 S	6/1980	Lundgren		
4,394,784 A *	7/1983	Swenson	A47C 27/082
				415/121.3
D271,729 S	12/1983	Dodrill		
4,766,628 A	8/1988	Greer et al.		
4,788,729 A	12/1988	Greer et al.		
D300,194 S	3/1989	Walker		
4,829,616 A	5/1989	Walker		

OTHER PUBLICATIONS

FreshBed, "What is a FreshBed?" YouTube video, Oct. 10, 2014, site visited Sep. 21, 2017, available online at <https://www.youtube.com/watch?v=p4hxNni3M1U> (Year: 2014).*

(Continued)

Primary Examiner — Cathron C Brooks

(74) *Attorney, Agent, or Firm* — Fish & Richardson P.C.

(57) **CLAIM**

The ornamental design for a bed, as shown and described.

DESCRIPTION

FIG. 1 is a top perspective view of a bed according to a first embodiment.

FIG. 2 is a front view of the bed of FIG. 1.

FIG. 3 is a back view of the bed of FIG. 1.

FIG. 4 is a left side view of the bed of FIG. 1.

FIG. 5 is a right side view of the bed of FIG. 1.

FIG. 6 is a top view of the bed of FIG. 1.

FIG. 7 is a bottom view of the bed of FIG. 1.

FIG. 8 is a top perspective view of a bed according to a second embodiment.

FIG. 9 is a front view of the bed of FIG. 8.

FIG. 10 is a back view of the bed of FIG. 8.

FIG. 11 is a left side view of the bed of FIG. 8.

FIG. 12 is a right side view of the bed of FIG. 8.

FIG. 13 is a top view of the bed of FIG. 8; and,

FIG. 14 is a bottom view of the bed of FIG. 8.

The broken lines in the drawings illustrate portions of the bed that form no part of the claimed design.

1 Claim, 10 Drawing Sheets

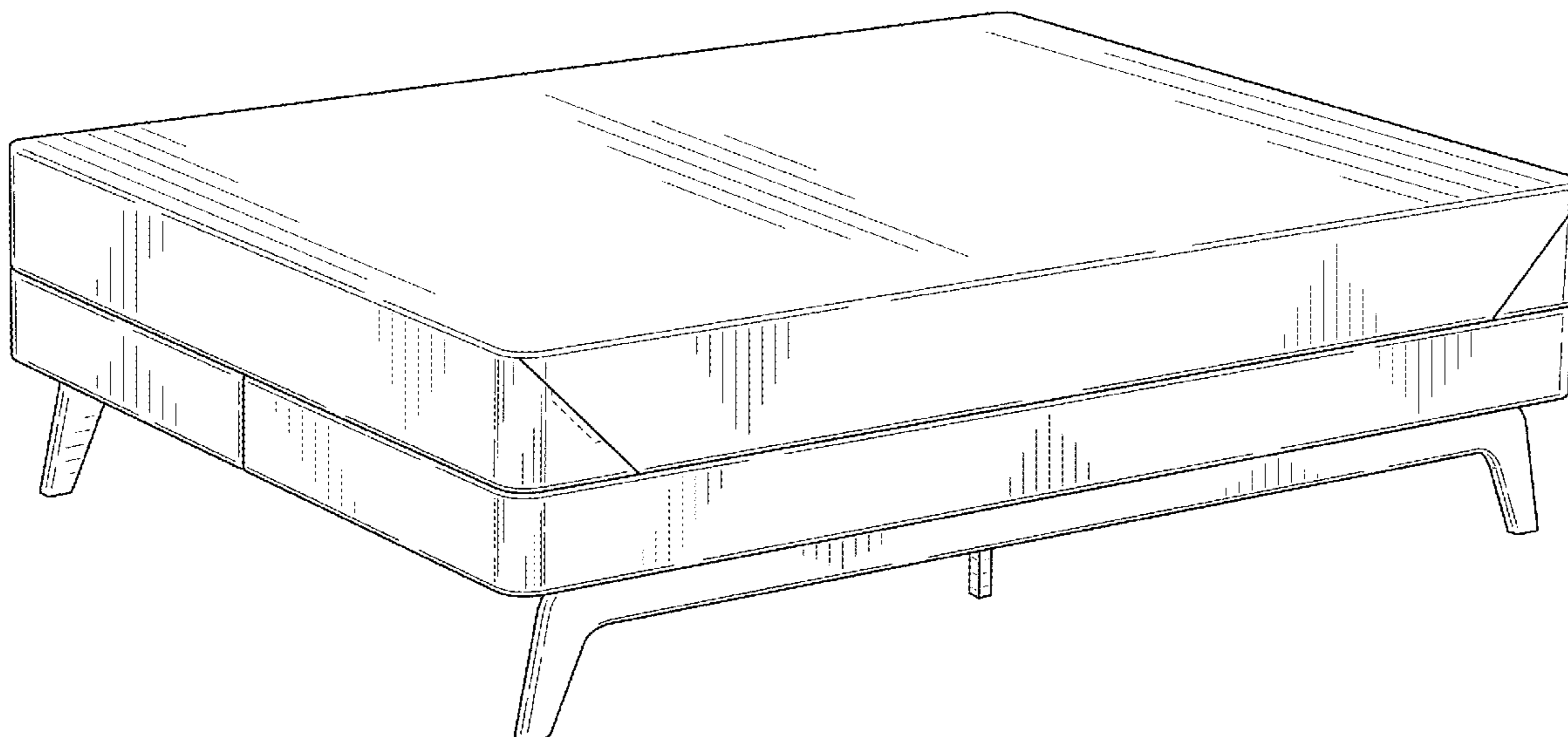

(56)

References Cited

U.S. PATENT DOCUMENTS

5,144,706 A 9/1992 Walker et al.
D331,159 S 11/1992 Bueno
5,170,522 A * 12/1992 Walker A47C 20/048
5/615
5,173,976 A * 12/1992 Jubinville A47G 9/0246
5/497
5,477,571 A 12/1995 Roggenkamp et al.
D368,475 S 4/1996 Scott
5,509,154 A 4/1996 Shafer et al.
D370,794 S 6/1996 Mann et al.
5,564,140 A 10/1996 Shoenhair et al.
5,642,546 A 7/1997 Shoenhair
5,652,484 A 7/1997 Shafer et al.
D393,378 S * 4/1998 Hutton D6/382
5,765,246 A 6/1998 Shoenhair
5,903,941 A 5/1999 Shafer et al.
5,904,172 A 5/1999 Giff et al.
6,035,468 A 3/2000 Lee
6,037,723 A 3/2000 Shafer et al.
6,108,844 A 8/2000 Kraft et al.
6,161,231 A 12/2000 Kraft et al.
6,202,239 B1 3/2001 Ward et al.
6,256,821 B1 7/2001 Boyd
6,397,419 B1 6/2002 Mechache
6,483,264 B1 11/2002 Shafer et al.
6,686,711 B2 2/2004 Rose et al.
6,708,357 B2 * 3/2004 Gaboury A47C 23/007
5/663
6,763,541 B2 7/2004 Mahoney et al.
6,804,848 B1 10/2004 Rose
6,832,397 B2 12/2004 Gaboury
D502,929 S 3/2005 Copeland et al.
6,883,191 B2 4/2005 Gaboury et al.
D509,677 S * 9/2005 Junbeau D6/393
7,191,483 B2 * 3/2007 Hochschild A47C 27/001
5/691
7,231,676 B2 6/2007 Cloer et al.
D551,011 S 9/2007 Van Patten
7,389,554 B1 6/2008 Rose
7,640,611 B1 1/2010 Kluff
7,865,988 B2 1/2011 Koughan et al.
D644,851 S * 9/2011 Colombo D6/393
D646,908 S * 10/2011 Szekely D6/382
D653,870 S 2/2012 Messenger
D657,158 S 4/2012 McCarty et al.
D666,448 S * 9/2012 Morrison D6/597
D667,671 S 9/2012 Rinehart
D669,726 S * 10/2012 Wightman D6/605
8,282,452 B2 10/2012 Grigsby et al.
8,336,369 B2 12/2012 Mahoney
8,444,558 B2 5/2013 Young et al.
D691,118 S 10/2013 Ingham et al.
D697,874 S 1/2014 Stusynski et al.
D698,338 S 1/2014 Ingham
D701,536 S 3/2014 Sakal

8,672,853 B2 3/2014 Young
D707,463 S 6/2014 McCarty et al.
8,769,747 B2 7/2014 Mahoney et al.
D717,088 S 11/2014 Rawls-Meehan
D717,561 S * 11/2014 Wurst D6/382
D717,575 S 11/2014 Rawls-Meehan
8,931,329 B2 1/2015 Mahoney et al.
8,966,689 B2 3/2015 McGuire et al.
8,973,183 B1 3/2015 Palashewski et al.
8,984,687 B2 3/2015 Stusynski et al.
D732,852 S * 6/2015 Park D6/656
D737,250 S 8/2015 Ingham et al.
D782,221 S * 3/2017 Wightman D6/605
D789,128 S * 6/2017 Hurford D6/709
2003/0079284 A1 5/2003 Gaboury et al.
2008/0077020 A1 3/2008 Young et al.
2011/0144455 A1 6/2011 Young et al.
2014/0182061 A1 7/2014 Zaiss
2014/0250597 A1 9/2014 Chen et al.
2014/0257571 A1 9/2014 Chen et al.
2014/0259417 A1 9/2014 Nunn et al.
2014/0259418 A1 9/2014 Nunn et al.
2014/0259431 A1 9/2014 Fleury
2014/0259433 A1 9/2014 Nunn et al.
2014/0259434 A1 9/2014 Nunn et al.
2014/0277611 A1 9/2014 Nunn et al.
2014/0277778 A1 9/2014 Nunn et al.
2014/0277822 A1 9/2014 Nunn et al.
2015/0007393 A1 1/2015 Palashewski
2015/0025327 A1 1/2015 Young et al.
2015/0026896 A1 1/2015 Fleury et al.
2015/0157137 A1 6/2015 Nunn et al.
2015/0157519 A1 6/2015 Stusynski et al.
2015/0182033 A1 7/2015 Brosnan et al.
2015/0182397 A1 7/2015 Palashewski et al.
2015/0182399 A1 7/2015 Palashewski et al.
2015/0182418 A1 7/2015 Zaiss
2015/0290059 A1 10/2015 Brosnan et al.
2015/0366366 A1 12/2015 Zaiss et al.
2015/0374137 A1 12/2015 Mahoney et al.
2016/0100696 A1 4/2016 Palashewski et al.

OTHER PUBLICATIONS

Sculpted Mid-Century Modern Bed Frame, Kent Coffey, Istdibs, Inc., (c) 2017, site visited Sep. 30, 2017, available online at https://www.1stdibs.com/...more-furniture-collectibles/bedroom-furniture/beds-frames/sculpted-mid-century-modern-bed-frame-kent-coffey/id-f_1208682/ (Year: 2017).*

The Bosco Bed, Moderncre8ve, (c) 2015, site visited Sep. 30, 2017, available online at <https://www.custommade.com/the-bosco-midcentury-modern-solid-walnut-bed/by/moderncre8ve/> (Year: 2015).*

The Stowe Bed, Moderncre8ve, (c) 2017, site visited Sep. 30, 2017, available online at <https://moderncre8ve.com/collections/housewares/products/the-stowe> (Year: 2017).*

* cited by examiner

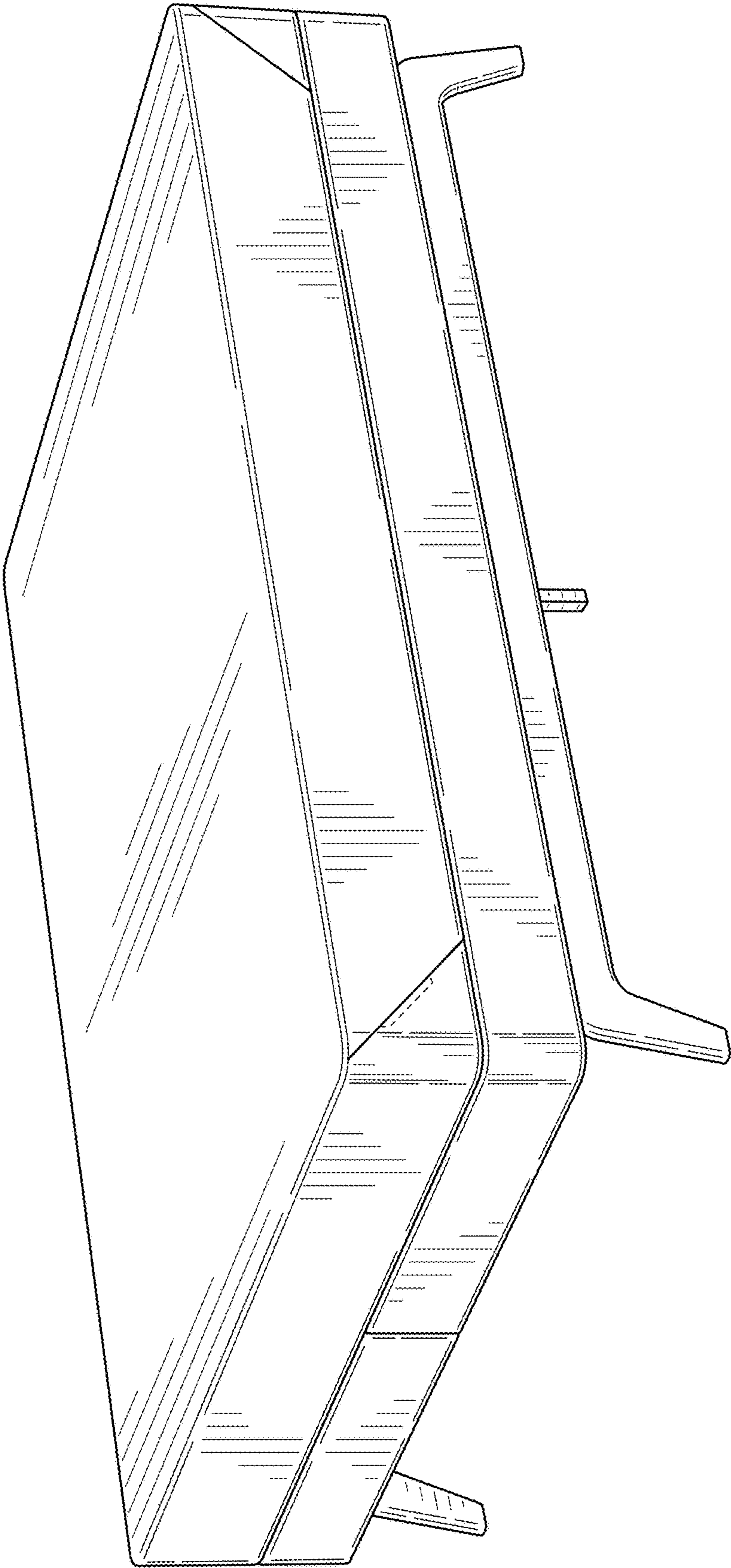

FIG. 1

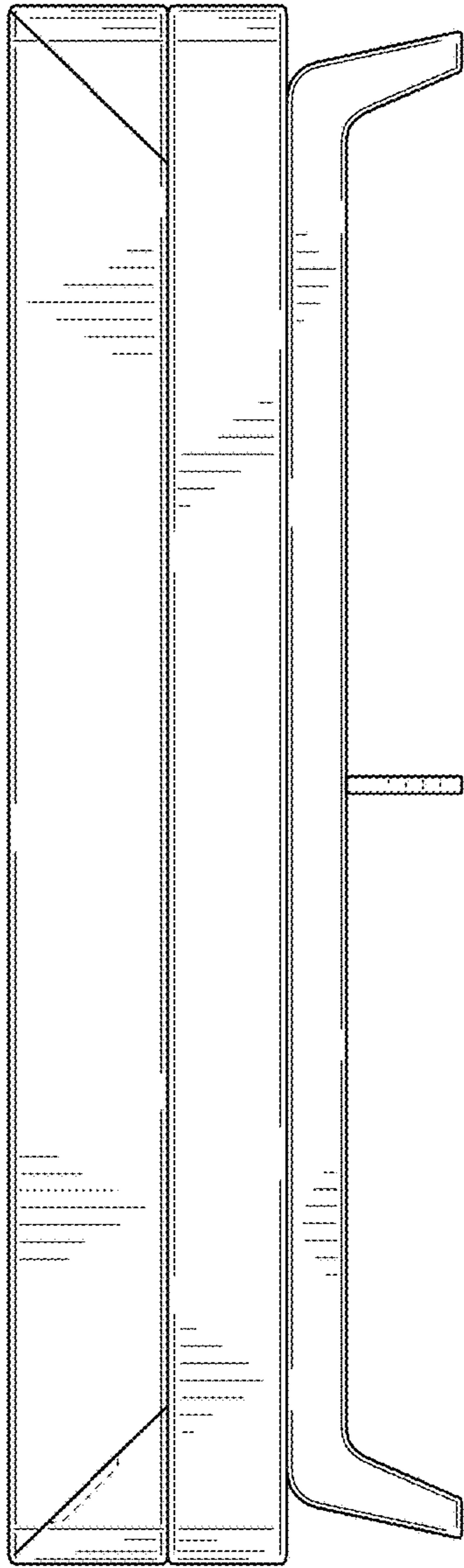

FIG. 2

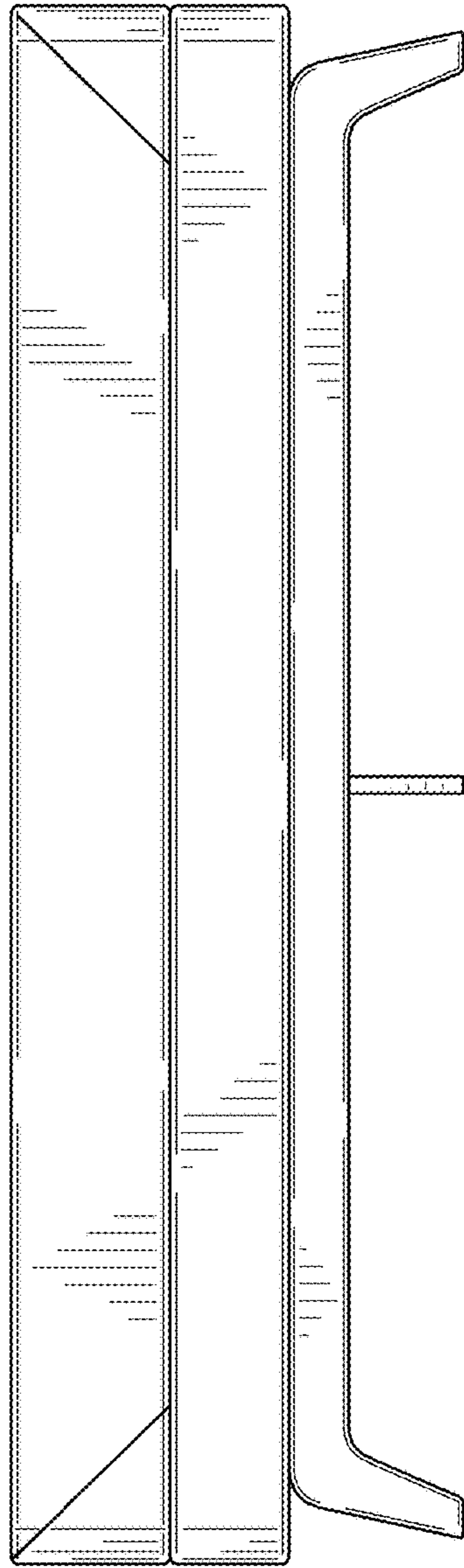

FIG. 3

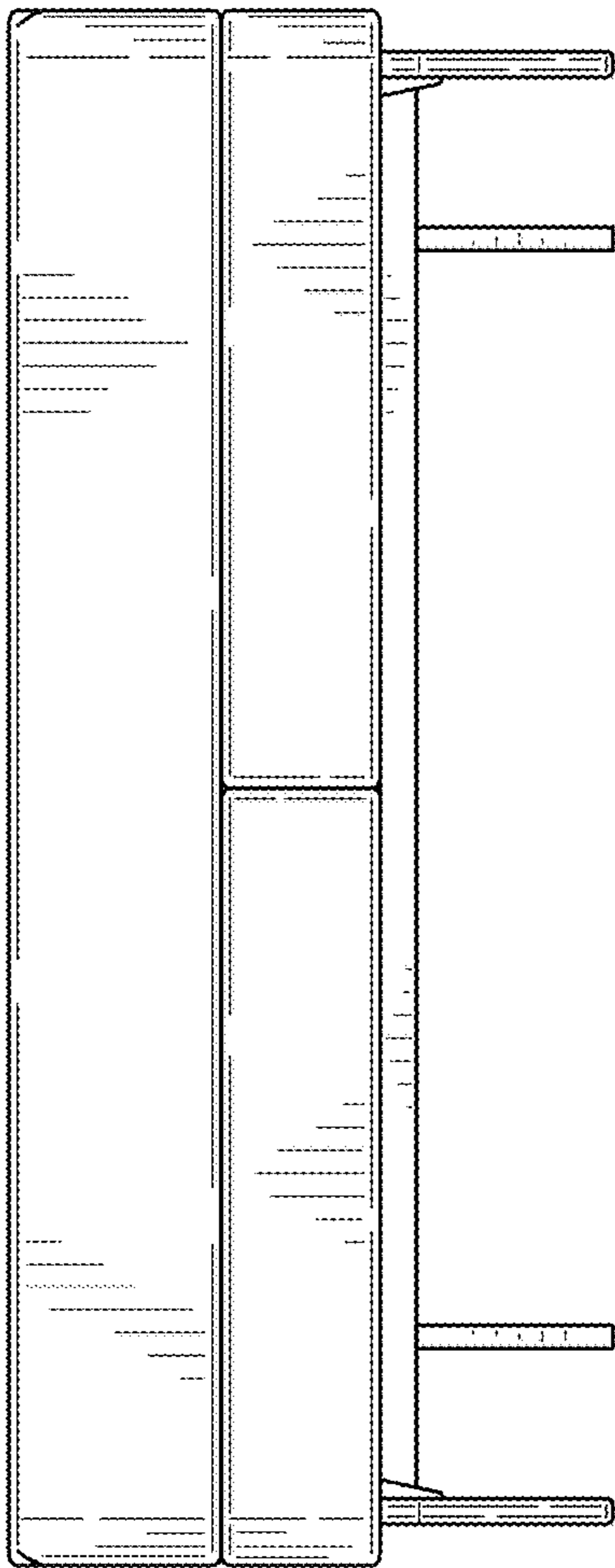

FIG. 4

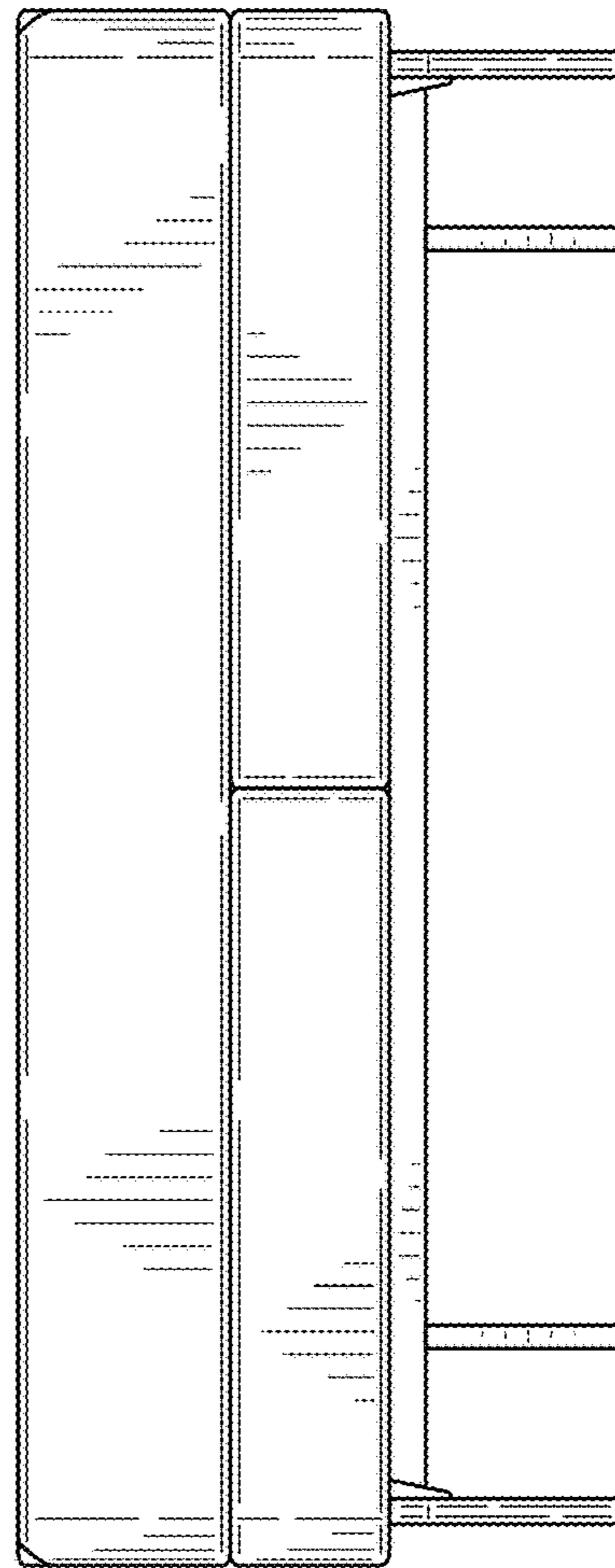

FIG. 5

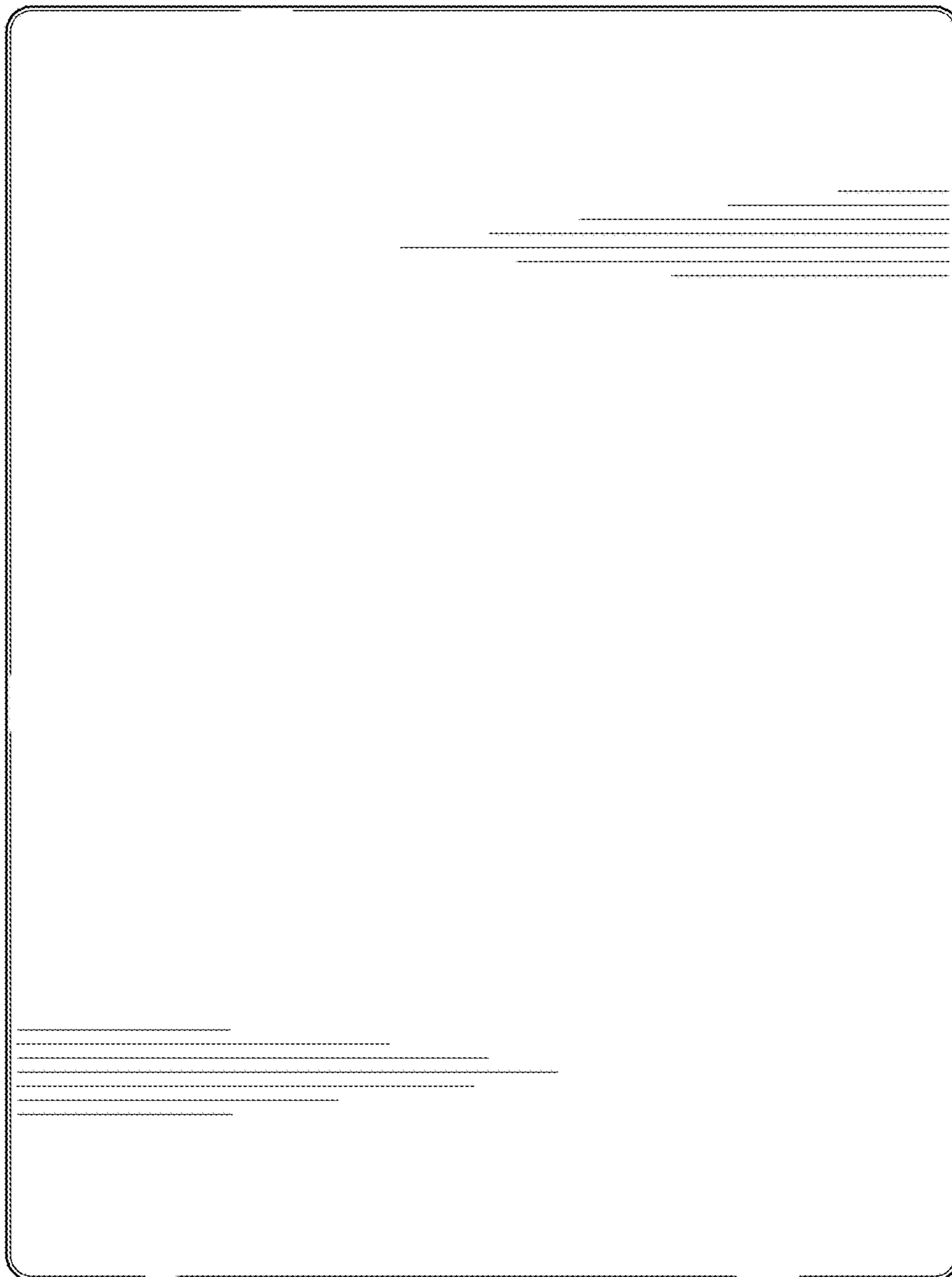

FIG. 6

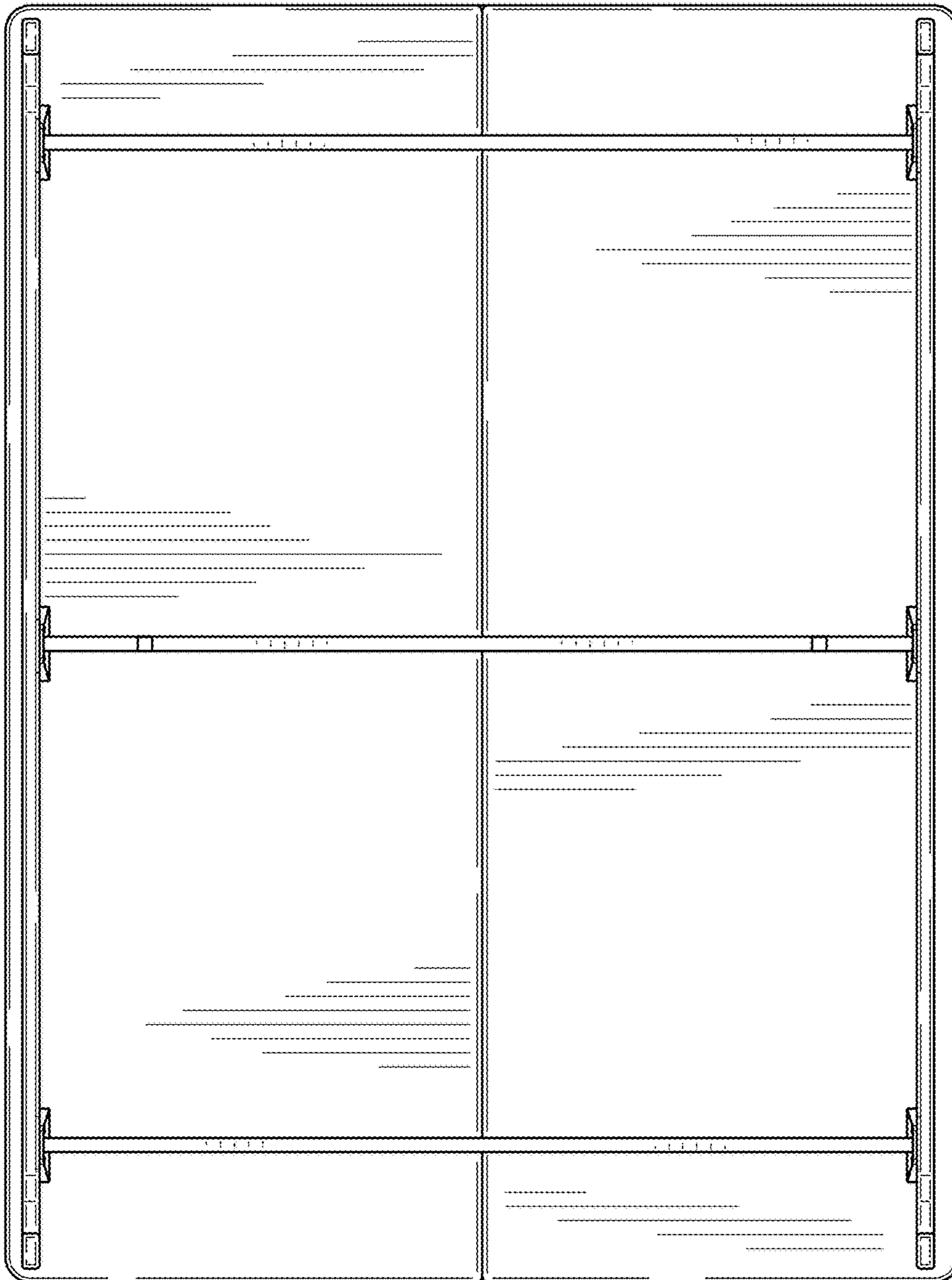

FIG. 7

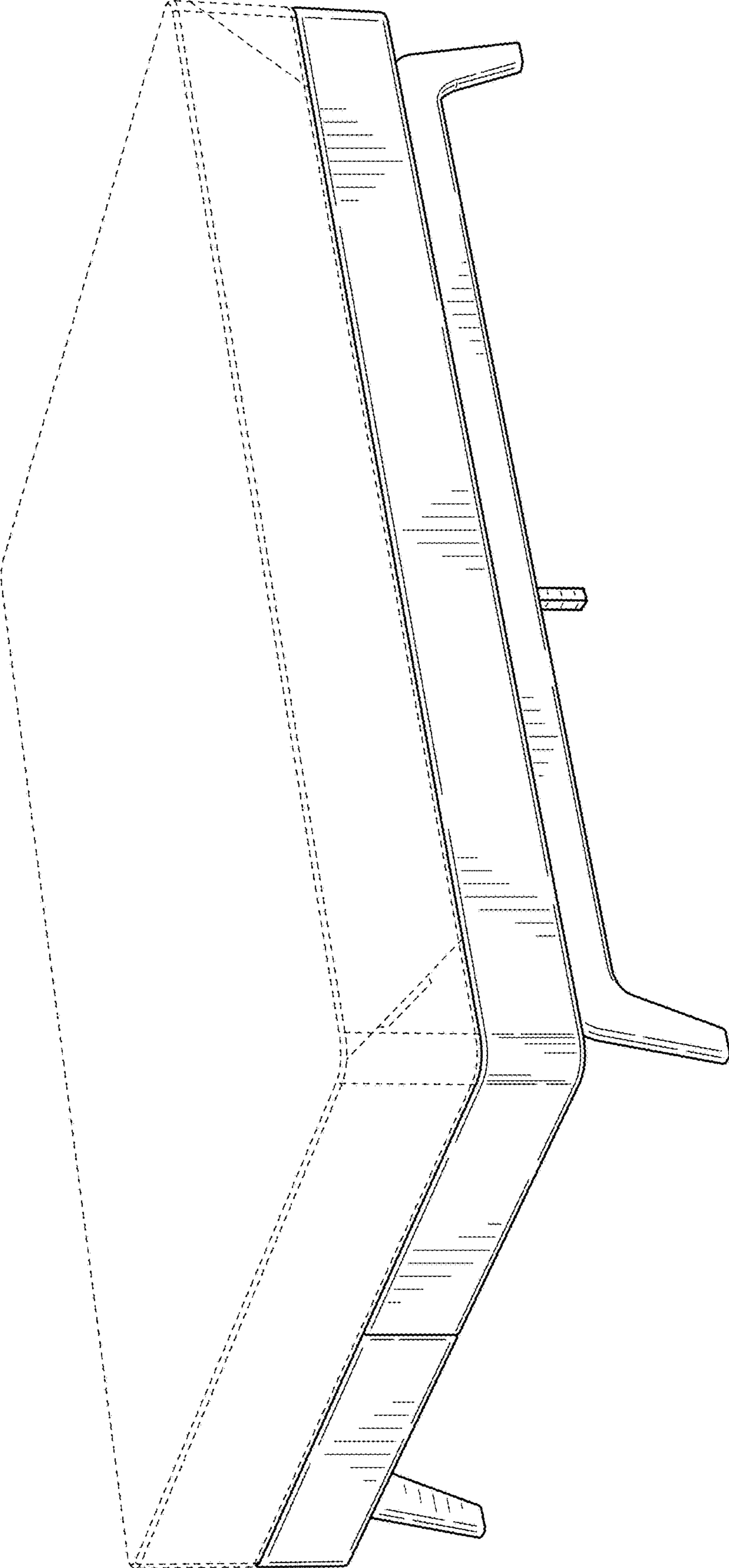

FIG.8

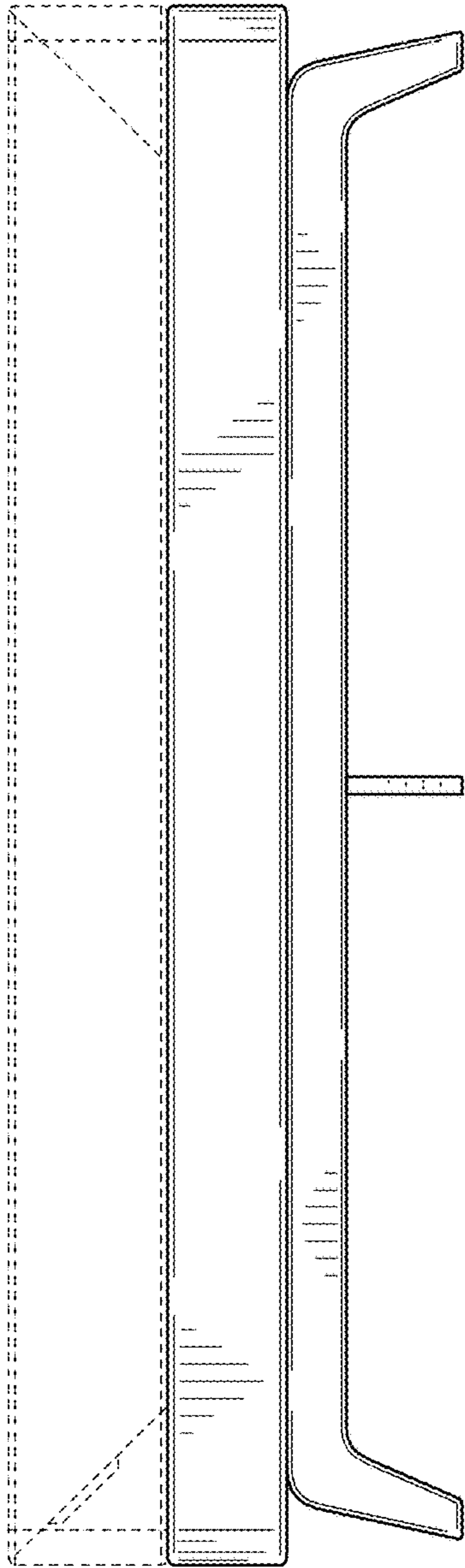

FIG. 9

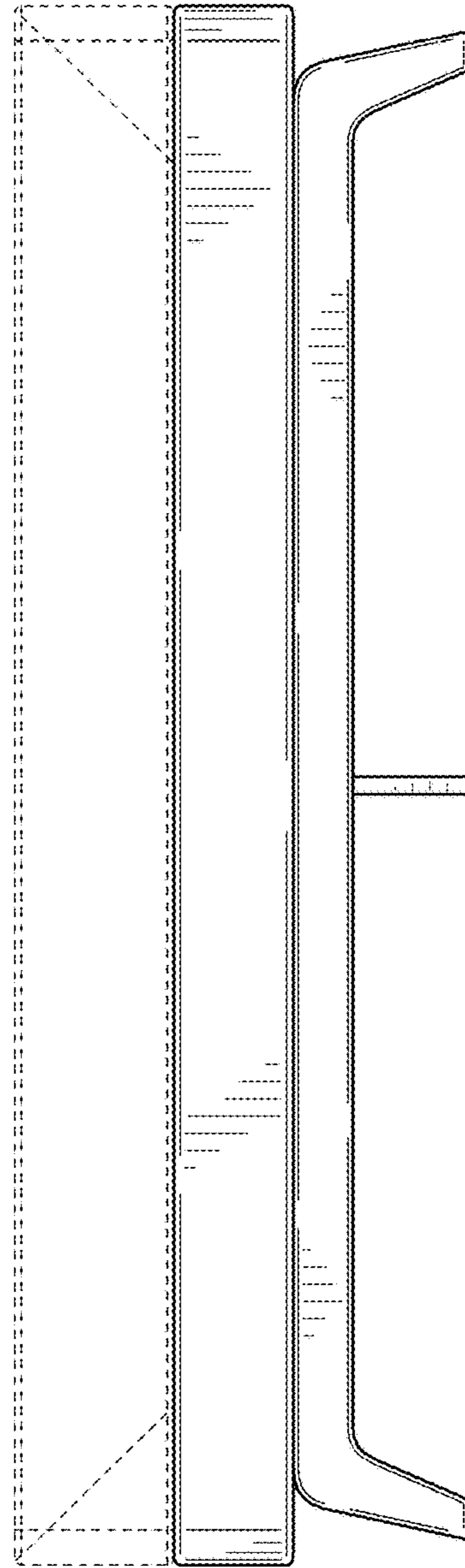

FIG. 10

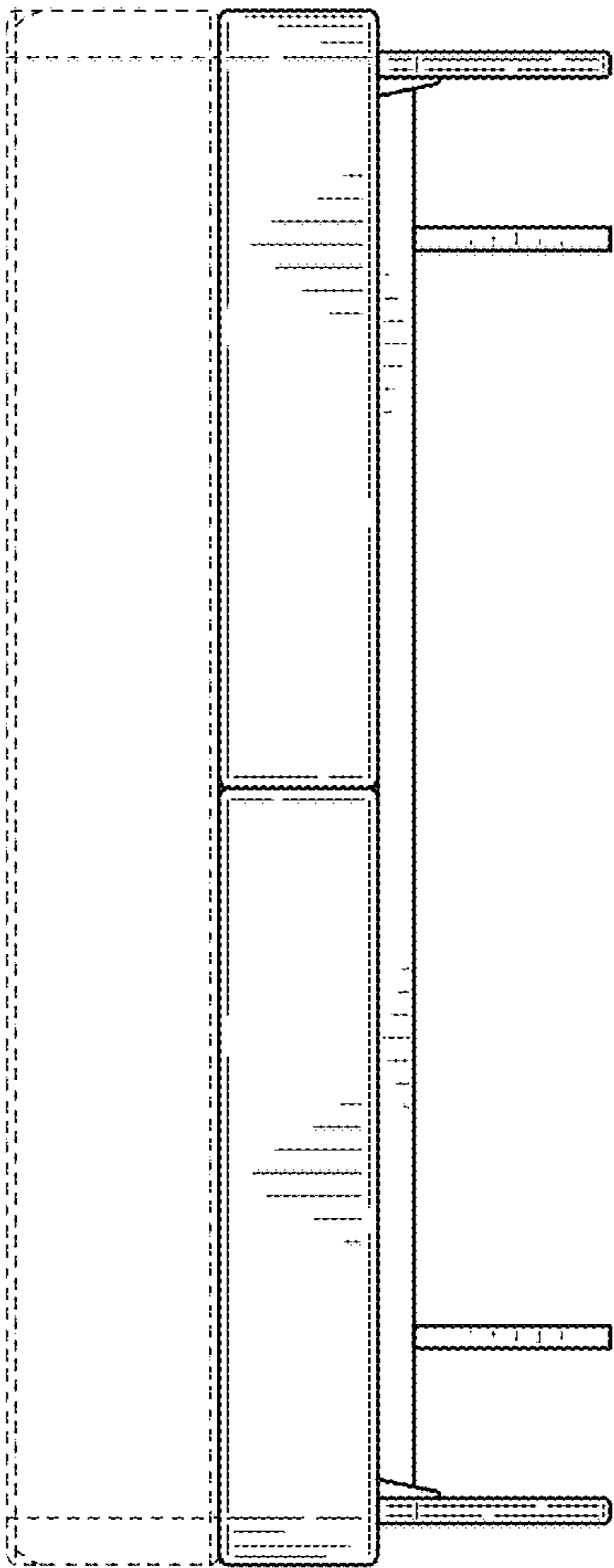

FIG. 11

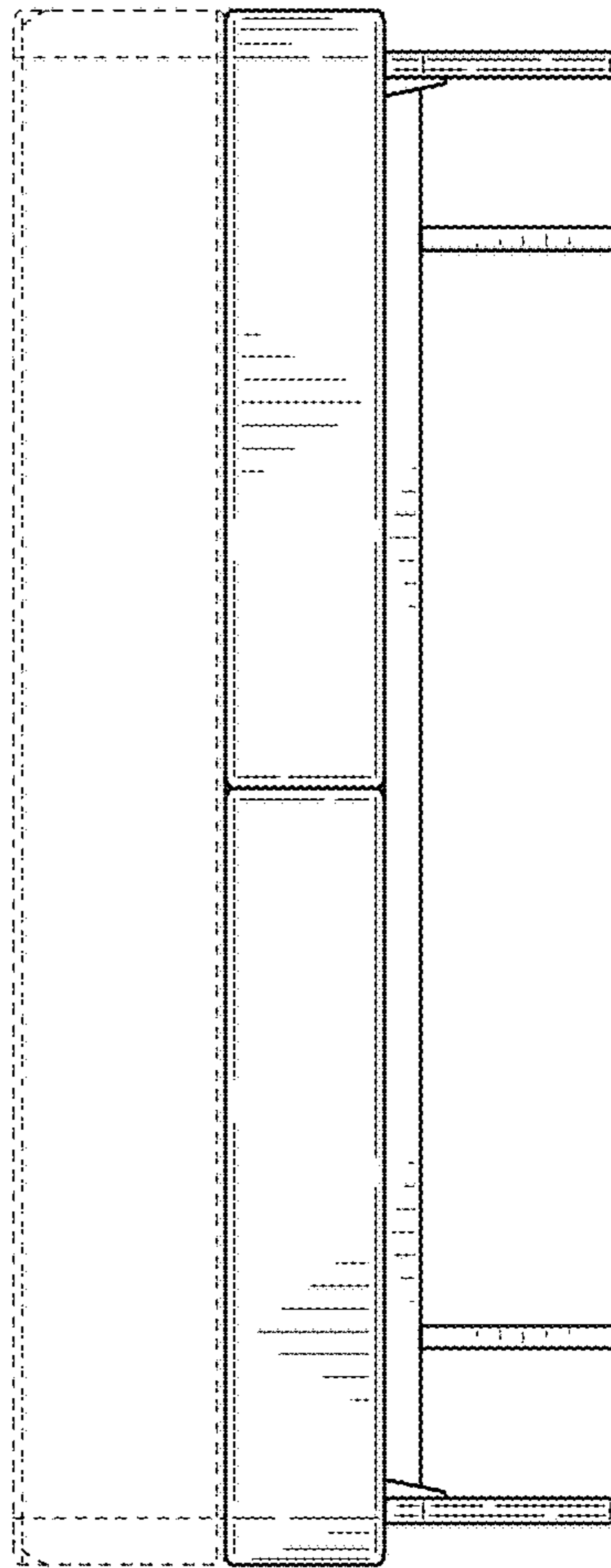

FIG. 12

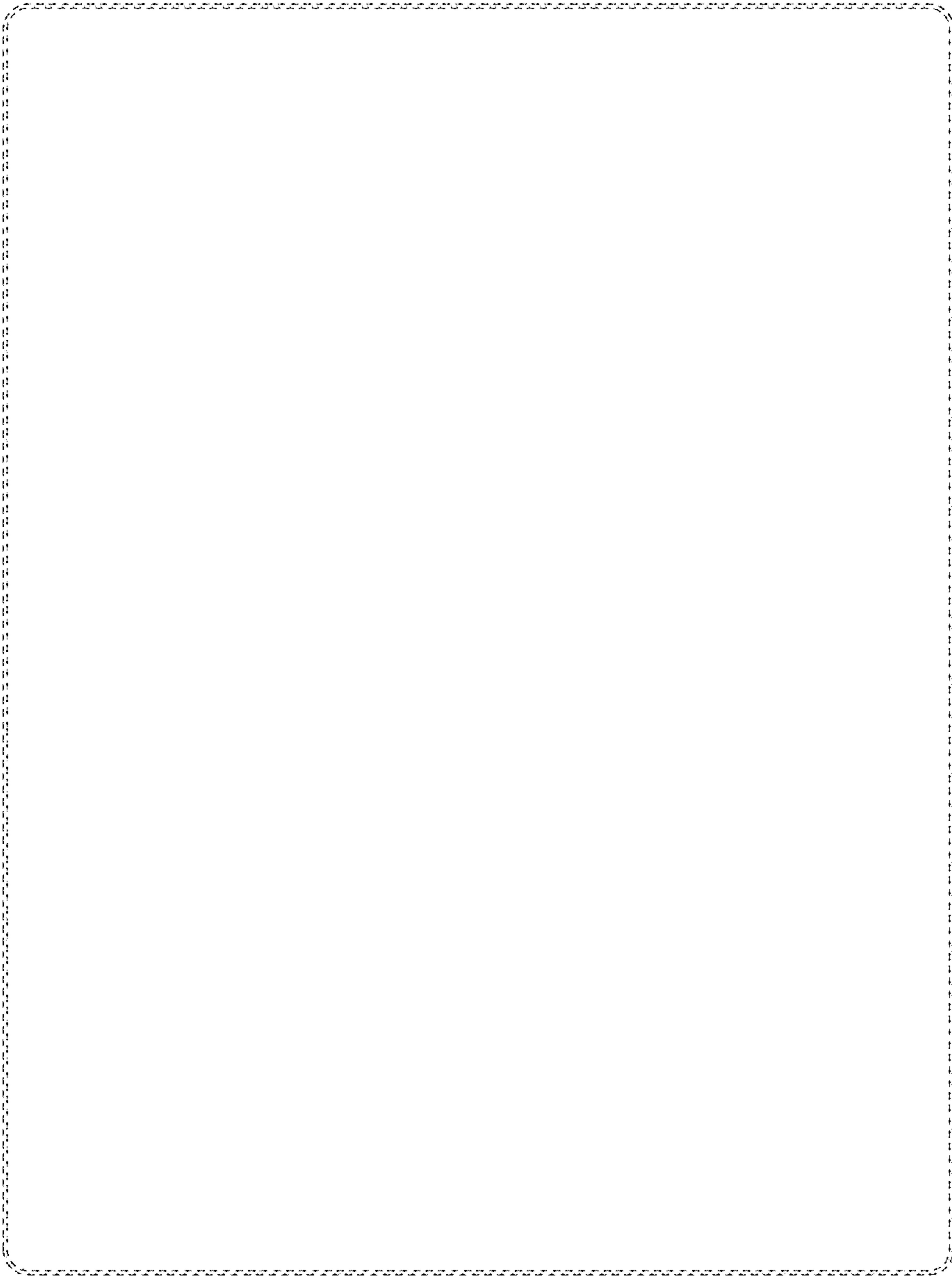

FIG.13

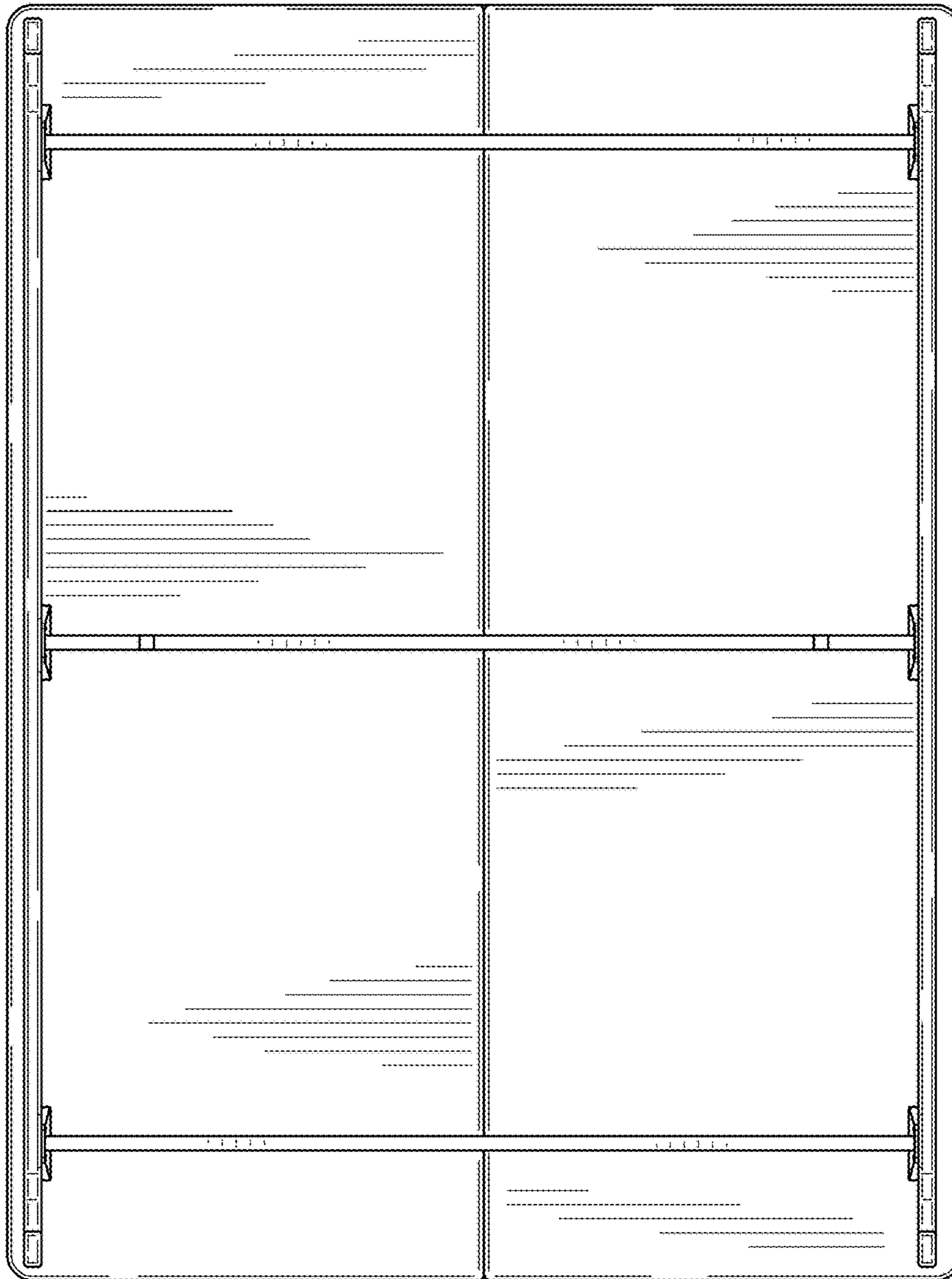

FIG.14