



US00D812376S

(12) **United States Design Patent**
Cogan

(10) **Patent No.:** **US D812,376 S**

(45) **Date of Patent:** **** Mar. 13, 2018**

(54) **GARMENT BAG**

(57) **CLAIM**

(71) Applicant: **The One Garment Bags, LLC,**
Brooklyn, NY (US)

The ornamental design for a garment bag, as shown and described.

(72) Inventor: **Sarah Cogan,** Brooklyn, NY (US)

(73) Assignee: **THE ONE GARMENT BAGS, LLC,**
Brooklyn, NY (US)

DESCRIPTION

(**) Term: **15 Years**

(21) Appl. No.: **29/566,954**

(22) Filed: **Jun. 3, 2016**

(51) **LOC (11) Cl.** **03-01**

(52) **U.S. Cl.**
USPC **D3/278**

(58) **Field of Classification Search**
USPC D3/273, 274, 276, 277, 285, 289, 301,
D3/901, 905, 902, 205, 280; D6/514
(Continued)

FIG. 1 is a first embodiment of a top, front, and right perspective view of a garment bag showing my new design; FIG. 2 is a bottom, rear, and left perspective view thereof; FIG. 3 is a front view thereof; FIG. 4 is a rear view thereof; FIG. 5 is a right side view thereof; FIG. 6 is a left side view thereof; FIG. 7 is a top view thereof; and FIG. 8 is a bottom view thereof.

FIG. 9 is a top, front, and right perspective view of a second embodiment of a garment bag showing my new design; FIG. 10 is a bottom, rear, and left perspective view thereof; FIG. 11 is a front view thereof; FIG. 12 is a rear view thereof; FIG. 13 is a right side view thereof; FIG. 14 is a left side view thereof; FIG. 15 is a top view thereof; and FIG. 16 is a bottom view thereof.

FIG. 17 is a top, front, and right perspective view of a third embodiment of a garment bag showing my new design; FIG. 18 is a bottom, rear, and left perspective view thereof; FIG. 19 is a front view thereof; FIG. 20 is a rear view thereof; FIG. 21 is a right side view thereof; FIG. 22 is a left side view thereof; FIG. 23 is a top view thereof; and, FIG. 24 is a bottom view thereof.

The portions of the garment bag shown in broken line represent thread stitching and form part of the claimed design.

(56) **References Cited**

U.S. PATENT DOCUMENTS

D499,548 S * 12/2004 Deuschendorf D3/278
D505,547 S * 5/2005 Whipple D3/278
(Continued)

OTHER PUBLICATIONS

Amazon, "The Ultimate Garment Bag", Accessed Jun. 14, 2017, Reviewed as early as Jun. 27, 2016. (https://www.amazon.com/dp/B01HLJIQVC?m=A1QJ2PARYJ9619&ref_=v_sp_widget_detail_page).*

(Continued)

Primary Examiner — Jennifer Rivard

Assistant Examiner — April Rivas

(74) *Attorney, Agent, or Firm* — Donald J. Ranft; Collen

1 Claim, 18 Drawing Sheets

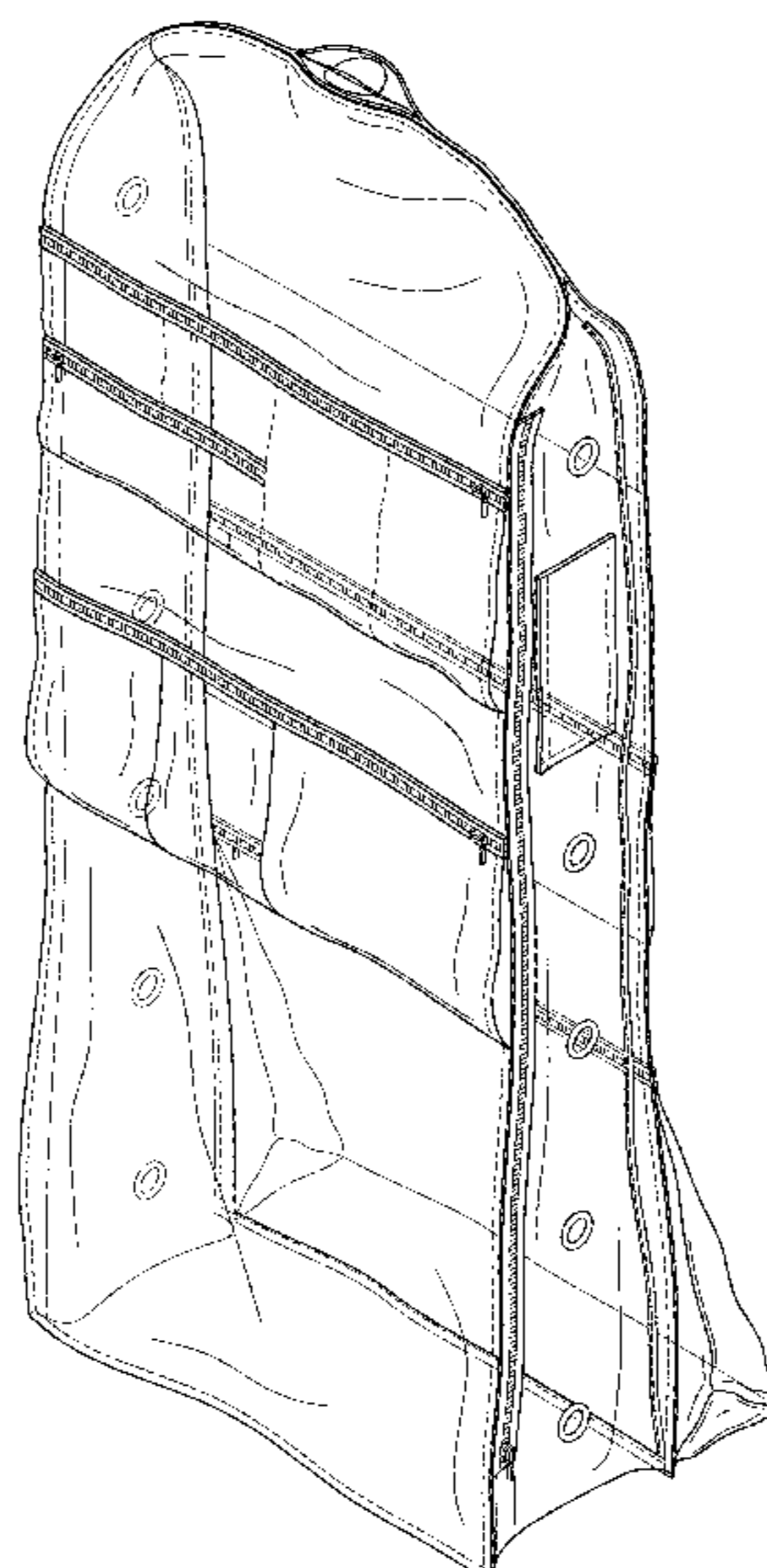

(58) **Field of Classification Search**

CPC B25H 3/00; B25H 3/006; B25H 3/021;
B25H 3/02; A45C 7/0077; A45C 7/00;
A47G 25/54

See application file for complete search history.

(56) **References Cited**

U.S. PATENT DOCUMENTS

D544,274 S * 6/2007 Hume D6/553
8,201,684 B2 * 6/2012 Torrellas A45C 3/004
206/279
D675,819 S * 2/2013 Cyterski D3/232
D744,229 S * 12/2015 Enders-Tretter D3/205
D747,099 S * 1/2016 Cogan D3/278
D769,003 S * 10/2016 Lee D6/315
2006/0086628 A1 * 4/2006 Deutschendorf A45C 3/004
206/287.1

OTHER PUBLICATIONS

Simply Caddy, "Costume Garment Bag Black Trim", Accessed Jun. 15, 2017, Reviewed as early as Mar. 28, 2017. (<http://www.simplycaddy.com/Simply-Caddy-Dance-Costume-Garment-Bag-p/sca006.htm>).*

* cited by examiner

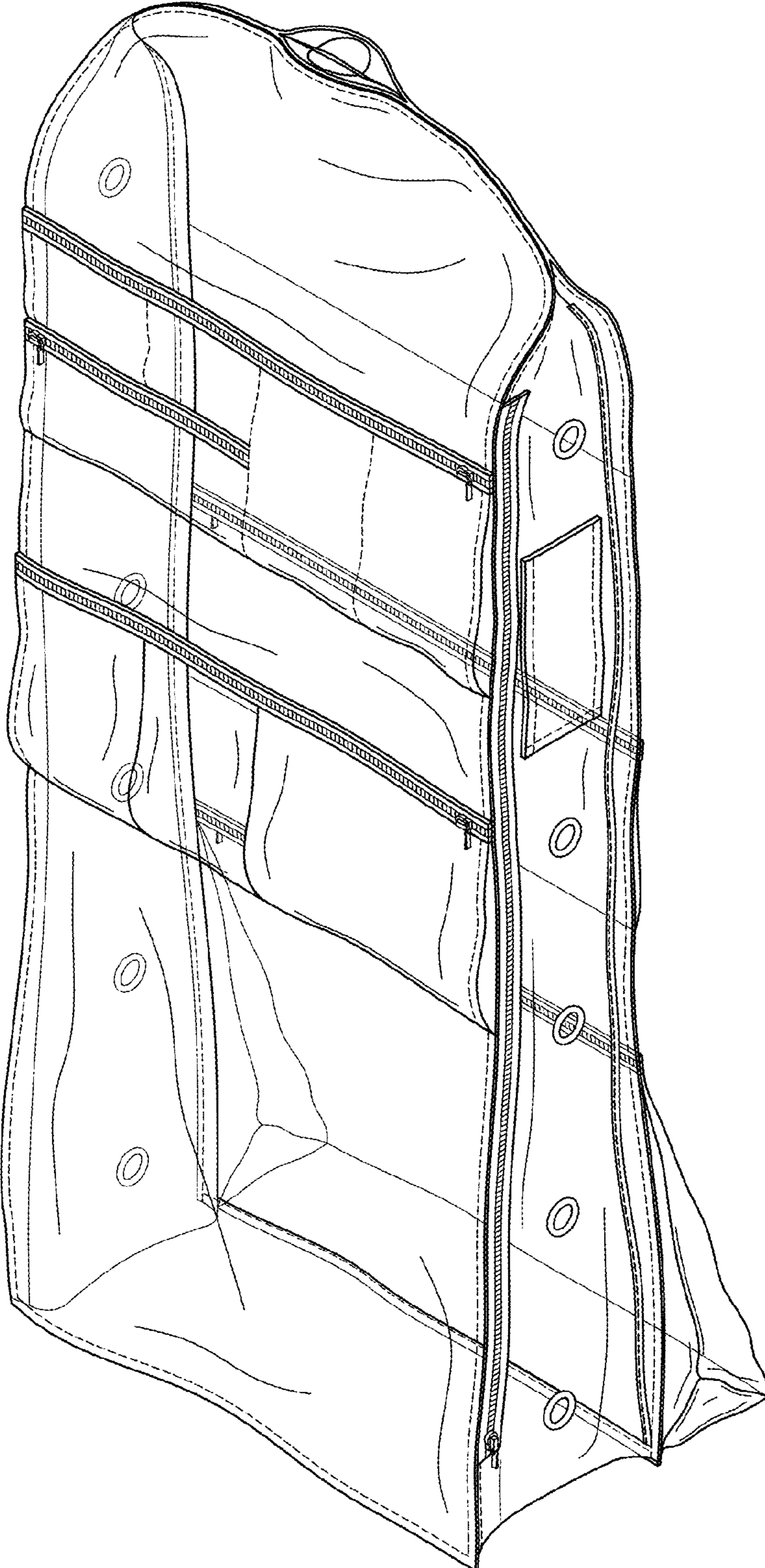

FIG. 1

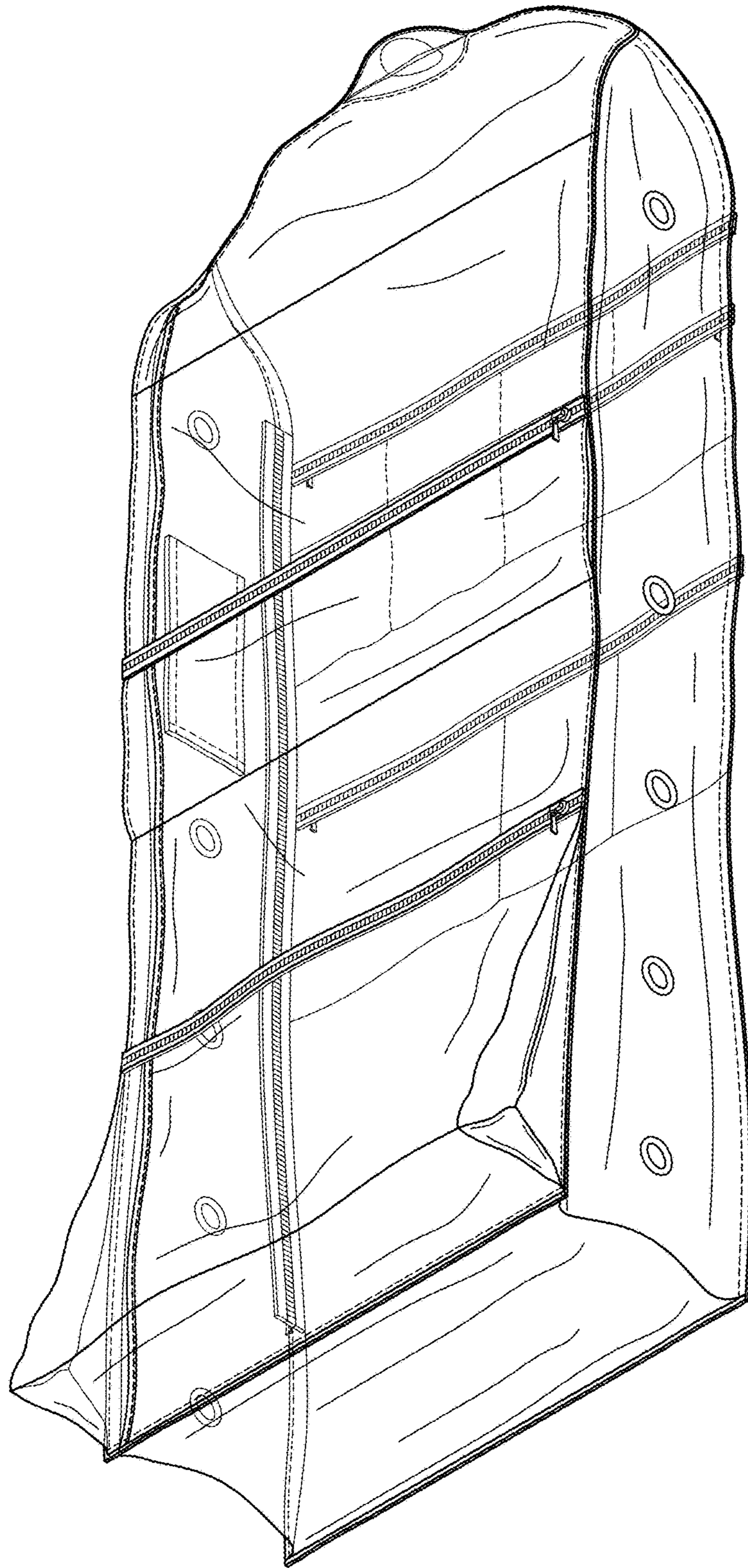

FIG. 2

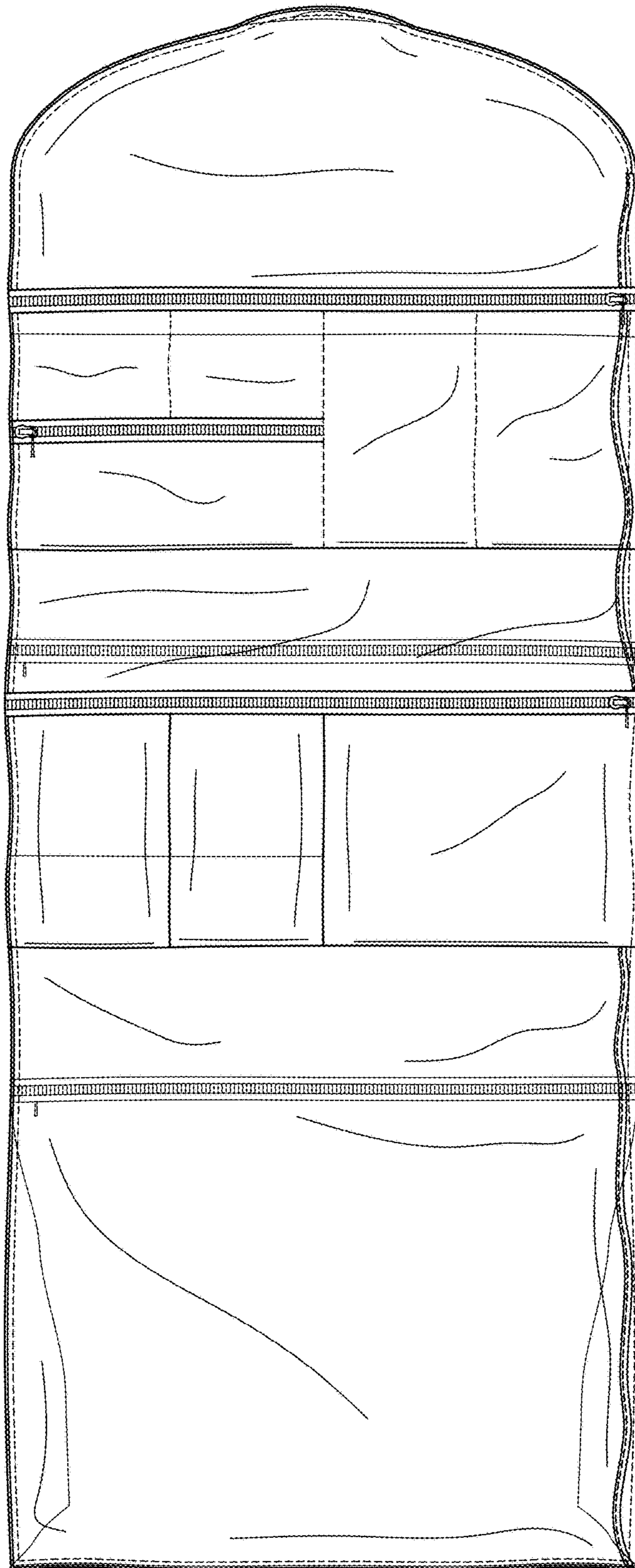

FIG. 3

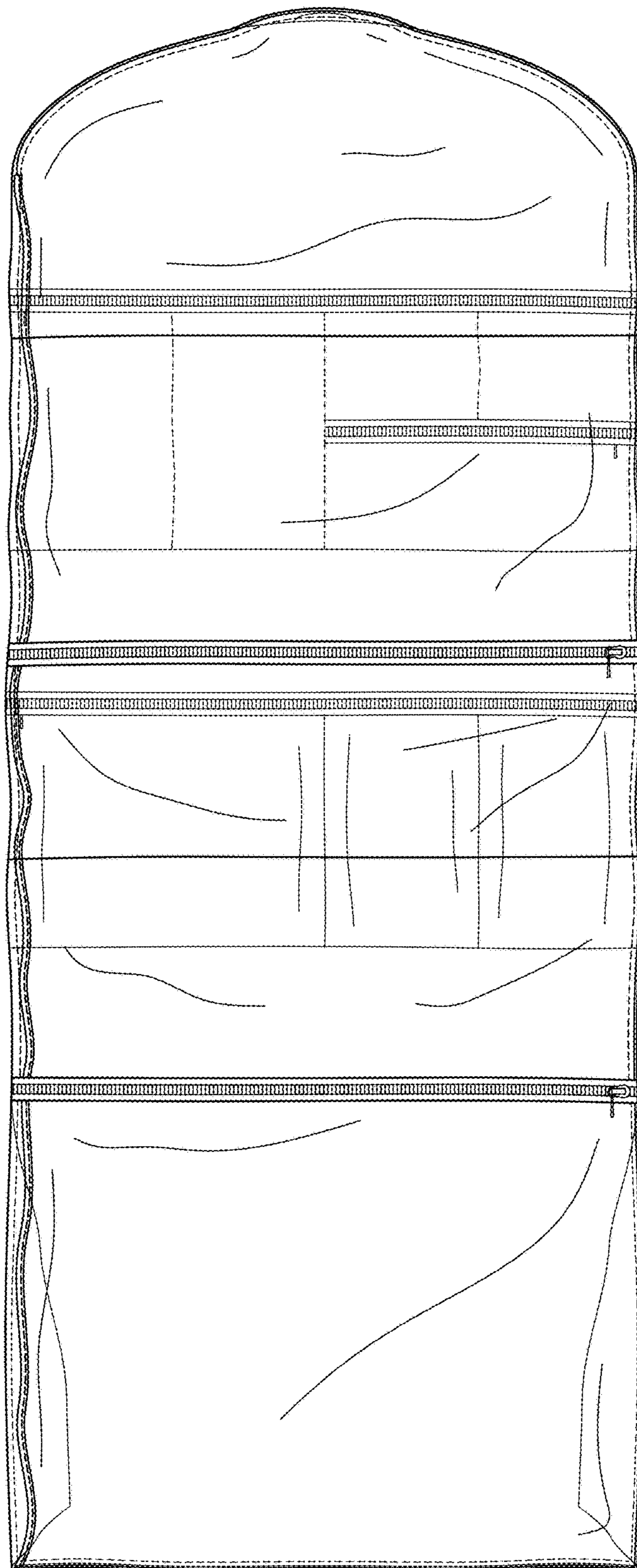

FIG. 4

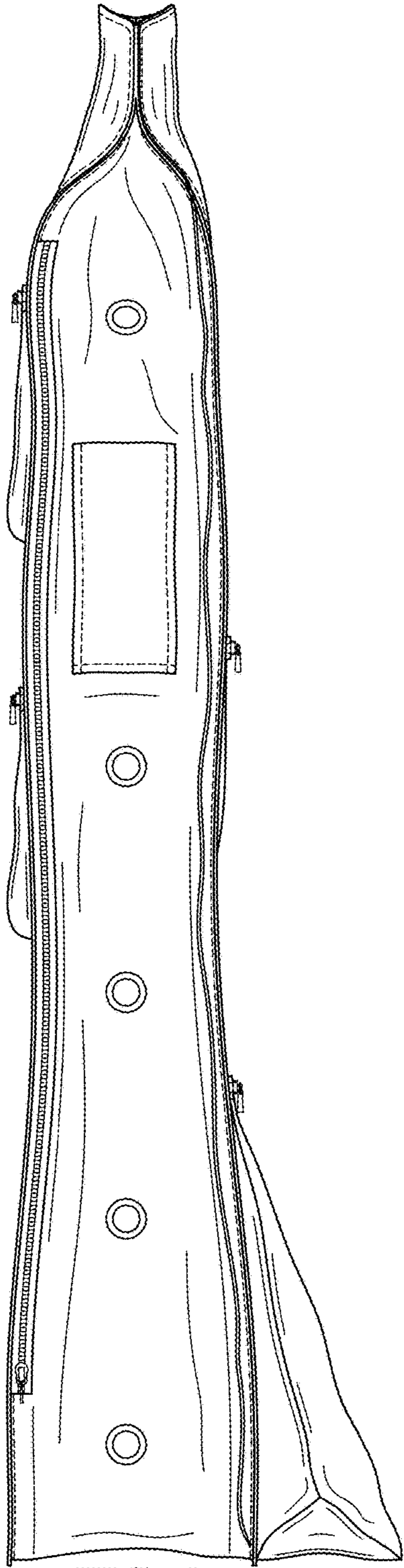

FIG. 5

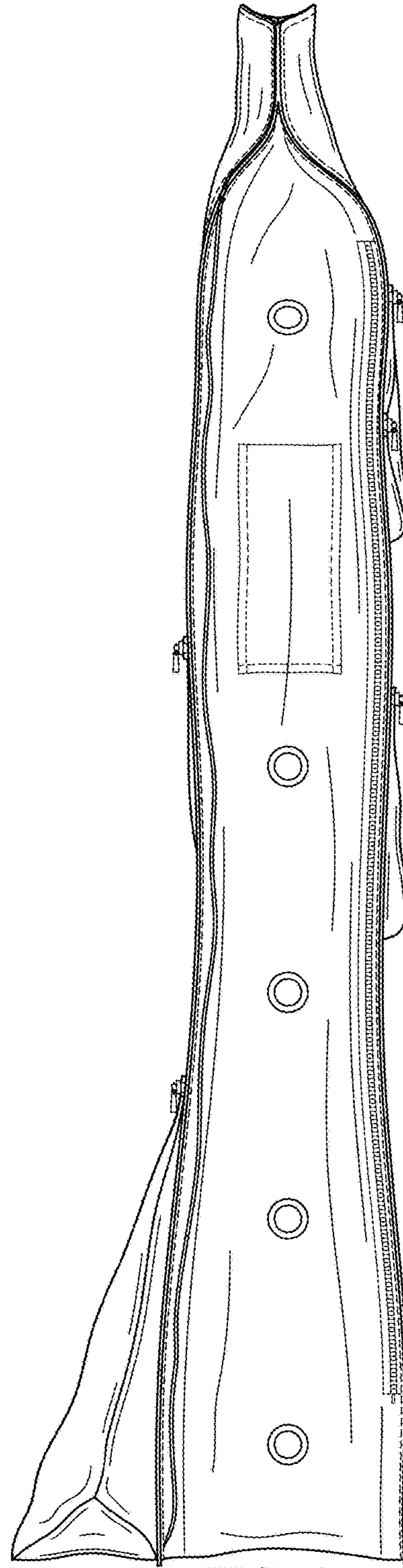

FIG. 6

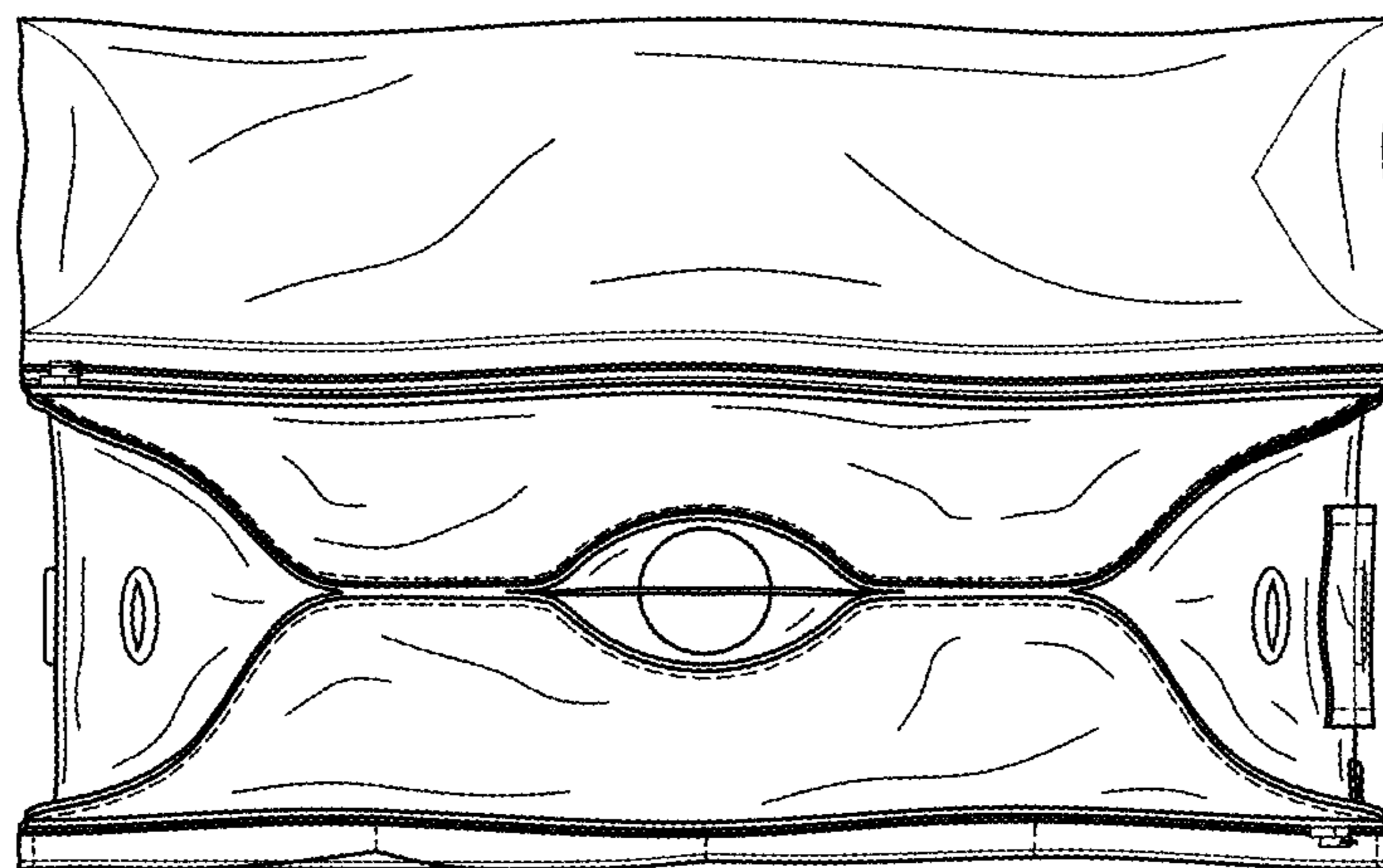

FIG. 7

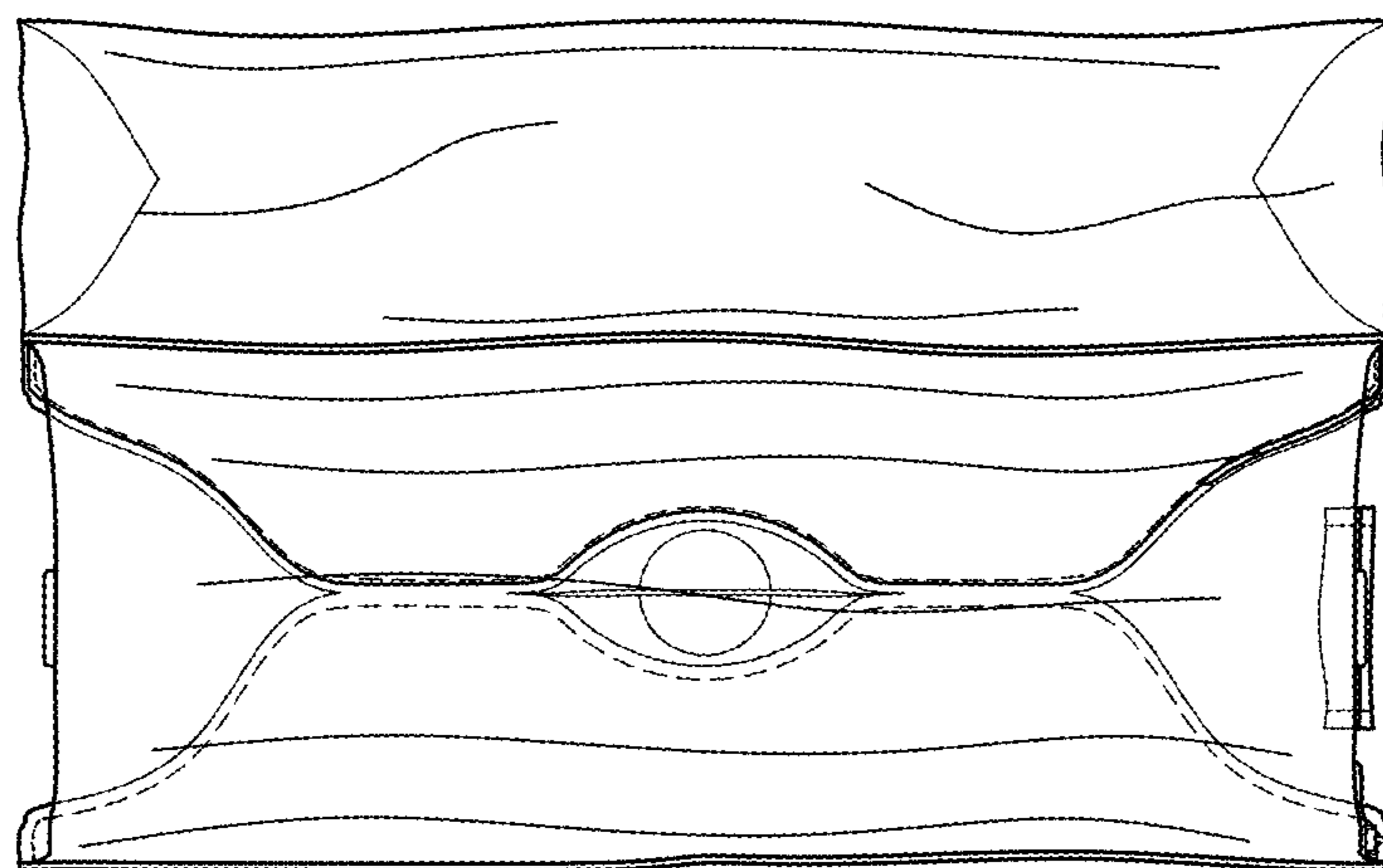

FIG. 8

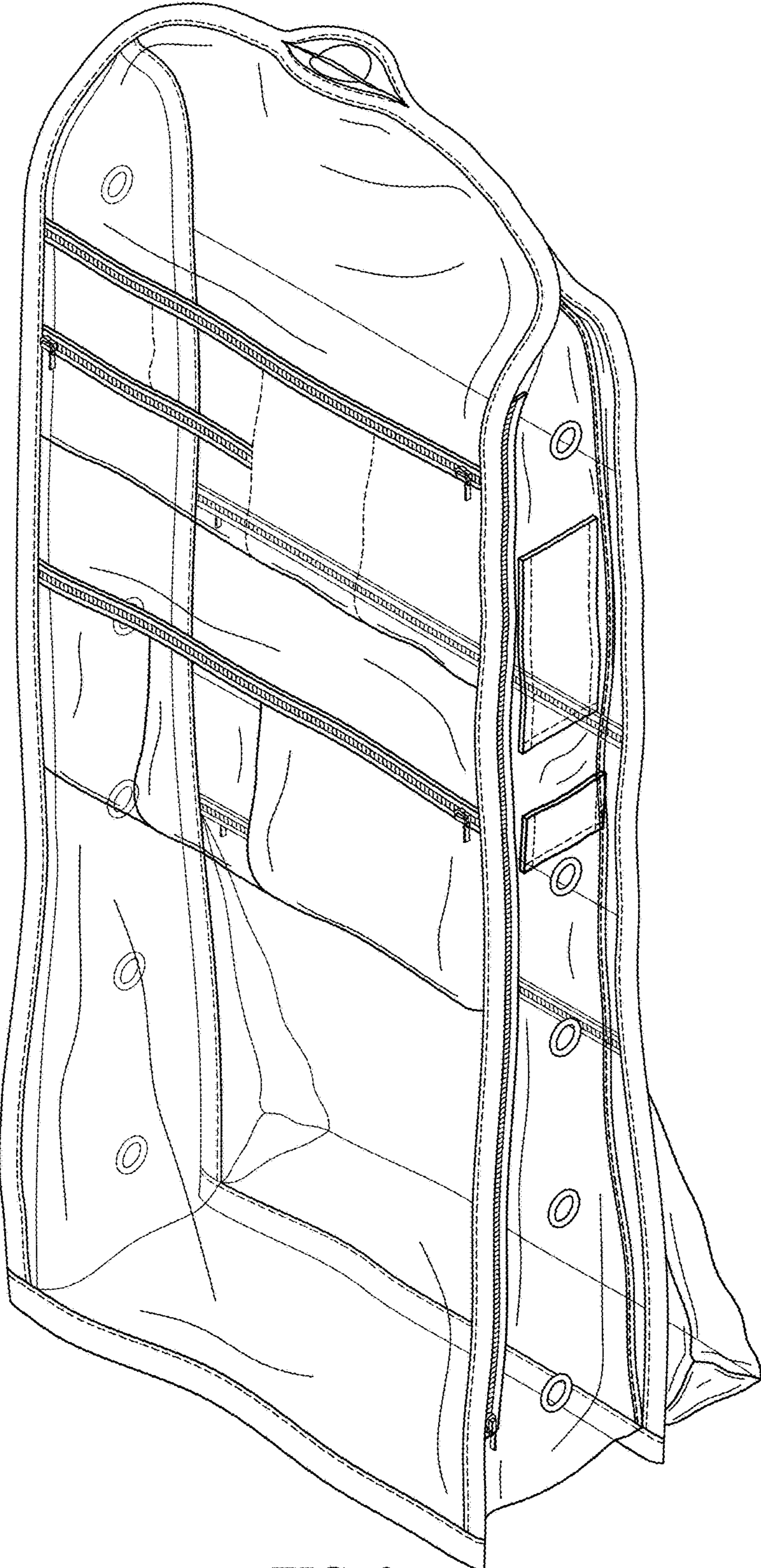

FIG. 9

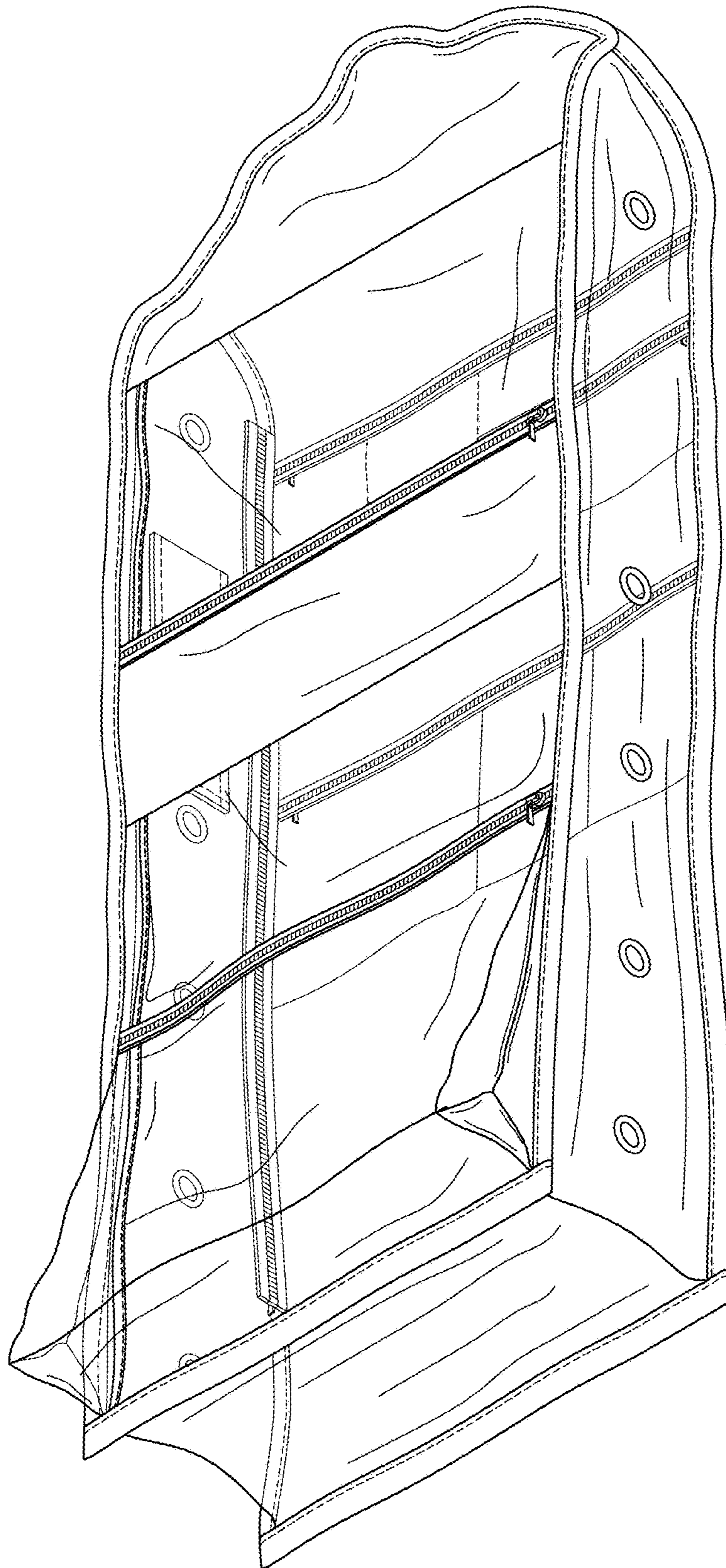

FIG. 10

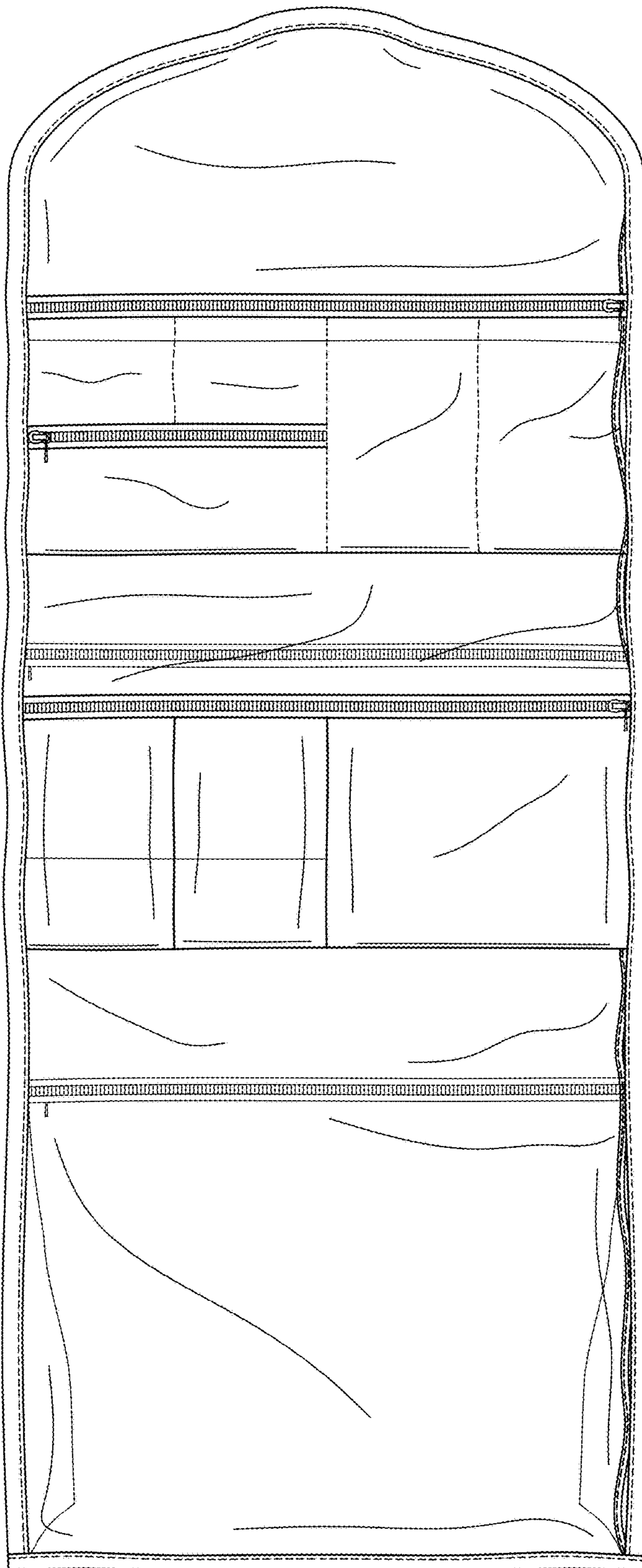

FIG. 11

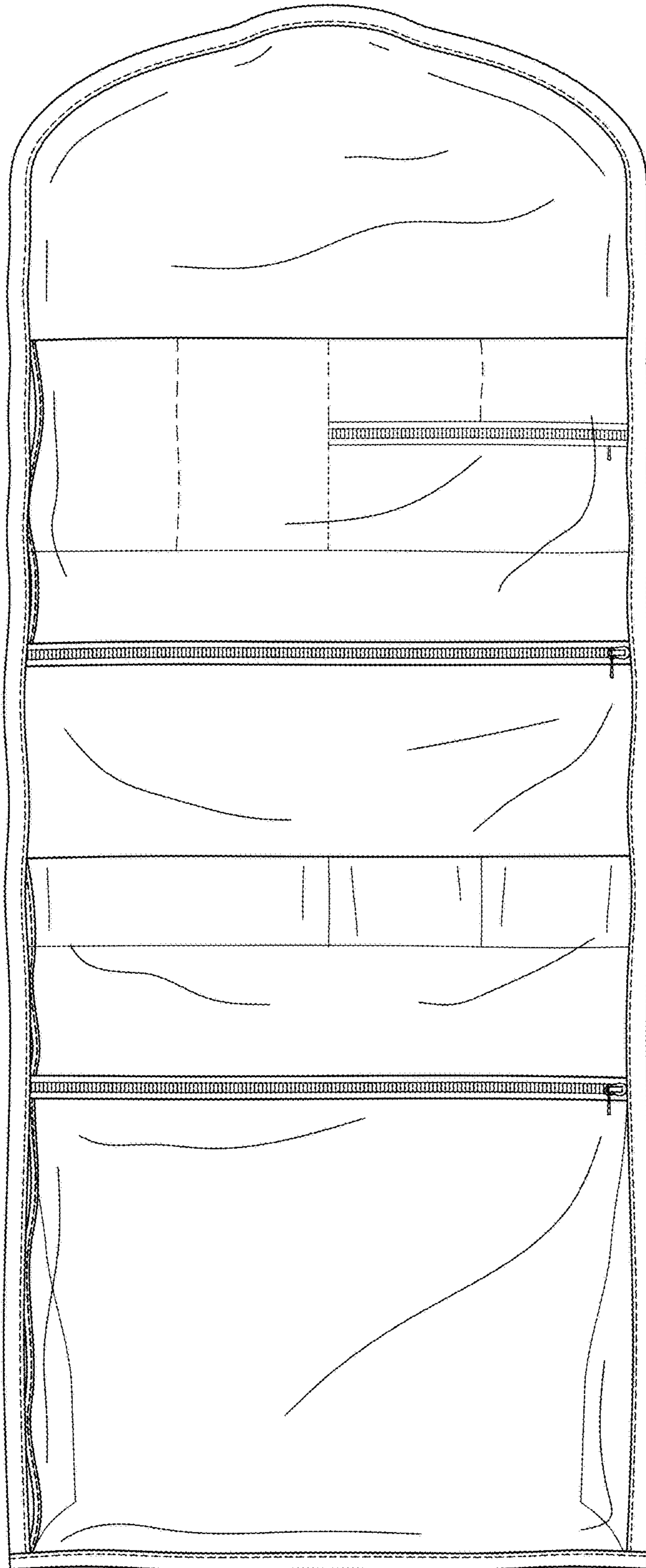

FIG. 12

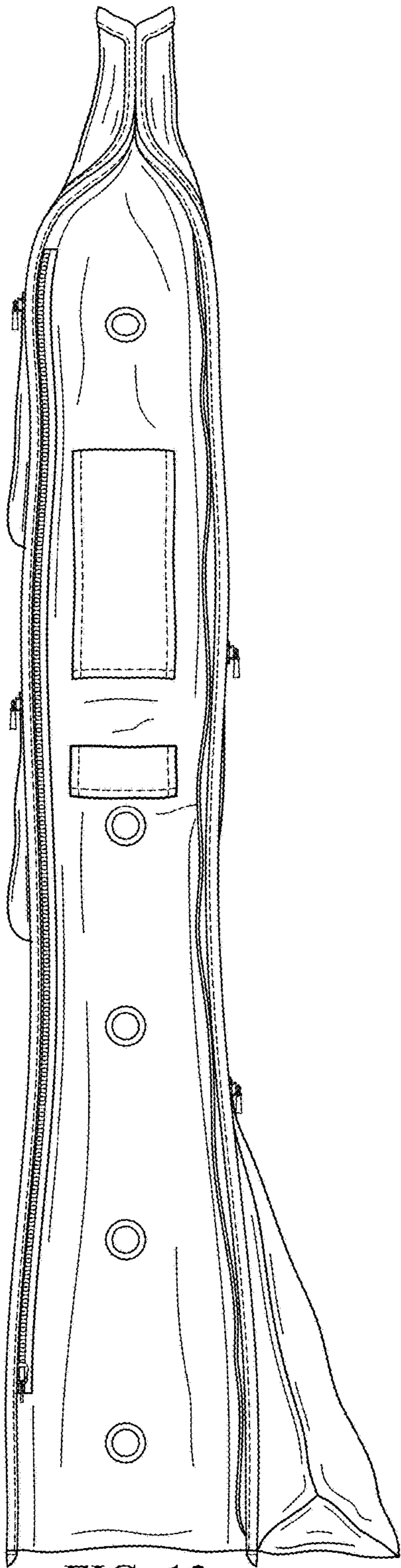

FIG. 13

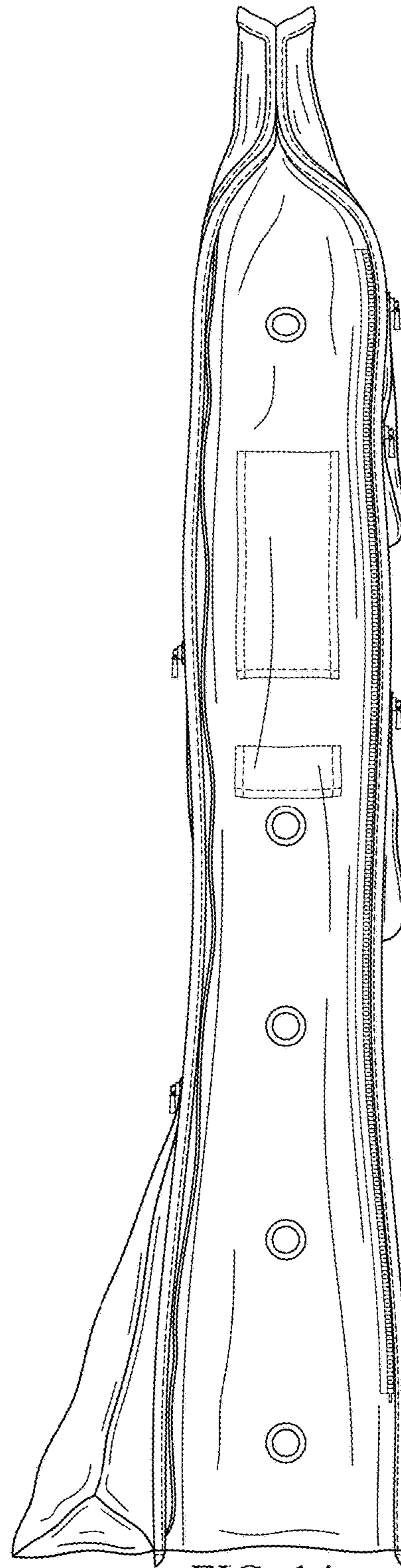

FIG. 14

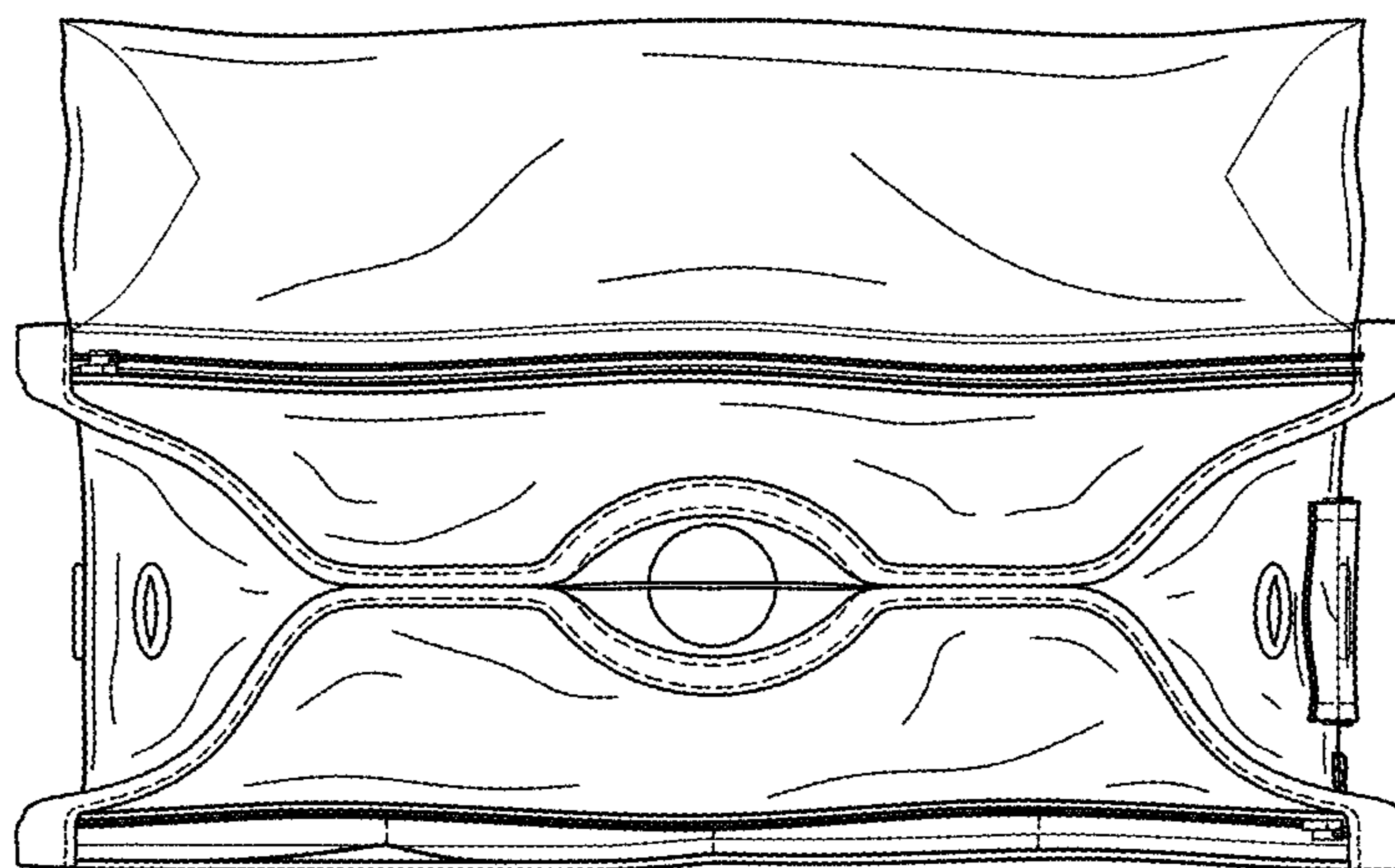

FIG. 15

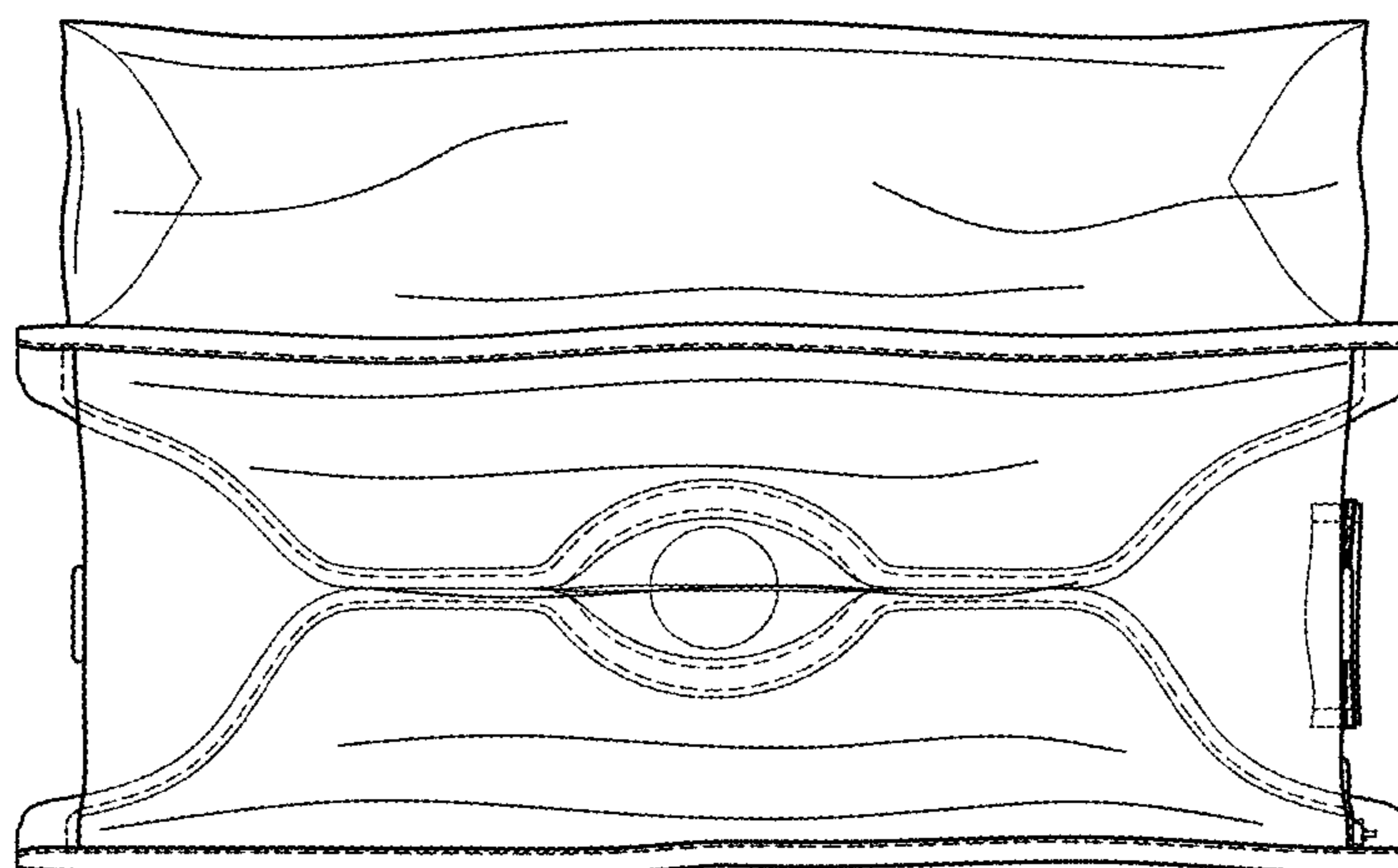

FIG. 16

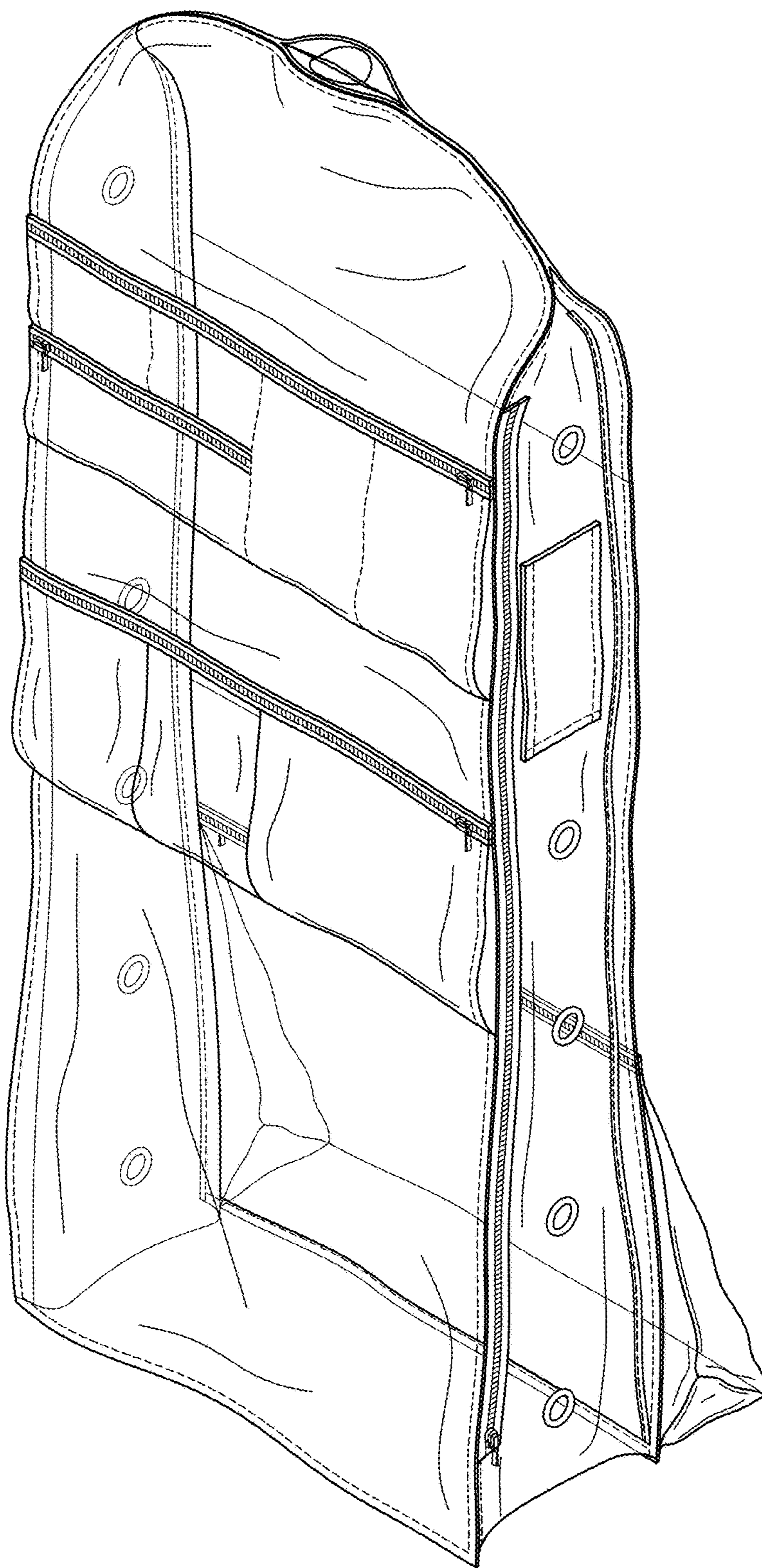

FIG. 17

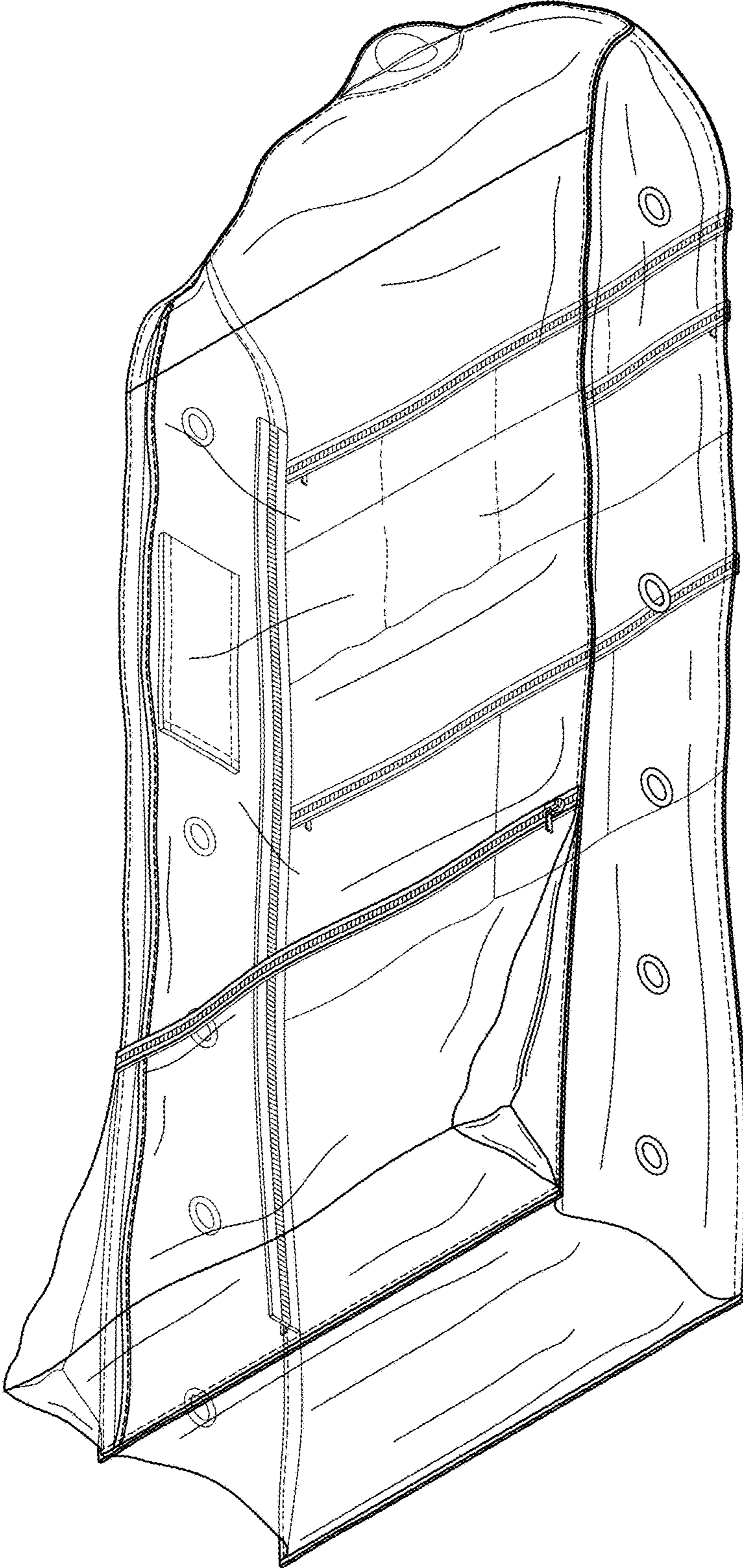

FIG. 18

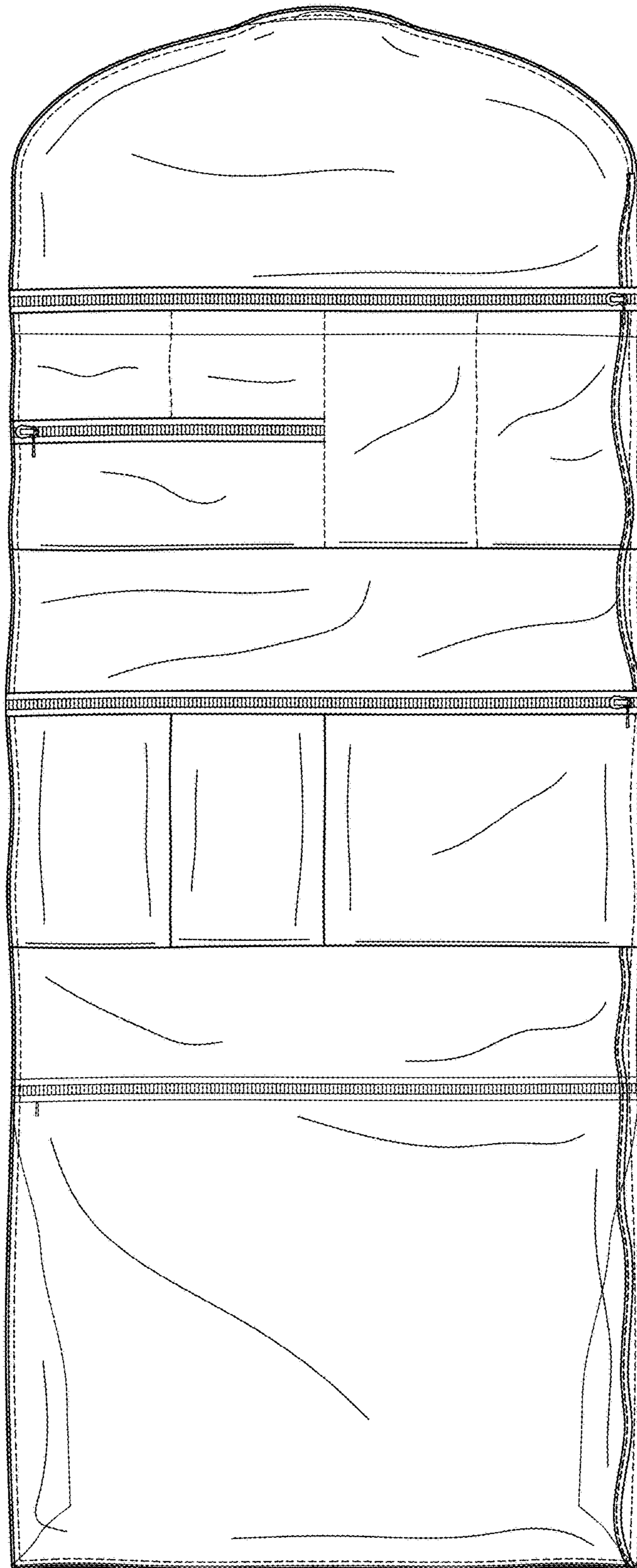

FIG. 19

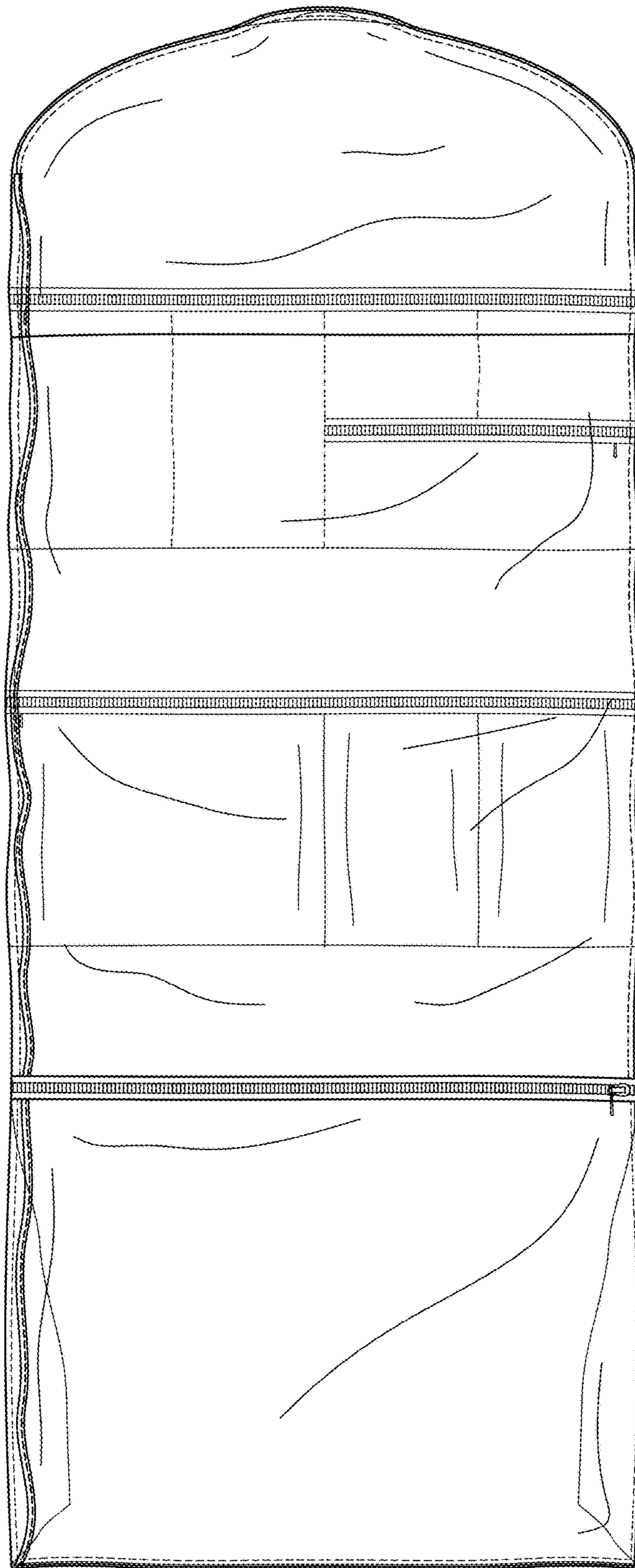

FIG. 20

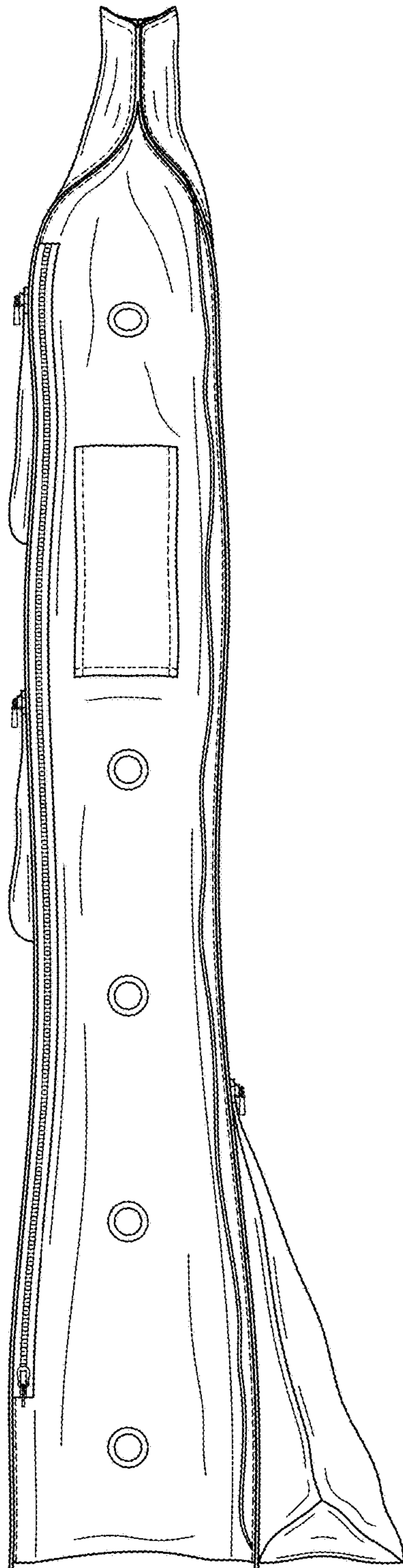

FIG. 21

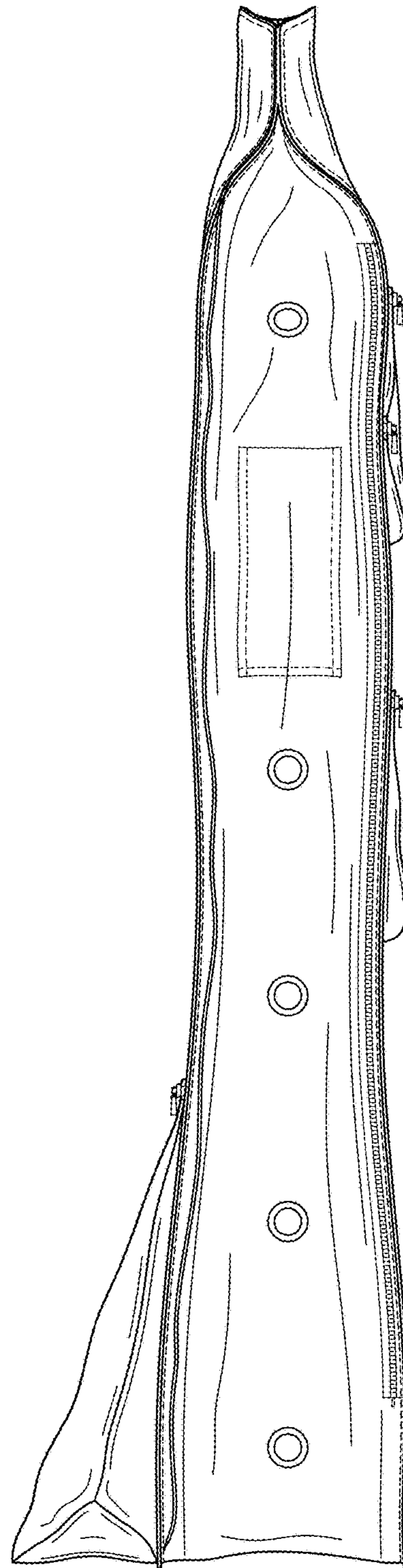

FIG. 22

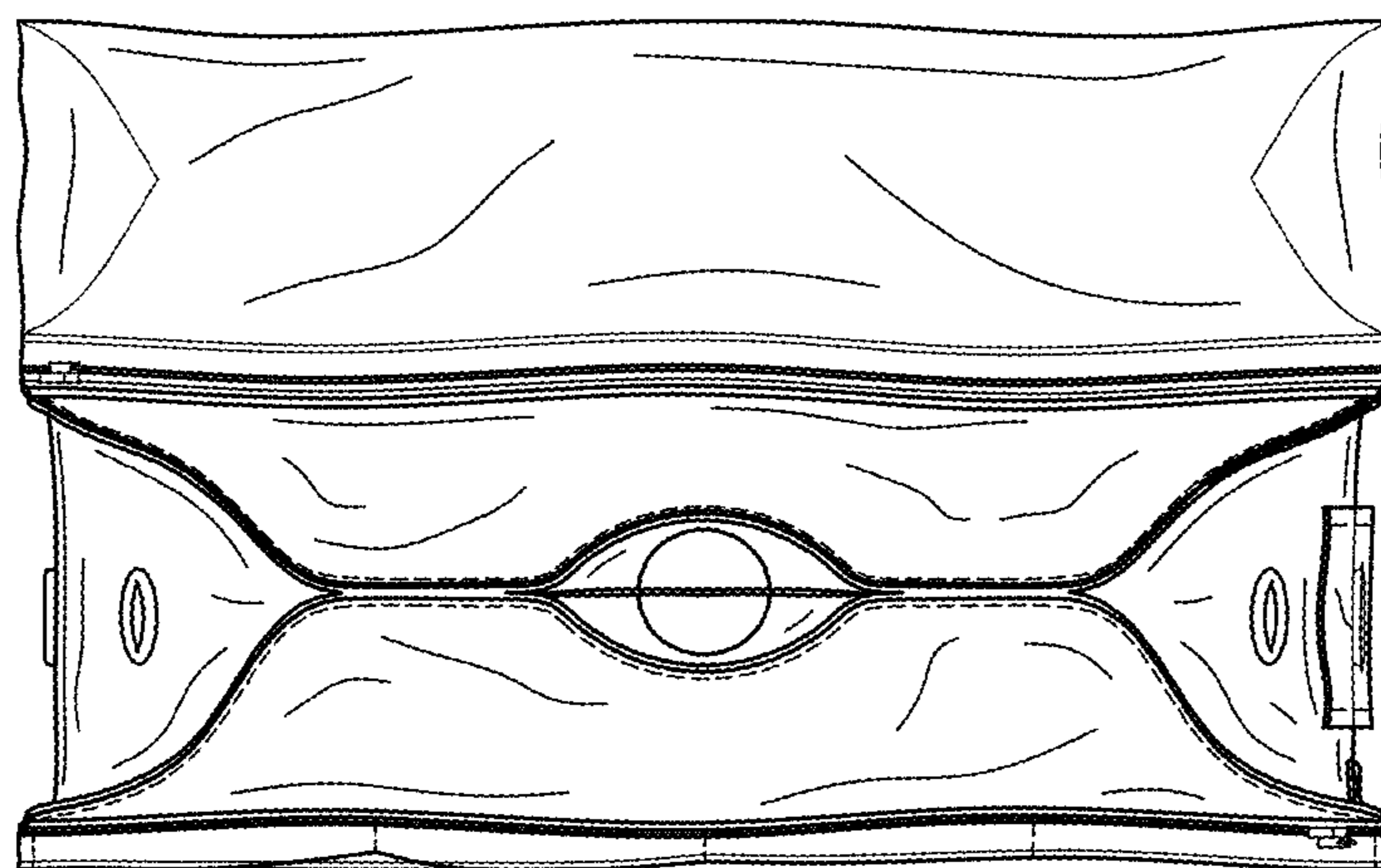

FIG. 23

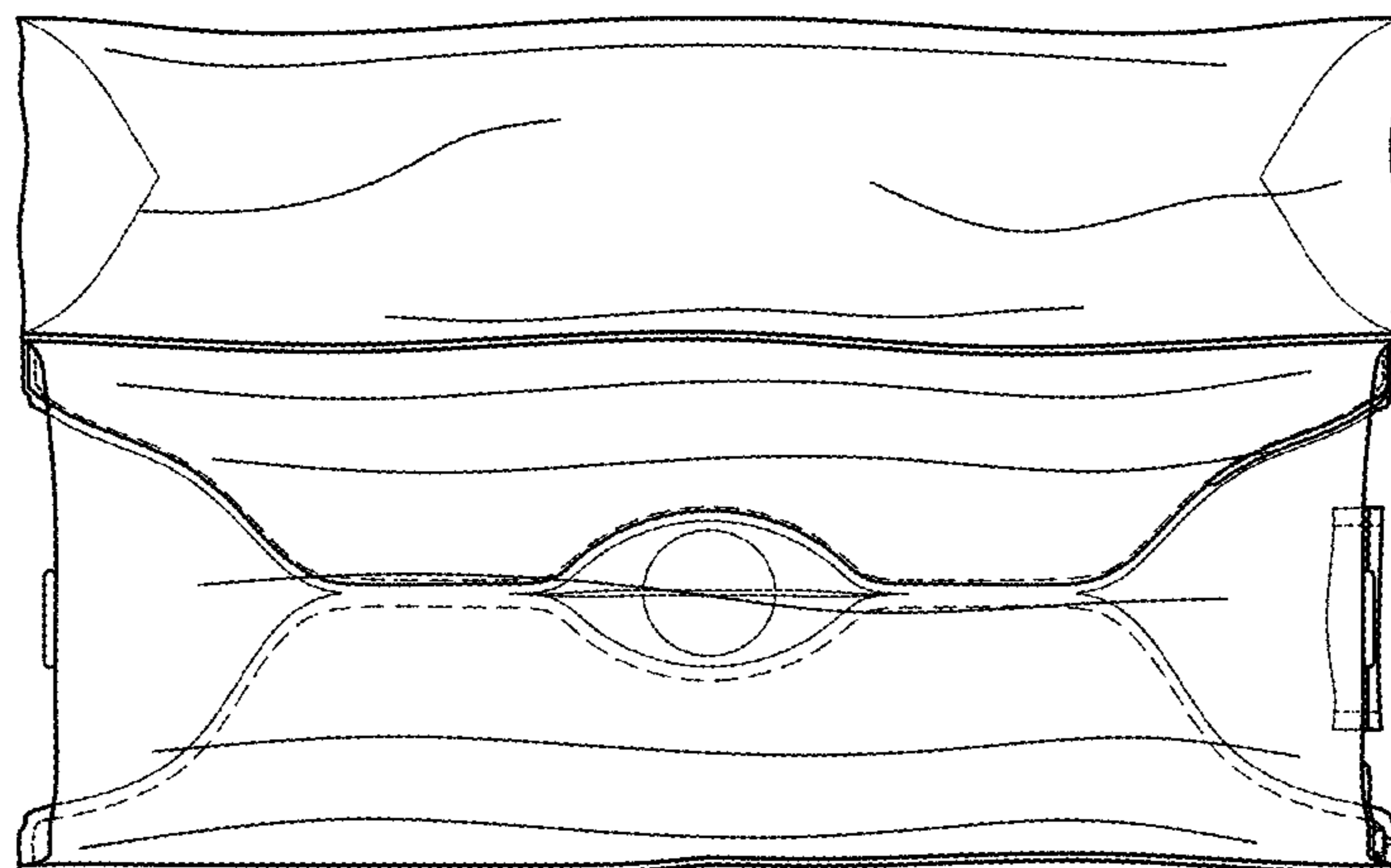

FIG. 24