



US00D812375S

(12) **United States Design Patent**
Albert et al.

(10) **Patent No.:** **US D812,375 S**
(45) **Date of Patent:** **** Mar. 13, 2018**

(54) **STACKABLE CONTAINER**
(71) Applicant: **PITH PRODUCTS LLC**, Ashford, CT (US)
(72) Inventors: **Louis Albert**, Woodstock, CT (US);
Lance Bouchard, Woodstock, CT (US)
(**) Term: **15 Years**
(21) Appl. No.: **29/562,042**
(22) Filed: **Apr. 21, 2016**
(51) **LOC (11) Cl.** **03-01**
(52) **U.S. Cl.**
USPC **D3/276**
(58) **Field of Classification Search**
USPC D3/201, 203.1, 203.2, 203.6, 203.7,
D3/203.8, 202, 204, 205, 206, 247, 272,
D3/273, 276, 281, 282, 292, 294, 315,
D3/901, 903, 904, 905, 302, 265;
D9/600, 643, 644, 645, 651, 655, 657,
D9/420, 423, 424, 425, 430, 431, 432;
D14/480.1, 480.2, 480.3, 480.5; D24/110
CPC B65D 21/0223; B65D 21/005; B65D
81/022; B65D 19/04
See application file for complete search history.

8,789,699 B2 * 7/2014 Patstone B65D 21/0223
206/503
D742,642 S * 11/2015 Aronoff D3/302
D773,817 S * 12/2016 Hower D3/282
2016/0311600 A1 * 10/2016 Albert B65D 21/0223

OTHER PUBLICATIONS

etrailer.com. Powerhouse Strap-style Battery Box for Group 24 Batteries—Vented. First reviewed Apr. 8, 2013. Retrieved Dec. 21, 2016. (<https://www.etrailer.com/AccessoriesandParts/Powerhouse/PH13034.html>).*

* cited by examiner

Primary Examiner — Jennifer Rivard
Assistant Examiner — Jerry Shiuian-Hua Hsu
(74) *Attorney, Agent, or Firm* — Damian Wasserbauer, Esq.; Wasserbauer Law LLC

(57) **CLAIM**

The ornamental design for a stackable container, as shown and described.

DESCRIPTION

FIG. 1 is a perspective view illustrating a stackable container of the invention, showing our new design;
FIG. 2 is a front view illustrating the stackable container of the invention, the rear view being a mirror image thereof;
FIG. 3 is a left side views illustrating the stackable container of the invention, the right side view being a mirror image thereof;
FIG. 4 is a top view illustrating the stackable container of the invention; and,
FIG. 5 is a bottom view illustrating the stackable container of the invention.
The broken lines illustrate portions of the article and form no part of the-claimed design.

(56) **References Cited**

U.S. PATENT DOCUMENTS

D201,398 S * 6/1965 Burns D3/302
D234,273 S * 2/1975 Wilson D3/272
D238,978 S * 2/1976 Gretchell, Jr. D3/272
D238,979 S * 2/1976 Perry D24/110
4,042,111 A * 8/1977 Smith B65D 19/04
206/508
D293,624 S * 1/1988 Sherman D3/265
D441,954 S * 5/2001 Parker D3/273
6,253,948 B1 * 7/2001 Ficker B65D 21/0223
220/350
D518,957 S * 4/2006 DeCarlo D3/302

1 Claim, 5 Drawing Sheets

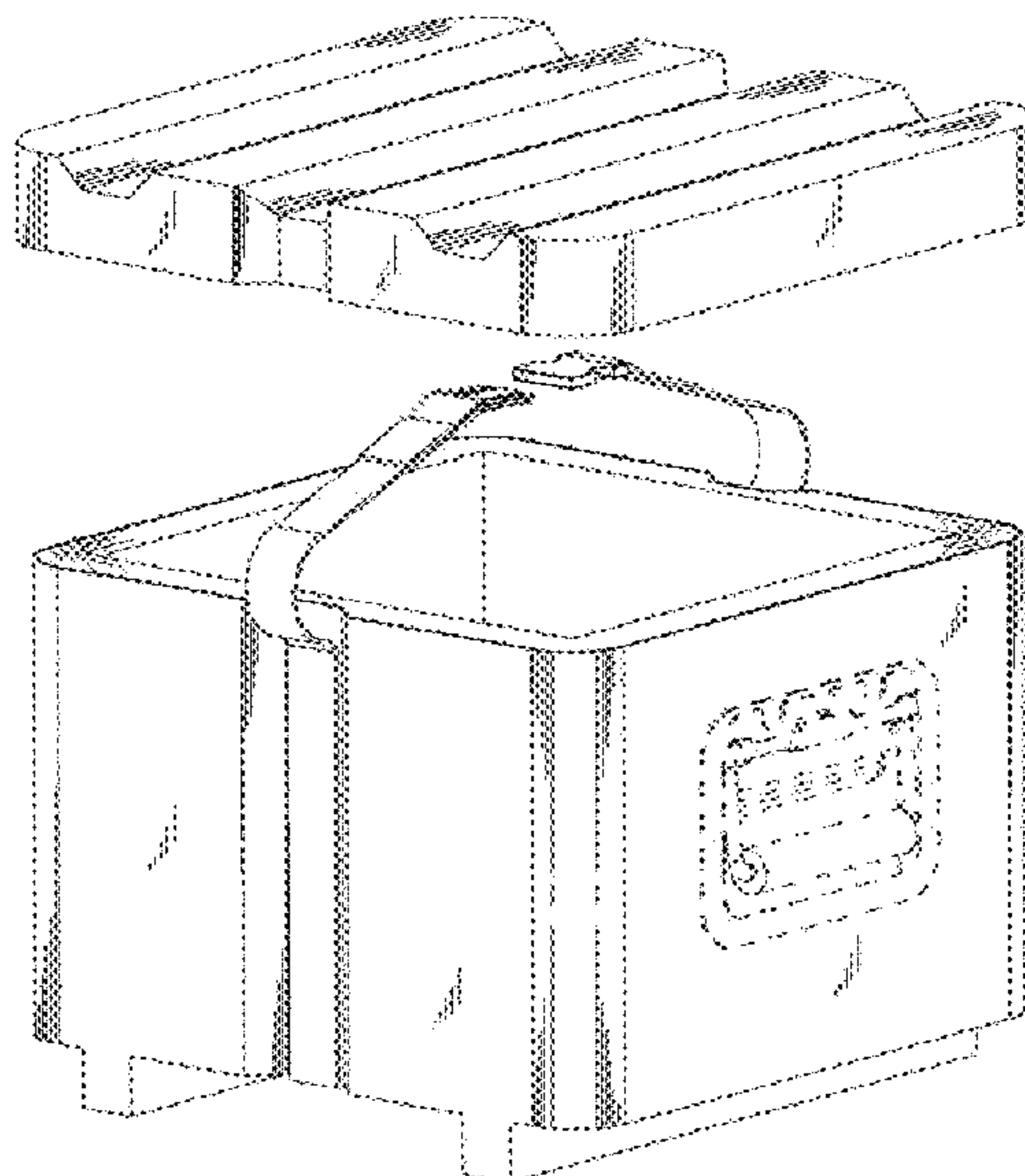

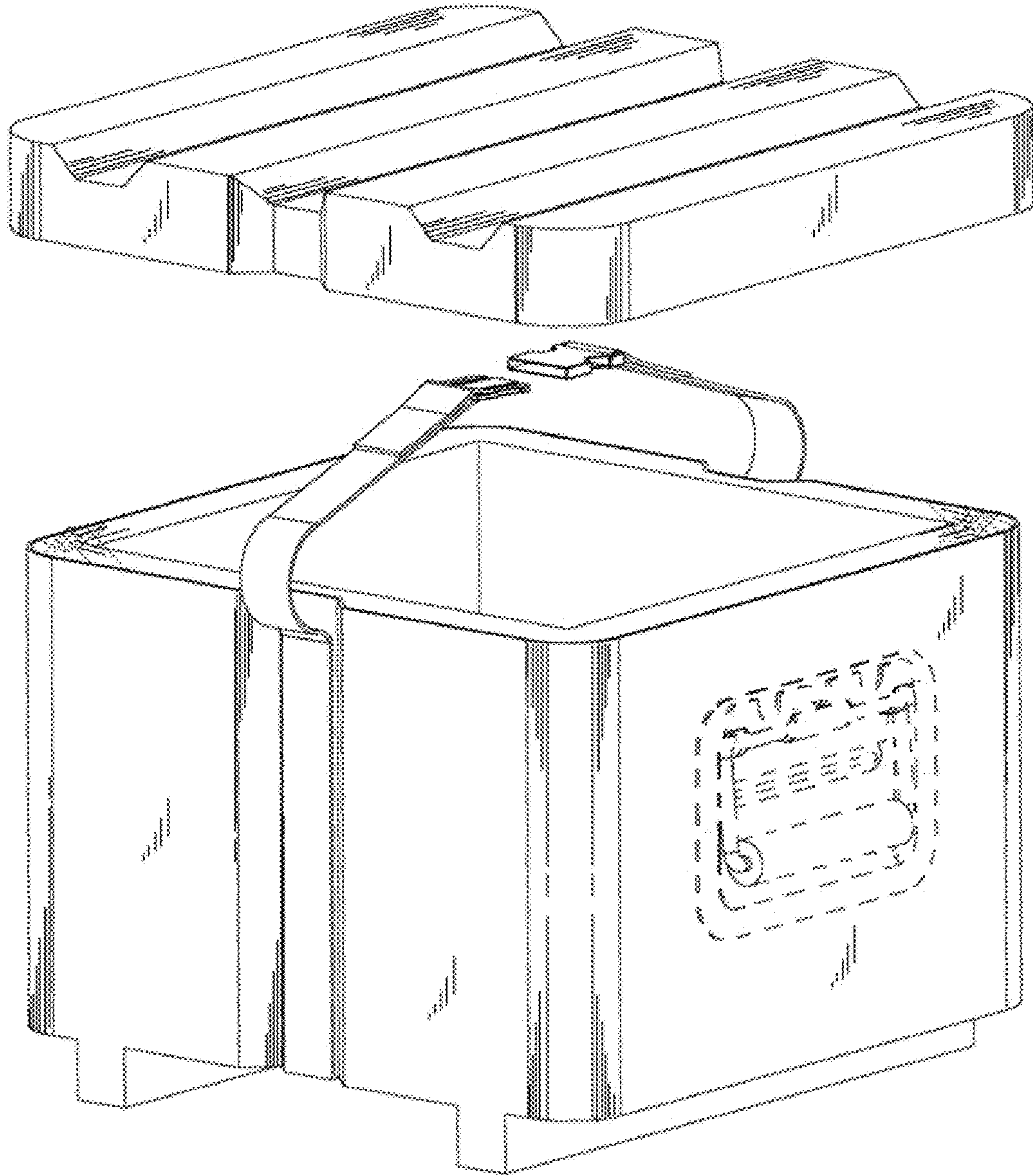

FIG. 1

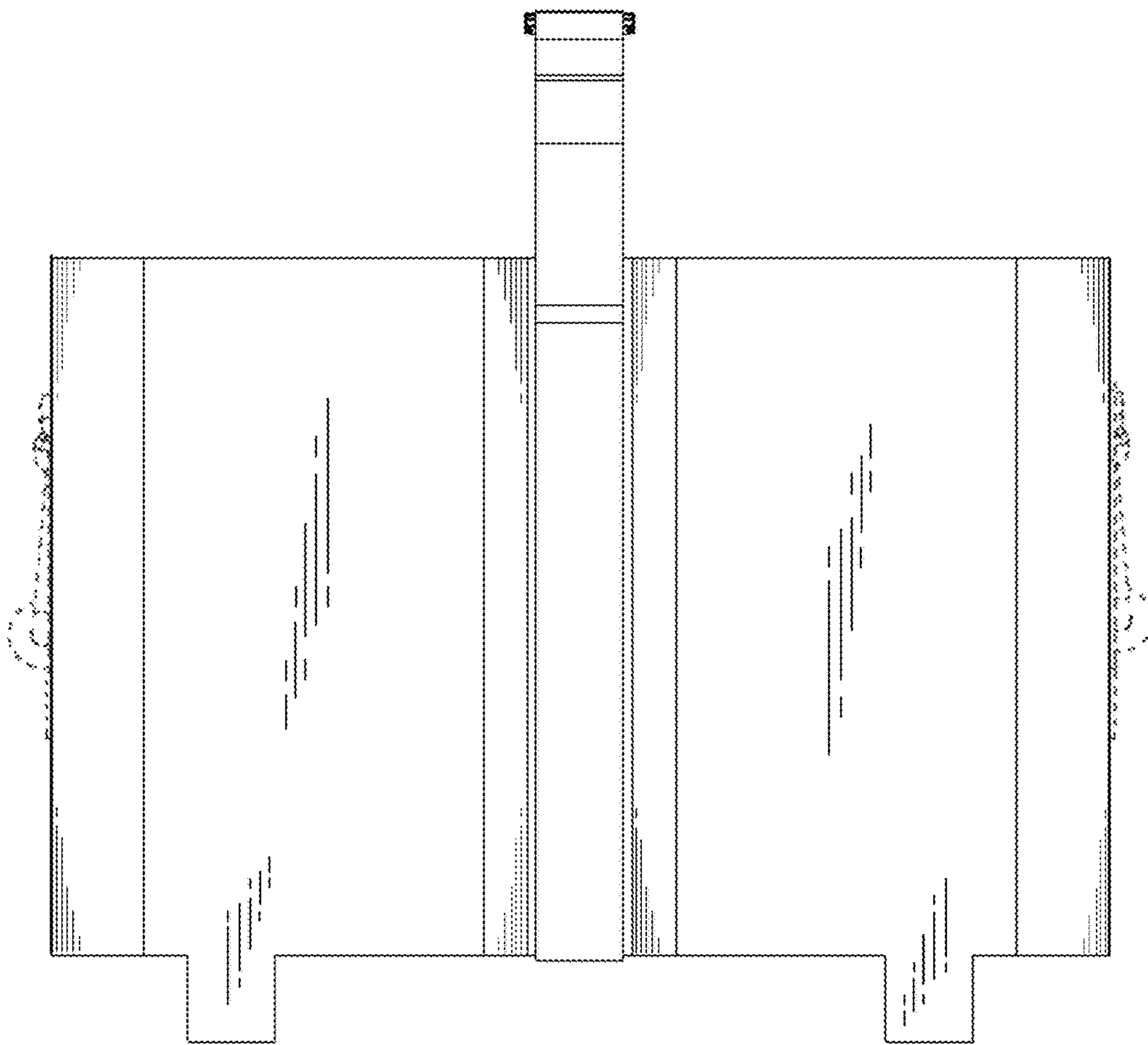
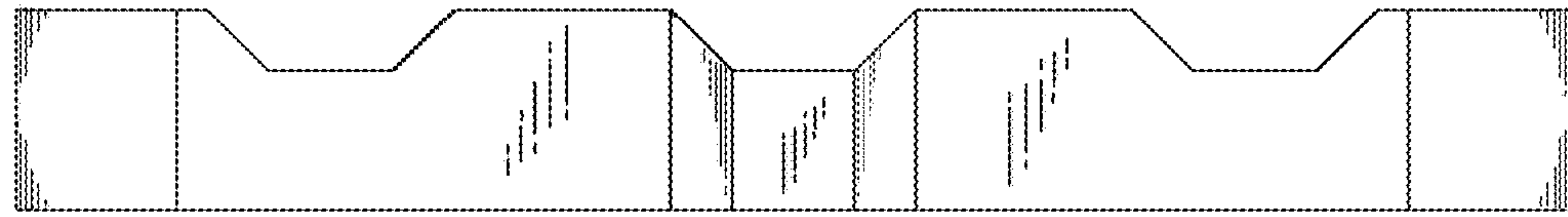

FIG. 2

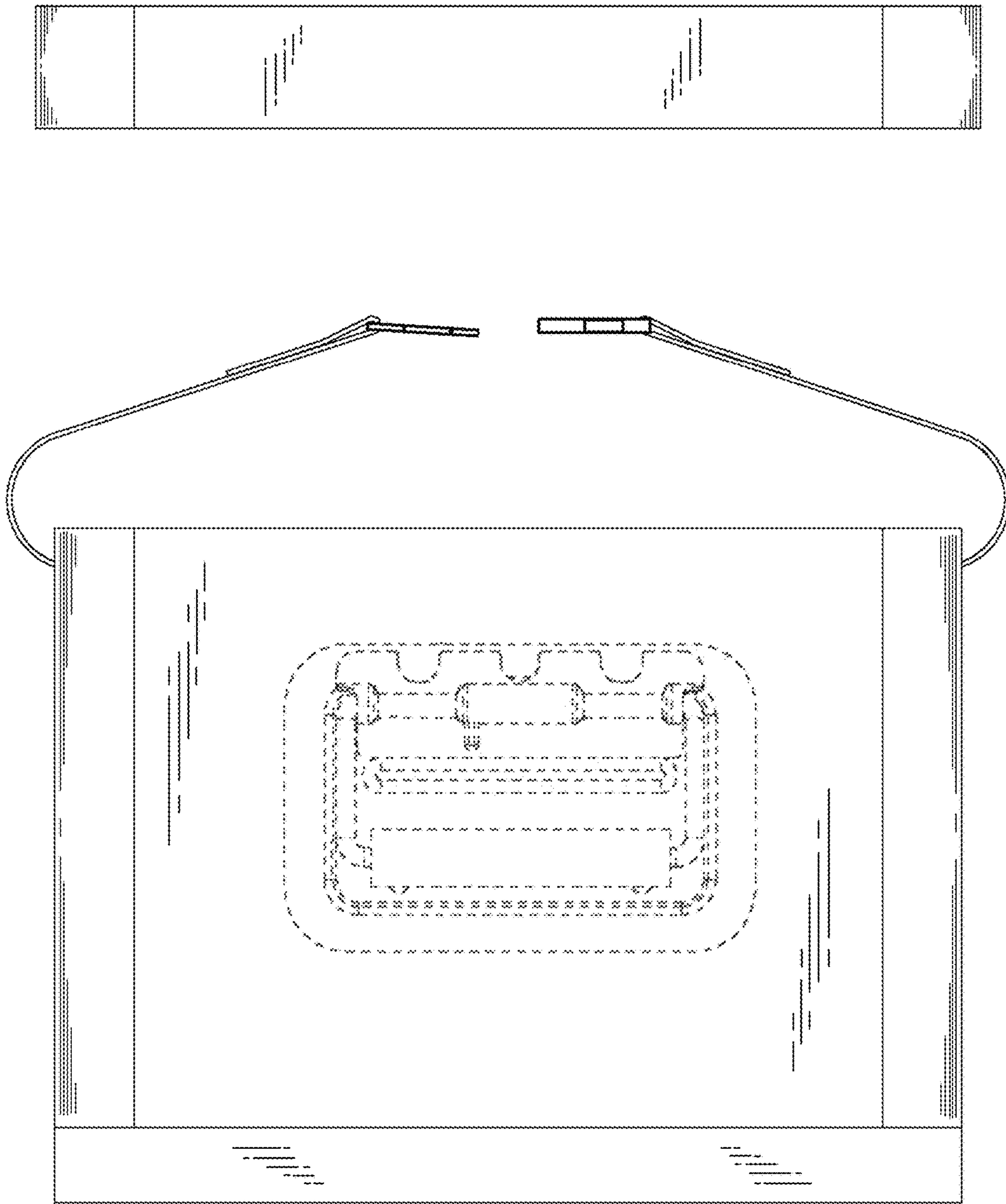

FIG. 3

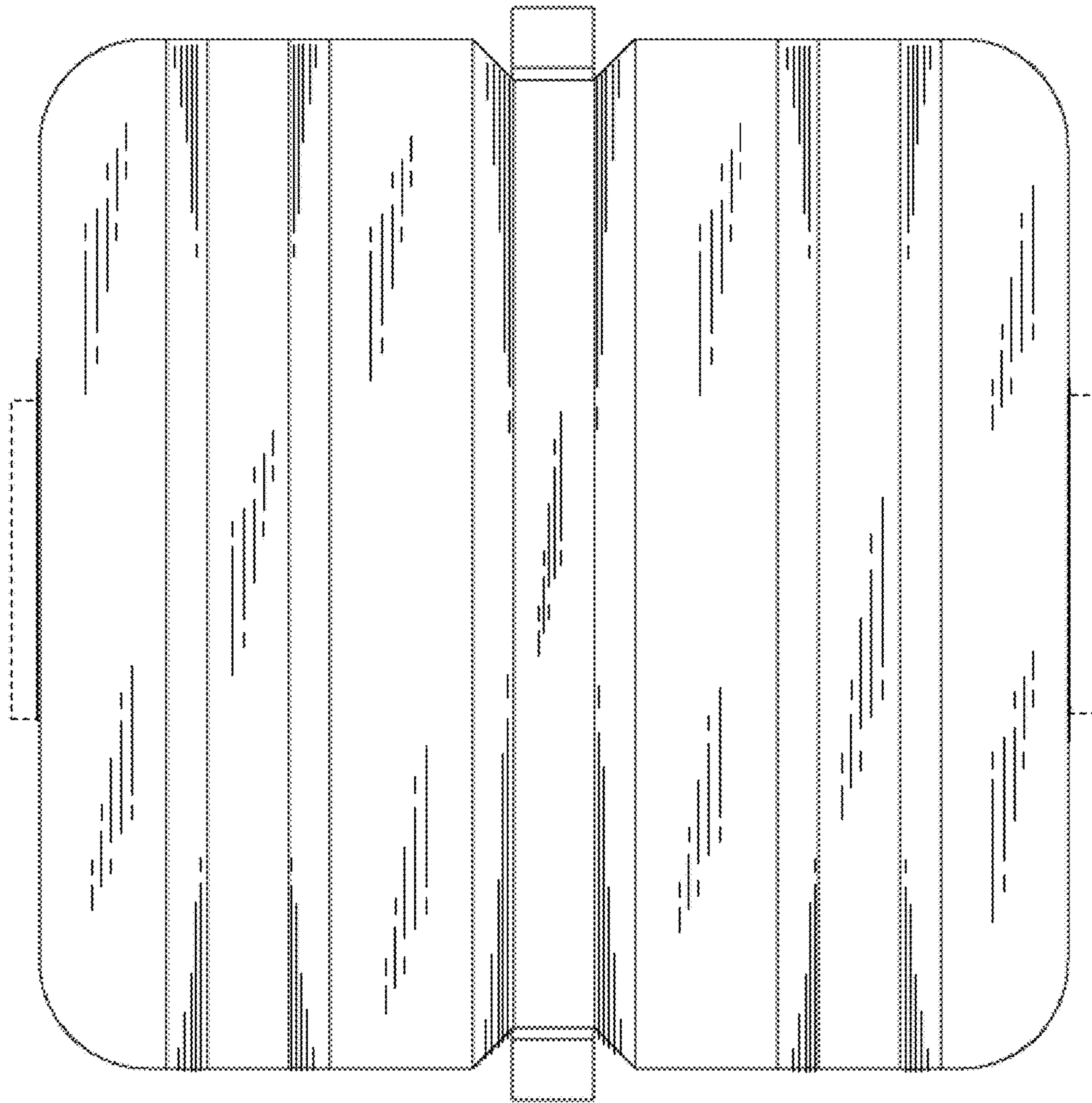

FIG. 4

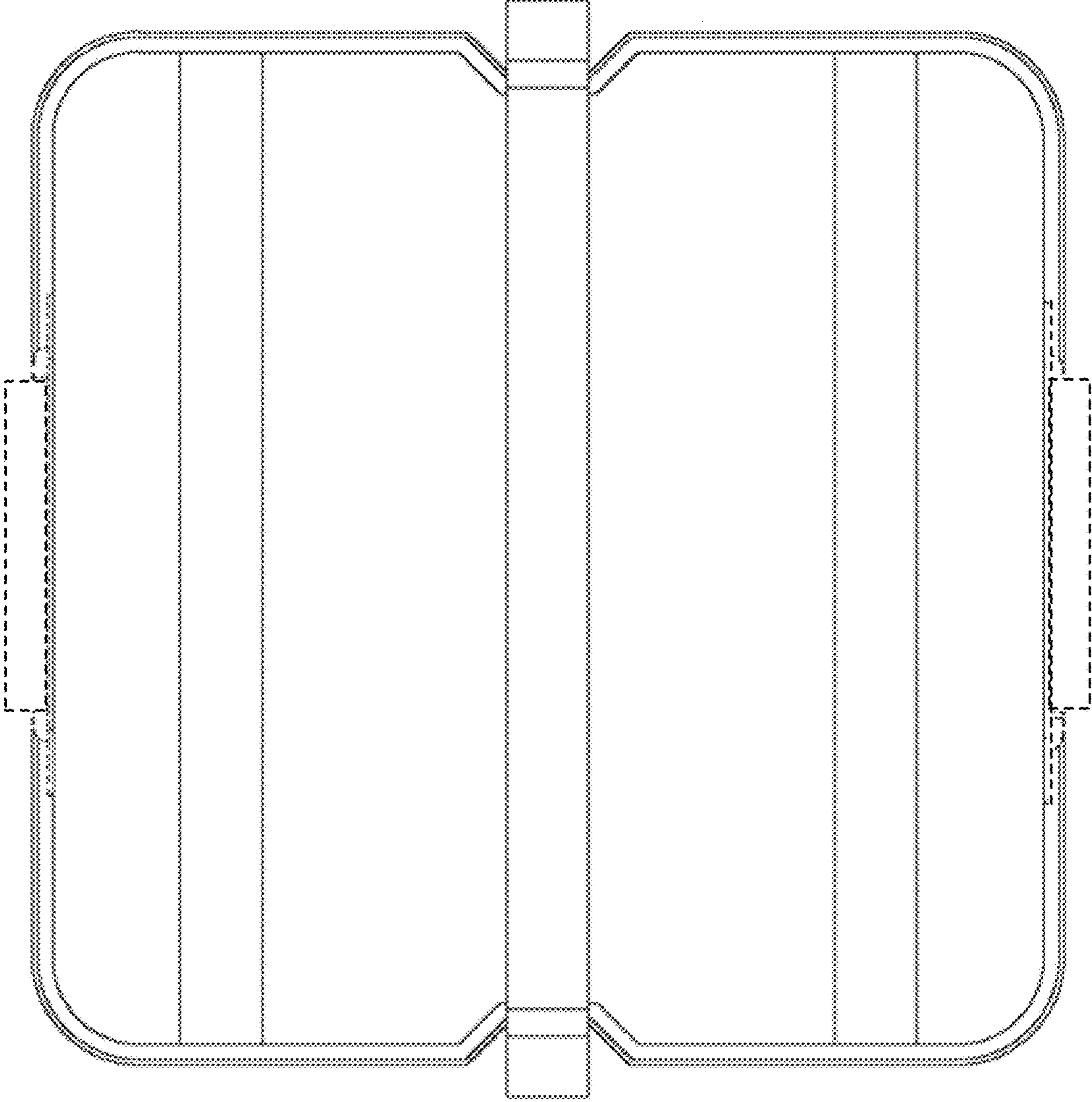

FIG. 5