



US00D812358S

(12) **United States Design Patent**
Garcia et al.

(10) **Patent No.:** **US D812,358 S**
(45) **Date of Patent:** **** Mar. 13, 2018**

(54) **SET OF SHOE INSERTS**
(71) Applicant: **MATTHEWS RESOURCES, INC.**,
Wilmington, DE (US)
(72) Inventors: **Chelsea Garcia**, Lansing, IL (US);
Ryan Davis, Chicago, IL (US)
(73) Assignee: **Matthews International Corporation**,
Pittsburgh, PA (US)

D282,022 S * 1/1986 Wright 36/8.3
4,991,318 A * 2/1991 Cornell A43B 3/20
36/72 R
D345,449 S * 3/1994 Armstrong D2/913
5,809,666 A * 9/1998 Harwood A43B 23/087
36/72 R
D420,784 S * 2/2000 Riecken D2/909
D429,878 S * 8/2000 Tsung-Ping D2/979
6,810,603 B1 * 11/2004 Cosentino A43B 5/12
36/8.3
D616,182 S * 5/2010 Nelson D2/909
(Continued)

(**) Term: **15 Years**

Primary Examiner — Elizabeth J Oswecki

(21) Appl. No.: **29/590,660**

(74) *Attorney, Agent, or Firm* — Pepper Hamilton LLP

(22) Filed: **Jan. 12, 2017**

(57) **CLAIM**

(51) **LOC (11) Cl.** **02-04**
(52) **U.S. Cl.**
USPC **D2/961**

The ornamental design for a set of shoe inserts, as shown and described.

(58) **Field of Classification Search**
USPC D2/896, 909, 946, 961, 972, 974, 976
CPC A43B 1/00; A43B 1/10; A43B 1/14; A43B
3/00; A43B 3/16; A43B 3/163; A43B
7/14; A43B 7/1405; A43B 7/141; A43B
7/1415; A43B 7/142; A43B 7/143; A43B
7/1445; A43B 7/145; A43B 7/1465; A43B
7/24; A43B 7/32; A43B 17/00; A43B
17/003; A43B 17/006; A43B 17/02; A43B
17/023; A43B 17/14; A43B 17/16; A43B
19/00

DESCRIPTION

See application file for complete search history.

FIG. 1 is a side perspective view of a set of shoe inserts, with a toe section towards the bottom and a vamp section towards the top.
FIG. 2 is a front elevation view thereof, with the toe section on the right and the vamp section on the left.
FIG. 3 is a rear elevation view thereof, with the toe section on the left and the vamp section on the right.
FIG. 4 is a right side elevation view thereof, with the toe section on the right and the vamp section on the left.
FIG. 5 is a left side elevation view thereof, with the toe section on the left and the vamp section on the right.
FIG. 6 is a top plan view thereof, with the toe section at the bottom and the vamp section at the top.
FIG. 7 is a bottom plan view thereof, with the toe section at the top and the vamp section at the bottom; and,
FIG. 8 is a perspective view thereof, shown in a used condition with a shoe shown in broken lines.
The broken lines showing a shoe in FIG. 8 illustrate environmental structure, and form no part of the claimed design.

(56) **References Cited**

U.S. PATENT DOCUMENTS

122,969 A * 1/1872 Sage A43B 7/32
36/72 R
461,492 A * 10/1891 Browning A43B 7/32
36/72 R
3,086,520 A * 4/1963 Scholl A43B 7/142
602/29
3,487,830 A * 1/1970 Pruett A61F 13/043
2/239

1 Claim, 8 Drawing Sheets

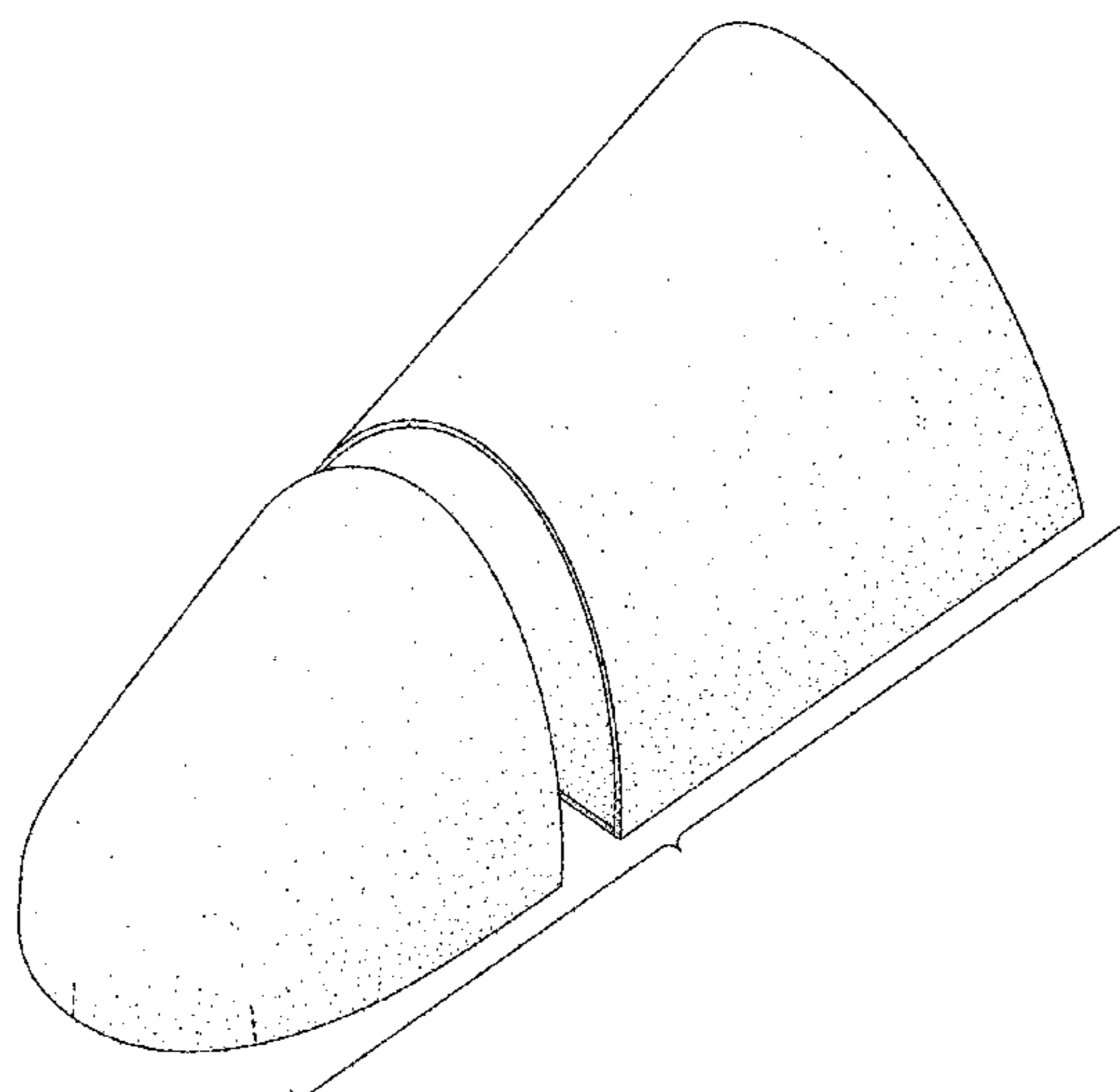

(56)

References Cited

U.S. PATENT DOCUMENTS

7,856,741	B2 *	12/2010	Nguyen	A61F 5/14	
						36/155
7,856,742	B2 *	12/2010	Nguyen	A61F 5/14	
						36/155
D646,472	S *	10/2011	Chen	D2/909	
D646,473	S *	10/2011	Wong	D2/909	
D659,365	S *	5/2012	Huebner	D2/961	
D663,931	S *	7/2012	Allen	D2/961	
8,578,634	B1 *	11/2013	Nguyen	A61F 5/14	
						36/155

* cited by examiner

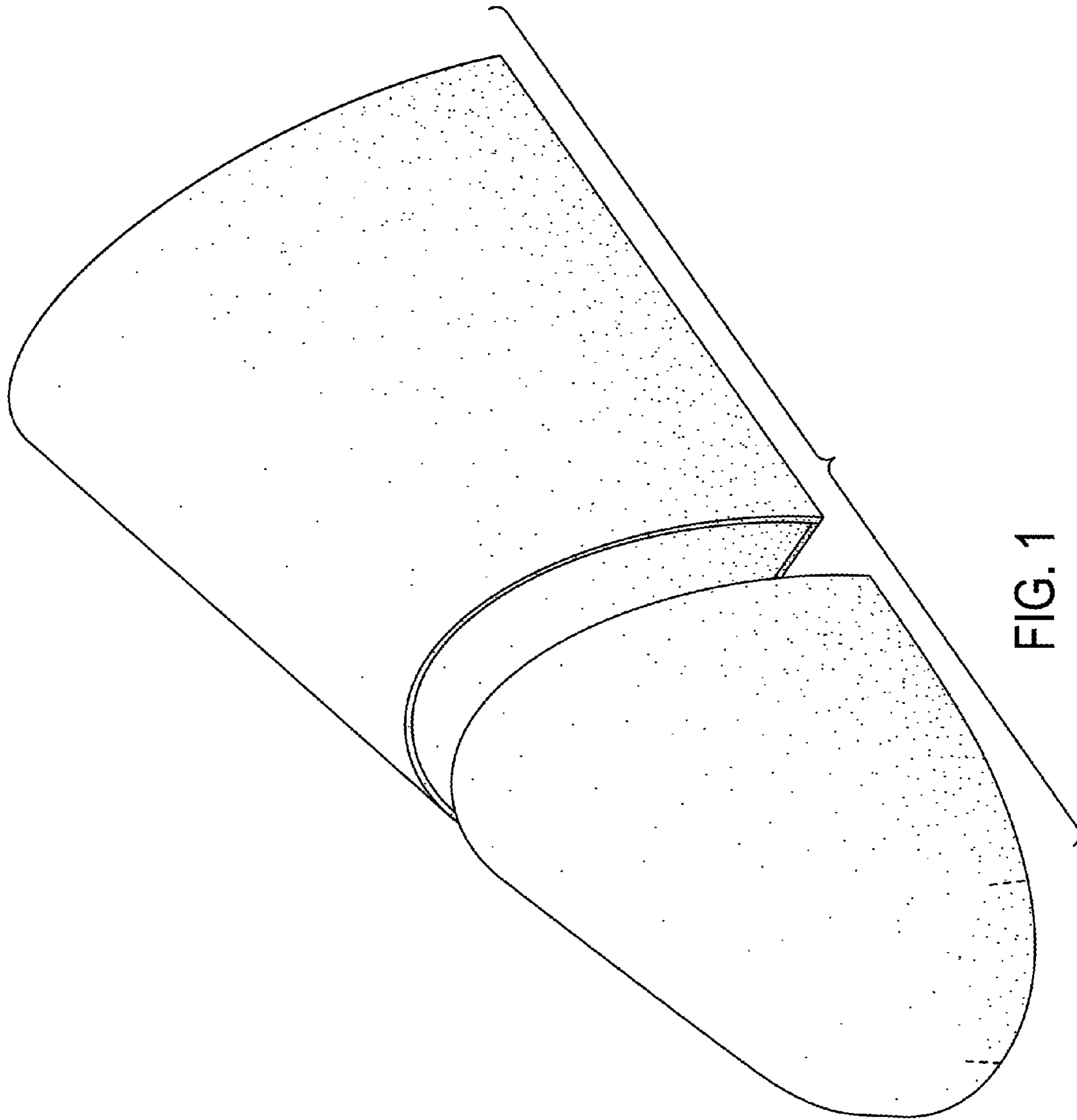

FIG. 1

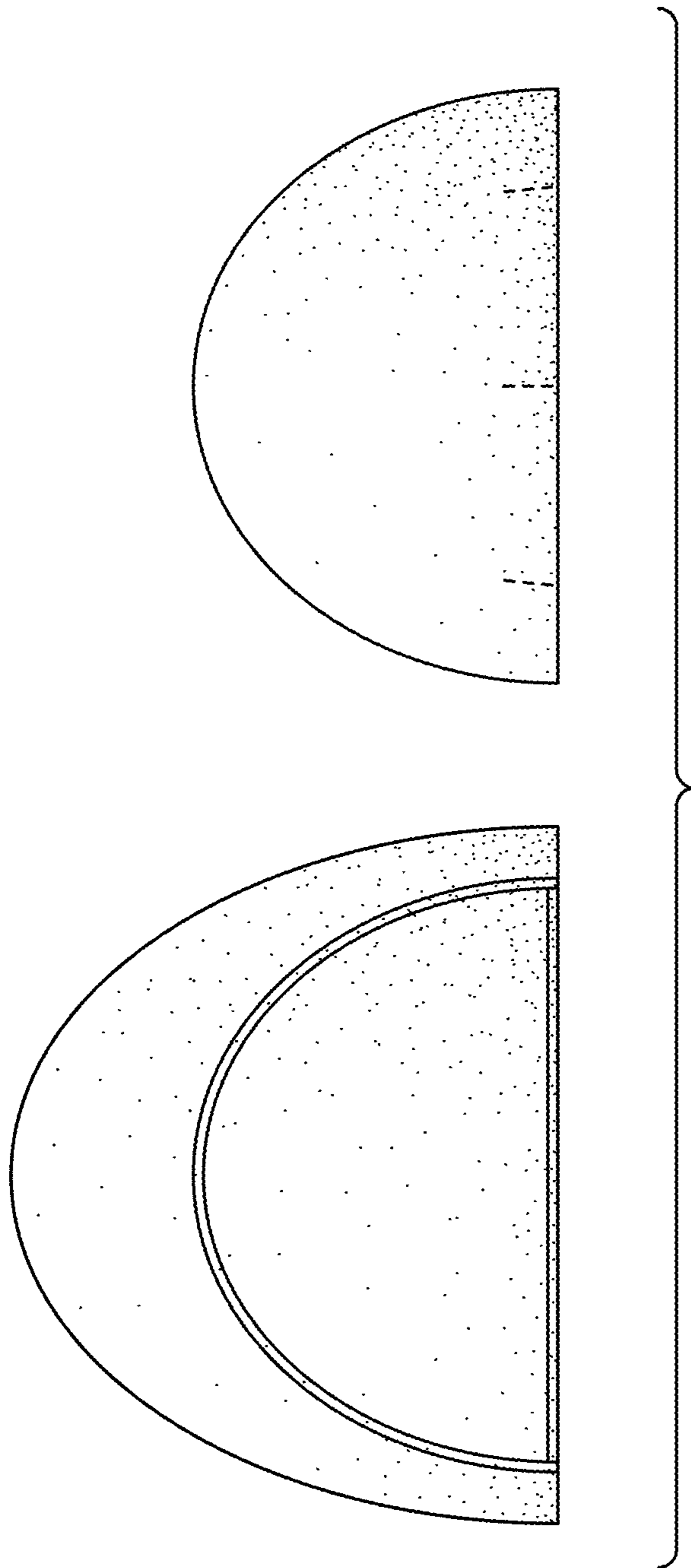

FIG. 2

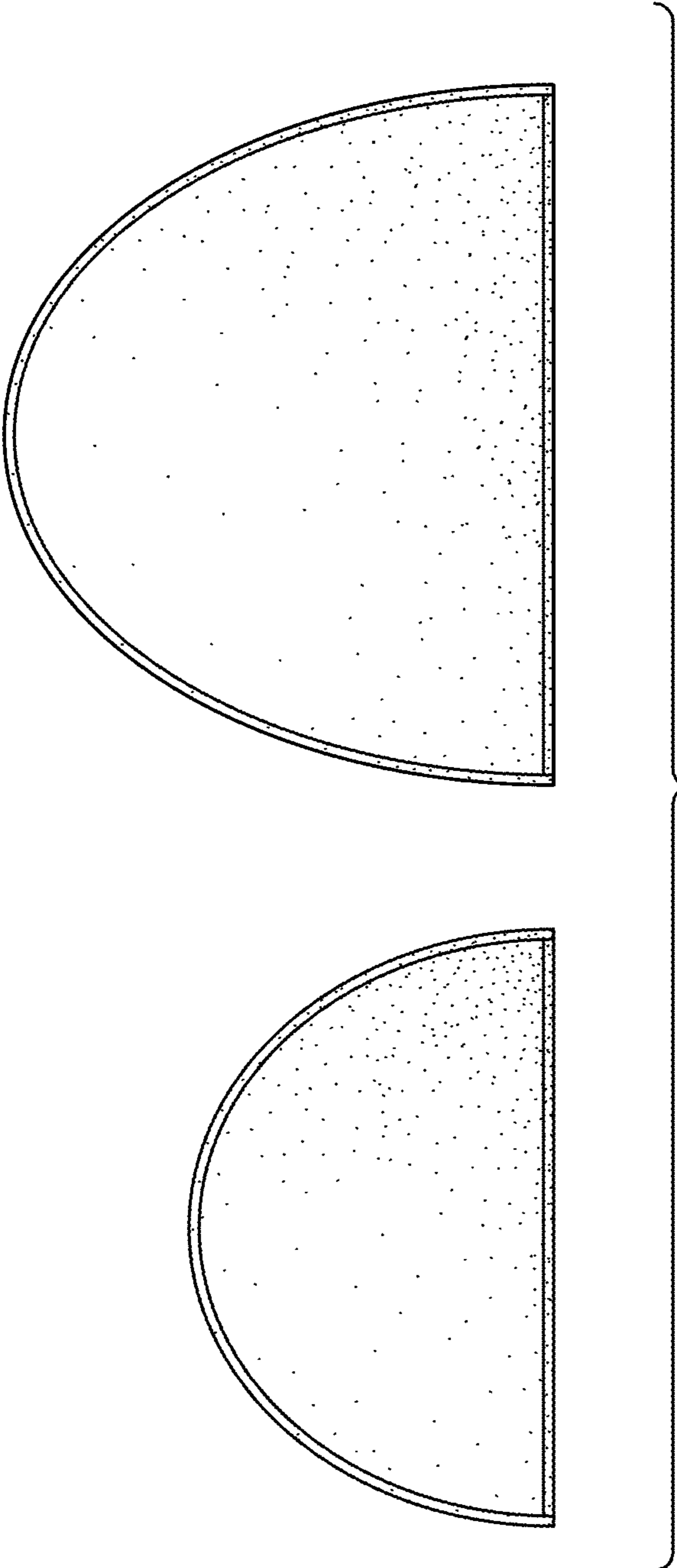

FIG. 3

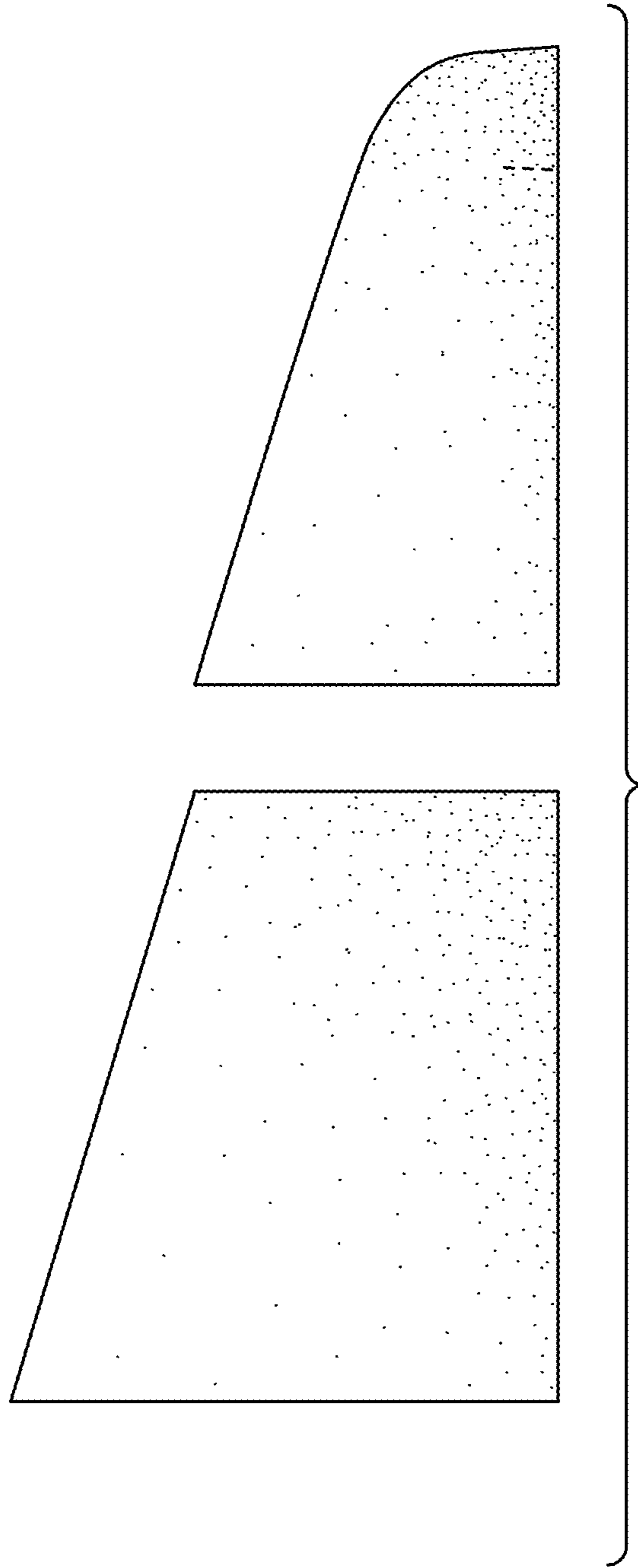

FIG. 4

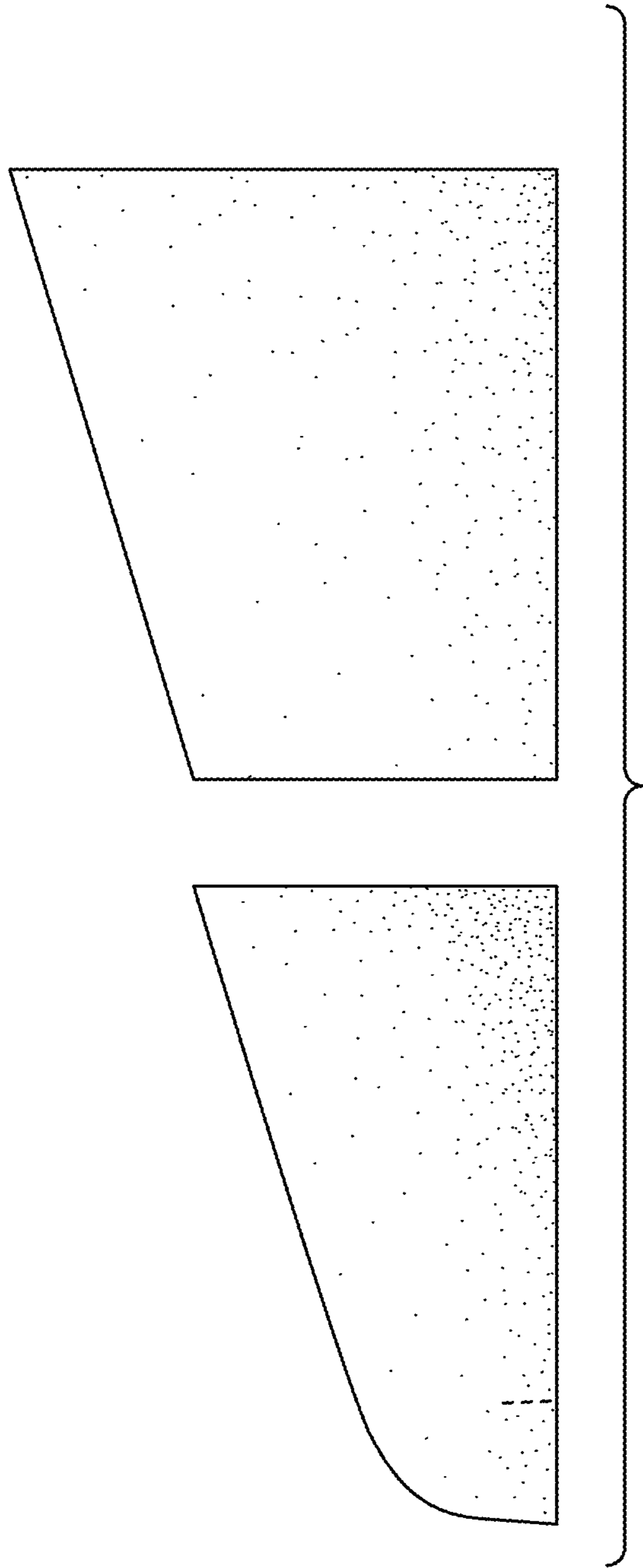

FIG. 5

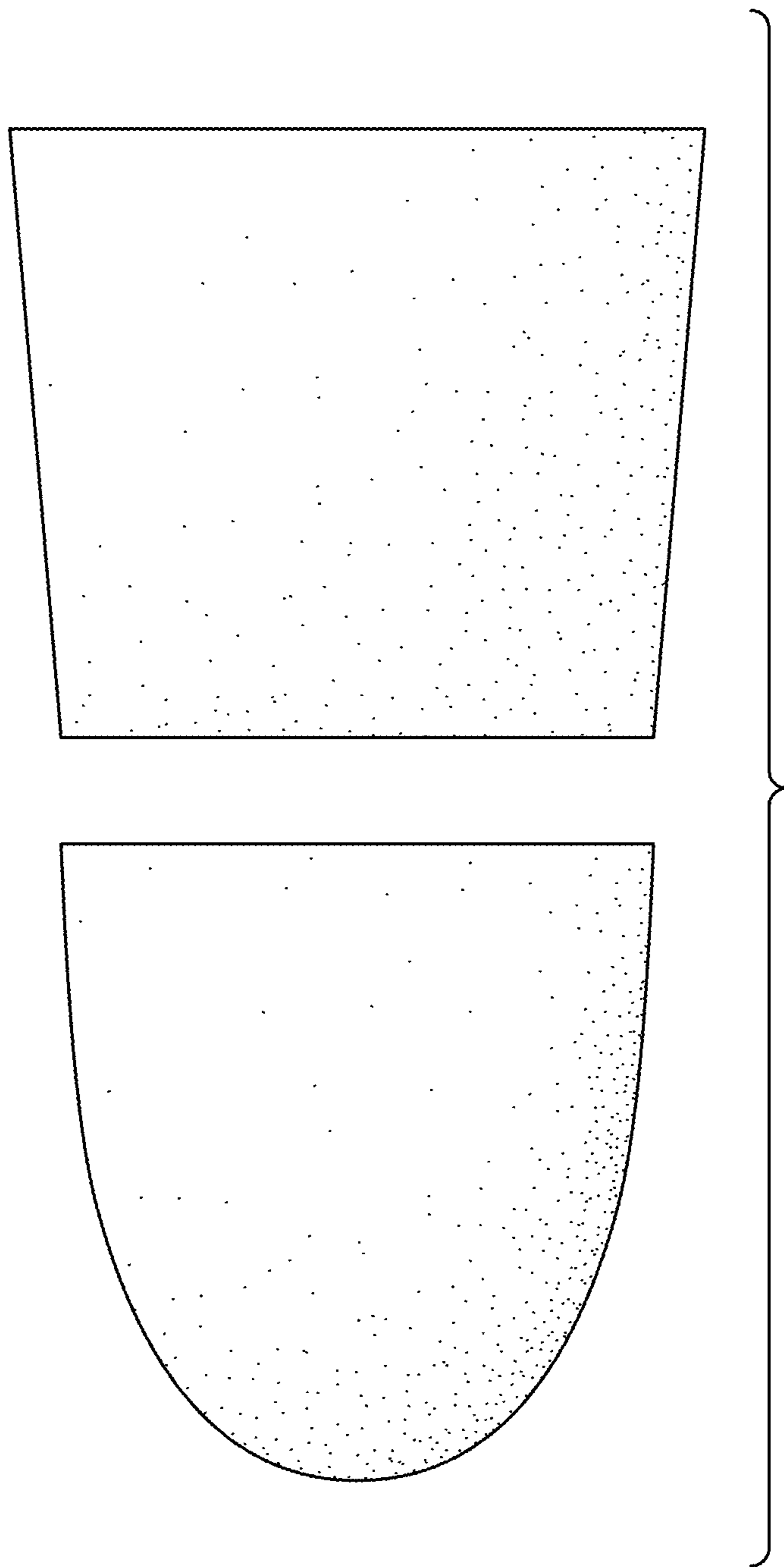

FIG. 6

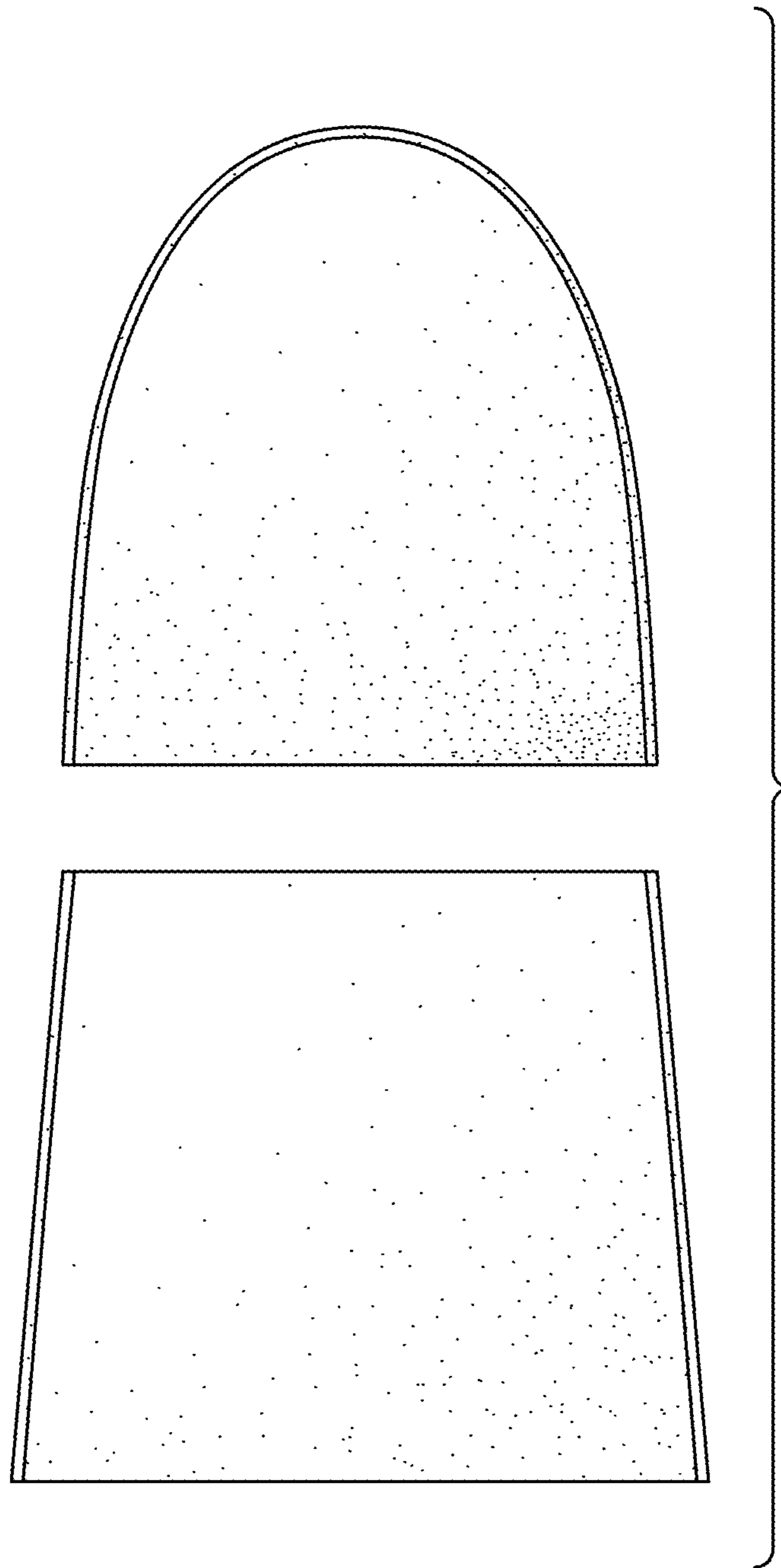

FIG. 7

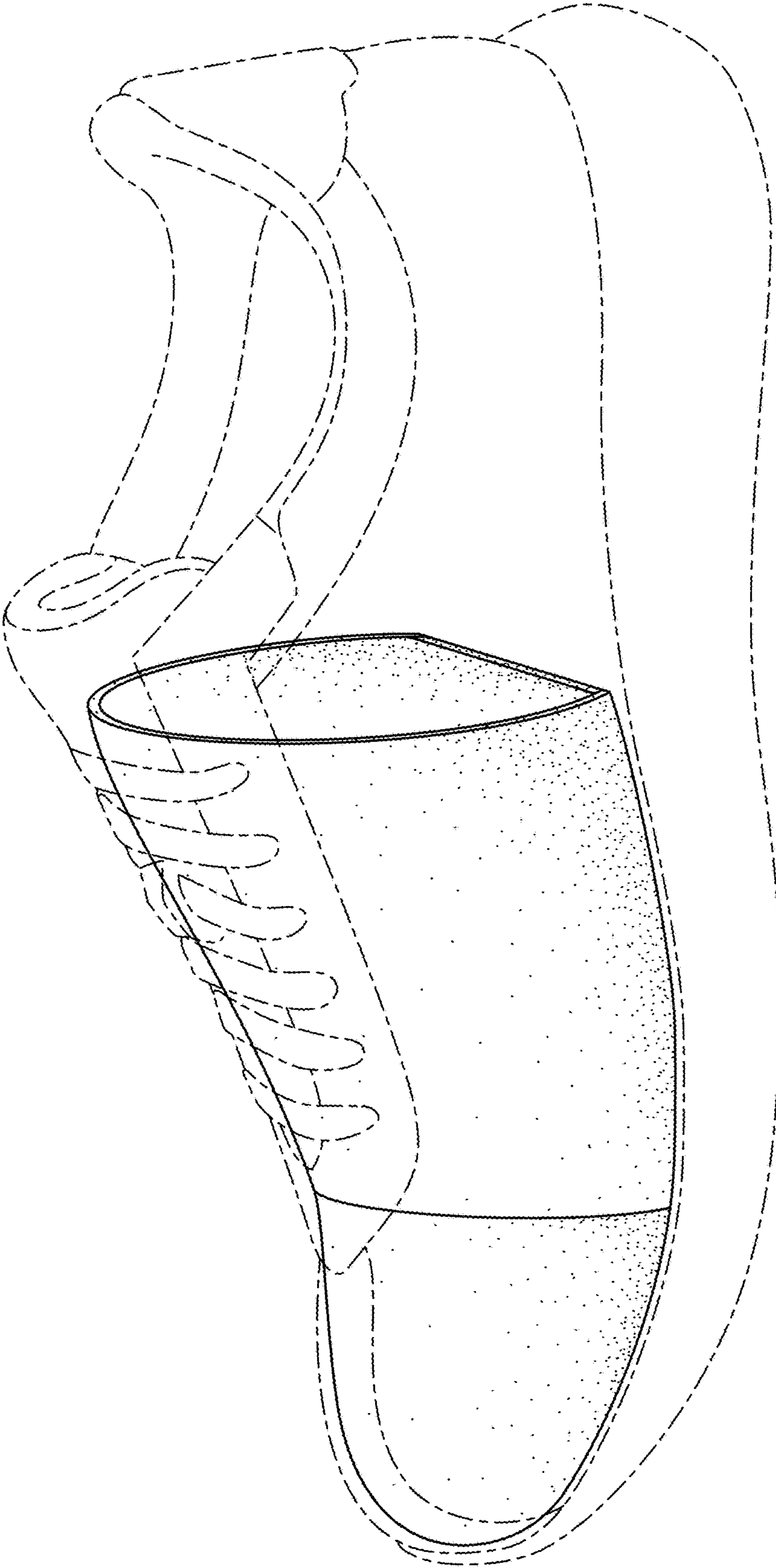

FIG. 8