



US00D812335S

(12) **United States Design Patent** (10) **Patent No.:** **US D812,335 S**
Immerz et al. (45) **Date of Patent:** **** Mar. 6, 2018**

(54) **CONVEYOR BELT**

Primary Examiner — George D Kirschbaum
(74) *Attorney, Agent, or Firm* — Studebaker & Brackett PC

(71) Applicant: **SAVATECH D.O.O.**, Kranj (SI)

(72) Inventors: **Christian Immerz**, Opfenbach (DE);
Marko Rozman, München (DE);
David Pejasinovic, Kranj (SI); **Milan Petkovic**, Dol pri Ljubljani (SI);
Gregor Jerman, Jesenice (SI); **Vinko Tisler**, Duplje (SI)

(57) **CLAIM**

The ornamental design for a conveyor belt, as shown and described.

(73) Assignee: **SAVATECH d.o.o.**, Kranj (SI)

(**) Term: **15 Years**

(21) Appl. No.: **35/501,353**

(22) Filed: **Feb. 22, 2016**

(80) **Hague Agreement Data**

Int. Filing Date: **Feb. 22, 2016**
Int. Reg. No.: **DM/091819**
Int. Reg. Date: **Feb. 22, 2016**
Int. Reg. Pub. Date: **Aug. 5, 2016**

(51) **LOC (11) Cl.** **12-05**

(52) **U.S. Cl.**
USPC **D34/29**

(58) **Field of Classification Search**
USPC D12/533, 534, 537, 535, 539, 544;
D34/29
CPC B65G 15/02; B65G 17/066; B65G 17/02;
B65G 15/10
See application file for complete search history.

(56) **References Cited**

U.S. PATENT DOCUMENTS

D52,962 S * 2/1919 Pashek D12/537
D63,840 S * 1/1924 Bean D12/537
3,545,598 A * 12/1970 McGinnis B65G 15/02
198/821
4,422,544 A * 12/1983 Alldredge B65G 17/066
198/838

DESCRIPTION

- 1.-3. Conveyor belts
- 1.1 : Top
- 1.2 : Left
- 1.3 : Cross-sectional
- 1.4 : Front
- 1.5 : Enlarged front view of middle ribs
- 1.6 : Enlarged side view of a lower end of a side rib
- 1.7 : Enlarged front view of a rib
- 1.8 : Enlarged side view of an upper end
- 1.9 : Enlarged cross-sectional view of a rib
- 1.10 : Enlarged cross-sectional view of middle ribs
- 2.1 : Top
- 2.2 : Left
- 2.3 : Front
- 2.4 : Cross-sectional
- 2.5 : Enlarged front view of middle ribs
- 2.6 : Enlarged front view of a rib
- 2.7 : Enlarged side view of a lower end of a side rib
- 2.8 : Enlarged side view of an upper end of a side rib
- 2.9 : Enlarged cross-sectional view of a rib
- 2.10 : Enlarged cross-sectional view of middle ribs
- 3.1: Top
- 3.2: Left
- 3.3: Front
- 3.4: Cross-section
- 3.5: Enlarged front view of rib
- 3.6: Enlarged side view of a upper end of a side rib
- 3.7: Enlarged front view of middle ribs
- 3.8: Enlarged side view of a lower end of a side rib
- 3.9: Enlarged cross-sectional view of middle ribs
- 3.10: Enlarged cross-sectional view of a rib

(Continued)

1 Claim, 30 Drawing Sheets

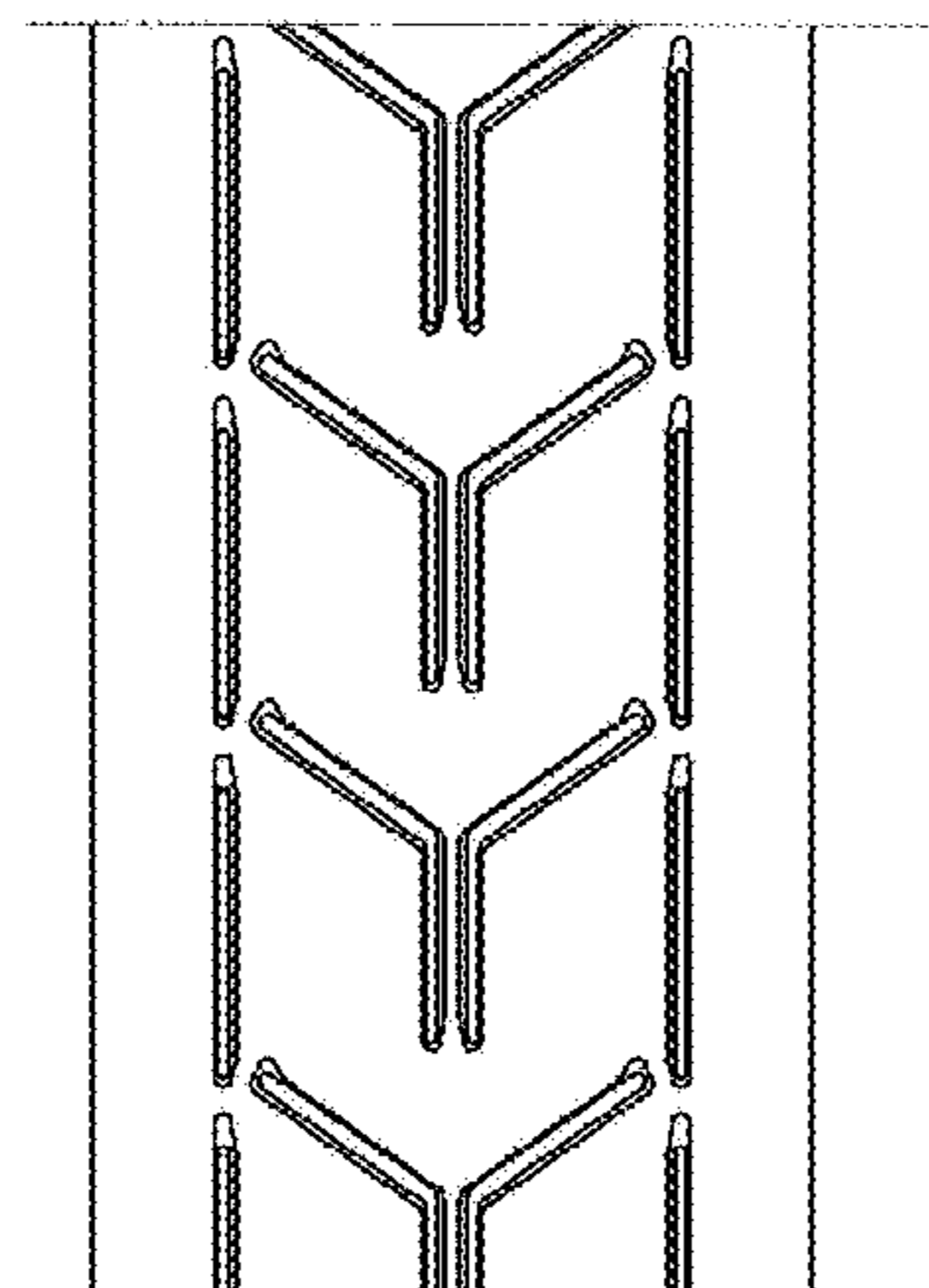

(56)

References Cited

U.S. PATENT DOCUMENTS

4,461,378 A * 7/1984 Roth B65G 17/02
198/370.04
D301,441 S * 6/1989 Matsumura D12/535
D565,500 S * 4/2008 Whitney D12/535
9,340,358 B2 * 5/2016 Finatzer B65G 15/10

* cited by examiner

1.1

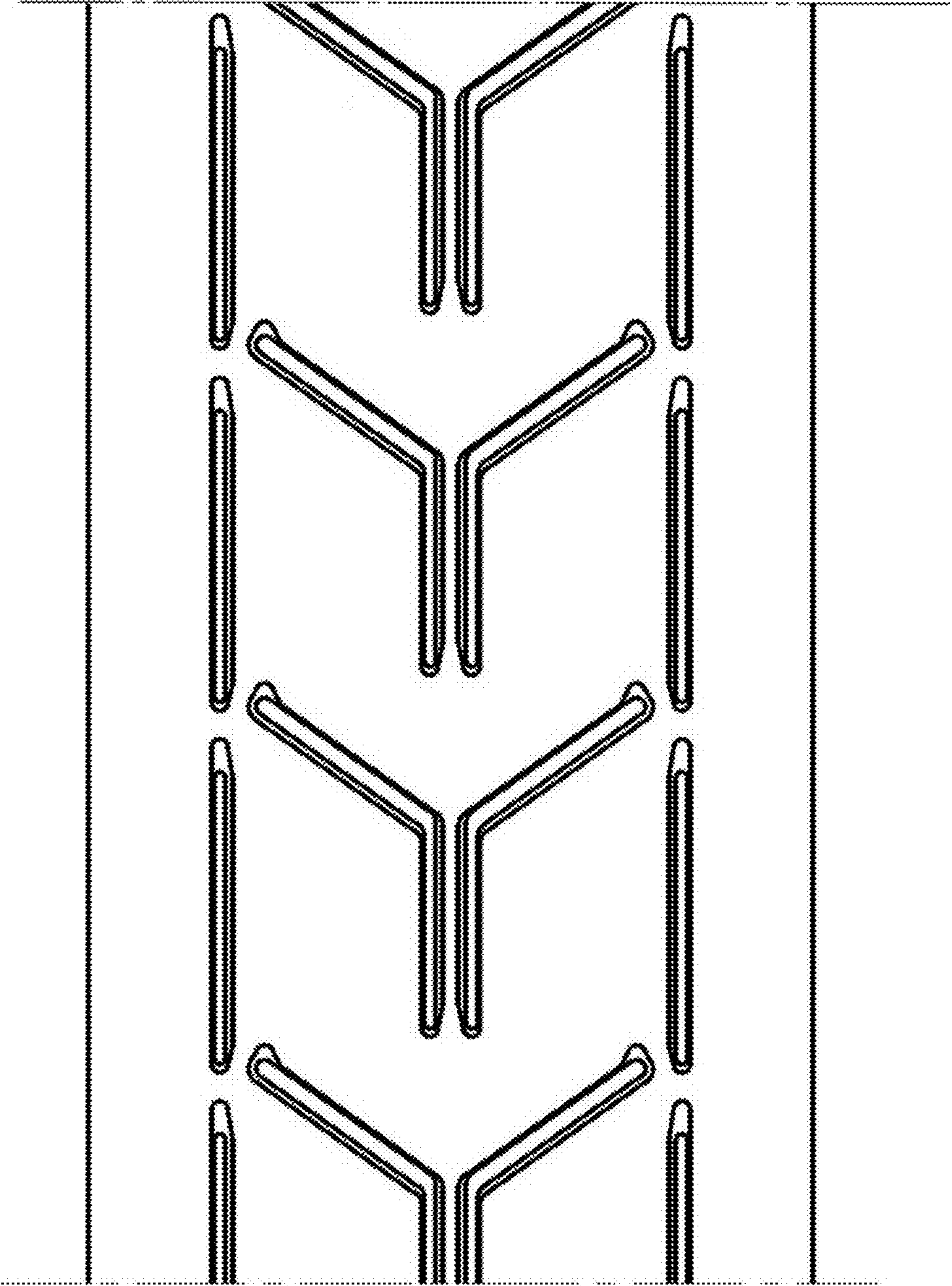

1.2

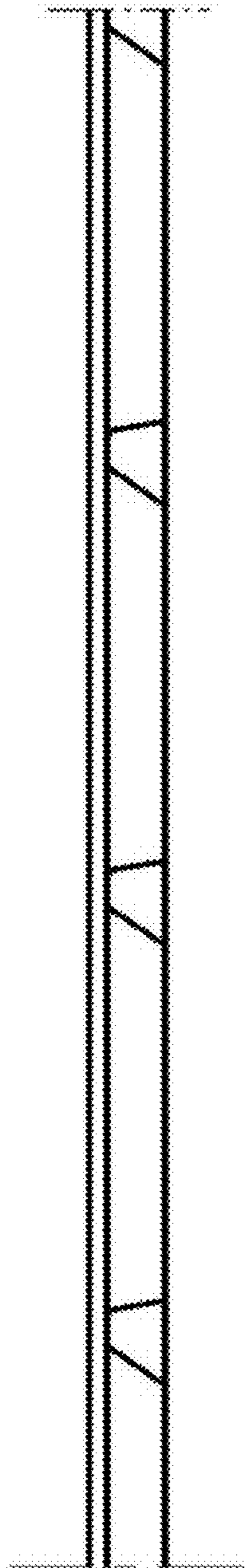

1.3

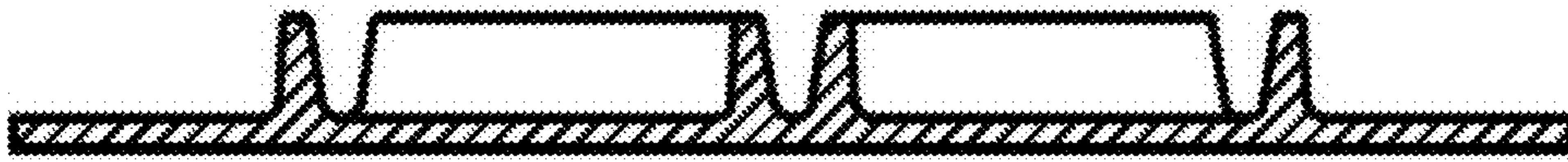

1.4

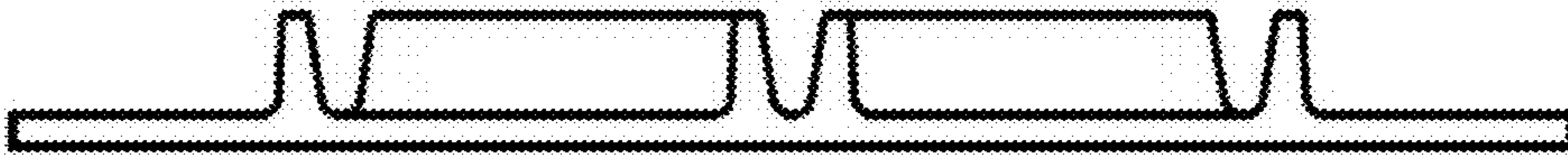

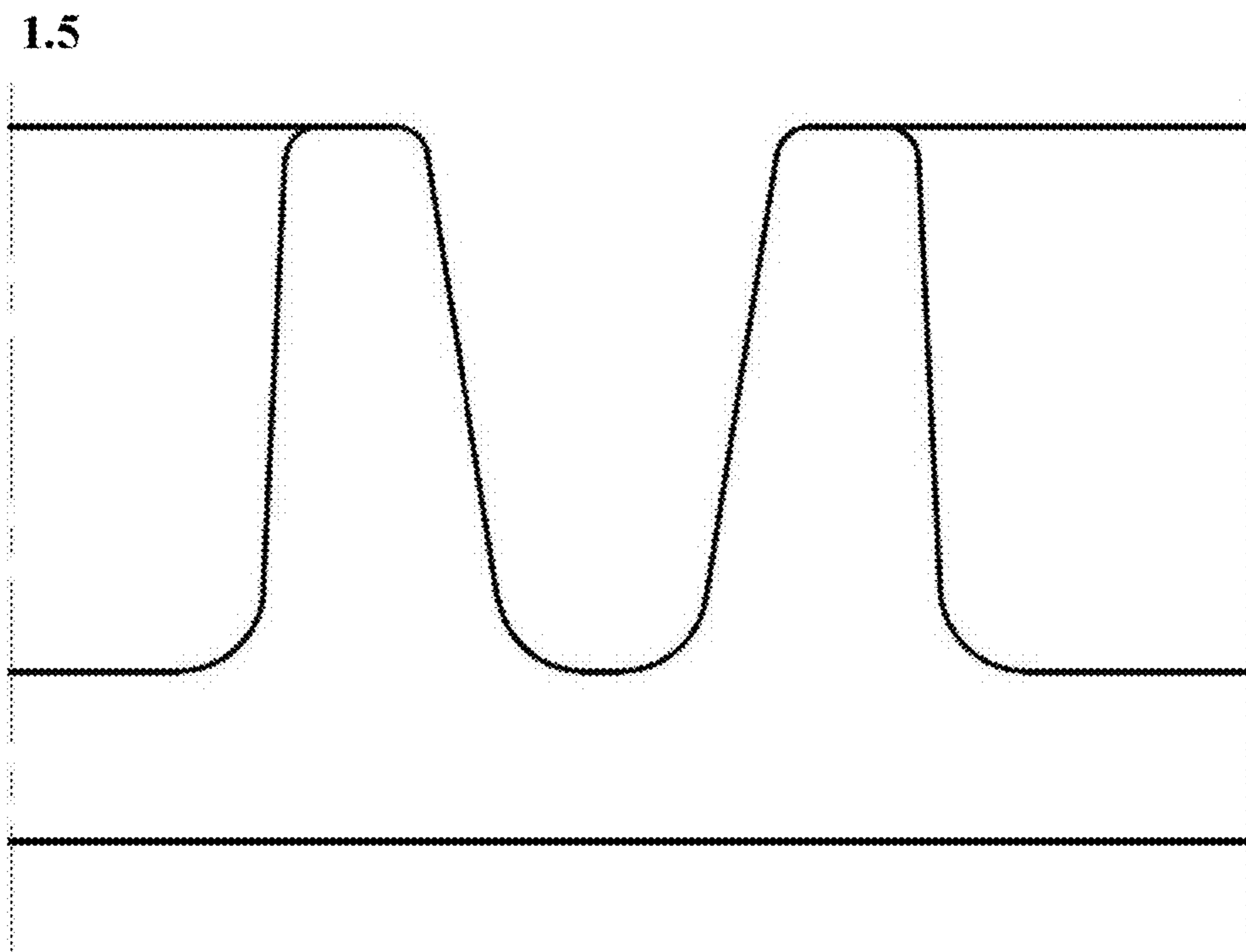

1.6

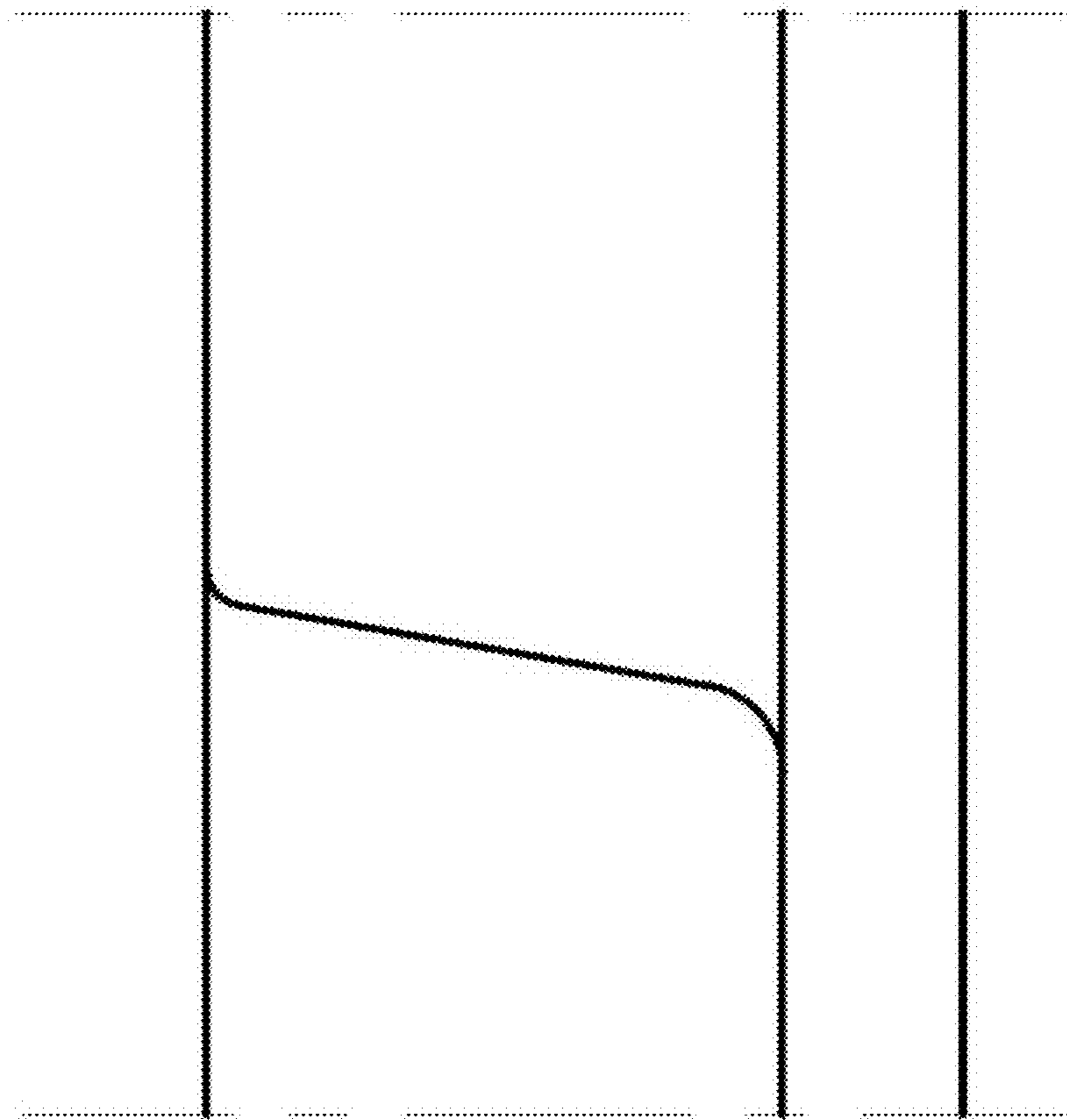

1.7

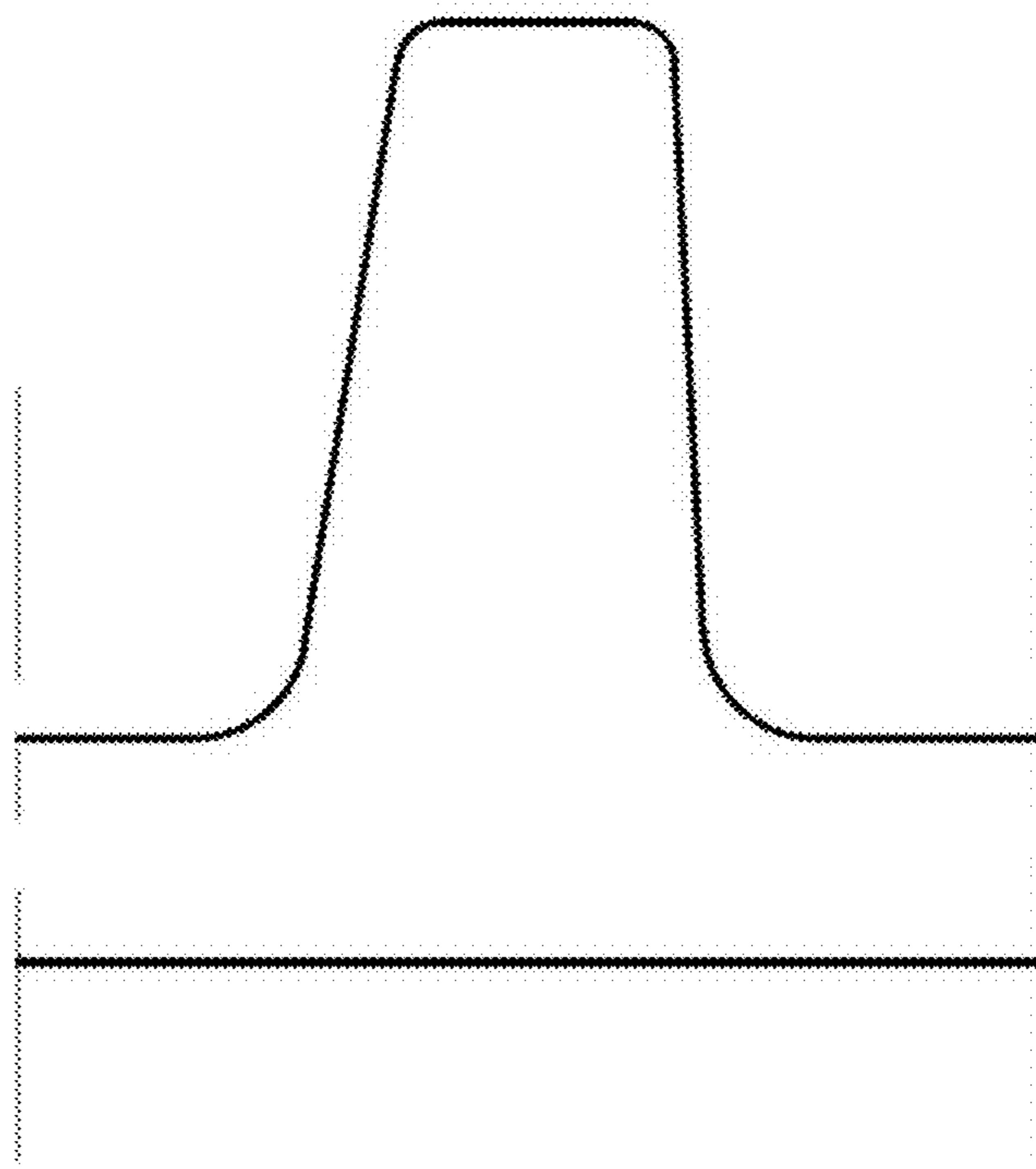

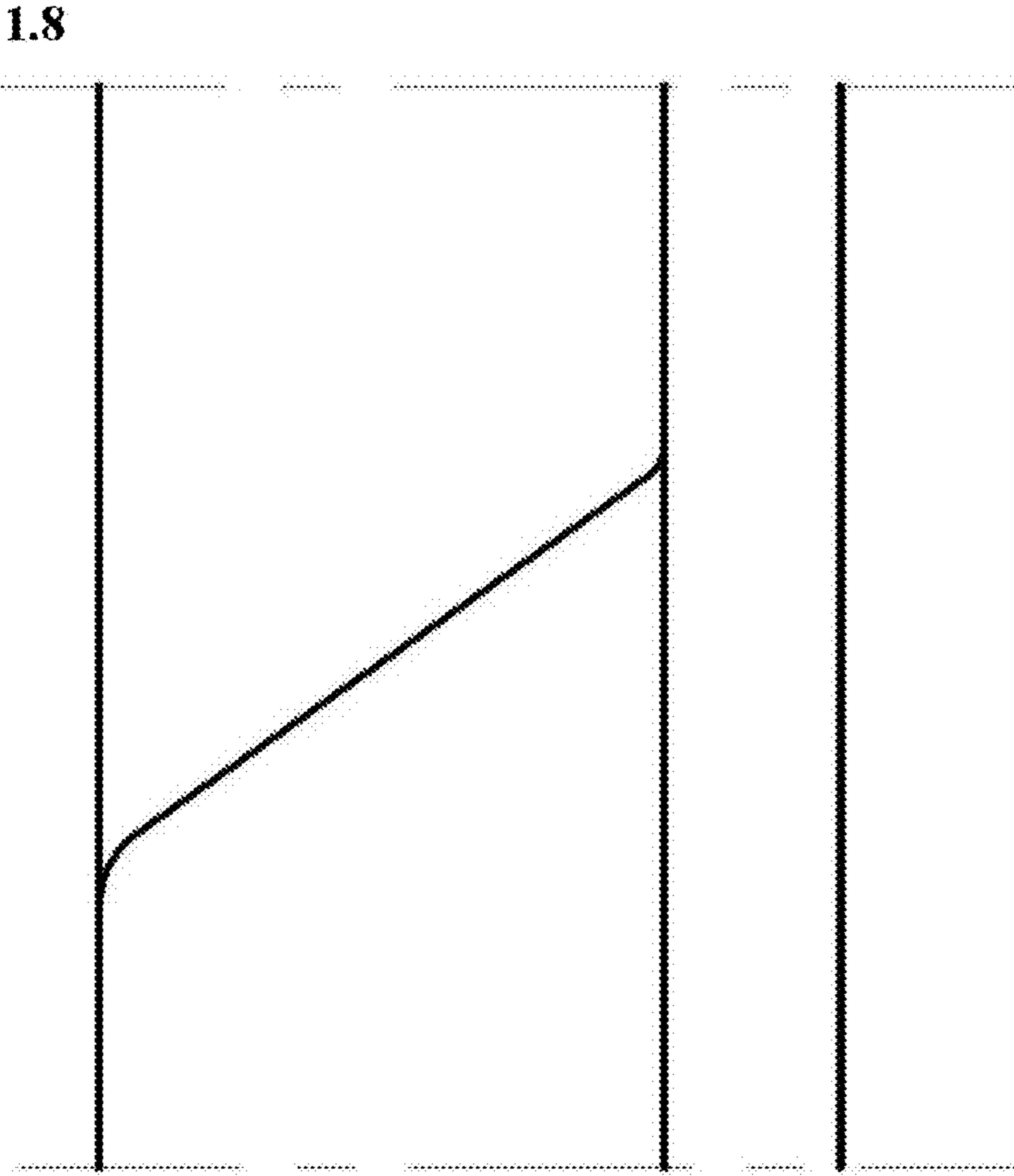

1.9

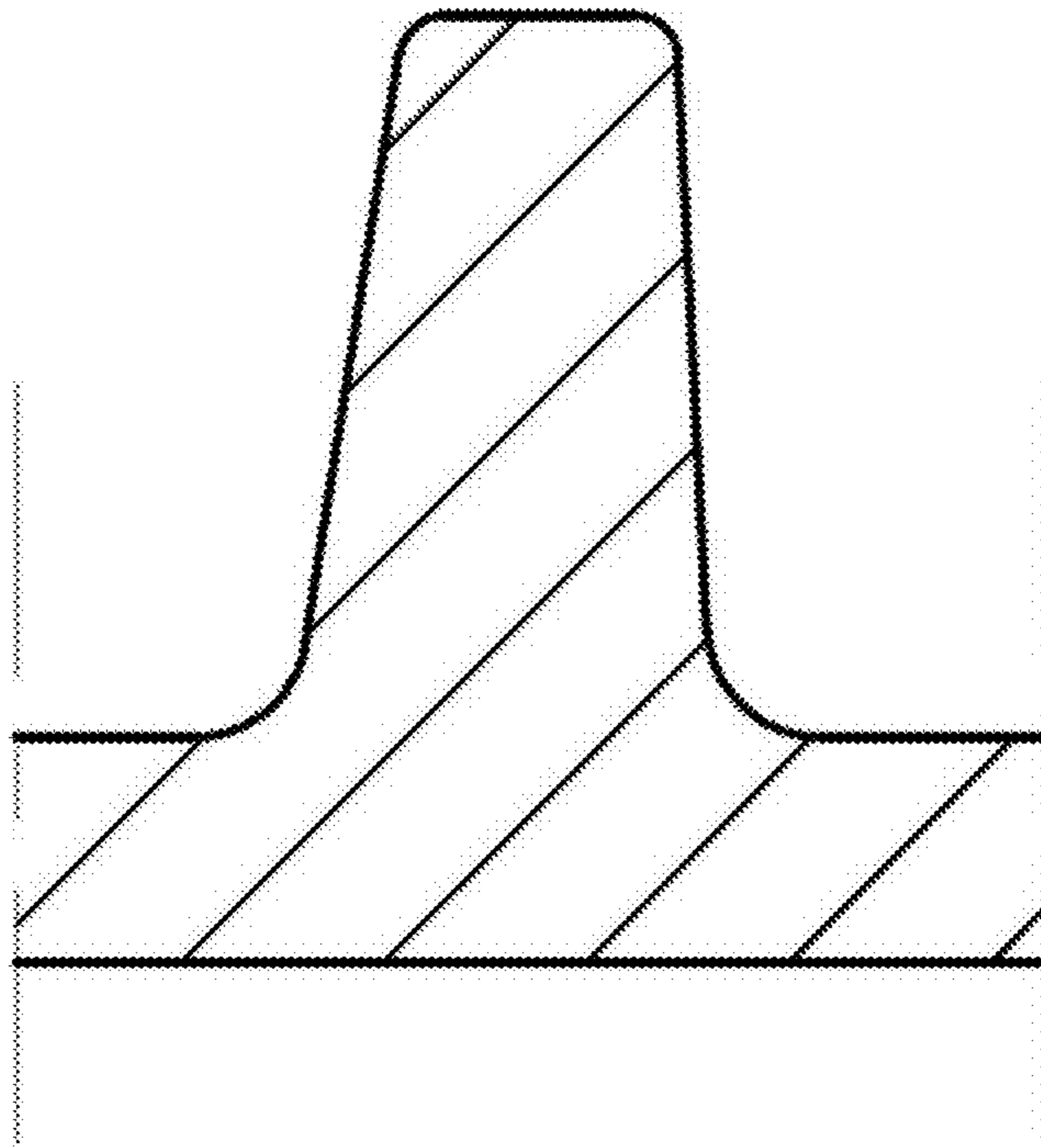

1.10

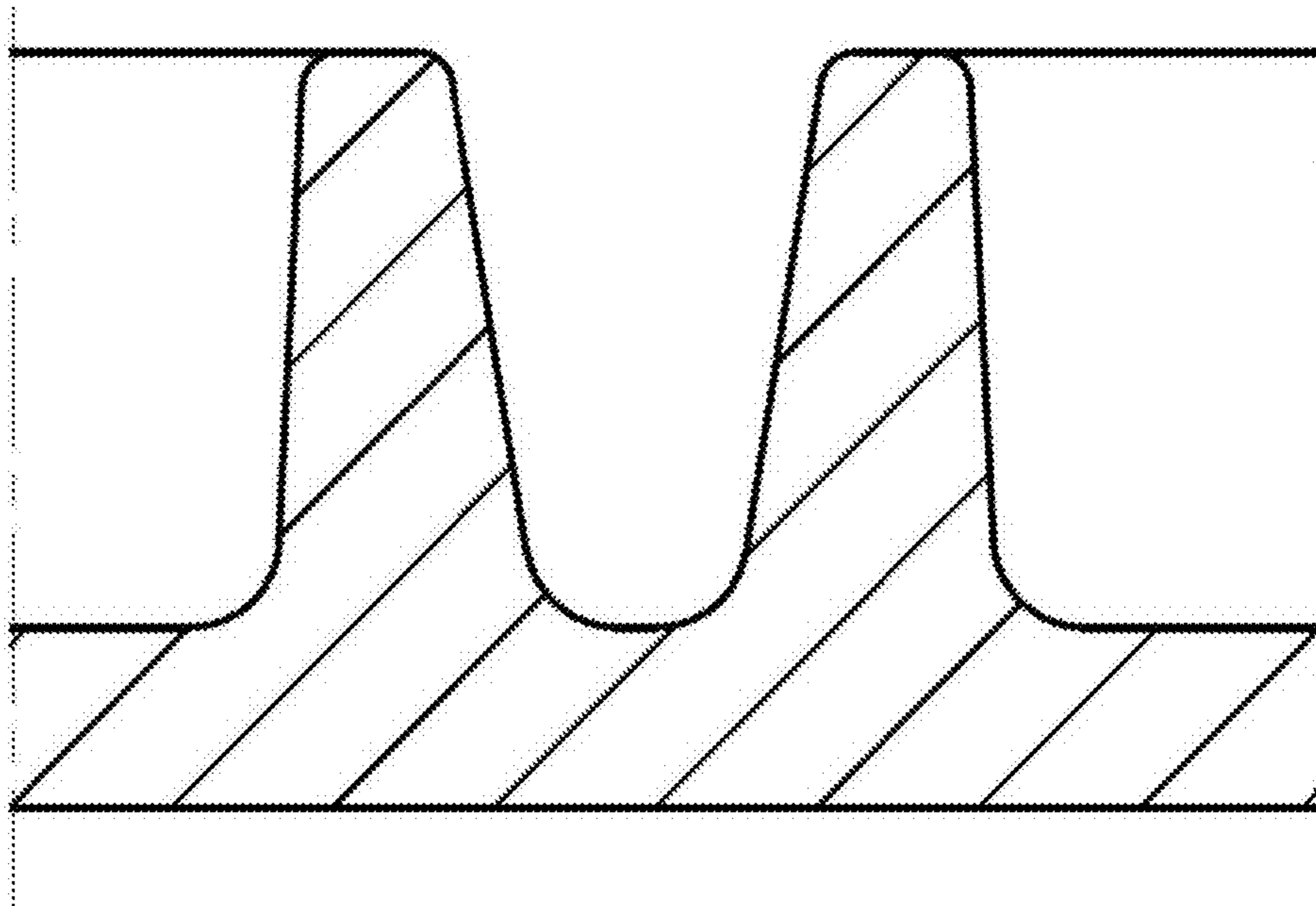

2.1

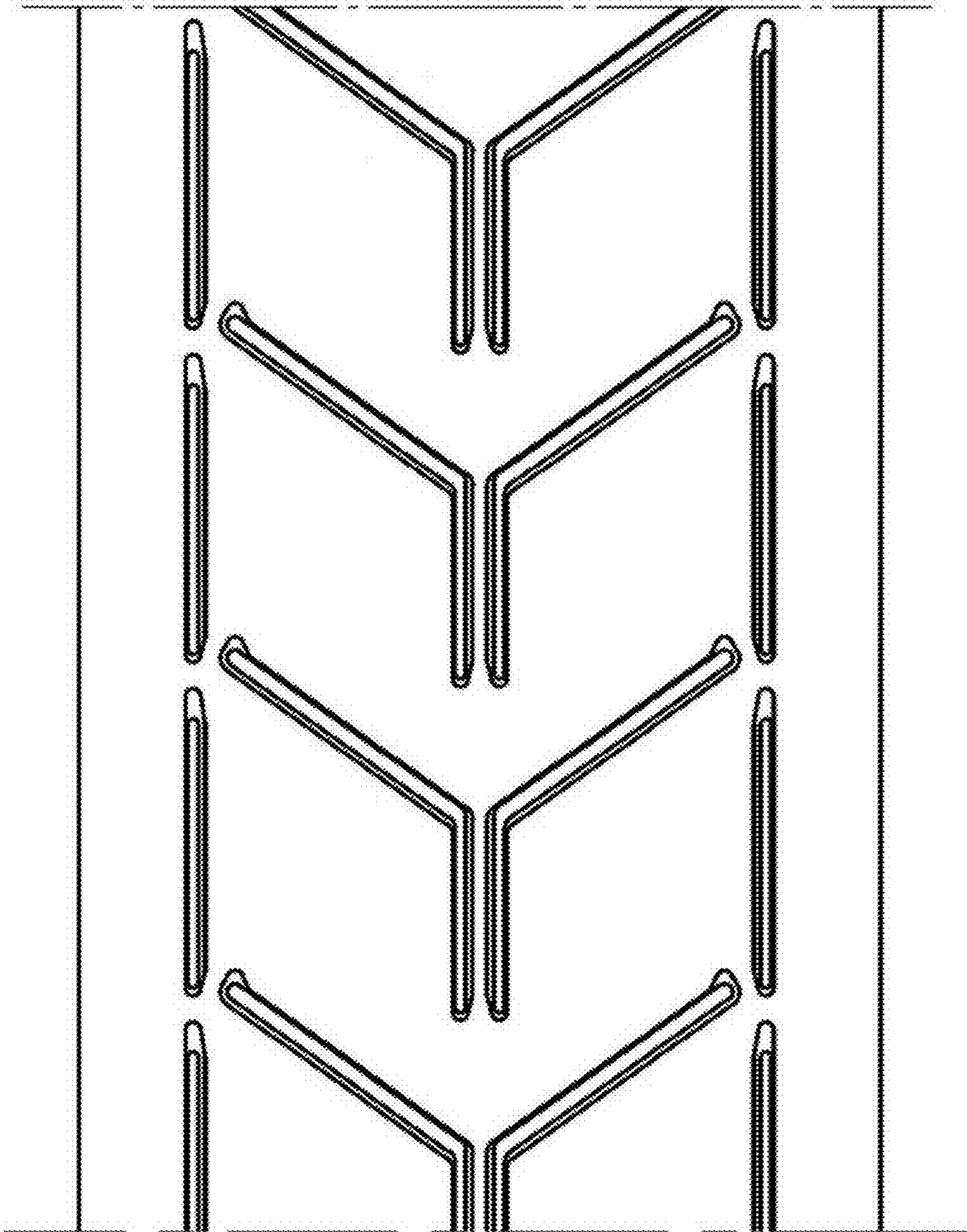

2.2

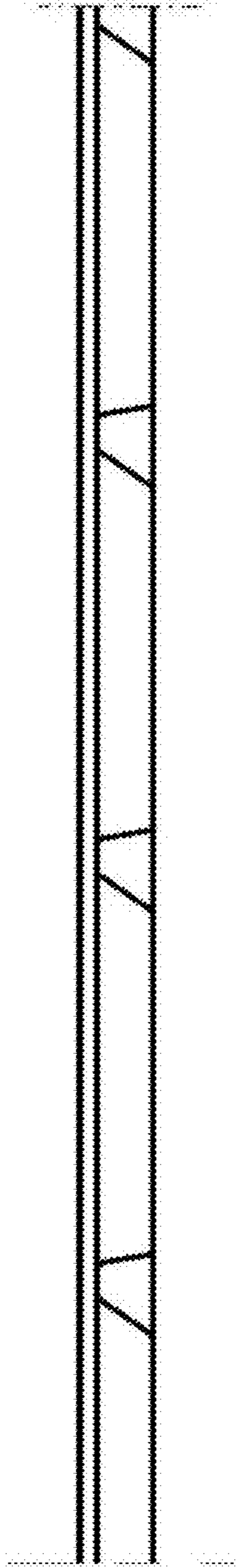

2.3

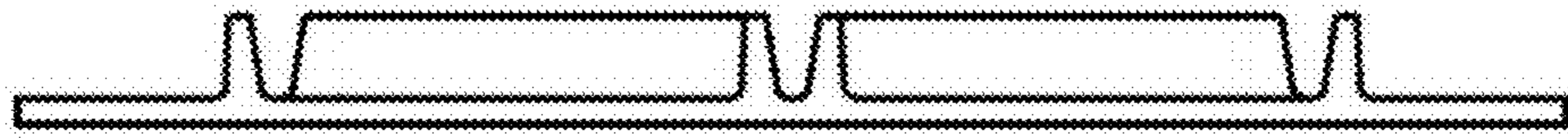

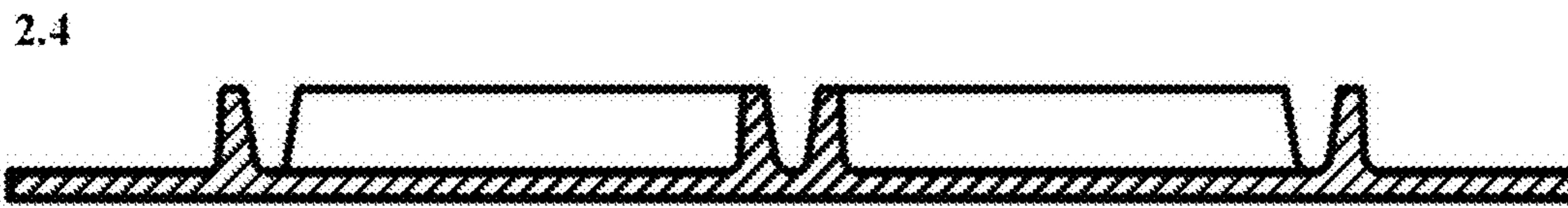

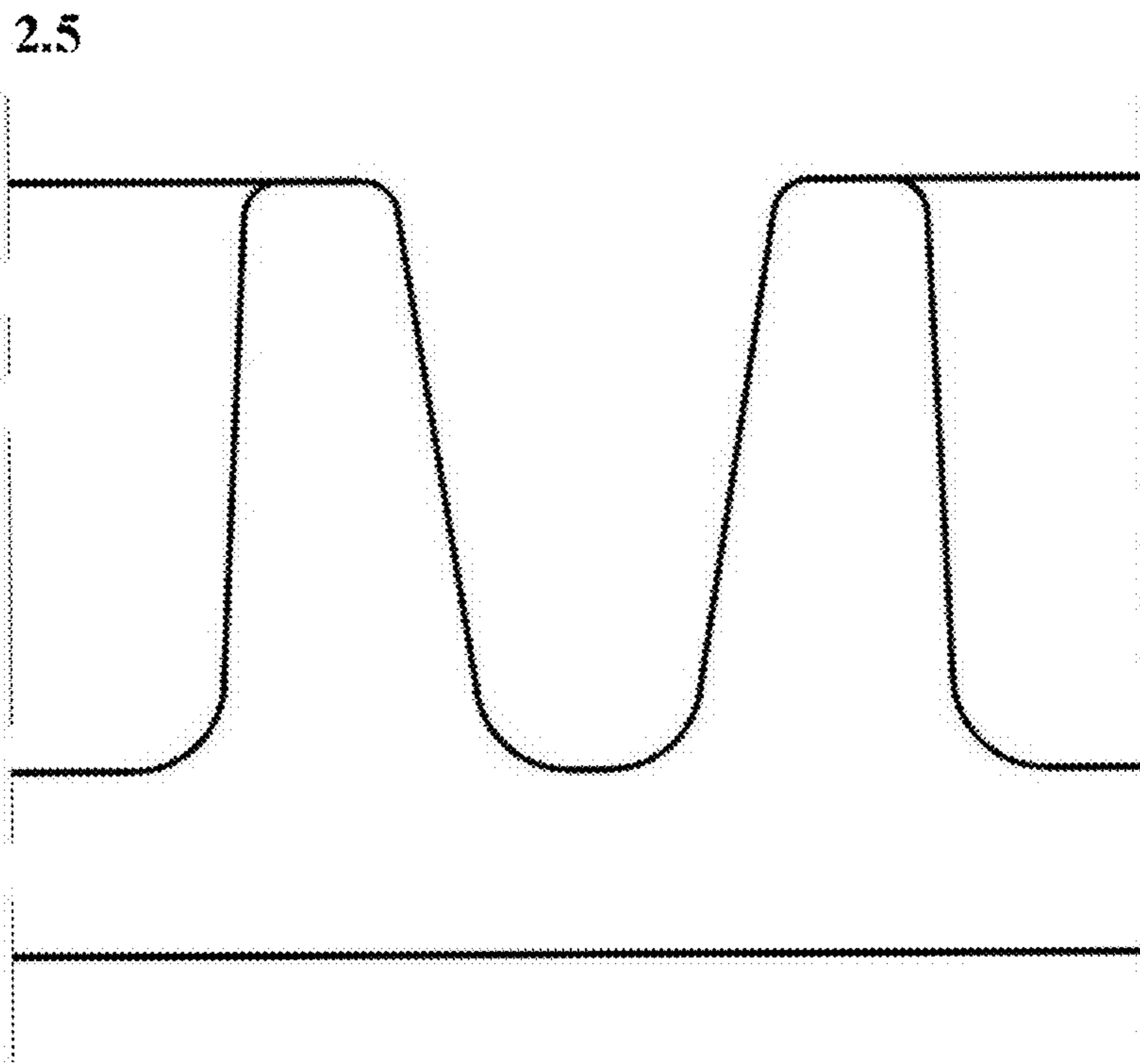

2.6

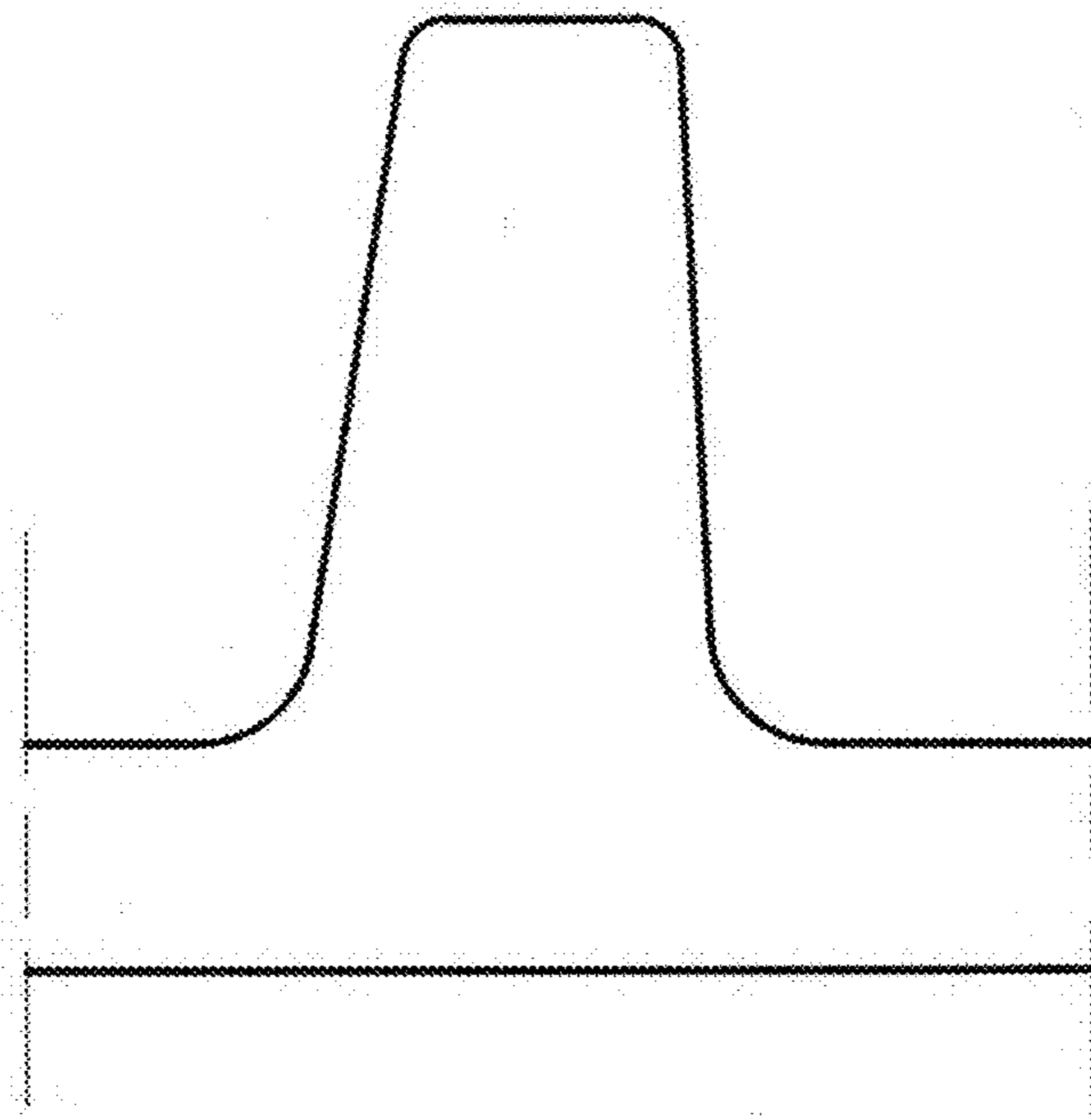

2.7

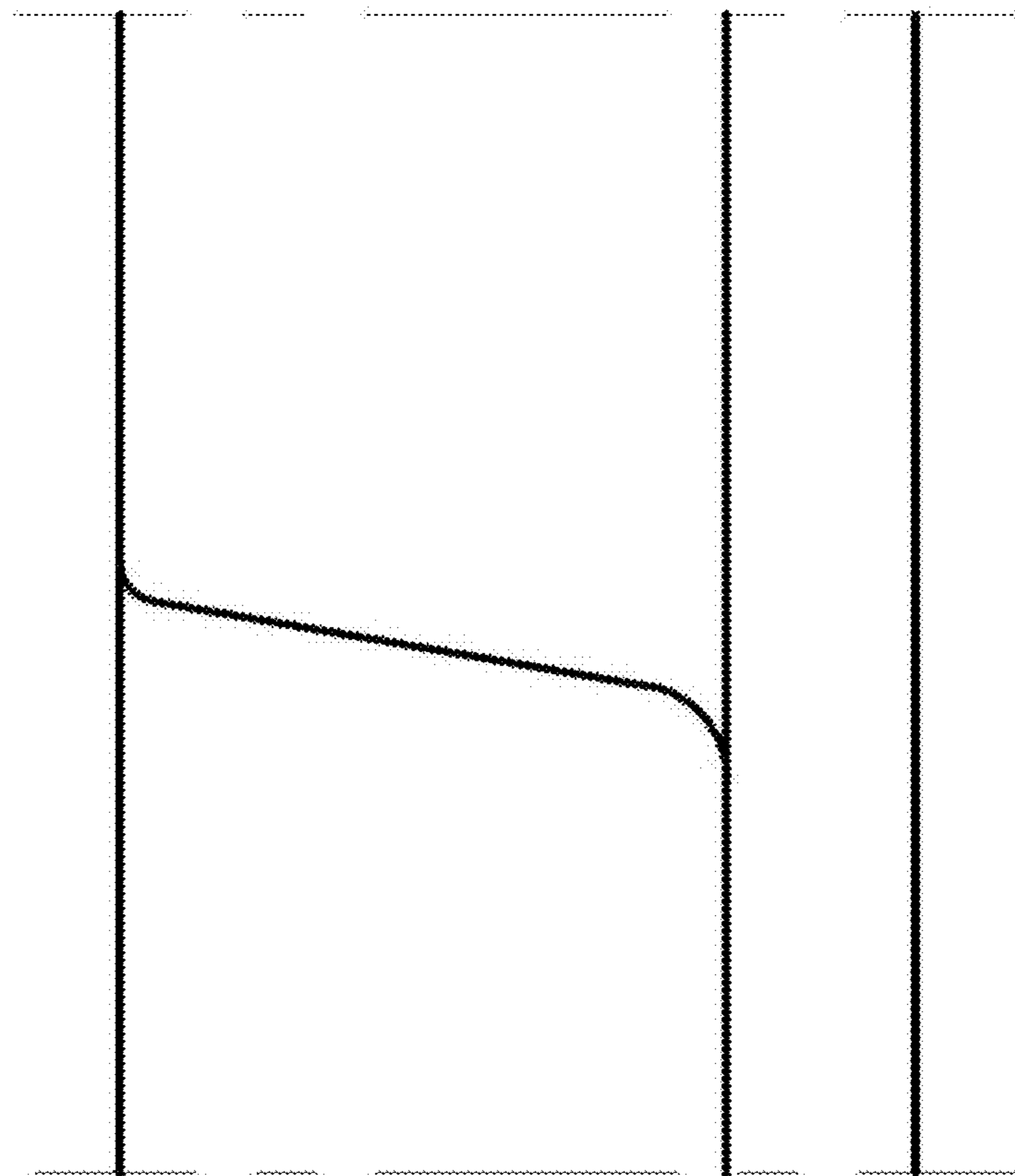

2.8

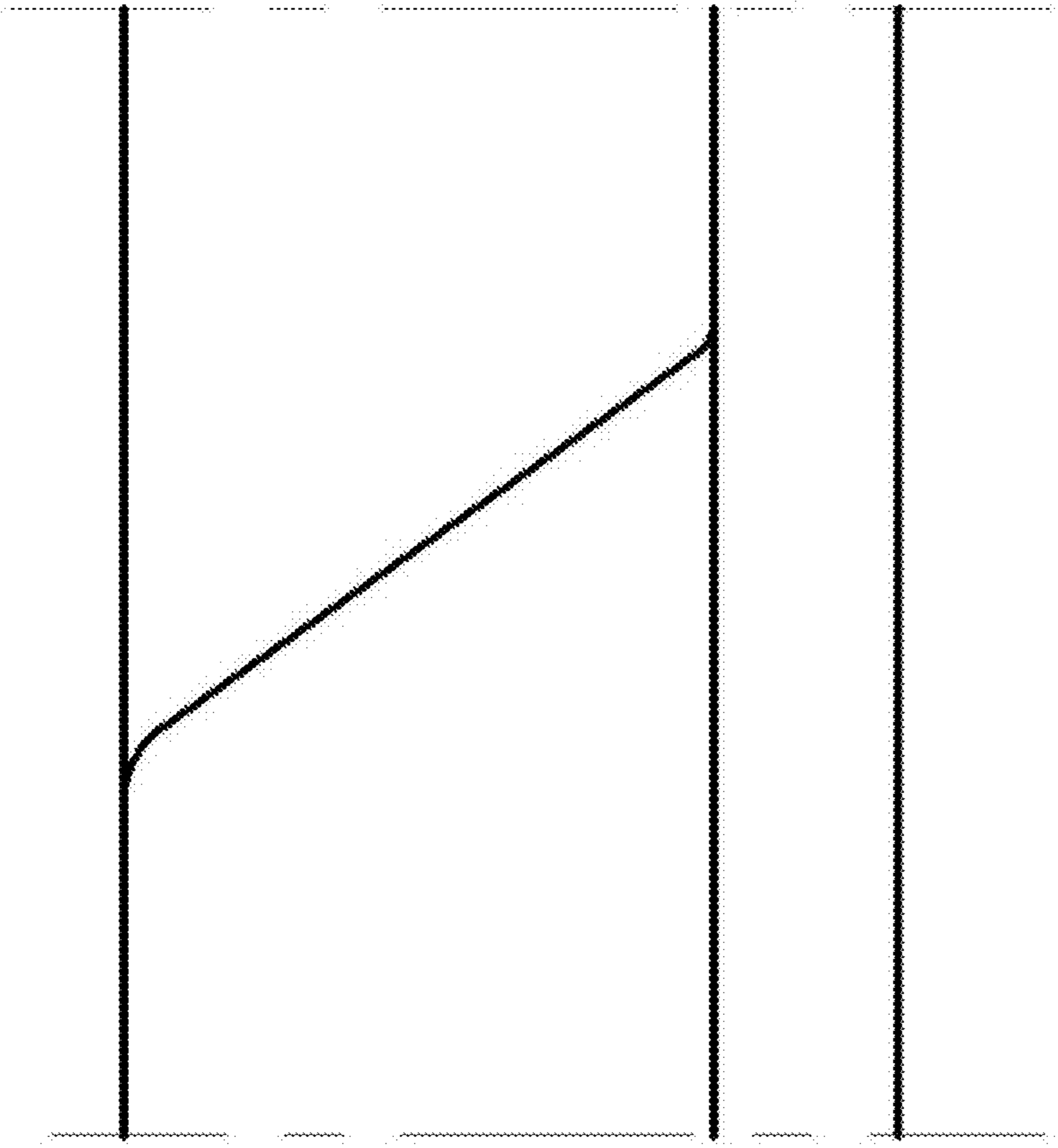

2.9

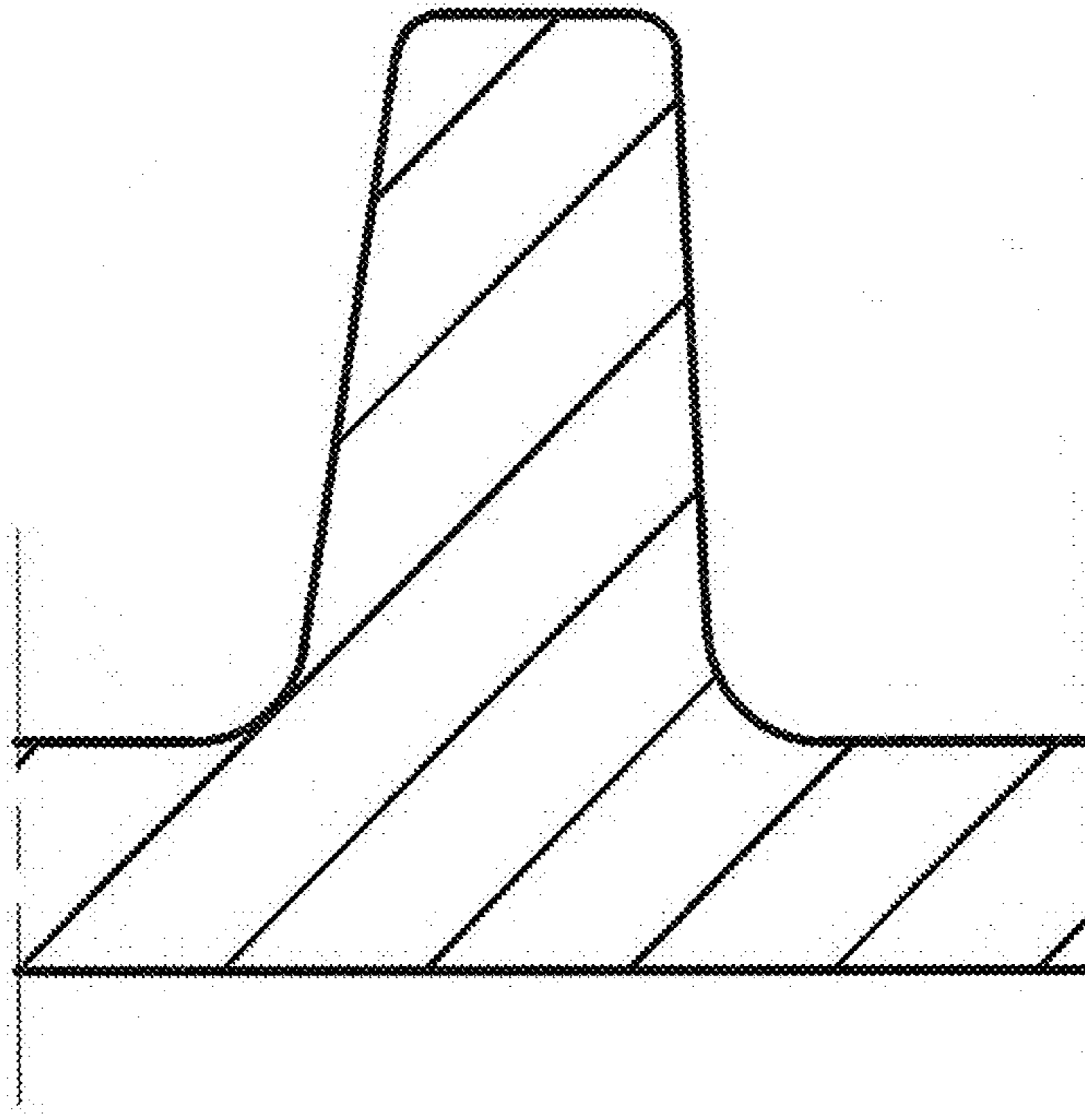

2.10

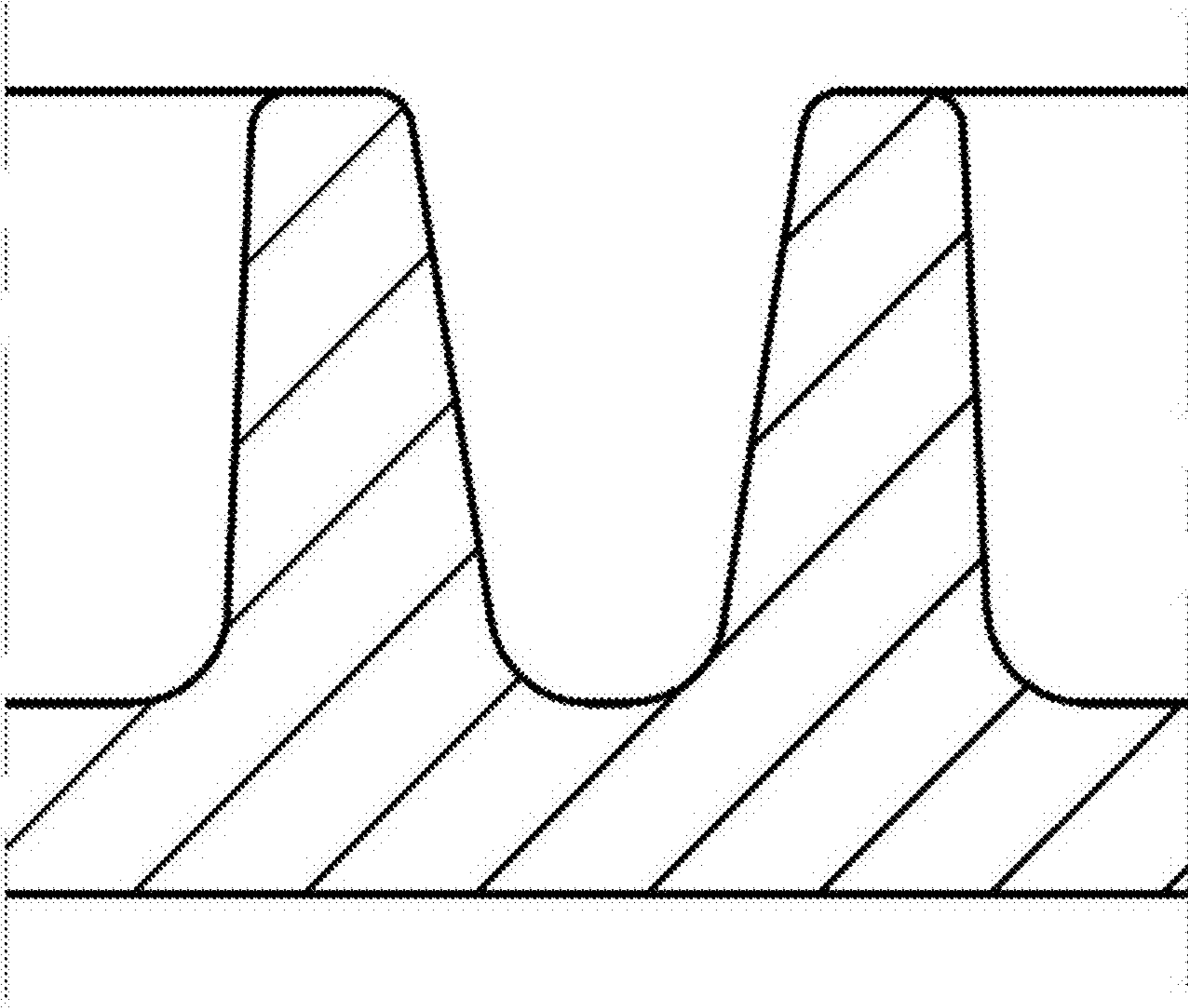

3.1

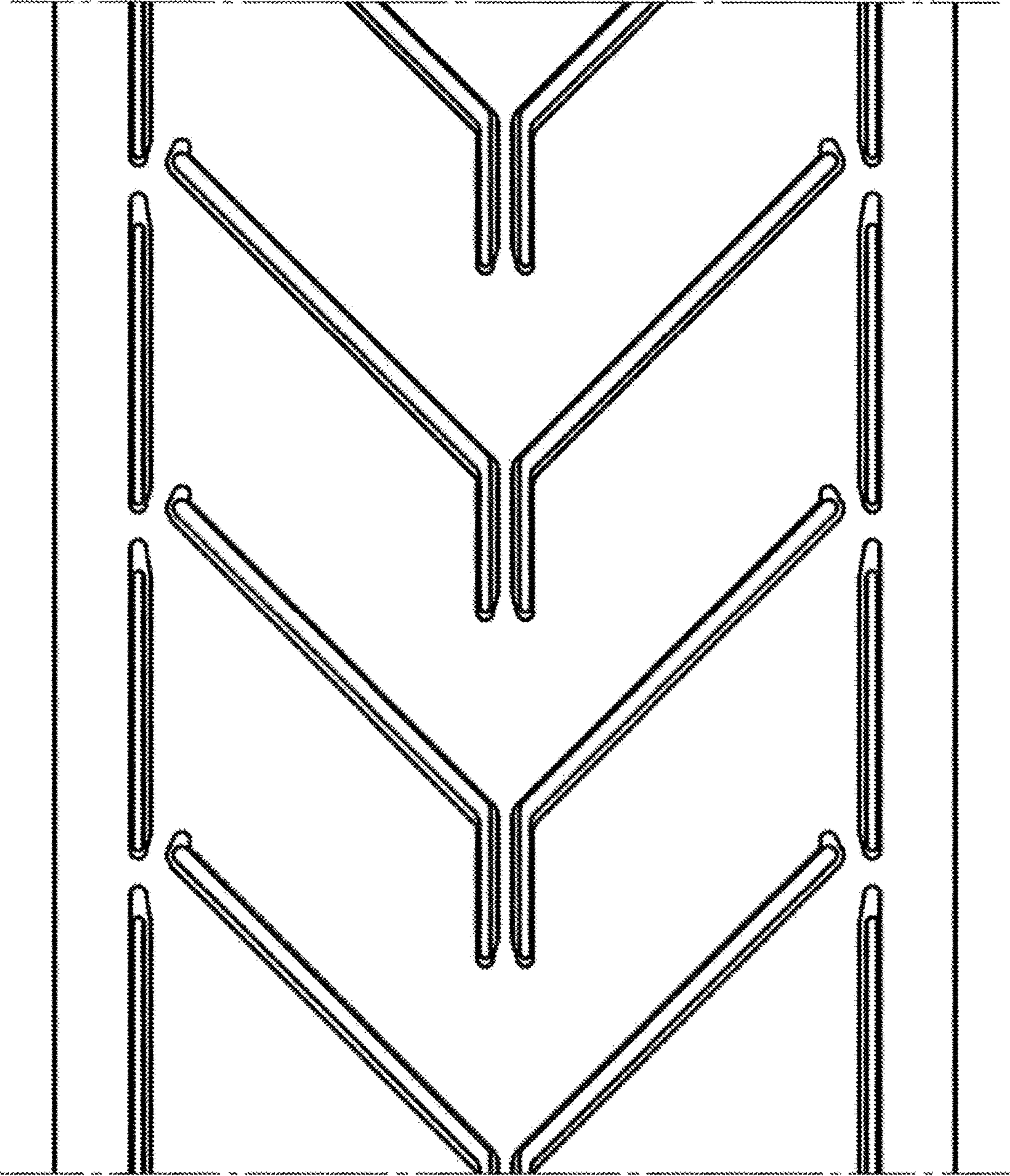

3.2

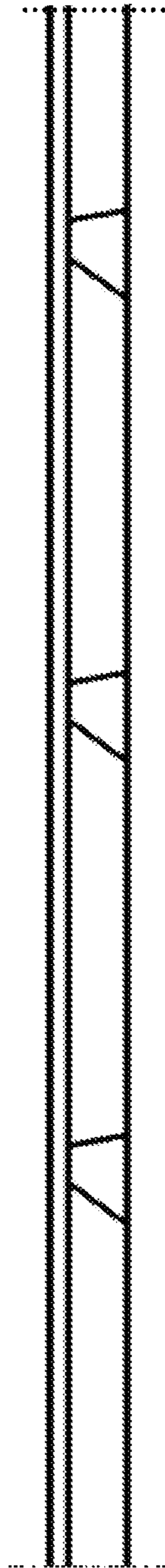

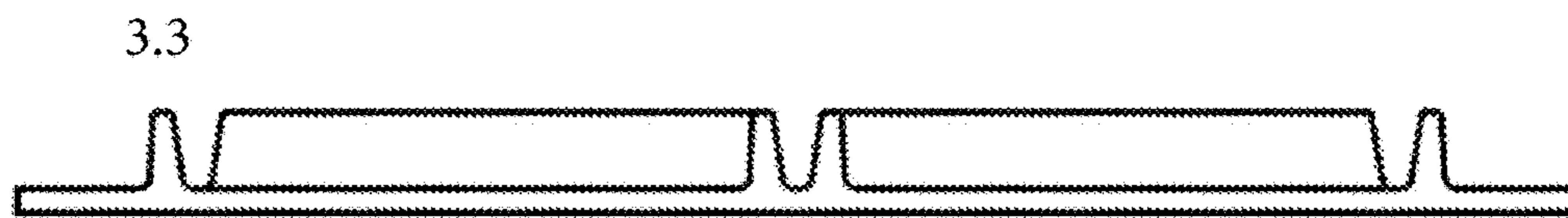

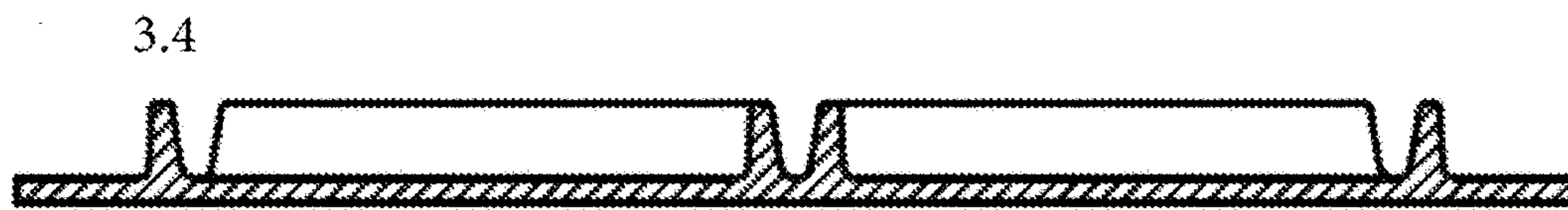

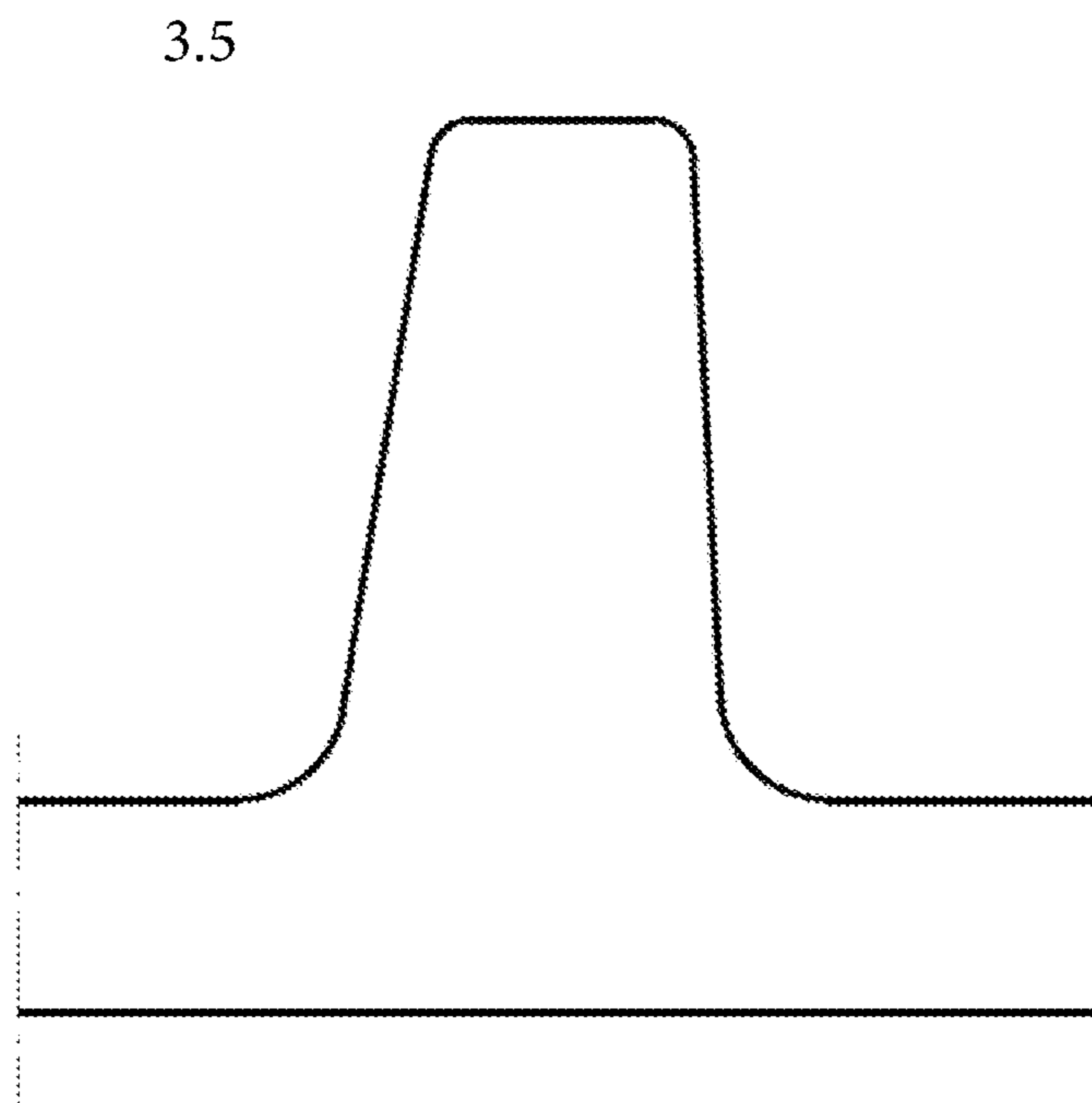

3.6

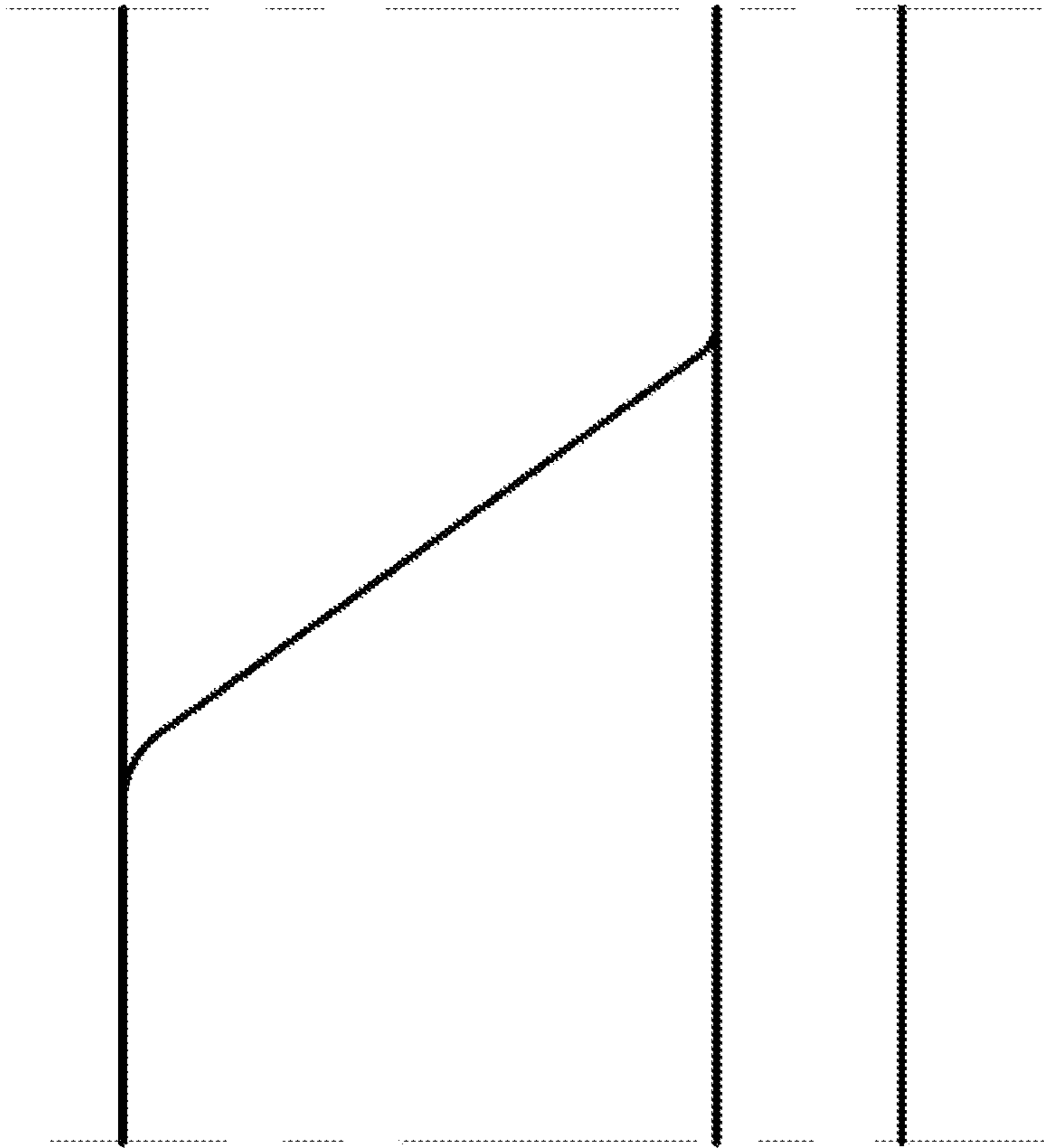

3.7

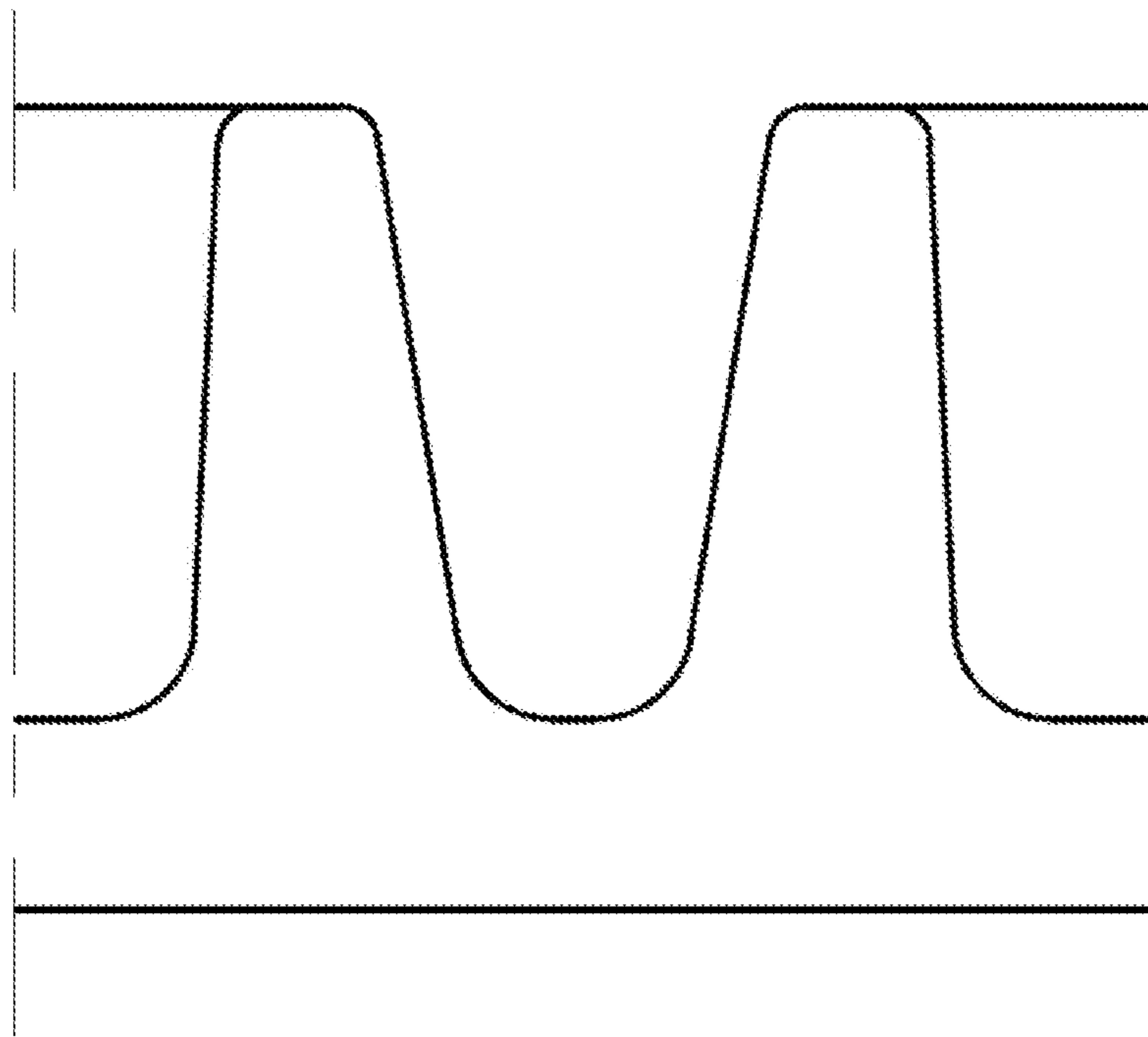

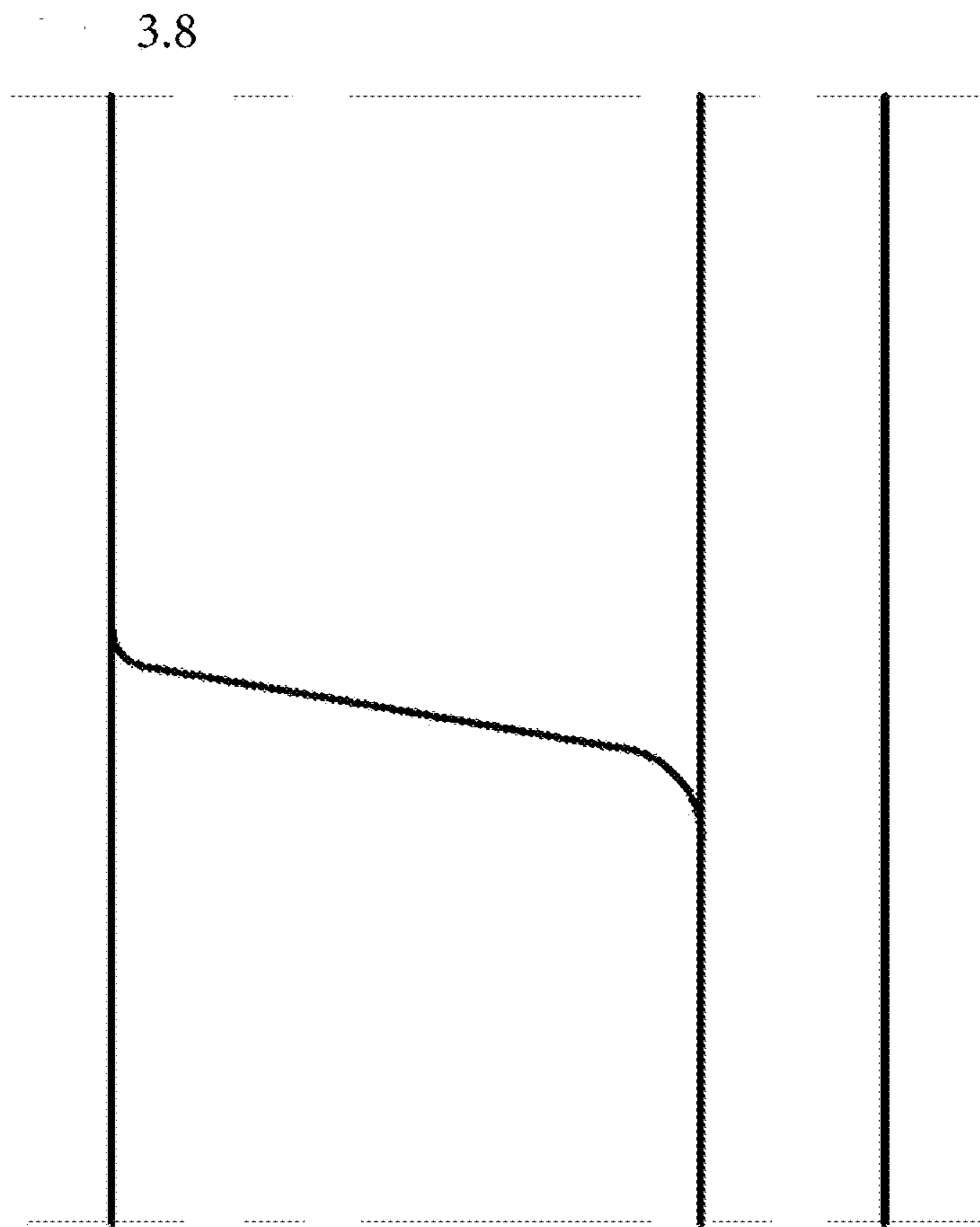

3.9

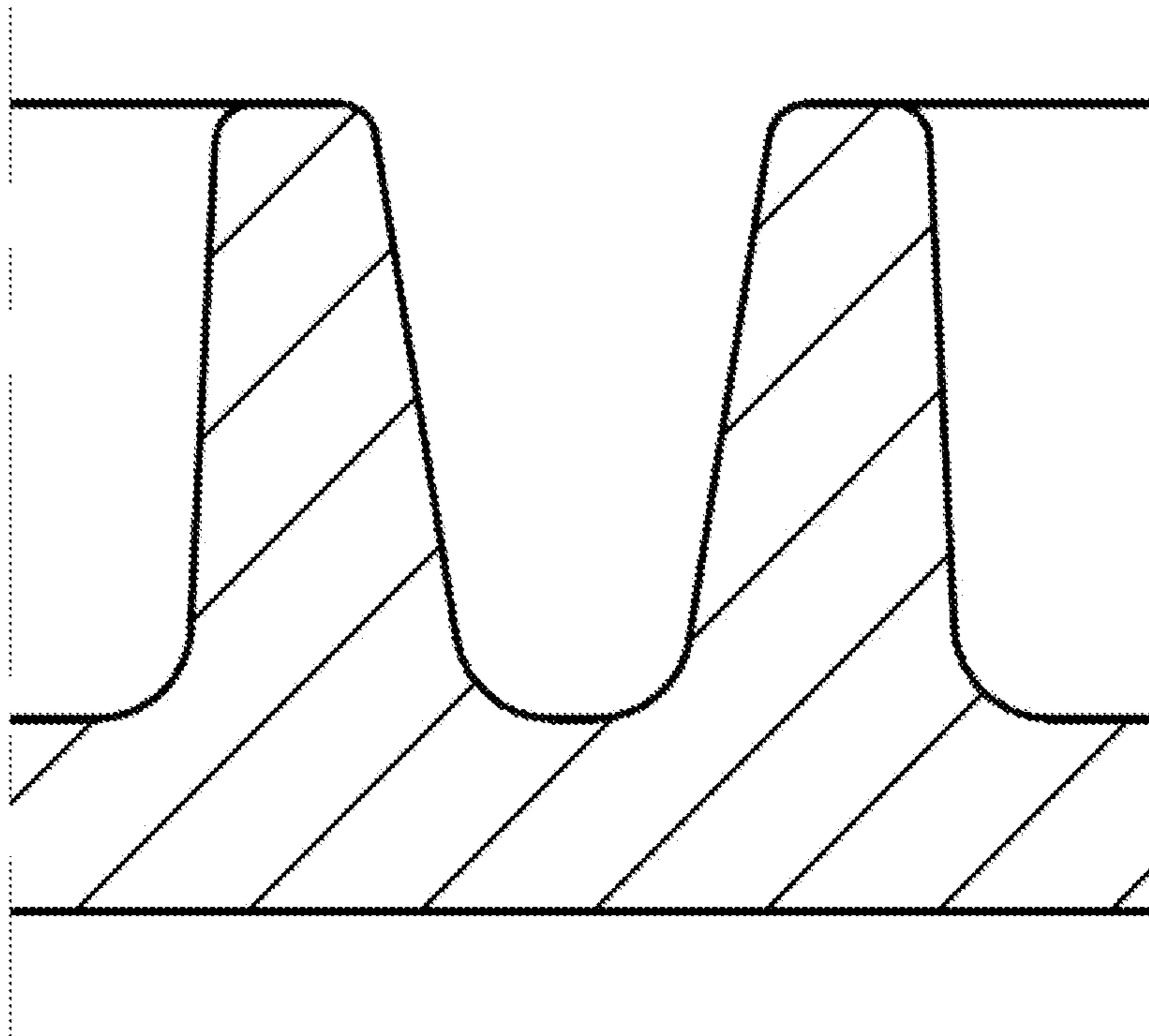

3.10

