



US00D812308S

(12) **United States Design Patent**  
**Hall et al.**

(10) **Patent No.:** **US D812,308 S**

(45) **Date of Patent:** **\*\* Mar. 6, 2018**

(54) **HELMET**

(71) Applicant: **Revision Military S.a.r.L.**,  
Luxembourg (LU)

(72) Inventors: **Edward R. Hall**, Starksboro, VT (US);  
**Stéphane Lebel**, St. Redempteur (CA);  
**Dominic Giroux Bernier**, St-Gabriel de  
Brandon (CA); **Celine Gagnon**,  
St-Jerome (CA); **Bastien Jourde**,  
Montréal (CA); **Philippe Lefebvre**,  
Montréal (CA); **Hugues Rivest**,  
Montréal (CA)

(73) Assignee: **Revision Military S.a.r.L.**,  
Luxembourg (LU)

(\*\*) Term: **15 Years**

(21) Appl. No.: **29/579,756**

(22) Filed: **Oct. 3, 2016**

(51) **LOC (11) Cl.** ..... **09-03**

(52) **U.S. Cl.**  
USPC ..... **D29/102**

(58) **Field of Classification Search**  
USPC ..... D29/107-107, 122  
CPC ..... A63B 71/10; A42B 3/228; A42B 3/32;  
A42B 3/00; A42B 3/08; A42B 3/166;  
A42B 3/222

See application file for complete search history.

(56) **References Cited**

**U.S. PATENT DOCUMENTS**

D410,768 S *	6/1999	Hirsh	.....	D29/102
D481,171 S *	10/2003	Ho	.....	D29/102
D535,059 S *	1/2007	Lam	.....	D29/102
D654,628 S *	2/2012	Aris	.....	D29/102
D655,048 S *	2/2012	Moeller	.....	D29/102
D677,006 S *	2/2013	Pfanner	.....	D29/102

D691,329 S *	10/2013	Anderson	.....	D29/102
D699,896 S *	2/2014	Ho	.....	D29/102
D733,972 S *	7/2015	Szalkowski	.....	D29/102
D744,170 S *	11/2015	Eastwood	.....	D29/102
D752,814 S *	3/2016	Chilson	.....	D29/102
D759,899 S *	6/2016	Finiel	.....	D29/102
D771,874 S *	11/2016	Chilson	.....	D29/102
D776,357 S *	1/2017	Marting	.....	D29/102
D779,126 S *	2/2017	Uhm	.....	D29/102
2012/0011631 A1	1/2012	Crossman et al.		

\* cited by examiner

*Primary Examiner* — Ruth McInroy

(74) *Attorney, Agent, or Firm* — Wolf, Greenfield & Sacks, P.C.

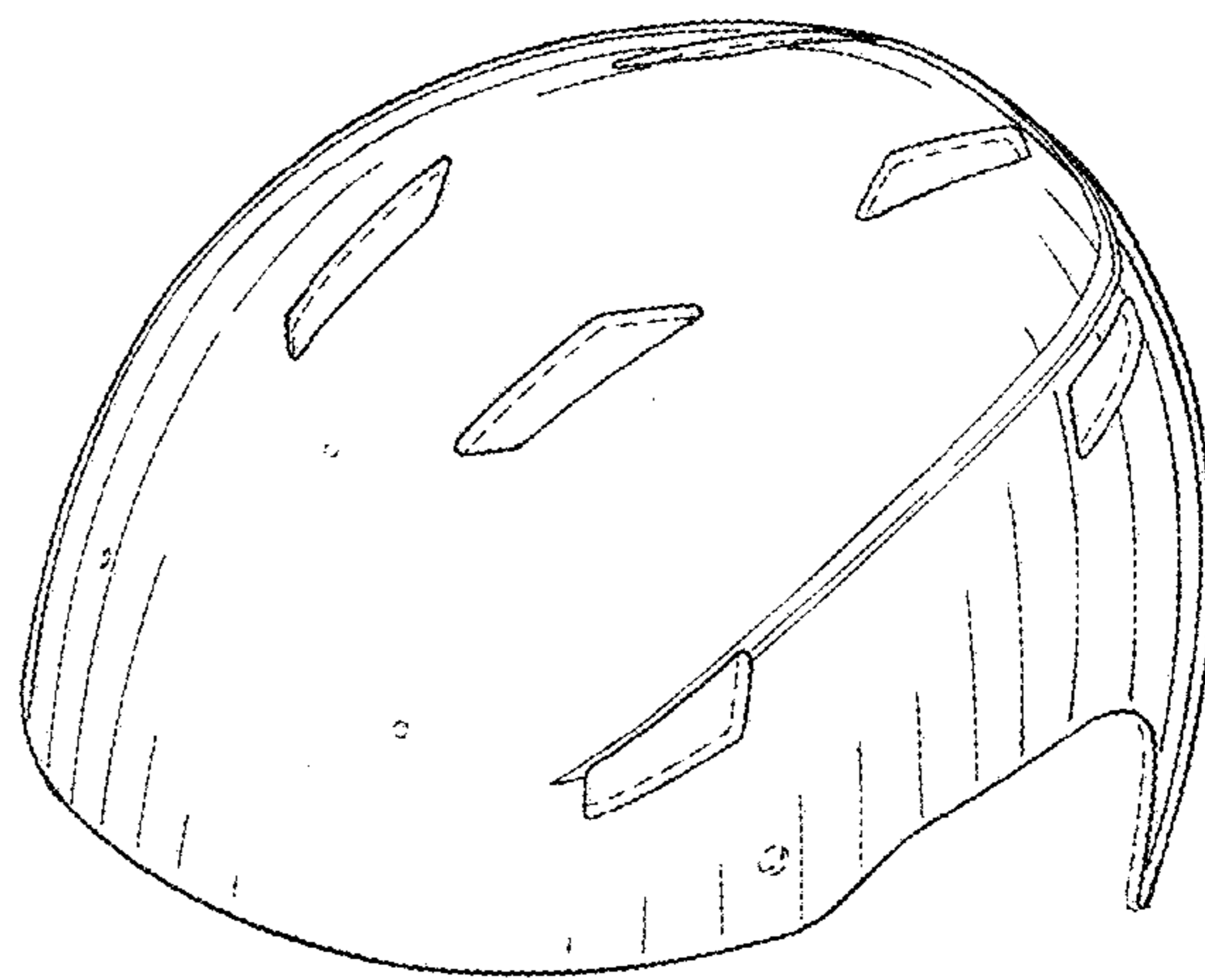
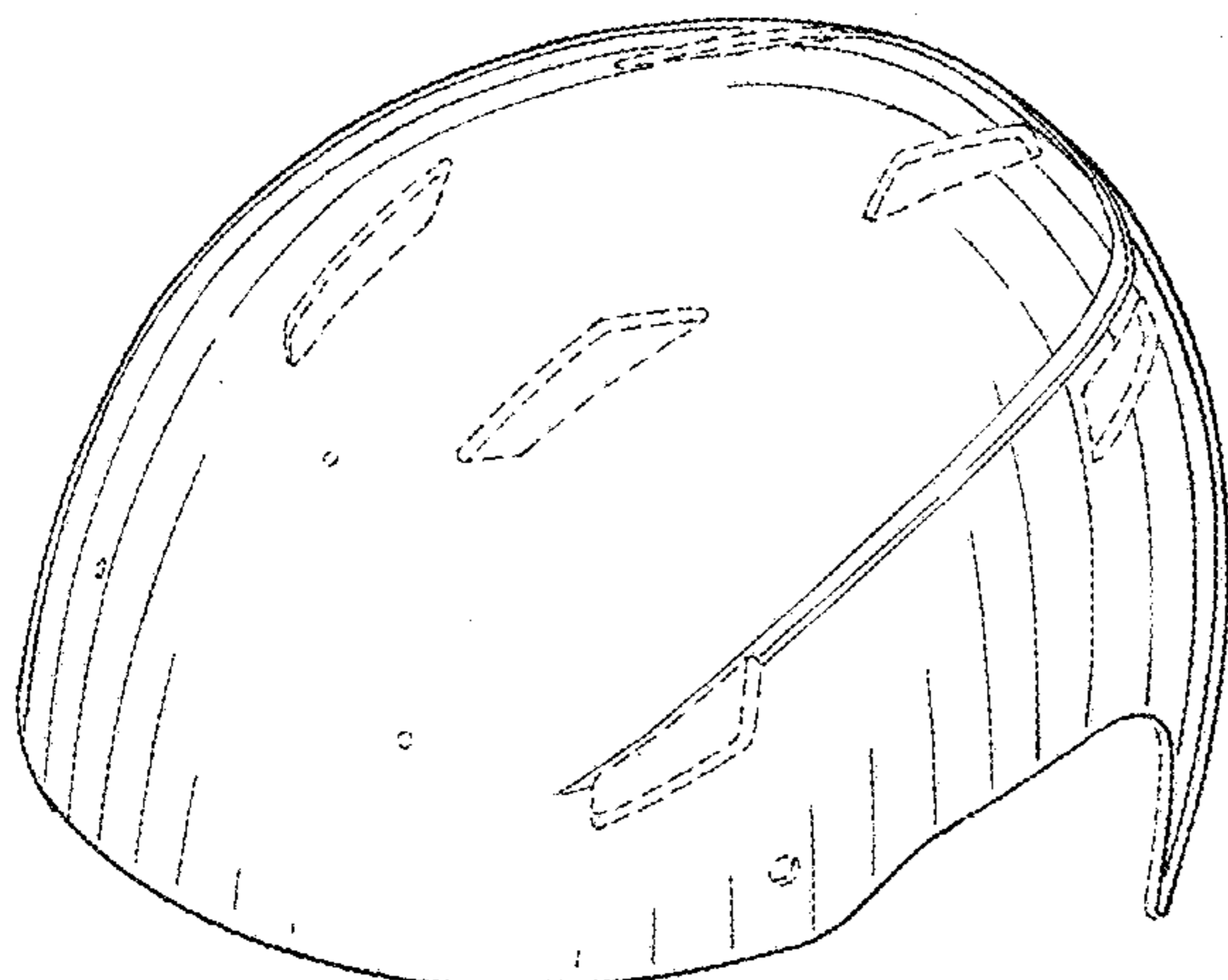
(57) **CLAIM**

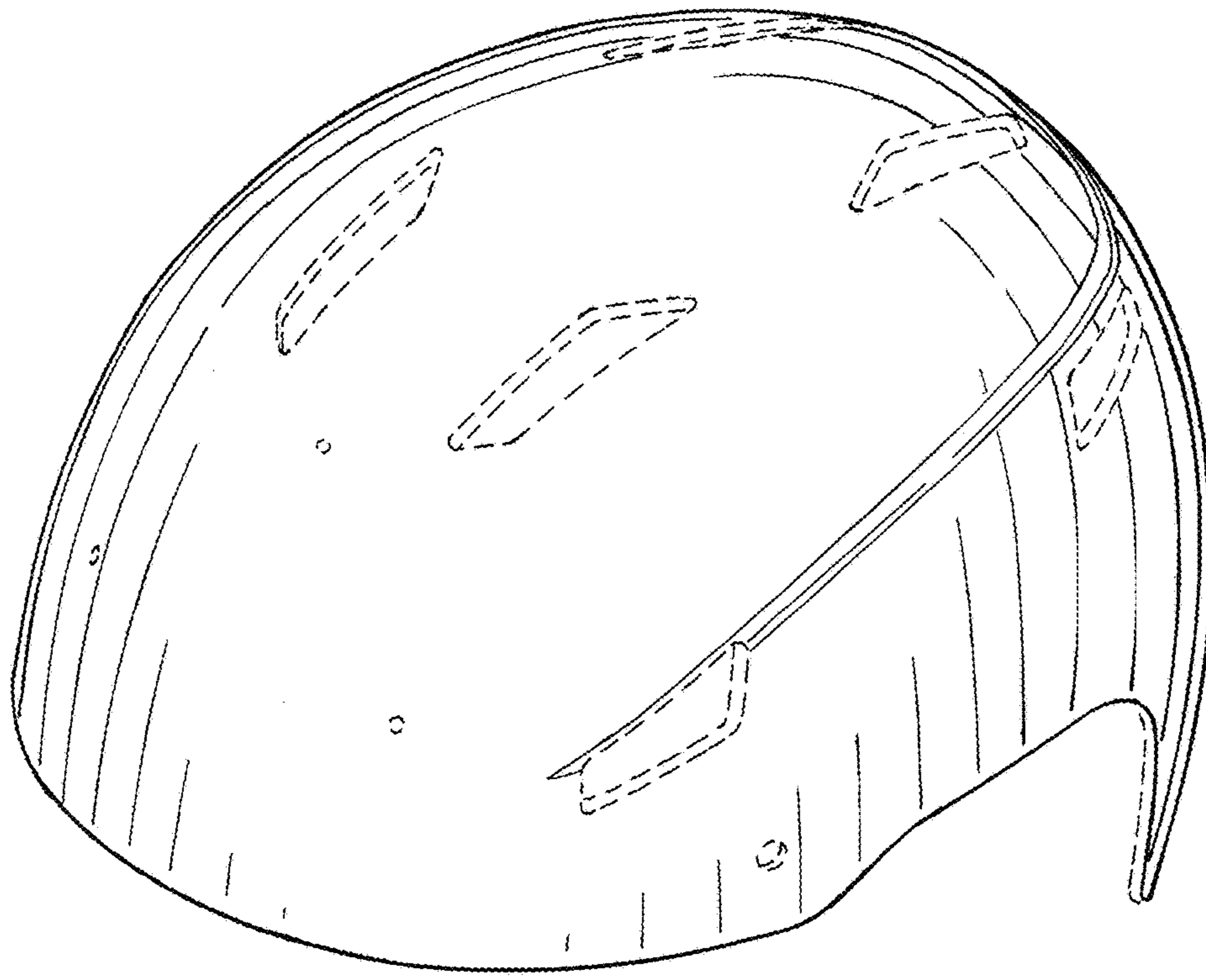
The ornamental design for a helmet, as shown and described.

**DESCRIPTION**

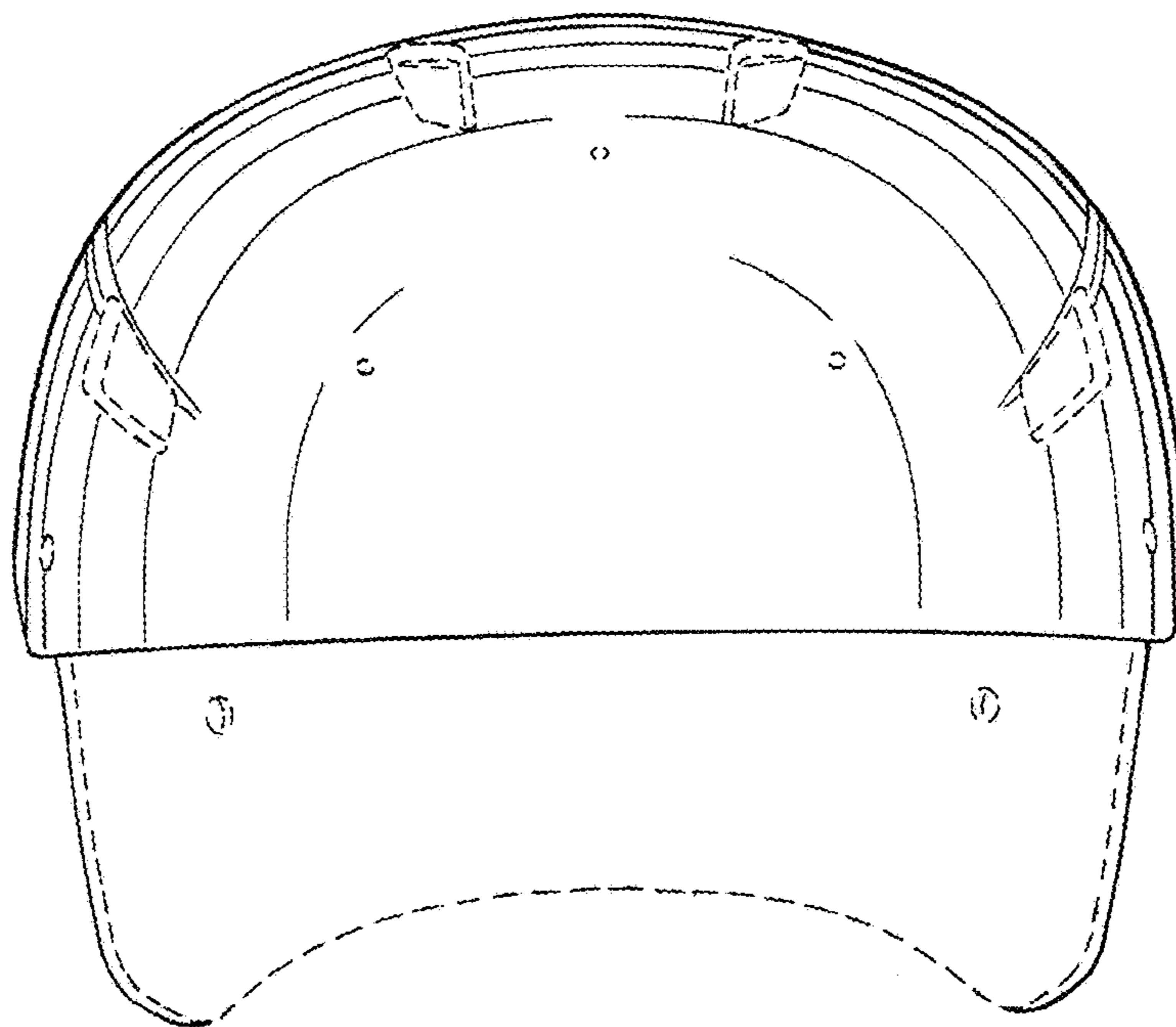
FIG. 1 is a top, front, right side perspective view of a helmet showing a first embodiment of our new design;  
 FIG. 2 is a front elevation view thereof;  
 FIG. 3 is a rear elevation view thereof;  
 FIG. 4 is a left side elevation view thereof;  
 FIG. 5 is a right side elevation view thereof;  
 FIG. 6 is a top plan view thereof;  
 FIG. 7 is a bottom plan view thereof;  
 FIG. 8 is a top, front, right side perspective view of a second embodiment thereof;  
 FIG. 9 is a front elevation view of FIG. 8;  
 FIG. 10 is a rear elevation view of FIG. 8;  
 FIG. 11 is a left side elevation view of FIG. 8;  
 FIG. 12 is a right side elevation view of FIG. 8;  
 FIG. 13 is a top plan view of FIG. 8; and,  
 FIG. 14 is a bottom plan view of FIG. 8.  
 The broken lines illustrate portions of the helmet that form no part of the claimed design.

**1 Claim, 10 Drawing Sheets**

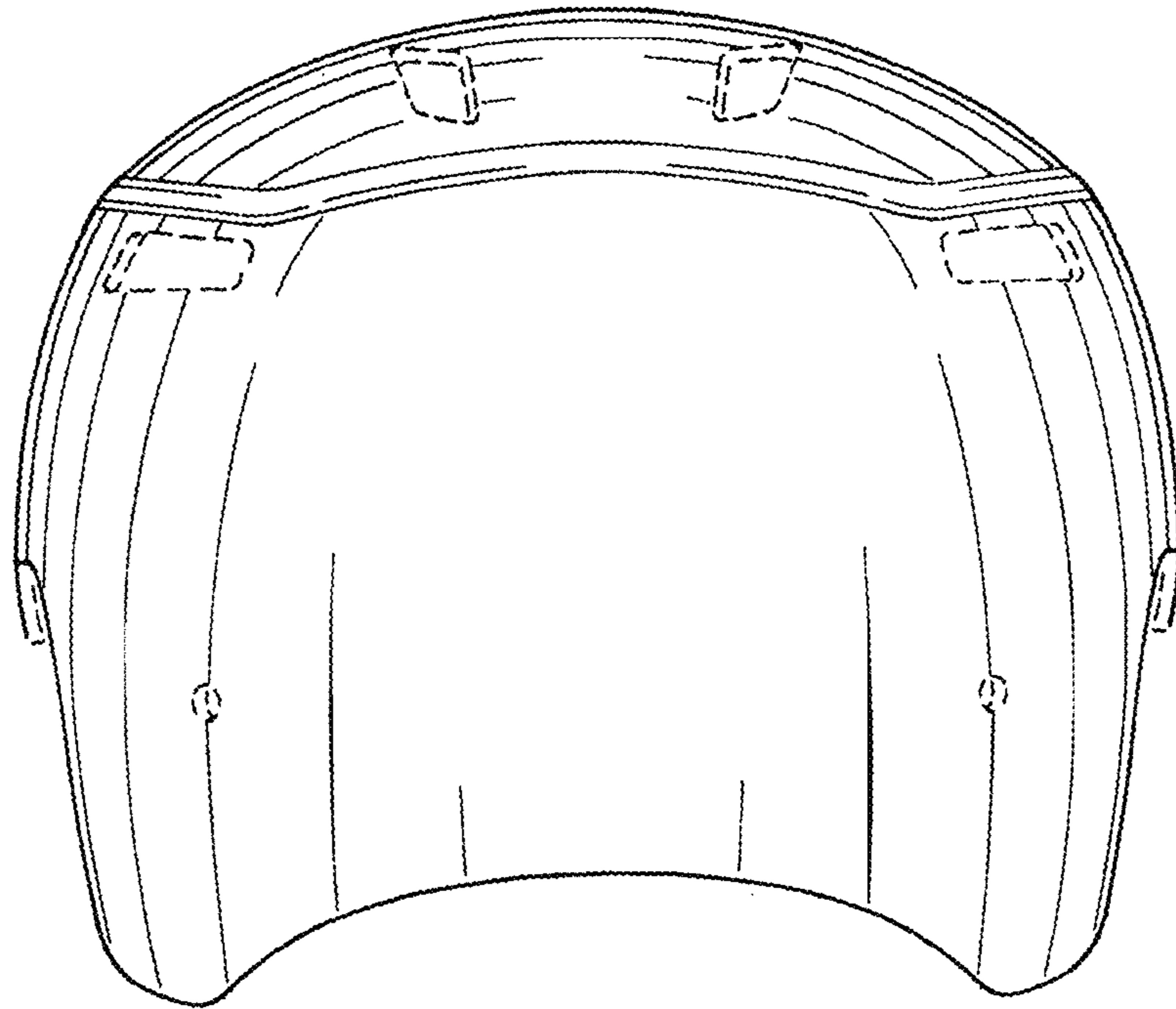




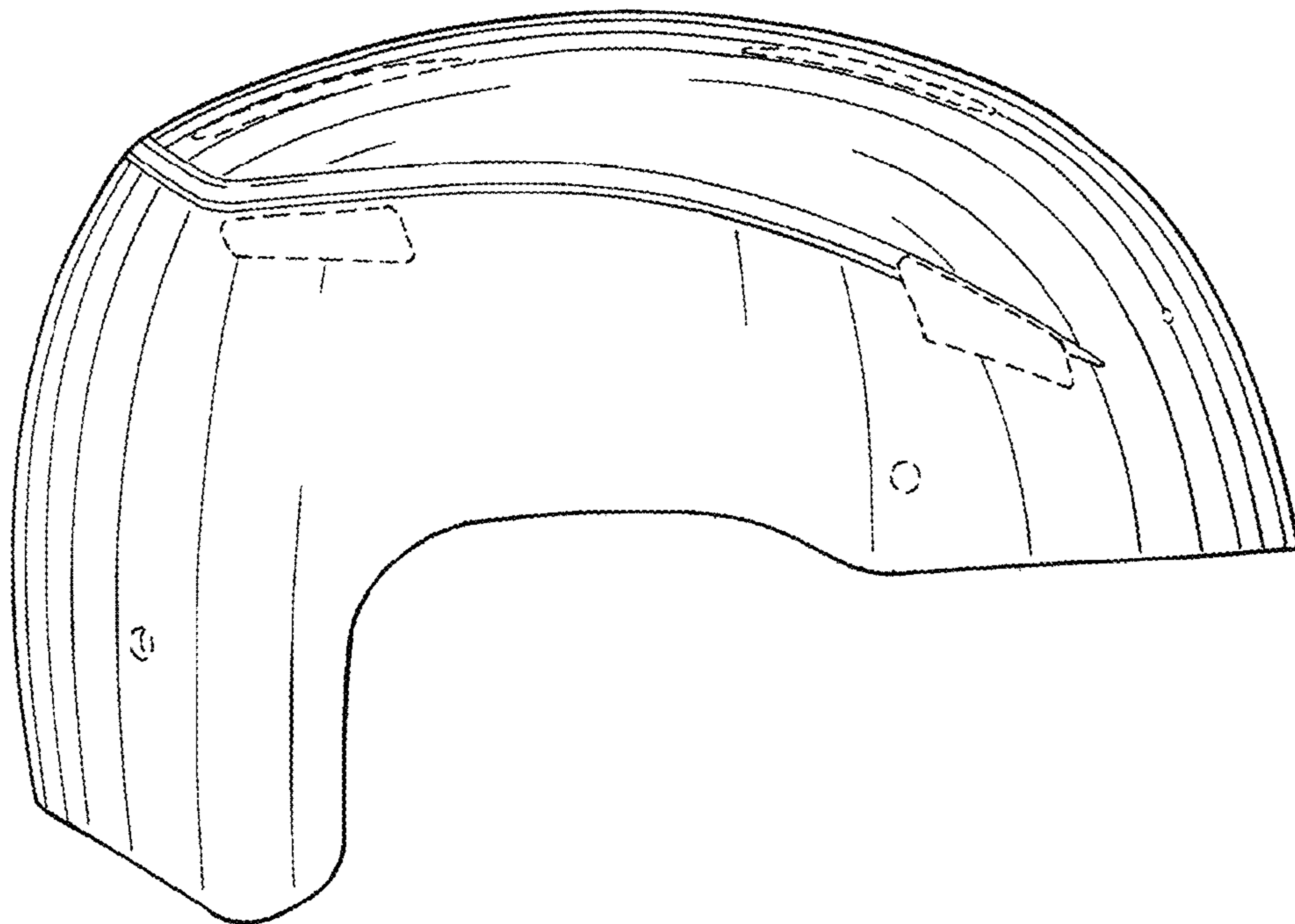
*Fig. 1*



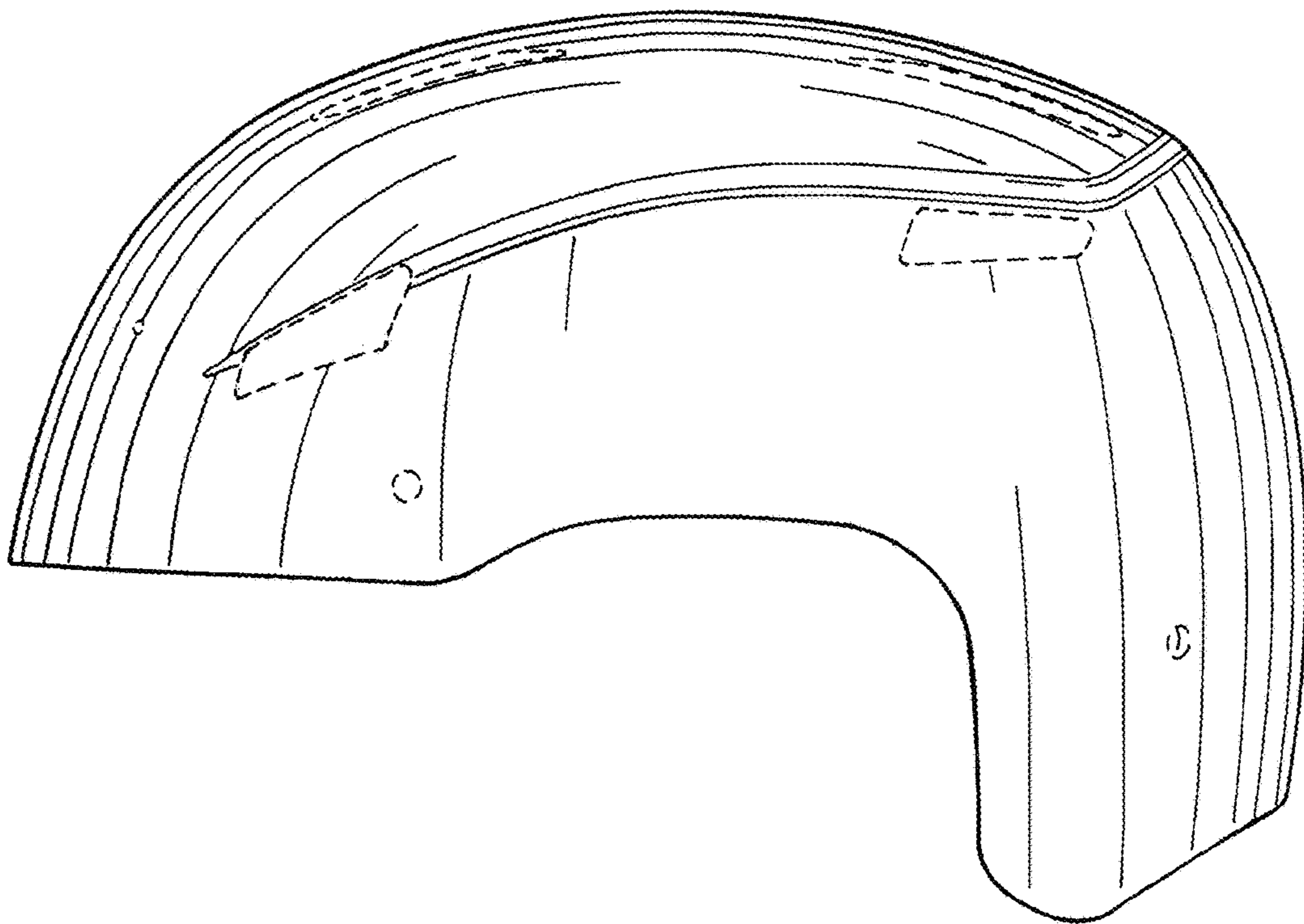
*Fig. 2*



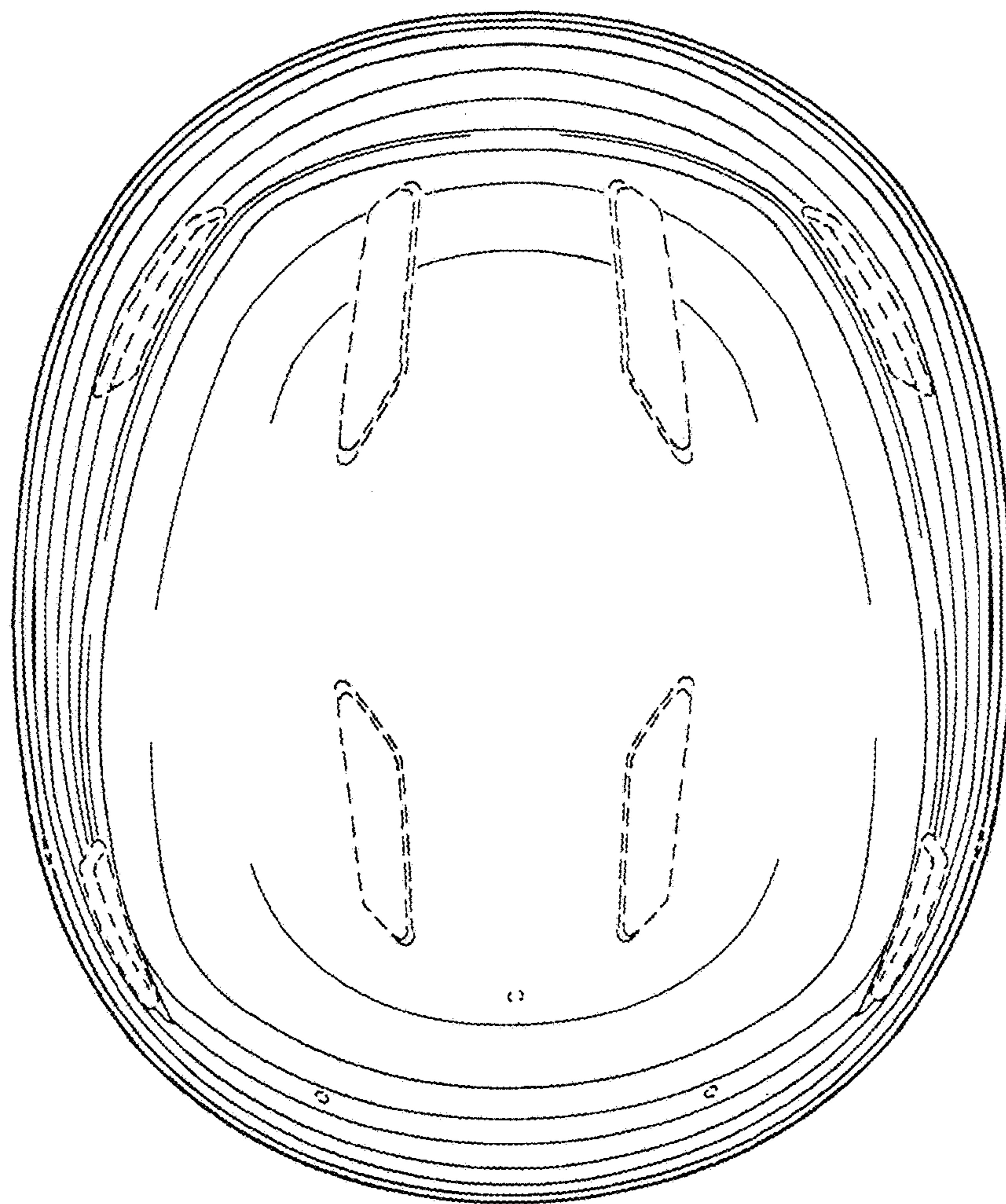
*Fig. 3*



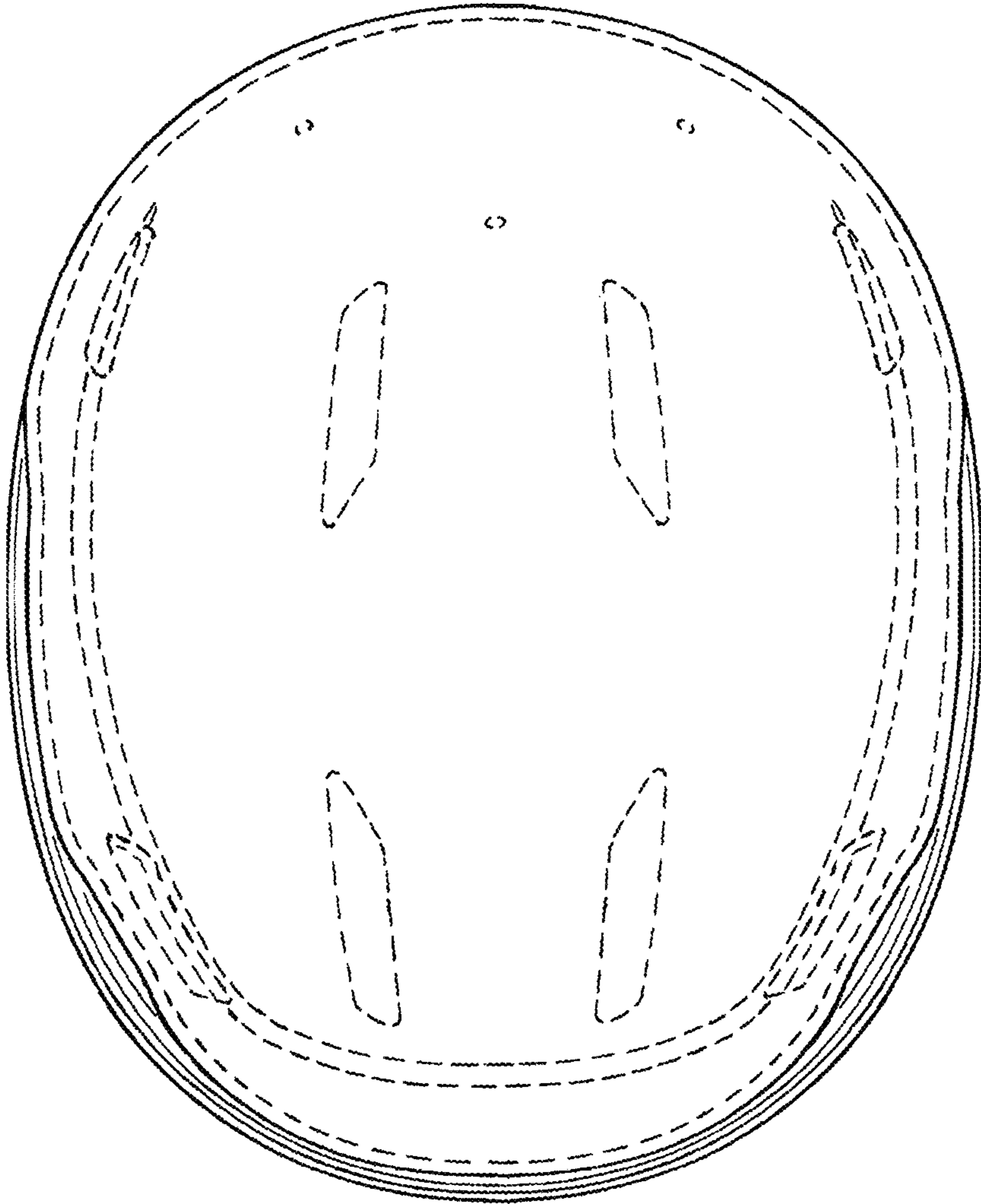
*Fig. 4*



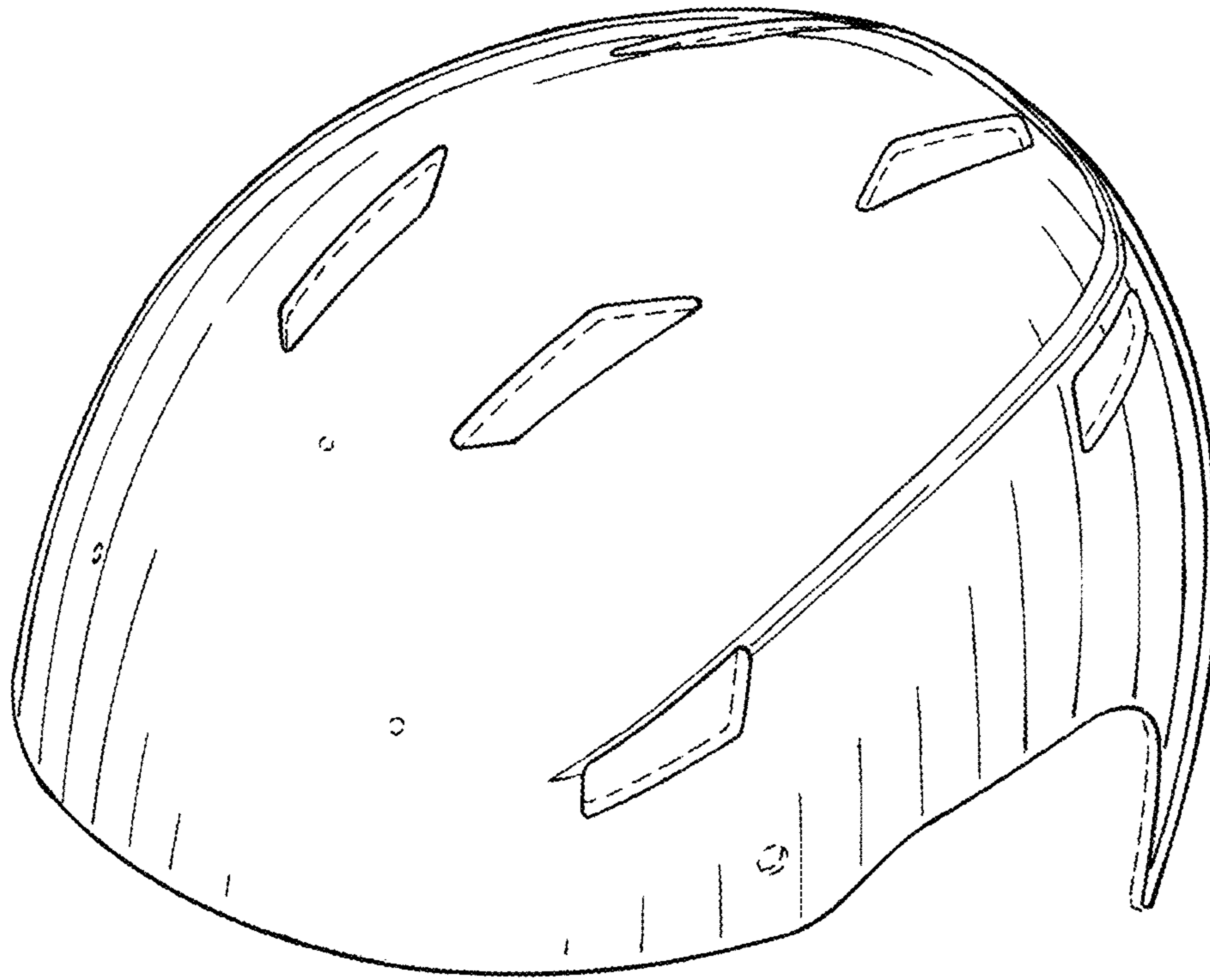
*Fig. 5*



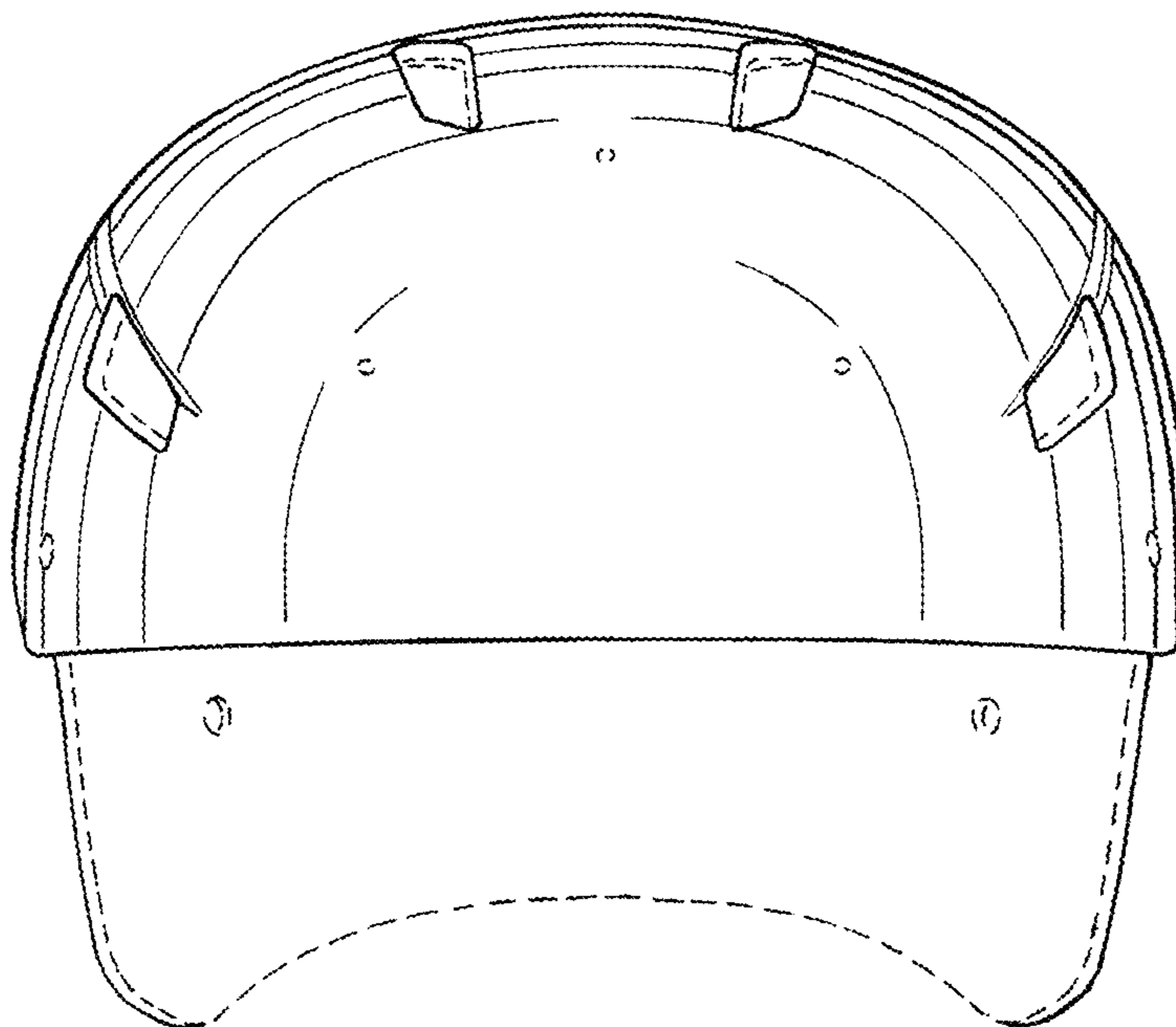
*Fig. 6*



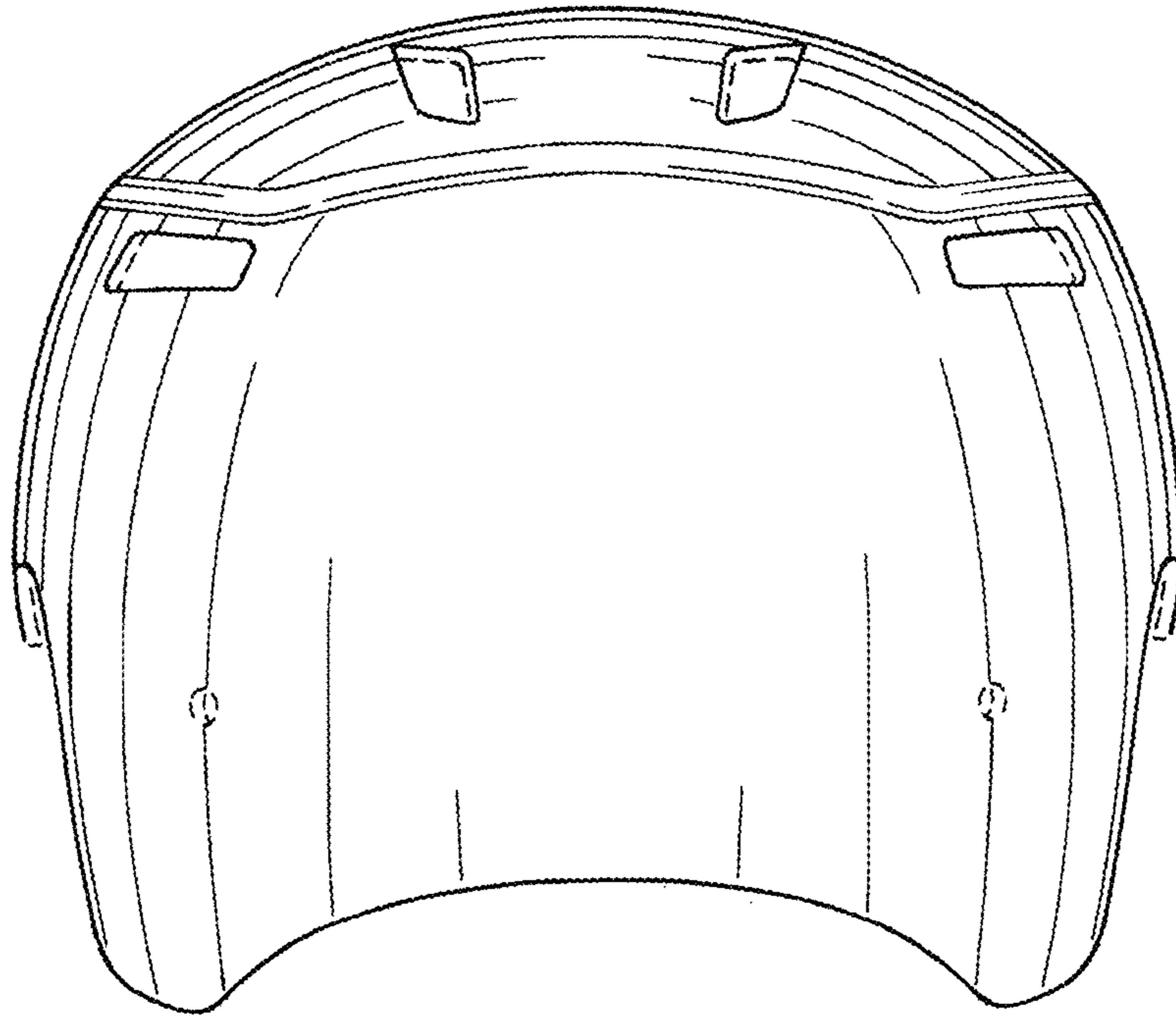
*Fig. 7*



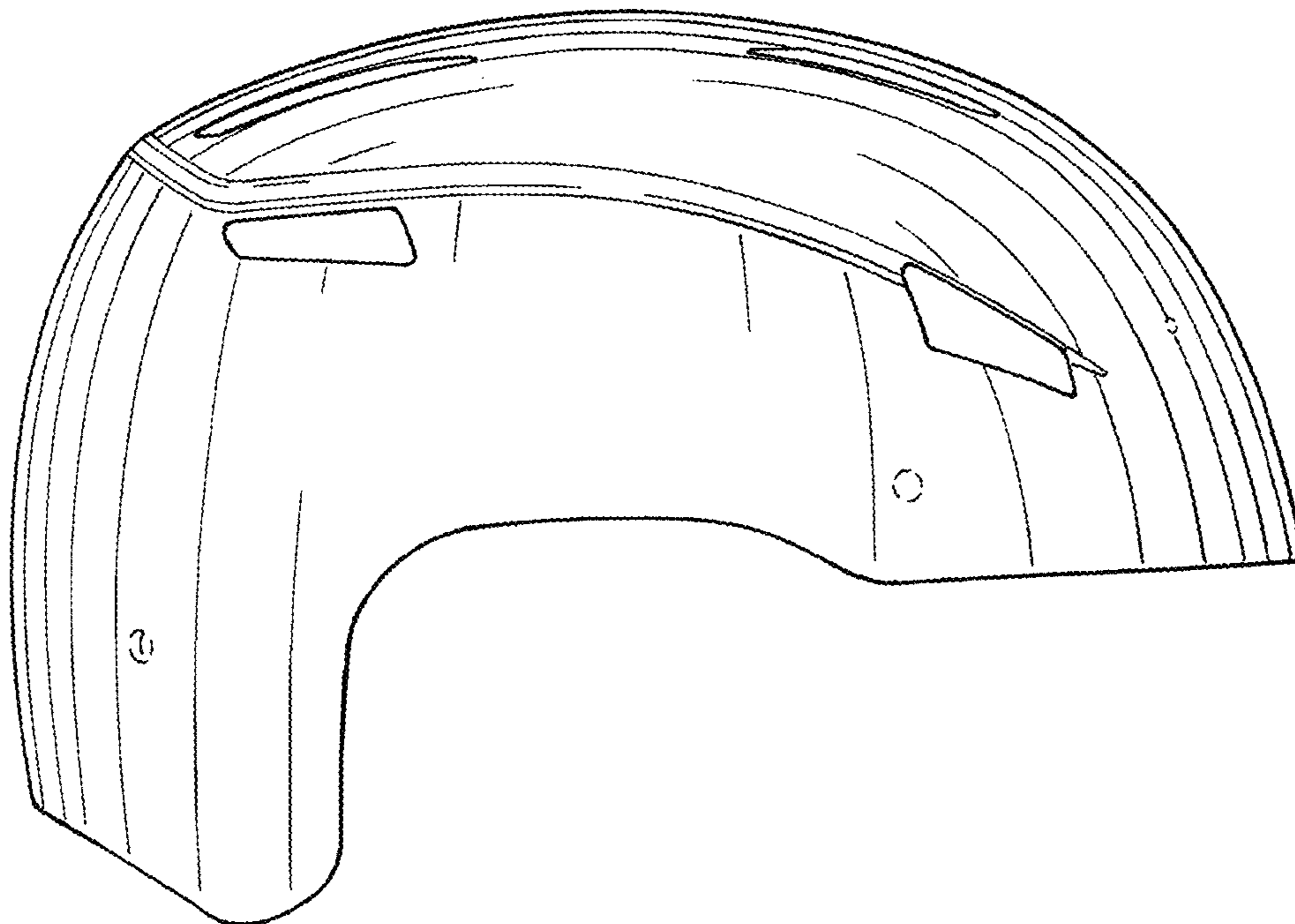
*Fig. 8*



*Fig. 9*

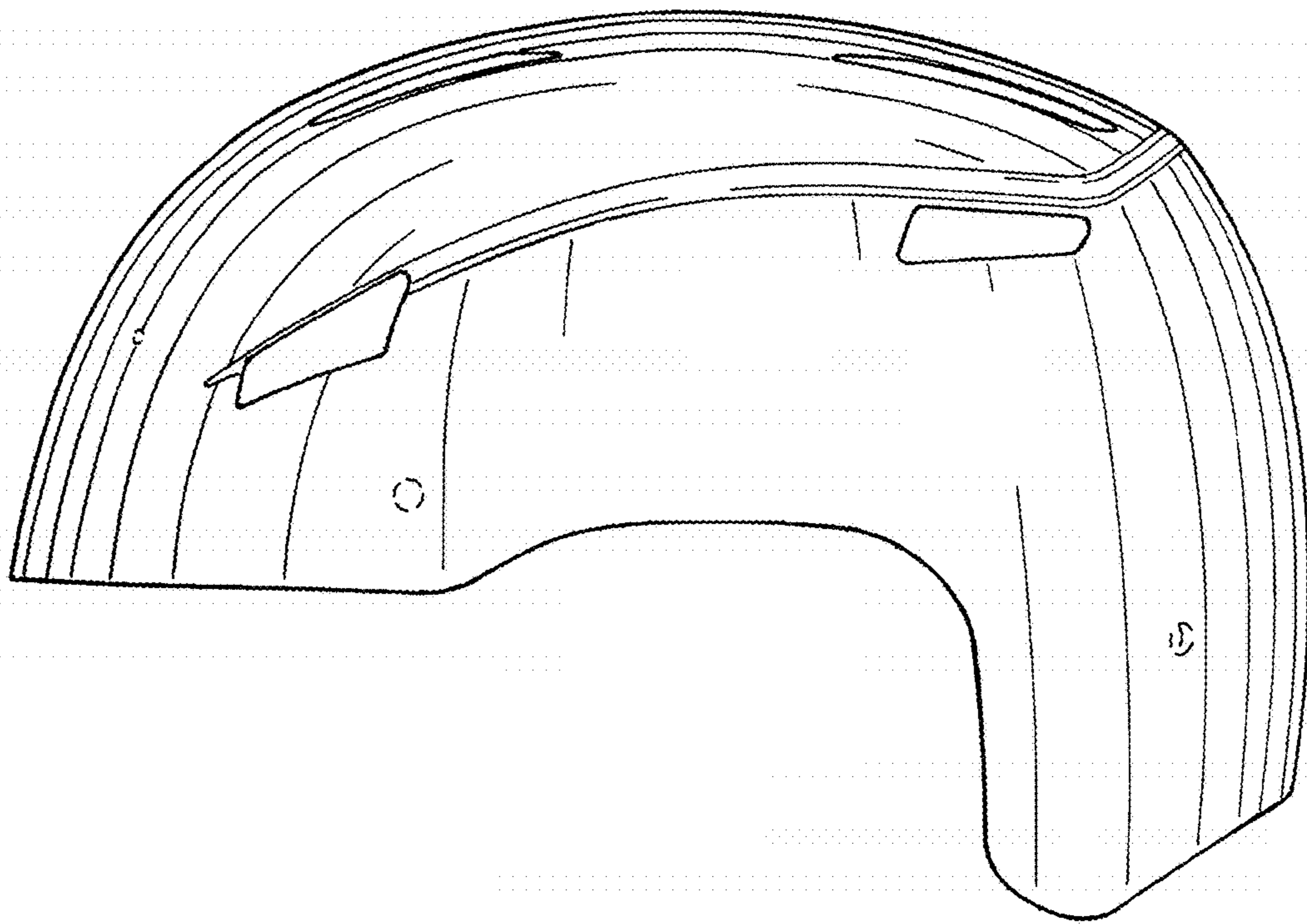


*Fig. 10*

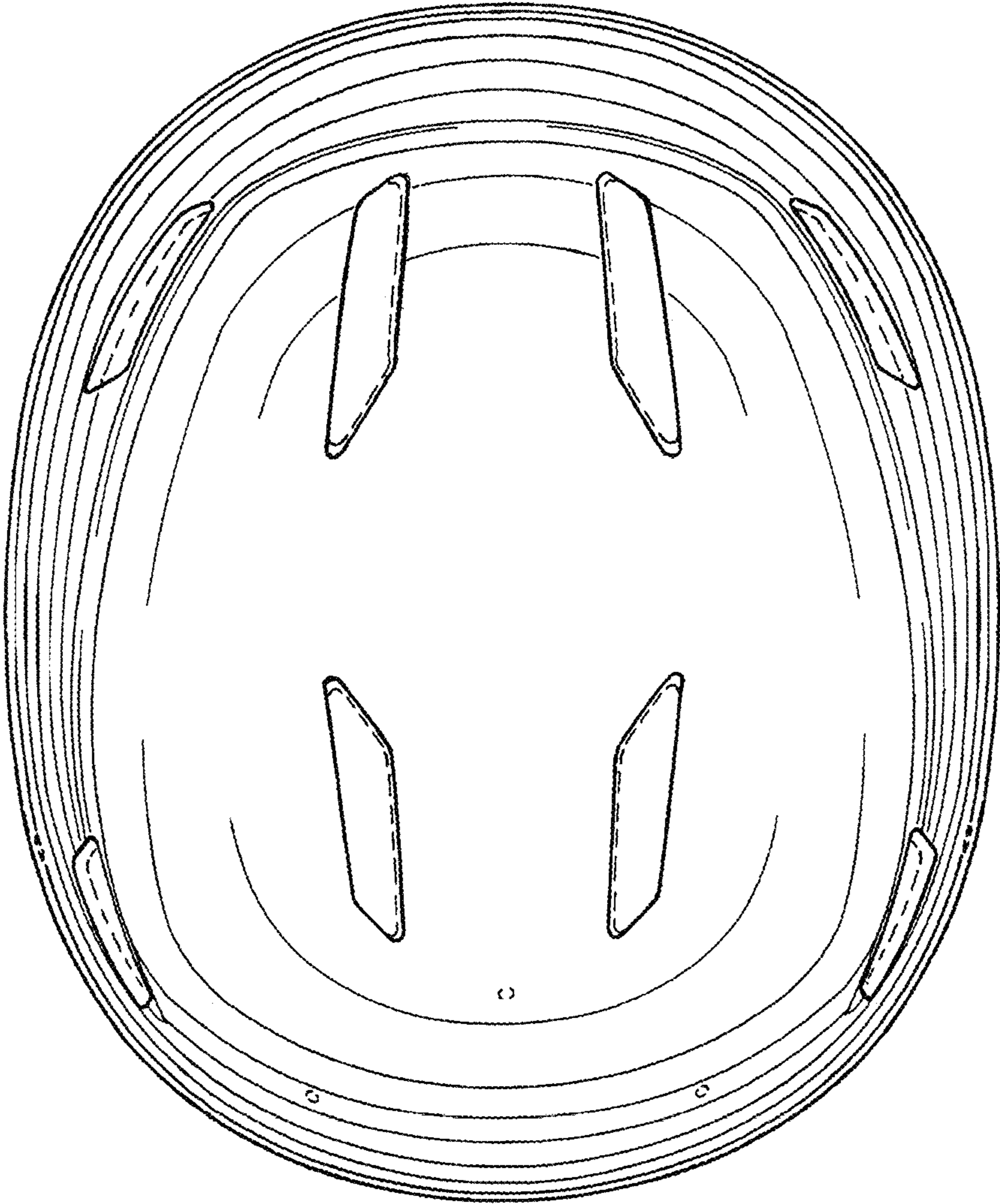


*Fig. 11*

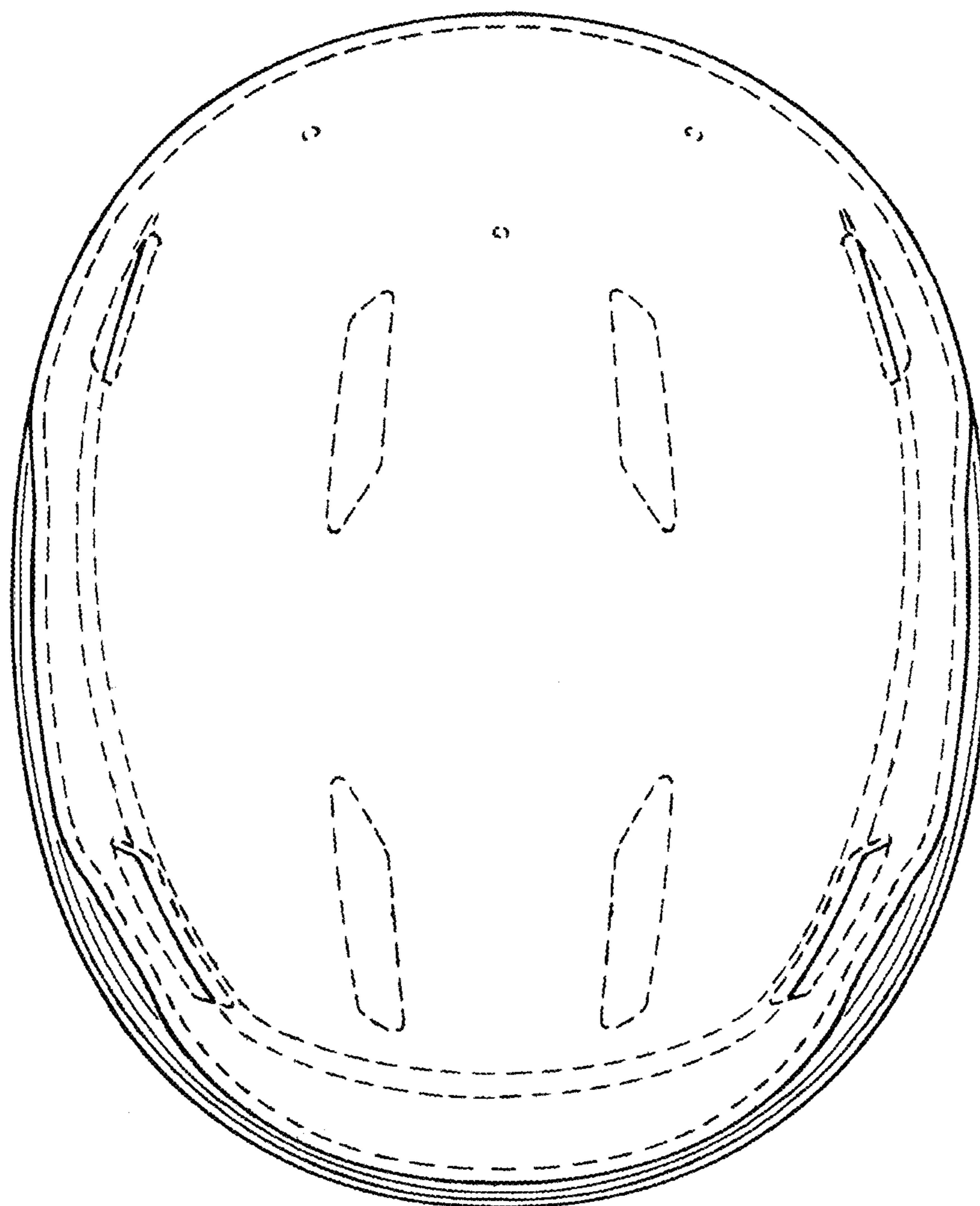




*Fig. 12*



*Fig. 13*



*Fig. 14*