



US00D812148S

(12) **United States Design Patent** (10) **Patent No.:** **US D812,148 S**  
**Castro et al.** (45) **Date of Patent:** **\*\* Mar. 6, 2018**

(54) **GAMING MACHINE WITH CURVED DISPLAY**

(71) Applicant: **Bally Gaming, Inc.**, Las Vegas, NV (US)

(72) Inventors: **Christian L. Castro**, Chicago, IL (US);  
**Robert J. Glenn, II**, Chicago, IL (US);  
**Paul M. Lesley**, Blue Island, IL (US)

(73) Assignee: **BALLY GAMING, INC.**, Las Vegas, NV (US)

(\*\*) Term: **15 Years**

(21) Appl. No.: **29/598,304**

(22) Filed: **Mar. 24, 2017**

**Related U.S. Application Data**

(63) Continuation of application No. 29/559,629, filed on Mar. 30, 2016.

(51) **LOC (11) Cl.** ..... **21-03**

(52) **U.S. Cl.**  
USPC ..... **D21/369**

(58) **Field of Classification Search**  
USPC ..... D21/369, 370, 371, 385, 329, 325, 394;  
D14/307, 172, 129, 325, 401, 371, 126,  
(Continued)

(56) **References Cited**

**U.S. PATENT DOCUMENTS**

2,661,954 A 12/1953 Koci  
D236,720 S 9/1975 Baker  
(Continued)

**FOREIGN PATENT DOCUMENTS**

EP 649 671 A1 4/1995  
JP 03210172 B2 9/2001  
(Continued)

**OTHER PUBLICATIONS**

TwinStar J43 Overview by SG Gaming dated Nov. 7, 2016. Found online [Dec. 13, 2017]https://www.youtube.com/watch?v=WfVHKlz-oDM.\*

(Continued)

*Primary Examiner* — Robert M. Spear

*Assistant Examiner* — Ryan Harvey

(74) *Attorney, Agent, or Firm* — Banner & Witcoff, Ltd.

(57) **CLAIM**

We claim the ornamental design for a gaming machine with curved display, as shown and described.

**DESCRIPTION**

FIG. 1 is a left isometric view of a gaming machine with curved display.

FIG. 2 is a right isometric view of the gaming machine with curved display shown in FIG. 1.

FIG. 3 is a front view of the gaming machine with curved display shown in FIG. 1.

FIG. 4 is a right side view of the gaming machine with curved display shown in FIG. 1.

FIG. 5 is a back view of the gaming machine with curved display shown in FIG. 1.

FIG. 6 is a left side view of the gaming machine with curved display shown in FIG. 1.

FIG. 7 is a top view of the gaming machine with curved display shown in FIG. 1; and,

FIG. 8 is a bottom view of the gaming machine with curved display shown in FIG. 1.

The broken lines are included for the purpose of illustrating unclaimed portions of the gaming machine with curved display, and form no part of the claimed design.

**1 Claim, 5 Drawing Sheets**

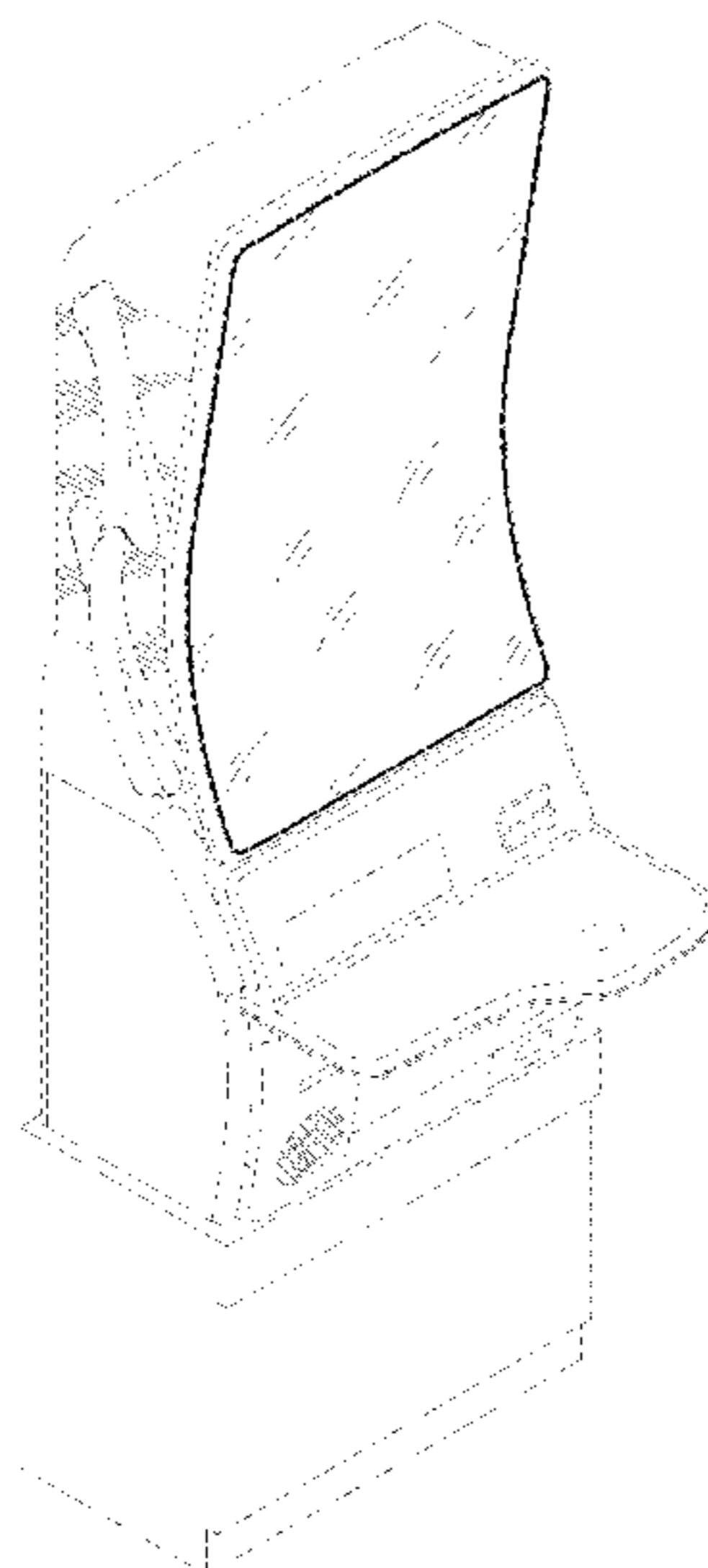

(58) **Field of Classification Search**  
 USPC ..... D14/439, 432, 450, 128, 375; 463/28,  
 463/13, 11, 16, 20, 25, 31, 46, 23, 30, 17,  
 463/36, 29, 42, 34, 32, 35, 19, 21, 22;  
 273/292, 203, 138.2, 143 R, 142 R, 138.1;  
 D19/60; D16/226; D8/336, 331, 334;  
 D26/141  
 CPC ..... G07F 17/32; G07F 17/34; G07F 17/3211;  
 G07F 17/3244; G07F 17/3267  
 See application file for complete search history.

(56) **References Cited**

U.S. PATENT DOCUMENTS

D238,379 S	1/1976	Miller	5,516,103 A	5/1996	Lawlor et al.
3,943,282 A *	3/1976	Muntz ..... H04N 9/3141 348/783	5,522,641 A	6/1996	Infanti
4,046,419 A	9/1977	Schmitt	5,524,887 A	6/1996	Trudeau et al.
D264,485 S	5/1982	Kitchen	5,533,726 A	7/1996	Nordman et al.
4,372,557 A	2/1983	Del Principe et al.	5,542,748 A	8/1996	Barile
4,373,725 A	2/1983	Ritchie	D376,391 S	12/1996	Okumura
D275,772 S	10/1984	Akopian et al.	5,580,052 A	12/1996	Popadiuk et al.
D280,835 S	10/1985	Berge et al.	5,632,482 A	5/1997	Anghelo
D280,836 S	10/1985	Ludzia et al.	D380,014 S	6/1997	Yang
4,606,545 A	8/1986	Ritchie	5,655,965 A	8/1997	Takemoto et al.
4,705,274 A	11/1987	Lubeck	5,664,777 A	9/1997	Nordman et al.
4,840,343 A	6/1989	Gasser	5,669,818 A	9/1997	Thorner et al.
4,861,037 A	8/1989	Oursler	5,678,886 A	10/1997	Infanti
4,930,117 A	5/1990	Huggins	5,697,612 A	12/1997	Piotrowski et al.
4,981,298 A	1/1991	Lawlor et al.	5,704,835 A	1/1998	Dietz, II
D315,110 S	3/1991	Slater	5,707,059 A	1/1998	Sullivan et al.
5,015,189 A	5/1991	Wenzinger	5,720,480 A	2/1998	Lawlor et al.
D318,660 S	7/1991	Weber	D395,463 S	6/1998	Scott et al.
5,074,558 A	12/1991	Bleich et al.	5,762,617 A	6/1998	Infanti
5,083,738 A	1/1992	Infanti	5,791,731 A	8/1998	Infanti
5,091,677 A	2/1992	Bleich et al.	5,806,851 A	9/1998	Gomez et al.
5,102,192 A	4/1992	Barile, Sr.	5,820,460 A	10/1998	Fulton
5,110,120 A	5/1992	Smolucha	5,833,236 A	11/1998	Oursler et al.
5,114,112 A	5/1992	Infanti	D405,473 S	2/1999	Tikhonski et al.
5,120,058 A	6/1992	Trudeau et al.	D407,759 S	4/1999	Isetani et al.
5,123,647 A	6/1992	Lawlor et al.	D408,366 S	4/1999	Popadiuk
5,143,055 A	9/1992	Eakin	5,890,715 A	4/1999	Gomez et al.
5,149,094 A	9/1992	Tastad	5,899,454 A	5/1999	Eddy et al.
D333,164 S	2/1993	Kraft et al.	5,924,690 A	7/1999	Kopera et al.
5,193,807 A	3/1993	Schilling et al.	5,934,672 A	8/1999	Sines et al.
5,195,746 A	3/1993	Boyd et al.	5,938,195 A	8/1999	Anghelo et al.
D335,150 S	4/1993	Biagi et al.	5,944,309 A	8/1999	Popadiuk et al.
5,226,653 A	7/1993	Bil et al.	D417,145 S	11/1999	McLaughlin
5,232,191 A	8/1993	Infanti	5,984,782 A	11/1999	Inoue
5,290,034 A	3/1994	Hineman	6,000,697 A	12/1999	Popadiuk et al.
5,297,793 A	3/1994	DeMar et al.	D419,201 S	1/2000	de Haas
5,316,303 A	5/1994	Trudeau et al.	D419,606 S	1/2000	Toriyama
5,322,283 A	6/1994	Ritchie et al.	6,036,188 A	3/2000	Gomez et al.
5,326,104 A	7/1994	Pease et al.	6,047,962 A	4/2000	Popadiuk
5,350,174 A	9/1994	Ritchie et al.	6,047,963 A	4/2000	Pierce et al.
D351,869 S	10/1994	Rothschild et al.	D424,122 S	5/2000	Dickenson et al.
5,351,954 A	10/1994	Oursler et al.	6,071,190 A	6/2000	Weiss et al.
5,357,104 A	10/1994	Bleich	D428,062 S	7/2000	Hayashi
5,358,241 A	10/1994	Anghelo et al.	6,089,663 A	7/2000	Hill
5,358,242 A	10/1994	Trudeau et al.	6,102,394 A	8/2000	Wurz et al.
5,358,243 A	10/1994	Eddy et al.	6,113,097 A	9/2000	Krutsch et al.
D352,738 S	11/1994	Anghelo et al.	6,117,010 A	9/2000	Canterbury et al.
5,383,663 A	1/1995	Anghelo et al.	6,120,021 A	9/2000	Piotrowski et al.
5,405,144 A	4/1995	Ritchie et al.	6,129,353 A	10/2000	DeMar et al.
5,409,296 A	4/1995	Barile	6,129,355 A	10/2000	Hahn et al.
5,411,257 A	5/1995	Fulton	6,135,449 A	10/2000	Cornell et al.
5,415,402 A	5/1995	Morrison et al.	6,135,562 A	10/2000	Infanti
5,415,403 A	5/1995	Ritchie et al.	6,149,153 A	11/2000	Sheats, Jr.
5,417,423 A	5/1995	Oursler et al.	6,155,565 A	12/2000	Gomez et al.
5,417,425 A	5/1995	Blumberg et al.	6,155,925 A	12/2000	Giobbi et al.
5,437,453 A	8/1995	Hineman	6,158,737 A	12/2000	Cornell et al.
5,465,963 A	11/1995	Pafla, Sr.	6,159,098 A	12/2000	Slomiany et al.
5,472,197 A	12/1995	Gwiasda et al.	6,164,644 A	12/2000	Cornell et al.
5,494,286 A	2/1996	DeMar et al.	6,173,955 B1	1/2001	Perrie et al.
5,507,488 A	4/1996	Eddy et al.	6,199,861 B1	3/2001	Hume et al.
5,511,783 A	4/1996	Popadiuk et al.	D439,931 S	4/2001	Yamaguchi
			6,210,279 B1	4/2001	Dickinson
			6,224,482 B1	5/2001	Bennett
			6,227,614 B1	5/2001	Rubin
			6,227,970 B1	5/2001	Shimizu et al.
			D443,313 S	6/2001	Brettschneider
			D446,252 S	8/2001	Yamaguchi
			6,283,546 B1	9/2001	Hill
			6,290,229 B1	9/2001	Perez
			D450,094 S	11/2001	Hedrick et al.
			6,334,612 B1	1/2002	Wurz et al.
			6,354,660 B1	3/2002	Friedrich
			D459,402 S	6/2002	Wurz et al.
			6,422,670 B1	7/2002	Hedrick et al.
			6,422,941 B1	7/2002	Thorner et al.
			6,439,993 B1	8/2002	O'Halloran
			D463,504 S	9/2002	Stephan
			D464,377 S	10/2002	Wurz et al.
			D465,813 S	11/2002	Randall

(56)

References Cited

U.S. PATENT DOCUMENTS

D466,160 S	11/2002	Hirato et al.	7,503,849 B2	3/2009	Hornik et al.	
D467,977 S	12/2002	Gatto et al.	D590,025 S	4/2009	Fiore	
D468,364 S	1/2003	Beadell et al.	D594,068 S	6/2009	Hsu	
6,530,842 B1	3/2003	Wells et al.	D596,678 S	7/2009	Myers	
6,530,872 B2	3/2003	Freshland et al.	D599,365 S	9/2009	Brown et al.	
6,572,187 B2	6/2003	Laufer	D599,858 S *	9/2009	Lesley .....	D21/370
6,589,114 B2	7/2003	Rose	D599,859 S	9/2009	Lesley et al.	
6,609,972 B2	8/2003	Seelig et al.	D599,860 S	9/2009	Lesley et al.	
6,616,142 B2	9/2003	Adams	D601,638 S	10/2009	Palmisano	
6,620,047 B1	9/2003	Alcorn et al.	D604,368 S	11/2009	Lesley et al.	
D481,078 S	10/2003	Stephan	7,628,693 B2	12/2009	Thomas	
6,646,695 B1	11/2003	Gauselmann	7,666,085 B2	2/2010	Vorias et al.	
6,652,378 B2	11/2003	Cannon et al.	7,686,689 B2	3/2010	Thomas	
D483,075 S	12/2003	Kang	D613,802 S	4/2010	Meyers et al.	
D484,548 S	12/2003	Munoz et al.	D615,598 S	5/2010	McComb et al.	
D485,583 S	1/2004	Porto	7,713,119 B2	5/2010	Pacey et al.	
6,715,756 B2	4/2004	Inoue	D622,780 S	8/2010	Lesley et al.	
6,729,618 B1	5/2004	Koenig et al.	D622,781 S	8/2010	Lesley et al.	
D492,363 S	6/2004	Seelig et al.	D622,782 S	8/2010	Chudek et al.	
D492,364 S	6/2004	Seelig et al.	D626,182 S	10/2010	Cole et al.	
D492,365 S	6/2004	Munoz et al.	D626,183 S	10/2010	Cole et al.	
D492,676 S	7/2004	Monson et al.	7,811,167 B2	10/2010	Giobbi et al.	
D493,843 S	8/2004	Jackson, Sr. et al.	D631,060 S	1/2011	Flik et al.	
D493,846 S	8/2004	Seelig et al.	D631,100 S	1/2011	Palmisano	
D495,754 S	9/2004	Wurz et al.	D633,950 S	3/2011	Terpstra et al.	
D495,755 S	9/2004	Wurz et al.	D637,238 S	5/2011	O'Keene et al.	
D498,267 S	11/2004	Crouch	D637,652 S	5/2011	Tahara et al.	
D500,098 S	12/2004	Doi	7,938,728 B2	5/2011	Vetter et al.	
6,880,825 B2	4/2005	Seelig et al.	7,955,176 B2	6/2011	Tastad et al.	
D505,162 S	5/2005	Bristol et al.	D641,047 S	7/2011	Tahara et al.	
D508,268 S	8/2005	Hanchar et al.	7,976,393 B2	7/2011	Haga et al.	
D508,269 S	8/2005	Wichinsky	7,985,139 B2	7/2011	Lind et al.	
D508,719 S	8/2005	de Haas	8,002,424 B2	8/2011	Hwang et al.	
D508,961 S	8/2005	Gatto et al.	8,002,626 B2	8/2011	Englman	
D509,254 S	9/2005	Rasmussen et al.	D646,336 S *	10/2011	Kelly .....	D21/329
D509,255 S	9/2005	Bristol et al.	D646,337 S *	10/2011	Kelly .....	D21/329
D512,105 S	11/2005	Chitrapongse et al.	D646,691 S	10/2011	Thai et al.	
D513,511 S	1/2006	Decombe	D649,605 S	11/2011	Terpstra et al.	
D515,144 S	2/2006	Boyd	D651,608 S	1/2012	Allen et al.	
6,997,810 B2	2/2006	Cole	8,152,623 B2	4/2012	Fiden	
D520,504 S	5/2006	Martin	8,162,740 B2	4/2012	Aoki	
7,063,615 B2	6/2006	Alcorn et al.	8,216,061 B2	7/2012	Pacey	
7,108,237 B2	9/2006	Gauselmann	8,267,764 B1	9/2012	Aoki et al.	
D531,677 S	11/2006	Mallory et al.	D669,076 S	10/2012	Haller	
7,184,277 B2	2/2007	Beirne	8,292,451 B2	10/2012	Hwang et al.	
D537,885 S	3/2007	Gadda et al.	8,303,420 B2	11/2012	Chudek et al.	
D539,854 S	4/2007	Luciano et al.	8,305,743 B2	11/2012	Wu et al.	
D540,398 S	4/2007	Gadda et al.	8,323,114 B2	12/2012	Burak et al.	
D546,893 S	7/2007	Yamashita	D673,620 S	1/2013	Johnson et al.	
7,247,098 B1	7/2007	Bradford et al.	8,353,755 B2	1/2013	Vann et al.	
D548,801 S	8/2007	Groswirt	8,371,920 B2	2/2013	Gomez et al.	
D549,785 S	8/2007	Luciano, Jr. et al.	8,371,927 B2	2/2013	Englman	
7,267,612 B2	9/2007	Alcorn et al.	8,371,928 B2	2/2013	Englman et al.	
D554,710 S	11/2007	Malone et al.	8,376,832 B2	2/2013	O'Connor et al.	
D556,765 S	12/2007	Evans et al.	D678,955 S	3/2013	Lesley et al.	
D557,748 S	12/2007	Jumper	D678,956 S	3/2013	Lesley et al.	
D559,328 S	1/2008	Rasmussen et al.	D678,957 S	3/2013	Cesaroni et al.	
D559,917 S	1/2008	Cole	D678,958 S	3/2013	Cesaroni et al.	
D560,724 S *	1/2008	Johnson .....	D681,130 S *	4/2013	Lesley .....	D21/385
D560,725 S *	1/2008	Johnson .....	8,430,756 B2	4/2013	McComb et al.	
D563,326 S	3/2008	Patel et al.	D682,948 S *	5/2013	Cesaroni .....	D21/385
D563,481 S	3/2008	Looks et al.	D685,033 S *	6/2013	Wudtke .....	D21/370
D564,600 S	3/2008	Greenberg et al.	D691,665 S	10/2013	Chudek	
D564,601 S	3/2008	Strahinic et al.	D691,666 S *	10/2013	Lesley .....	D21/370
D566,197 S	4/2008	Greenberg et al.	D693,343 S	11/2013	Haller	
D569,863 S	5/2008	Feldstein et al.	D697,558 S	1/2014	Myers et al.	
D572,314 S	7/2008	Vallejo et al.	D704,273 S	5/2014	Chudek	
D573,417 S *	7/2008	Osbourn .....	D704,275 S *	5/2014	Lesley .....	D21/370
D578,168 S	10/2008	Looks et al.	D706,741 S *	6/2014	Myers .....	D14/172
D581,983 S	12/2008	Bergstrom	D707,646 S *	6/2014	Kim .....	D14/138 G
RE40,625 E	1/2009	Wurz et al.	D712,975 S *	9/2014	Lesley .....	D21/369
7,479,066 B2	1/2009	Emori	D713,811 S *	9/2014	Isaacs .....	D14/138 AA
D587,272 S	2/2009	Morrow et al.	D714,269 S *	9/2014	Lee .....	D14/248
D587,319 S	2/2009	Moises Deiab	D714,270 S *	9/2014	Lee .....	D14/248
RE40,671 E	3/2009	Wurz et al.	D714,271 S *	9/2014	Lee .....	D14/248
			D714,875 S	10/2014	Wudtke et al.	
			D715,364 S	10/2014	Wudtke et al.	
			D716,246 S *	10/2014	Yun .....	D14/138 R
			D719,615 S *	12/2014	Inoue .....	D21/370

(56)

References Cited

U.S. PATENT DOCUMENTS

D719,616 S \* 12/2014 Inoue ..... D21/370  
 8,982,545 B2 3/2015 Kim et al.  
 D726,140 S \* 4/2015 Park ..... D14/138 R  
 D730,993 S 6/2015 Castro et al.  
 D733,088 S \* 6/2015 Garneau ..... D14/172  
 D736,751 S \* 8/2015 Lee ..... D14/248  
 D736,752 S \* 8/2015 Lee ..... D14/248  
 D740,888 S \* 10/2015 DePalma ..... D21/370  
 D742,974 S \* 11/2015 Lesley ..... D21/369  
 D742,975 S \* 11/2015 Myers ..... D21/370  
 D744,579 S \* 12/2015 Cope ..... D16/241  
 D747,718 S \* 1/2016 Drabant ..... D14/371  
 D760,846 S 7/2016 Castro et al.  
 D762,613 S \* 8/2016 Garneau ..... D14/172  
 RE46,169 E \* 10/2016 Kelly ..... G07F 17/34  
 D770,406 S \* 11/2016 Fleming, Jr. .... D14/125  
 D786,242 S \* 5/2017 Ho ..... D14/127  
 2002/0041069 A1 4/2002 Steelman  
 2003/0122973 A1 7/2003 Huang  
 2004/0018877 A1 1/2004 Tastad et al.  
 2004/0029631 A1 2/2004 Duhamel  
 2004/0053662 A1 3/2004 Pacey  
 2005/0014547 A1 1/2005 Gomez et al.  
 2006/0009284 A1 1/2006 Schwartz et al.  
 2006/0034042 A1 2/2006 Hisano et al.  
 2006/0079316 A1 4/2006 Flemming et al.  
 2006/0131810 A1 6/2006 Nicely  
 2006/0183553 A1 8/2006 Kiriyama et al.  
 2006/0199638 A1 9/2006 Walker et al.  
 2006/0281559 A1 12/2006 Luciano  
 2006/0287111 A1 12/2006 Mitchell et al.  
 2008/0039213 A1 2/2008 Cornell et al.  
 2008/0051202 A1 2/2008 Lube  
 2009/0174996 A1 7/2009 Park  
 2010/0053231 A1 3/2010 Park  
 2012/0122569 A1 5/2012 Kowolik et al.  
 2012/0168058 A1 7/2012 Kim et al.  
 2013/0180653 A1 7/2013 Kim et al.  
 2013/0278875 A1 10/2013 Kim et al.  
 2013/0321373 A1 \* 12/2013 Yoshizumi ..... G09G 5/00  
 345/211  
 2014/0055696 A1 2/2014 Lee et al.  
 2014/0092356 A1 4/2014 Ahn et al.  
 2014/0176856 A1 6/2014 Lee et al.  
 2014/0226111 A1 8/2014 Kim  
 2014/0226112 A1 8/2014 Kim  
 2014/0354938 A1 12/2014 Kim  
 2014/0368782 A1 12/2014 Kim et al.  
 2014/0375963 A1 12/2014 Bishop  
 2015/0000823 A1 1/2015 Kim et al.  
 2015/0036073 A1 2/2015 Im et al.  
 2015/0116621 A1 4/2015 Park et al.  
 2015/0116625 A1 4/2015 Hwang et al.  
 2015/0301390 A1 10/2015 Kim

FOREIGN PATENT DOCUMENTS

KR 10-1113734 B1 2/2012  
 KR 10-2012-0051630 5/2012  
 KR 10-1268471 B1 6/2013  
 KR 10-1278904 B1 6/2013  
 KR 10-1336677 B1 12/2013  
 KR 10-1381609 B1 4/2014  
 KR 10-1381610 B1 4/2014  
 KR 10-2015-0013987 2/2015  
 KR 10-1539221 B1 7/2015  
 TW 200949775 A 12/2009

OTHER PUBLICATIONS

Product Sheet for “American Eagle,” Eagle Co. Ltd., 1997 (2 pages).

Product Sheet for “Monopoly Chairman of the Board™,” WMS Gaming Inc., 1999 (2 pages).  
 Product Sheet for “American Eagle,” Eagle Co. Ltd., 2000 (2 pages).  
 Product Sheet for “Survivor,” WMS Gaming Inc., 2001 (4 pages).  
 Product Sheet for “ProSLOT® 6000,” Bally Gaming Systems, 2002 (4 pages).  
 Product Sheet for “EVO™ Hybrid,” Bally Gaming Systems, 2002 (4 pages).  
 Product Sheet for “3RV™,” WMS Gaming In., 2002 or earlier (2 pages).  
 Product Sheet for “Miss America,” AC Coin & Slot, 2002 or earlier (2 pages).  
 Product Catalog for Ainsworth Game Technology Ltd, date estimated as early as 2007 (6 pages).  
 Product Sheet for “Ultrapin™,” Global VR, 2007 (1 pages).  
 Brochure for “Virtual Pinball,” Tab-Austria, 2007 (8 pages).  
 Catalog for Atronic®-Spielo®, date estimated as early as 2008 (2 pages).  
 Product Catalog for “Alpha Elite™,” Bally Technologies, date estimated as early as 2008-2009 (2 pages).  
 Cabinet Brochure for Hydako Co., date estimated as early as 2009 (1 page).  
 Product Catalog for Bally Technologies, date estimated as early as 2010 (2 pages).  
 Fall & Winter Catalog for Aristocrat, date estimated as early as 2010-2011 (7 pages).  
 Catalog for “Your Partner Innovation,” Bally Technologies, date estimated as early as 2011 (4 pages).  
 Photonics industry and Technology Development Association (PIDA); “E-Paper Shows Potential at Creating a Paperless Haven”; OptoLink Magazine, 3 Quarter 2008; pp. 8-11 (4 pages).  
 AU Optronics Corp.; News Center. “AUO Announces Multiple Upcoming Innovations”; Oct. 27, 2008; retrieved from <<http://www.auo.com/?sn=107&lang=en-US&c=10&n=363>> on Mar. 3, 2017 (2 pages).  
 DigiTimes Inc.; “FPD China 2009: AUO 8.9-inch convex display panel”; Mar. 12, 2009; retrieved from <<http://www.digitimes.com/photogallery/showphoto.asp?ID=3376>> on Mar. 3, 2017 (3 pages).  
 Gizmodo.com; “AUO Curved Displays, Ultra Thin LCDs on the Way”; May 20, 2008; retrieved from <<http://gizmodo.com/392248/auo-curved-displays-ultra-thin-lcds-on-the-way>> on Mar. 3, 2017 (2 pages).  
 PC World; “AU Optronics Shows off Curved LCD Screen”; May 20, 2008; retrieved from <<http://www.pcworld.com/article/146083/article.amp.html>> on Mar. 3, 2017 (3 pages).  
 DailyTech; “AUO Shows Off Curved Display and Touch Screen”; May 23, 2008; retrieved from <<http://www.dailytech.com/AUO+Shows+Off+Curved+Display+and+Touch+Screen+Tech+article11845.htm>> on Mar. 3, 2017 (2 pages).  
 OLED-Info; “LG Phillips LCD Develops 14.3-Inch Color E-Paper Display”; Jan. 4, 2008; retrieved from <[http://www.oled-info.com/lg/lg\\_philips\\_lcd\\_develops\\_14\\_3\\_inch\\_color\\_e\\_paper\\_display](http://www.oled-info.com/lg/lg_philips_lcd_develops_14_3_inch_color_e_paper_display)>; (2 pages).  
 NewLaunches.com; “LG Phillips LCD develops world’s highest resolution 14.3-inch flexible color E-paper display!”; Jan. 3, 2008; retrieved from <[http://newlaunches.com/archives/lgphillips\\_lcd\\_develops\\_worlds\\_highest\\_resolution\\_143inch\\_flexible\\_color\\_epaper\\_display.php](http://newlaunches.com/archives/lgphillips_lcd_develops_worlds_highest_resolution_143inch_flexible_color_epaper_display.php)> (4 pages).  
 Wood, M., Major, C., Carr, V. eds.; “Curved Screens: Worth It?” video found at <<http://www.nytimes.com/video/technology/personaltech/10000002788325/curved-screens-worth-it.html>>; New York Times; Mar. 26, 2014.  
 Immersaview; “Why choose a Curved Screen for your Multi-Projector Setup”; Jan. 28, 2016; retrieved from <<https://www.immersaview.com/resources/why-curved/>> (7 pages).  
 Denison; “Why can’t you buy a flat OLED yet? The curve isn’t just about viewing experience”; Digital Trends; Aug. 18, 2013; retrieved from <<http://www.digitaltrends.com/home-theater-why-did-the-us-get-stuck-with-curved-oled/#!zXypT>> (8 pages).  
 Wilcox; “LG, Samsung, and Sony throw TV buyers a curve”; Consumer Reports; Sep. 10, 2013; retrieved from <<http://www.consumerreports.org/cro/news/2013/09/curved-tv-screens/index.htm#>> (1 page).

(56)

**References Cited**

## OTHER PUBLICATIONS

Snider; “Sony tosses latest pitch for curved TV displays”; USA Today; Oct. 15, 2013; retrieved from <<http://www.usatoday.com/story/tech/personal/2013/10/15/new-curved-sony-led-hdtv/2982051/>> (2 pages).

Morrison; “Curved OLED HDTV screens are a bad idea (for now)”; CNET; Jun. 18, 2013; reetrieved from <<https://www.cnet.com/news/curved-oled-hdtv-screens-are-a-bad-idea-for-now/>> (9 pages).

Cohran; “Why Samsung’s curved-screen TV might be a ‘game changer’”; CBS News; Aug. 14, 2013; retrieved from <<http://www.cbsnews.com/news/why-samsungs-curved-screen-tv-might-be-a-game-changer/>> (3 pages).

Kelly; “TV trends at CES: 4K, curves and smart TVs”; CNN; Jan. 8, 2014; retrieved from <<http://www.cnn.com/2014/01/07/tech/gaming-gadgets/ces-television-trends/>> (5 pages).

Manjoo; “TV Makers Are Out of Ideas”; Wall Street Journal; Jan. 8, 2014; retrieved from <<https://www.wsj.com/news/articles/SB100014240527023033938045790308801012230792>> (4 pages).

Daniel; “Curved Monitors—Overview”; Cruved Monitor Test; Aug. 28, 2015; retrieved from <<http://www.curved-monitor-test.de/>> (5 pages).

Matthias; “Curved TV—Overview”; Curved TV Test; Apr. 20, 2016; retrieved from <<http://technikblog.net/fernseher-est/curved-tv/>> (16 pages, in German).

Ljt216; “Flat Screen vs Curved CRTs for Retro Games”; Reddit; Jul. 29, 2015; retrieved from <[https://www.reddit.com/r/gamecollecting/comments/3f25r0/flat\\_screen\\_vs\\_curved\\_crts\\_for\\_retro\\_games/](https://www.reddit.com/r/gamecollecting/comments/3f25r0/flat_screen_vs_curved_crts_for_retro_games/)> (4 pages).

\* cited by examiner

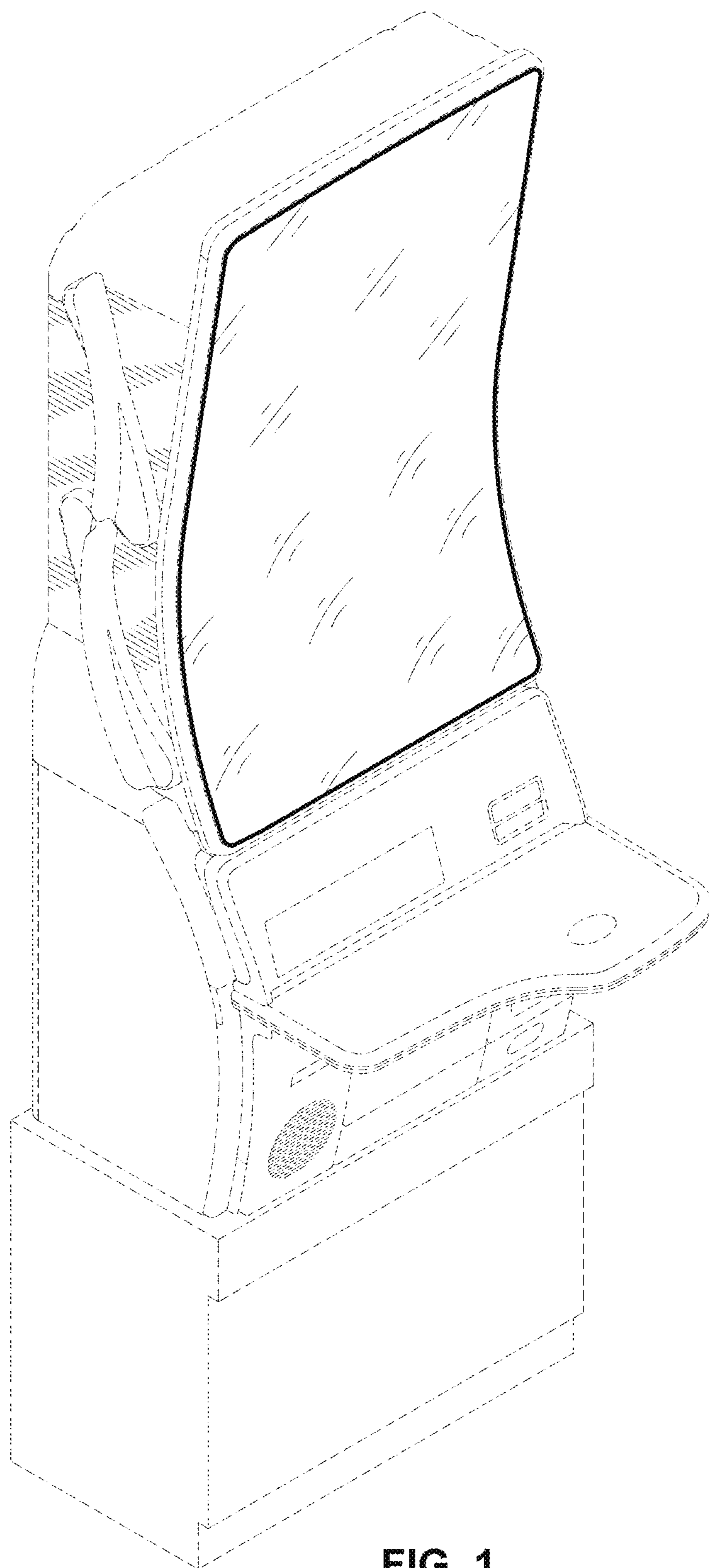

FIG. 1

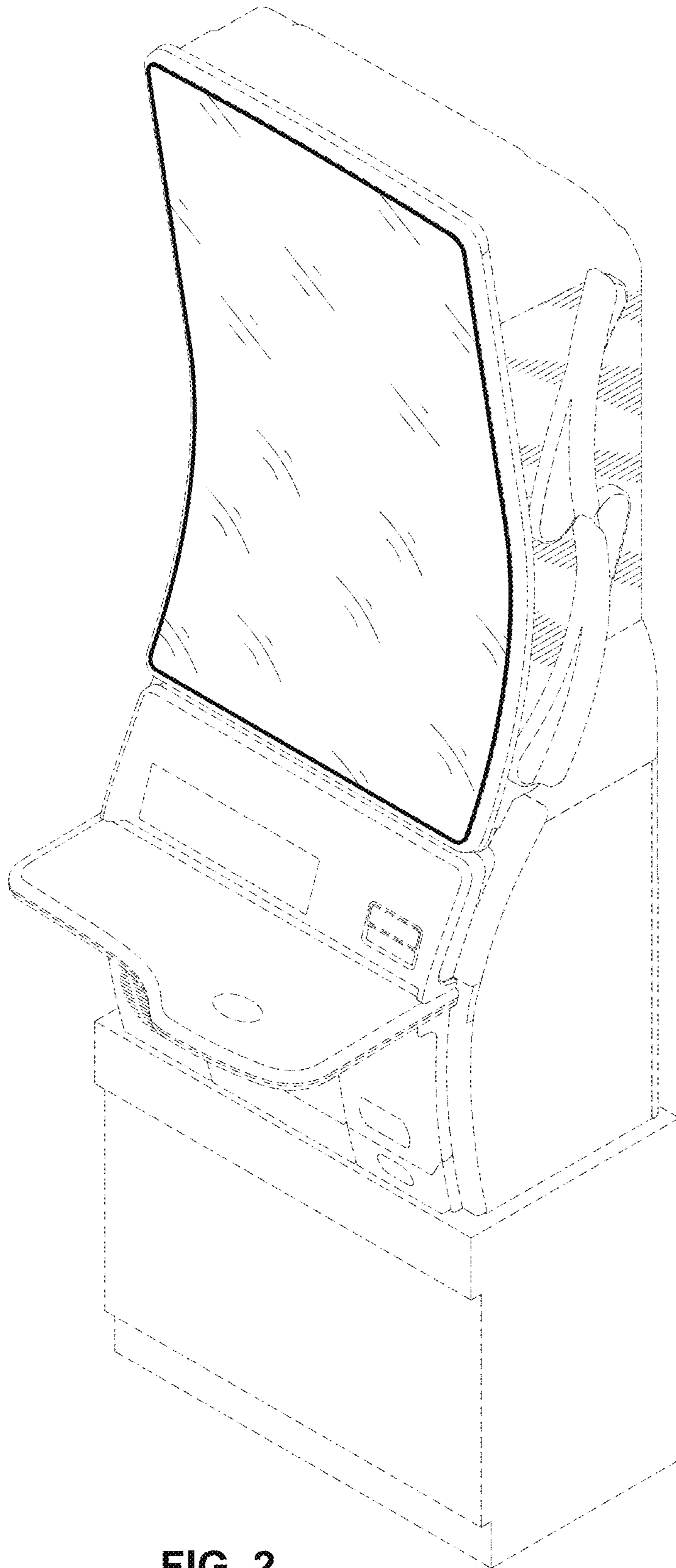

FIG. 2

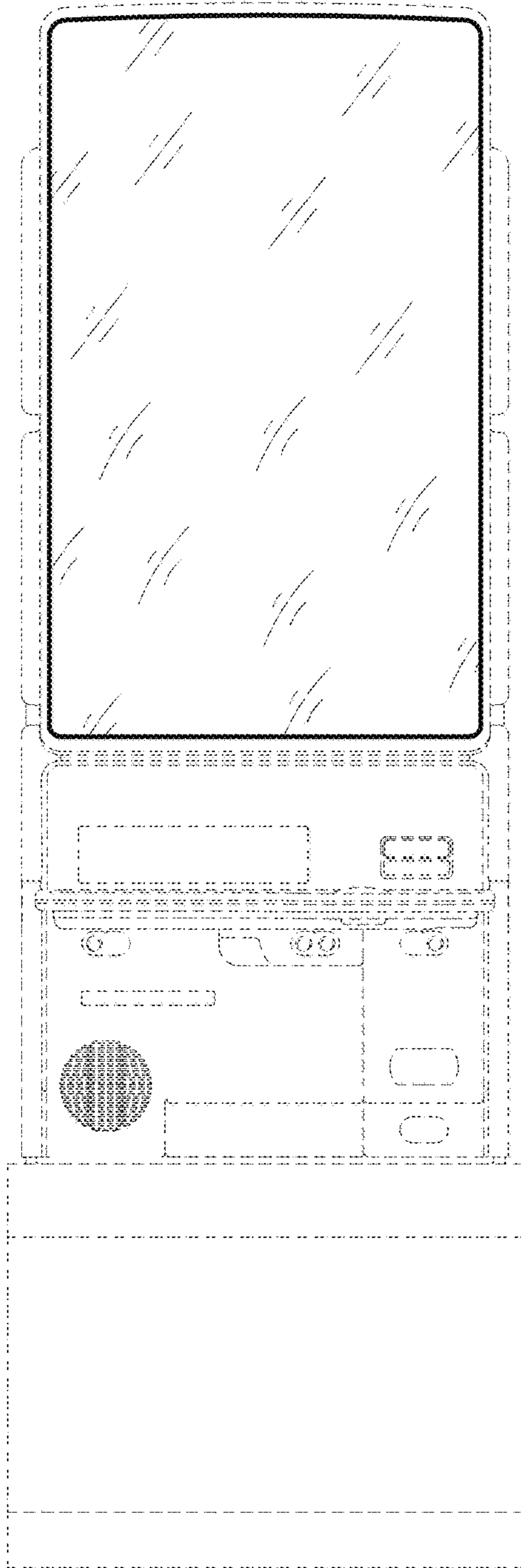

FIG. 3

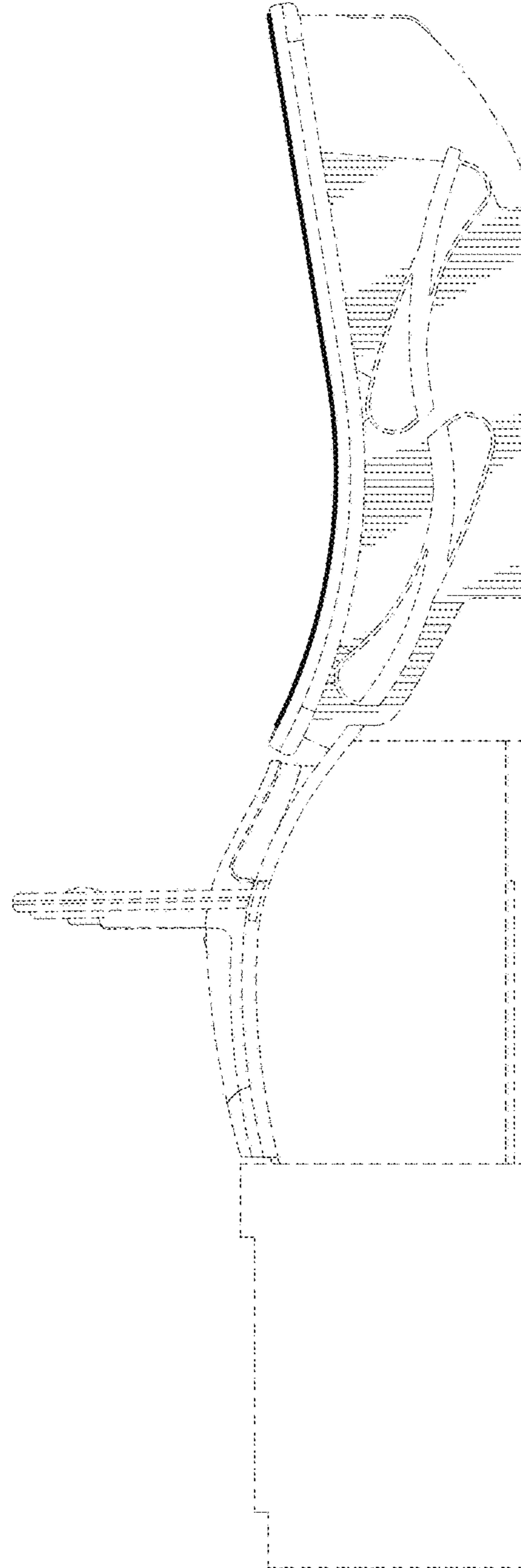

FIG. 4



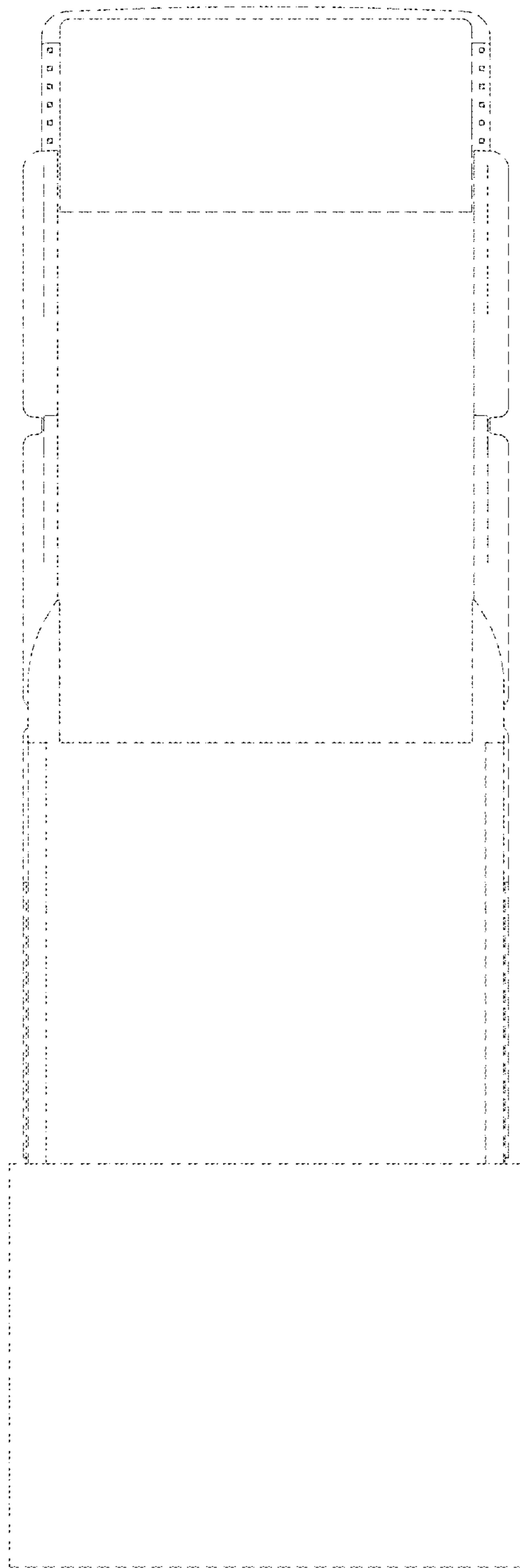

FIG. 5

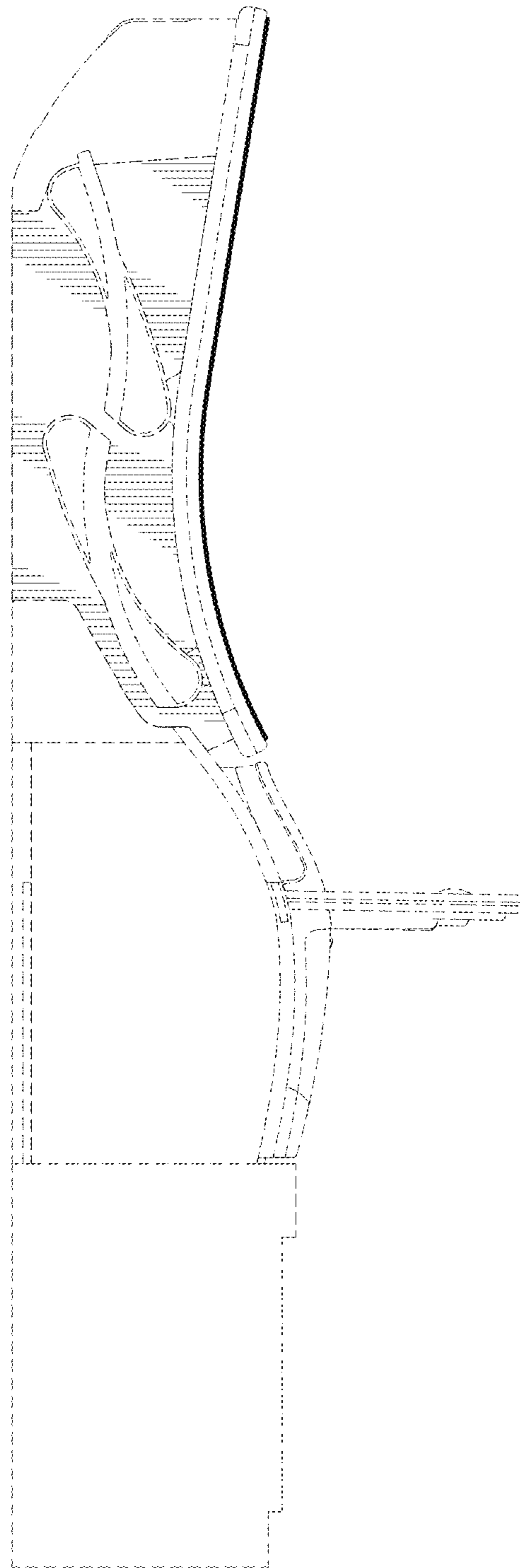

FIG. 6

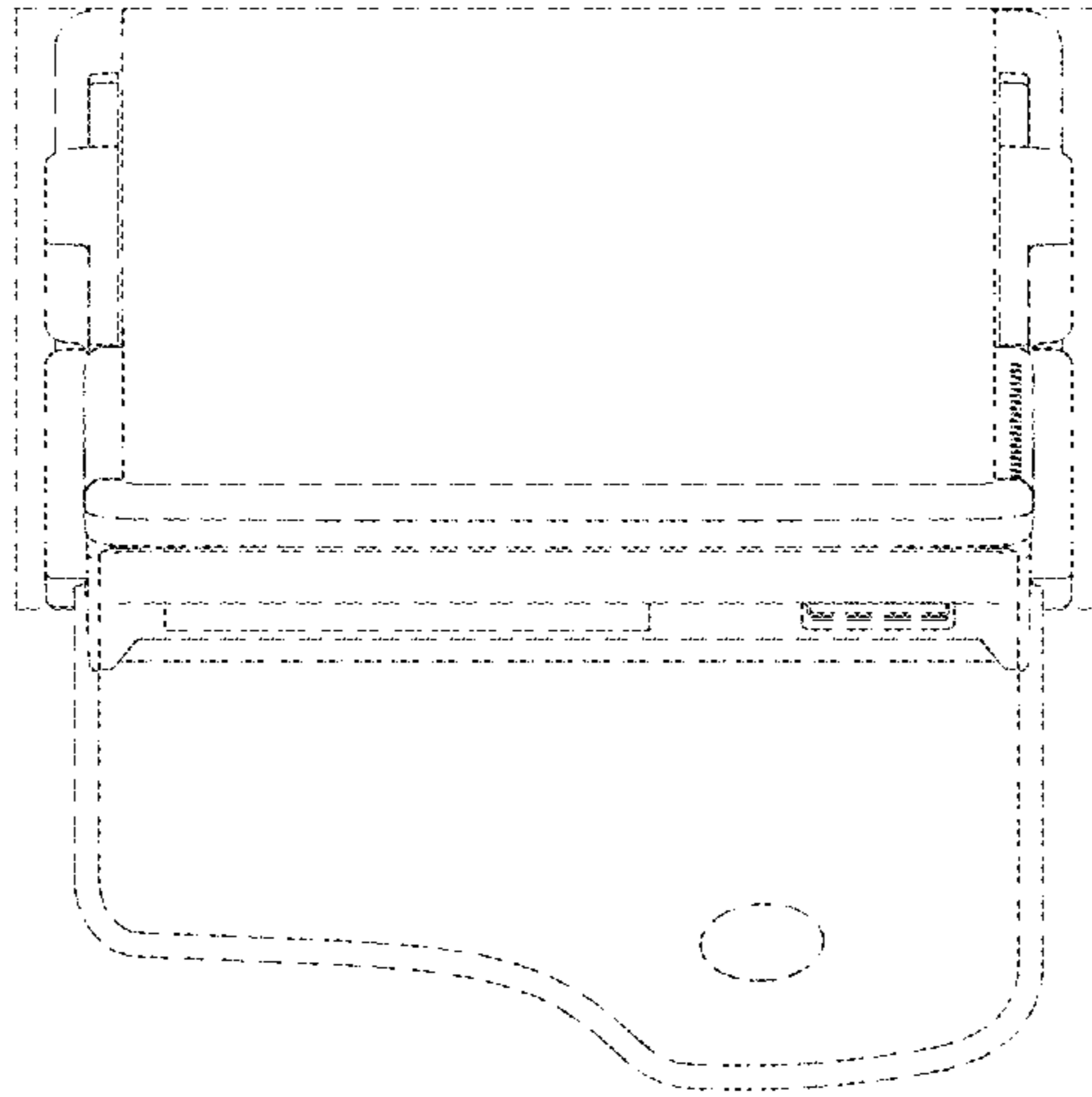

FIG. 7

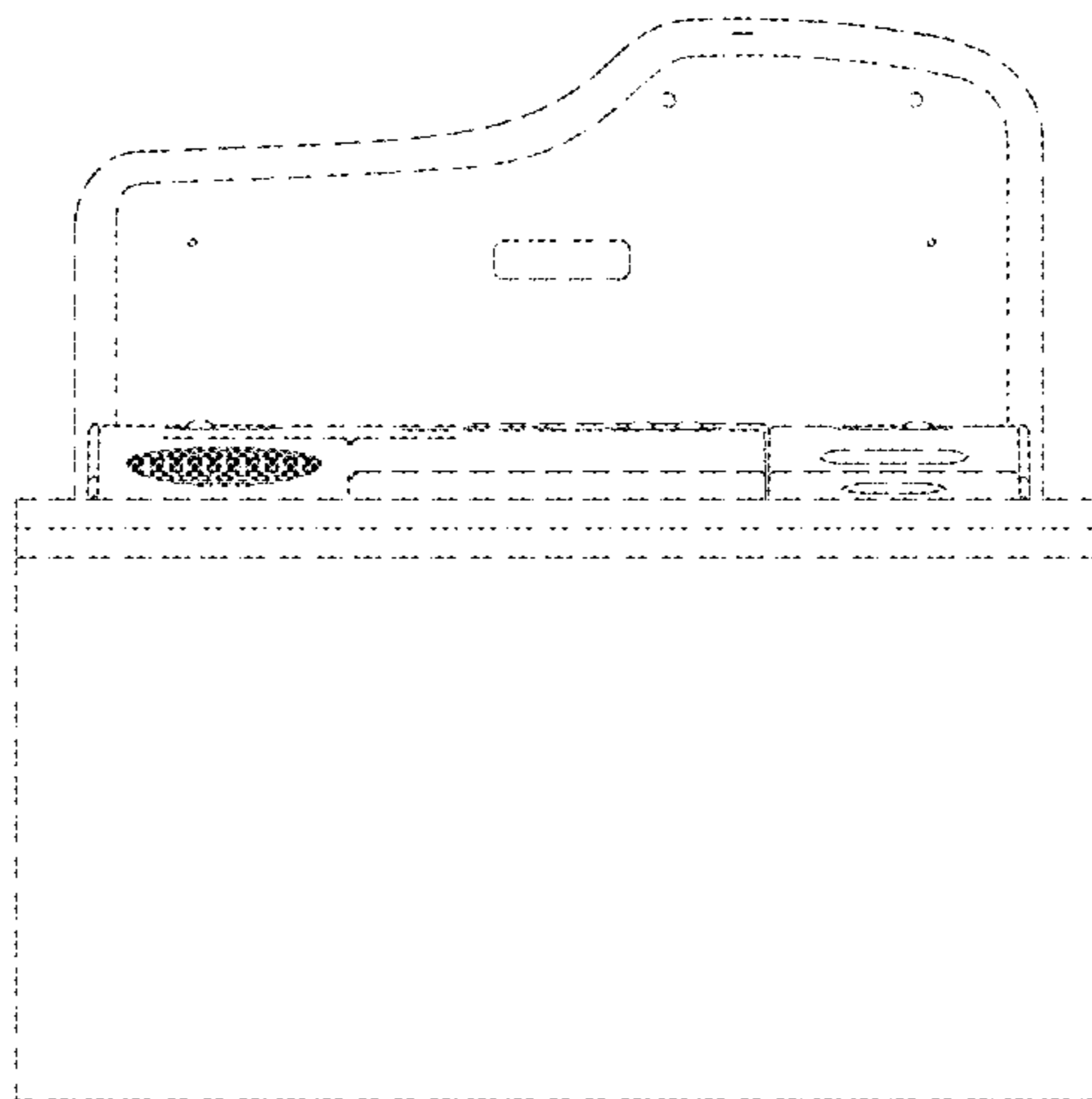

FIG. 8