



US00D812064S

(12) **United States Design Patent** (10) **Patent No.:** **US D812,064 S**
Wengreen (45) **Date of Patent:** **** Mar. 6, 2018**

(54) **MOUNT FOR ELECTRONIC DEVICE**

(71) Applicant: **Innovelis, Inc.**, Sammamish, WA (US)

(72) Inventor: **Eric John Wengreen**, Sammamish, WA (US)

(73) Assignee: **Innovelis, Inc.**, Sammamish, WA (US)

(**) Term: **15 Years**

(21) Appl. No.: **29/597,495**

(22) Filed: **Mar. 17, 2017**

(51) **LOC (11) Cl.** **14-02**

(52) **U.S. Cl.**
USPC **D14/434**; D14/496; D14/238.1

(58) **Field of Classification Search**

USPC ... D14/217, 209.1, 432, 434, 188, 356, 439, D14/447, 454, 251; D8/373; D13/107, D13/108, 146; 248/176.1; 320/109, 320/112-115; 361/679.4, 679.31-679.33, 361/679.41, 679.55; 455/557, 34-351; 710/15, 303; D21/332, 333, 324
CPC F16M 11/02; F16M 11/04; A47F 5/00; A47F 5/10; G06F 1/16; G06F 1/1613
See application file for complete search history.

(56) **References Cited**

U.S. PATENT DOCUMENTS

1,618,573 A 2/1927 Cole
2,584,646 A 2/1952 Wagstaff
3,091,378 A 5/1963 O'Dwyer
D196,542 S 10/1963 Zelnick
3,176,950 A 4/1965 Hittesdorf
3,279,009 A 10/1966 Teasdale
3,294,298 A 12/1966 Danielson
3,477,679 A 11/1969 Lovitz
3,990,617 A 11/1976 Carter
D242,766 S 12/1976 Neece
4,067,532 A 1/1978 Viteretto
4,158,450 A 6/1979 Suzuki

4,467,244 A 8/1984 Dickie
4,519,656 A 5/1985 Raz
D280,466 S 9/1985 Seltzer
D282,034 S 1/1986 Janke
4,602,761 A 7/1986 Carter
4,697,780 A 10/1987 Wenkman
4,746,042 A 5/1988 King
4,771,927 A 9/1988 Ventura
4,815,683 A 3/1989 Ferrante
4,825,590 A 5/1989 Cullinane
4,826,115 A 5/1989 Novitski
4,840,773 A 6/1989 Wade

(Continued)

OTHER PUBLICATIONS

Apple TV, downloaded on Feb. 3, 2014 from <http://www.apple.com/appletv/what-is/>.

(Continued)

Primary Examiner — Prabhakar G Deshmukh

(57) **CLAIM**

The ornamental design for a mount for electronic device, as shown and described.

DESCRIPTION

FIG. 1 is a front, first side, and top perspective view of a mount for electronic device embodying the new design; FIG. 2 is a back, second side, and bottom perspective view thereof; FIG. 3 is a front view thereof; FIG. 4 is a back view thereof; FIG. 5 is a second side view thereof; FIG. 6 is a first side view thereof; FIG. 7 is a top view thereof; and, FIG. 8 is a bottom view thereof. The uniform repeating broken lines depict portions of a mount for electronic device in which the claimed design is embodied and form no part of the claimed design.

1 Claim, 8 Drawing Sheets

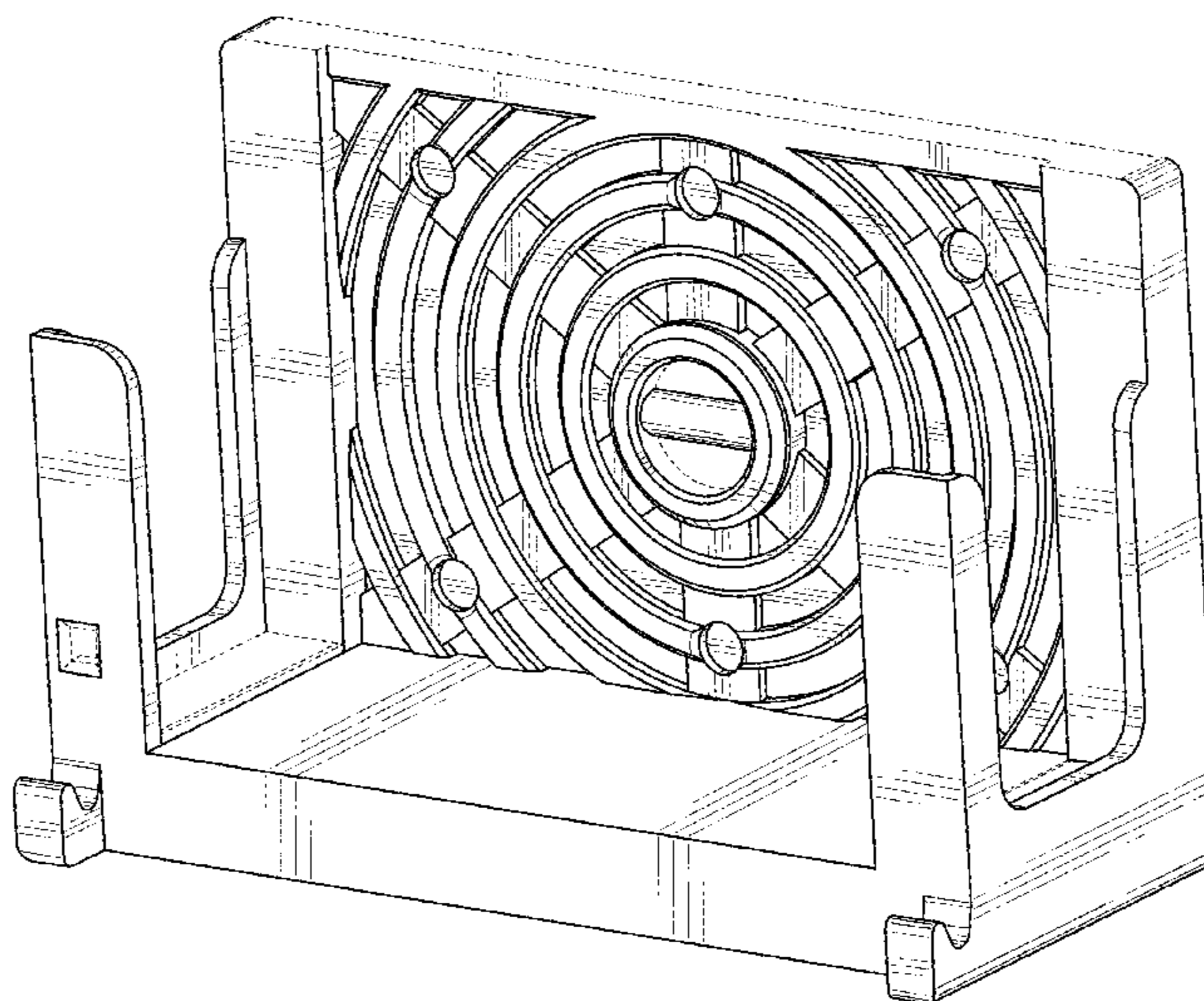

(56)

References Cited

U.S. PATENT DOCUMENTS

4,852,843	A	8/1989	Chandler		D557,266	S	12/2007	Hughes	
4,974,764	A	12/1990	Cantwell		D560,411	S	1/2008	Chung	
D317,157	S	5/1991	Jondelius		D564,529	S	3/2008	Hughes	
5,038,985	A	8/1991	Chapin		D565,399	S	4/2008	Grey	
5,092,395	A	3/1992	Amidzich		D568,889	S	5/2008	Hughes	
5,227,582	A	7/1993	Velasco		7,367,089	B2	5/2008	Cooke	
5,273,690	A	12/1993	McDowell		D570,801	S	6/2008	Allen	
5,297,318	A	3/1994	Adolphson		D586,795	S	2/2009	Richter	
D351,341	S	10/1994	Hung		D592,206	S	5/2009	O'Brien	D12/415
5,385,282	A	1/1995	Chen		D596,172	S	7/2009	Ahlqvist	
5,400,990	A	3/1995	Frankel		D598,945	S	8/2009	Gillespie	
D359,616	S	6/1995	Ishibashi		7,580,255	B2	8/2009	Crooijmans	
D361,335	S	8/1995	Rudkiewicz		D601,000	S	9/2009	Cole	
D361,462	S	8/1995	Newham		D609,030	S	2/2010	Barabas	
D362,663	S	9/1995	Nguyen	D14/434	D610,579	S	2/2010	Behar	
D369,465	S	5/1996	Scheid		D624,949	S	10/2010	Nakayama	
5,535,093	A	7/1996	Noguchi		D625,729	S	10/2010	McNames	
D376,787	S	12/1996	Calfee		D628,611	S	12/2010	Lewis	
5,593,124	A	1/1997	Wang		7,854,420	B2	12/2010	Depay	
5,619,395	A	4/1997	McBride		D633,503	S	3/2011	Bo	
5,619,774	A	4/1997	Perry		7,925,320	B2	4/2011	Pemble	B60R 11/0258 455/550.1
D388,107	S	12/1997	Huckins		7,959,121	B1	6/2011	Barnes	
D390,849	S	2/1998	Richter		7,980,435	B2	7/2011	Tages	
5,850,998	A	12/1998	Parsey		8,041,029	B2	10/2011	Wieggers	F16M 11/14 248/346.03
D407,408	S	3/1999	Hoff		D648,727	S	11/2011	Van Den Nieuwenhuizen	
D409,079	S	5/1999	Sobczynski		D657,362	S	4/2012	Lister	
5,899,371	A	5/1999	Weliver		D660,306	S	5/2012	Voorhees	D14/238.1
D411,542	S	6/1999	Richter		D662,491	S	6/2012	Andre	
5,914,707	A	6/1999	Kono		D667,411	S	9/2012	Kim	
5,961,083	A	10/1999	Hartman		D669,890	S	10/2012	Hopkins	
5,979,724	A	11/1999	Loewenthal		D672,308	S	12/2012	Cobbett	
D420,149	S	2/2000	Hersh		8,322,584	B2	12/2012	Dethmers	
6,039,173	A	3/2000	Crow		D686,629	S	7/2013	Trinh	
D425,353	S	5/2000	Foy		D690,707	S	10/2013	Minn	
6,073,901	A	6/2000	Richter		8,544,805	B2	10/2013	Virgin	
6,102,660	A	8/2000	Lee		D695,748	S	12/2013	Morris	
6,105,923	A	8/2000	Robertson		D700,832	S	3/2014	Ng	
D431,250	S	9/2000	Richter		8,668,179	B2	3/2014	Corn	F16M 13/00 248/181.1
6,163,997	A	12/2000	Deralas		D705,229	S	5/2014	Wengreen	
6,193,546	B1	2/2001	Sadler		D710,340	S	8/2014	Wengreen	
D443,493	S	6/2001	Skeem		D710,363	S	8/2014	Wengreen	
6,275,885	B1	8/2001	Chin		D710,836	S	8/2014	Wengreen	
6,336,615	B1	1/2002	Jeon		D712,239	S	9/2014	Booth	
D456,024	S	4/2002	Richter		D712,906	S	9/2014	Wengreen	
D456,413	S	4/2002	Malson		D713,395	S	9/2014	Godycki	
6,445,290	B1	9/2002	Fingal		D713,399	S	9/2014	Green	
6,485,144	B1	11/2002	Liao		D713,849	S	9/2014	Kirwer	D12/416
D471,547	S	3/2003	Ruohonen		8,847,549	B2	9/2014	Graham	
6,554,527	B1	4/2003	O'Donnell		8,848,113	B2	9/2014	Wengreen	
6,560,983	B1	5/2003	Schimmeyer		D714,793	S	10/2014	Kim	
6,657,868	B1	12/2003	Hsue	G11B 33/128 174/138 G	D716,580	S	11/2014	Wengreen	
6,691,374	B2	2/2004	Coyne		D717,307	S	11/2014	Chun	
6,888,940	B1	5/2005	Deppen		D717,804	S	11/2014	Budge	
D508,605	S	8/2005	Shih-Ming		8,896,768	B1	11/2014	Wengreen	
6,939,641	B2	9/2005	Kincaid		8,934,060	B1	1/2015	Wengreen	
6,983,126	B1	1/2006	Saalman		8,934,061	B1	1/2015	Wengreen	
D518,704	S	4/2006	Miao		8,939,417	B1	1/2015	Wengreen	
7,047,601	B1	5/2006	Vernon-Woods		D723,042	S	2/2015	Lee	
7,067,737	B2	6/2006	Mallen		8,988,616	B2	3/2015	Wengreen	
7,079,384	B2	7/2006	Wang		9,019,698	B2	4/2015	Thiers	H04W 88/02 248/922
7,080,764	B2	7/2006	McNicholas		D729,544	S	5/2015	Wengreen	
7,113,218	B2	9/2006	Battles		D732,939	S	6/2015	Cannaverde	
D529,713	S	10/2006	Guyot		D733,105	S	6/2015	Wengreen	
D529,905	S	10/2006	Richter		D733,542	S	7/2015	Cannaverde	
D530,713	S	10/2006	Richter	D14/253	D733,691	S	7/2015	Wengreen	
D533,175	S	12/2006	Richter		D734,305	S	7/2015	Wengreen	
7,145,603	B2	12/2006	Whitby		D735,174	S	7/2015	Wengreen	
D535,826	S	1/2007	Toghanian		D739,410	S	9/2015	Chun	
D536,239	S	2/2007	Tallman		9,131,195	B2	9/2015	Wengreen	
7,222,762	B2	5/2007	Rees		D742,387	S	11/2015	Xiang	
D545,343	S	6/2007	Braun		D746,599	S	1/2016	Olson	
D547,863	S	7/2007	Heinsch		D749,549	S	2/2016	Wengreen	
D551,008	S	9/2007	Hidalgo		D749,597	S	2/2016	Wengreen	
D553,352	S	10/2007	Allen		D750,633	S	3/2016	Minn	
					D751,563	S	3/2016	Wengreen	

(56)

References Cited

U.S. PATENT DOCUMENTS

D752,415	S	3/2016	Lu	
9,339,112	B2 *	5/2016	Wengreen A47B 97/00
D759,005	S	6/2016	Murakami	
D761,236	S	7/2016	Wengreen	
D763,666	S	8/2016	Wengreen	
D763,835	S	8/2016	Wengreen	
D765,063	S	8/2016	Wengreen	
D765,064	S	8/2016	Wengreen	
D765,646	S	9/2016	Deng	
D765,651	S	9/2016	Liu	
D767,377	S	9/2016	Sekula	
D770,171	S	11/2016	Lai	
D772,217	S	11/2016	Alesi	
D777,167	S	1/2017	Wengreen	
9,543,082	B1	1/2017	Wengreen	
D779,466	S	2/2017	Wengreen	
D795,820	S	8/2017	Wengreen	
2005/0023419	A1	2/2005	Frankel	
2005/0211861	A1	9/2005	Lee	
2005/0236541	A1	10/2005	Chang	
2006/0224575	A1	10/2006	Ostojic	
2007/0097617	A1	5/2007	Searby	
2007/0235609	A1	10/2007	Chun	
2007/0264169	A1	11/2007	Chen	
2008/0078793	A1	4/2008	Brown	
2009/0218454	A1	9/2009	Stanley	
2009/0296997	A1	12/2009	RocheFord	

2010/0270190	A1	10/2010	Howard	
2010/0281671	A1	11/2010	De Vaan	
2010/0288895	A1	11/2010	Shamie	
2010/0314277	A1	12/2010	Murray	
2011/0242439	A1	10/2011	Calderon	
2012/0126081	A1	5/2012	Wengreen	
2012/0127379	A1	5/2012	Wengreen	
2012/0168516	A1	7/2012	Bolger	
2012/0280014	A1	11/2012	Lopez-Apodaca	
2012/0312950	A1	12/2012	Sears	
2014/0061406	A1	3/2014	Chevalier	
2014/0103179	A1	4/2014	Lipke	
2014/0241705	A1	8/2014	Wengreen	
2015/0070835	A1	3/2015	McLean	
2015/0212544	A1	7/2015	Chen	
2015/0305502	A1	10/2015	Wengreen	
2016/0007735	A1	1/2016	Gallup	
2016/0119458	A1	4/2016	Gunther	
2016/0120295	A1	5/2016	Rowley	
2016/0218535	A1	7/2016	Prete	
2016/0234955	A1	8/2016	Wengreen	
2016/0241289	A1	8/2016	Wieth	

OTHER PUBLICATIONS

Hide it Mounts—PS4 Wall Mount, downloaded from <https://www.amazon.com/HIDE-Mounts-Original-Wall-Mount-PlayStation/dp/B00PMLO4YK>, available at least as early as Sep. 8, 2015.

* cited by examiner

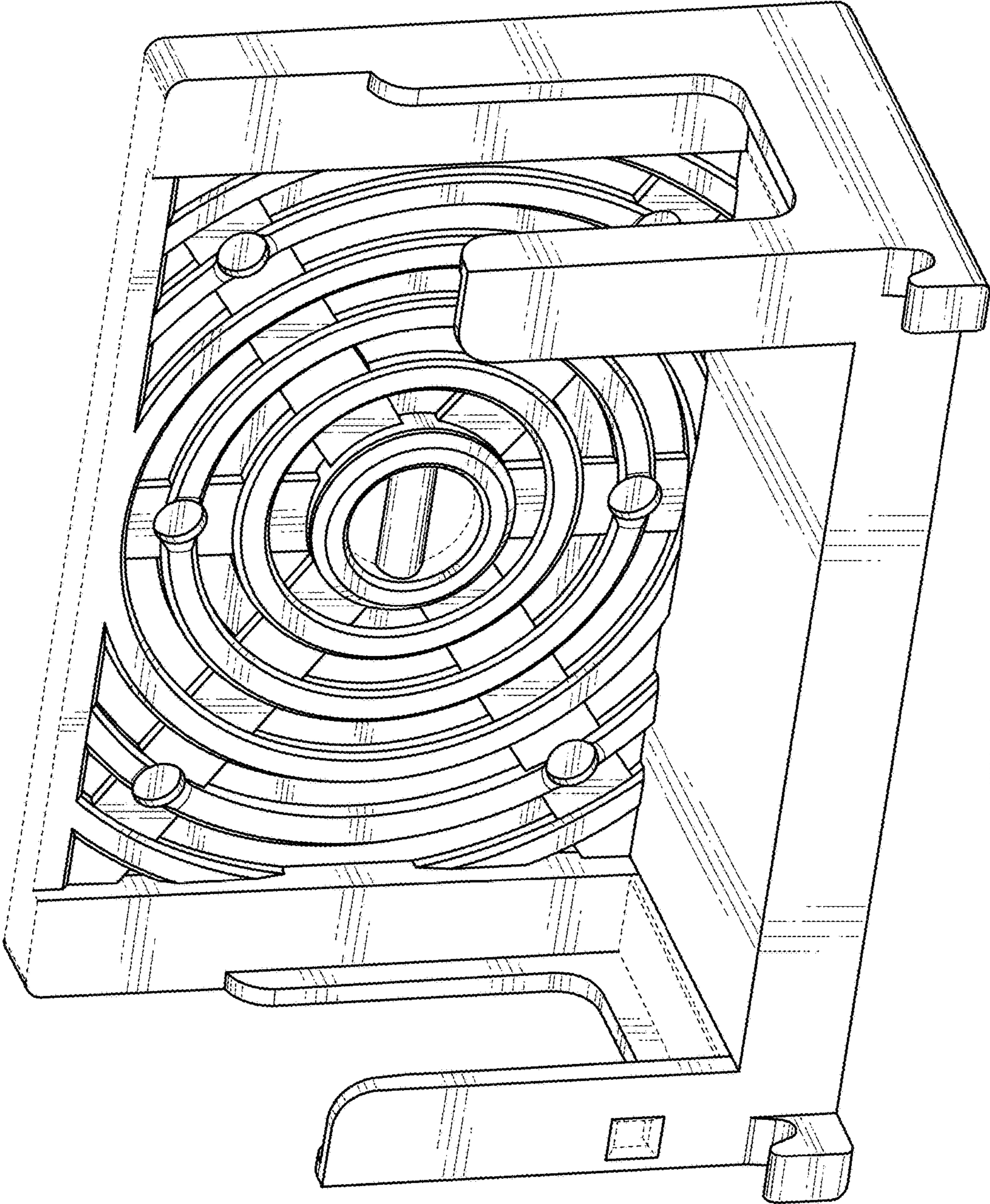

FIG. 1

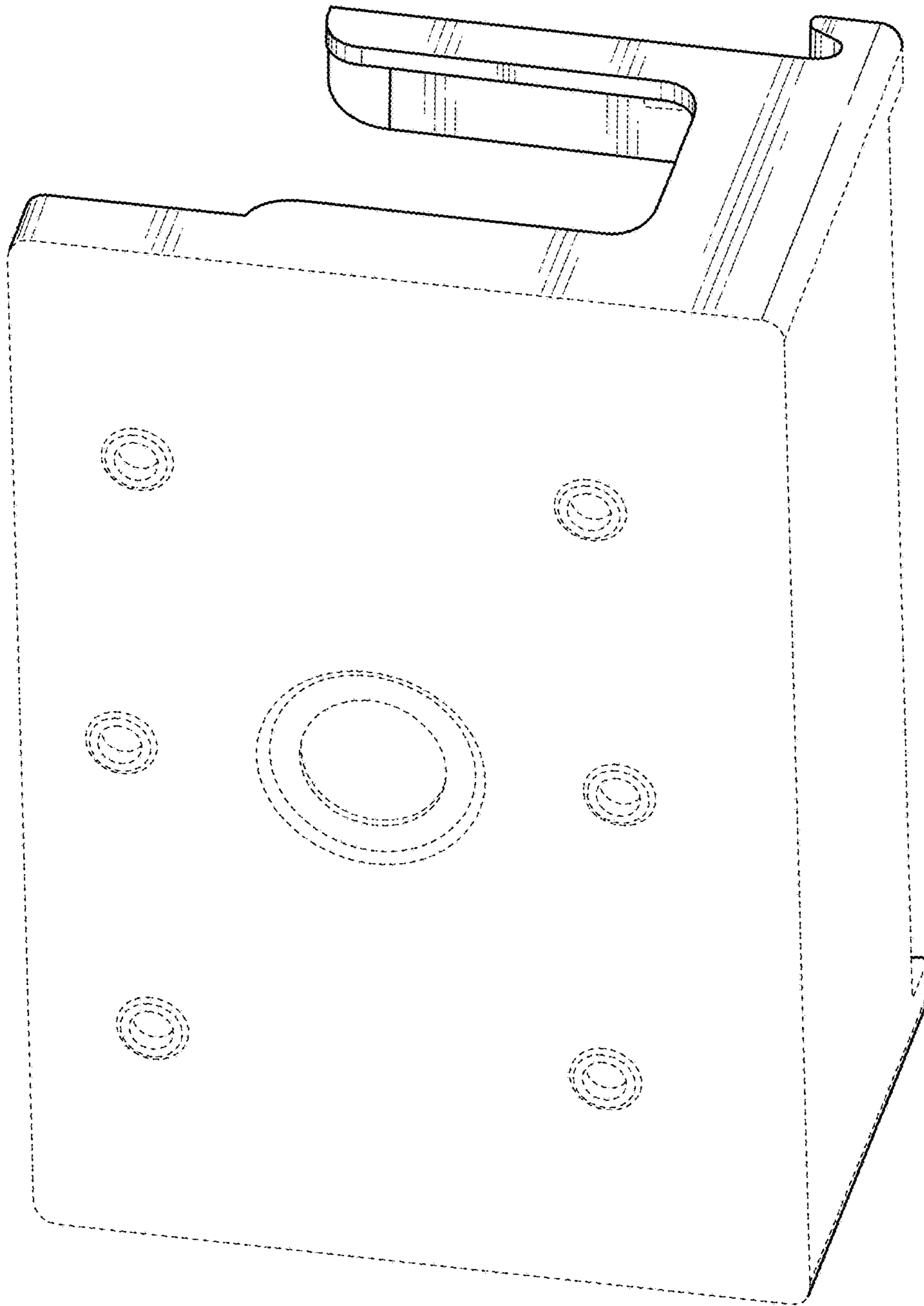

FIG. 2

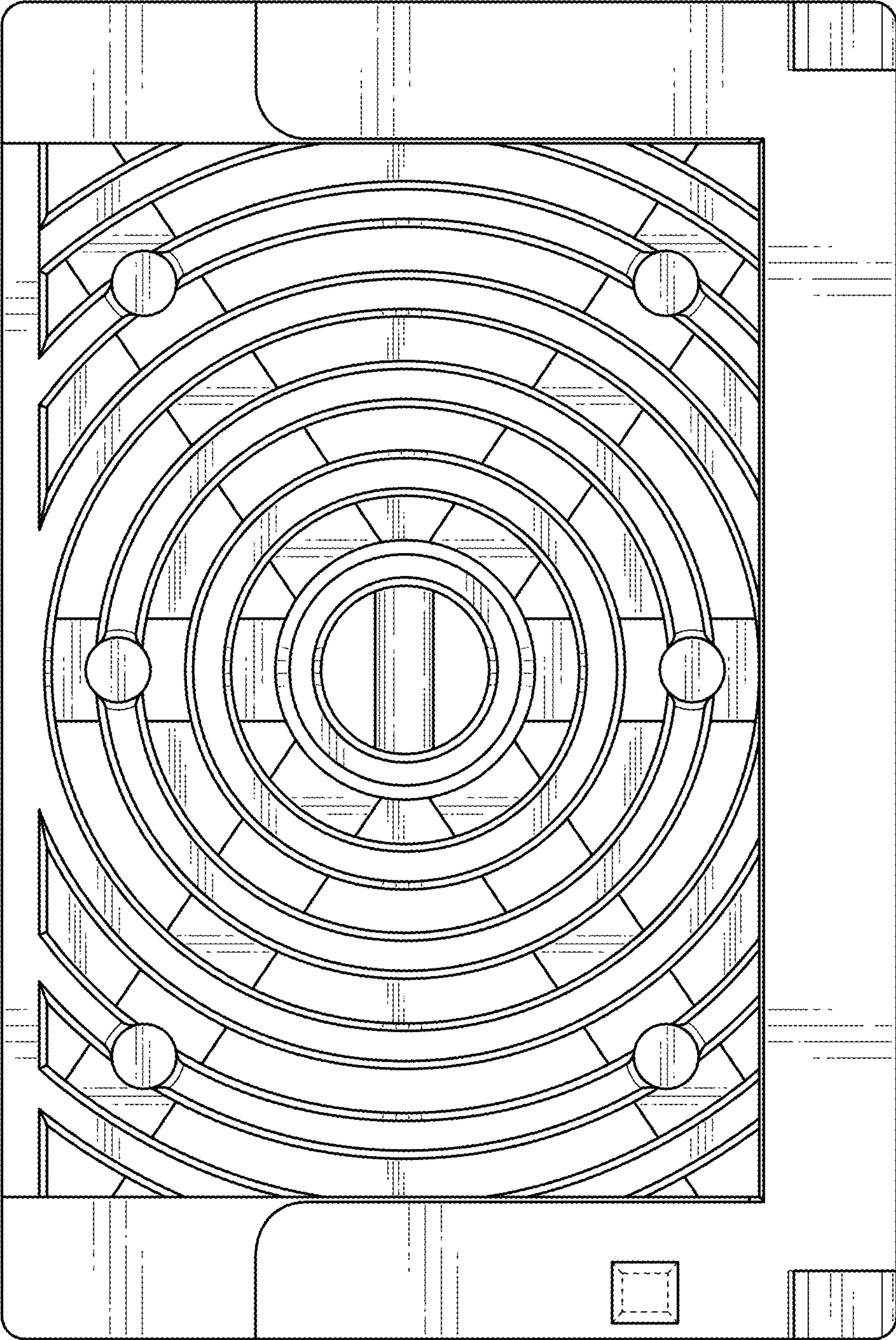

FIG. 3

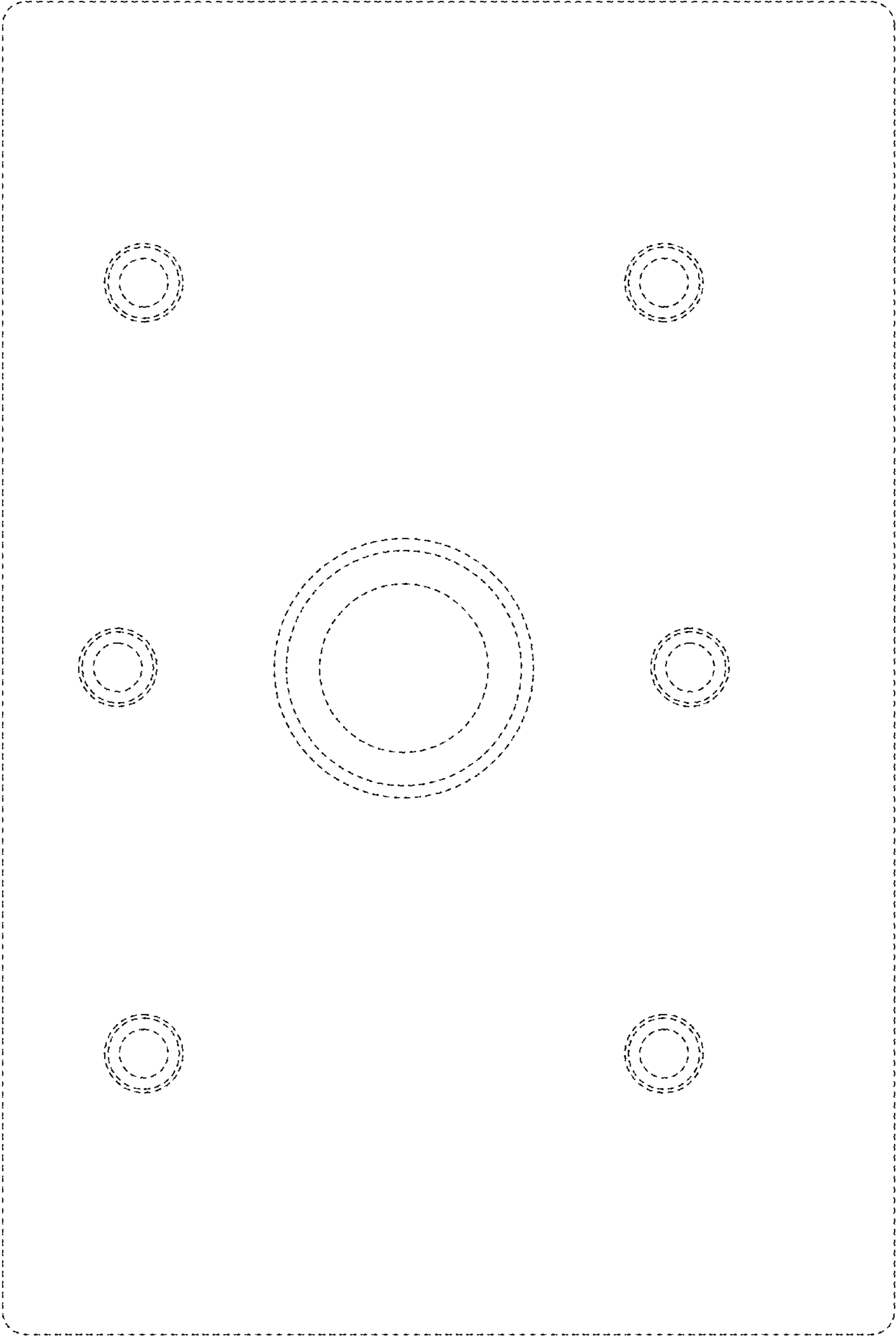

FIG. 4

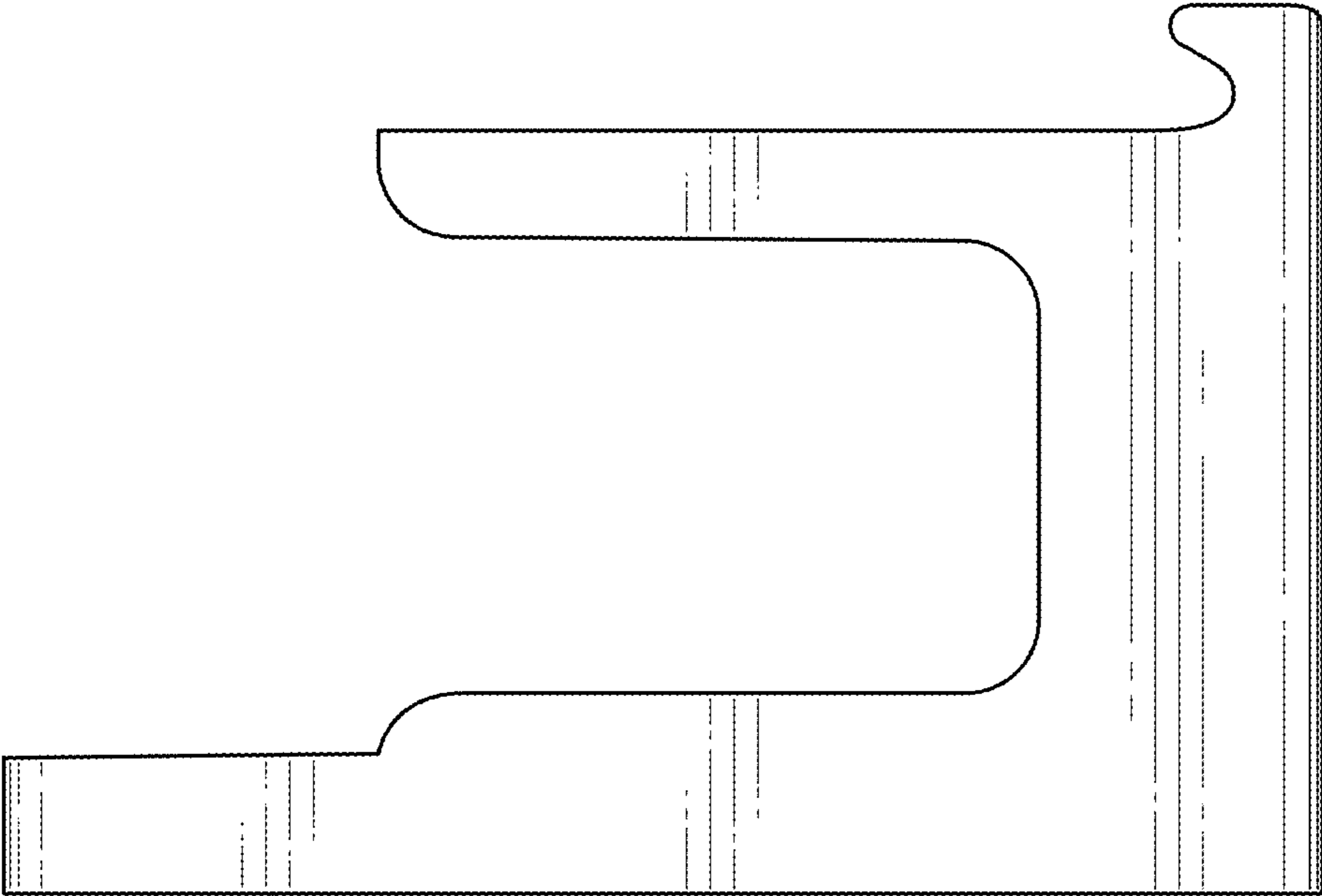

FIG. 5

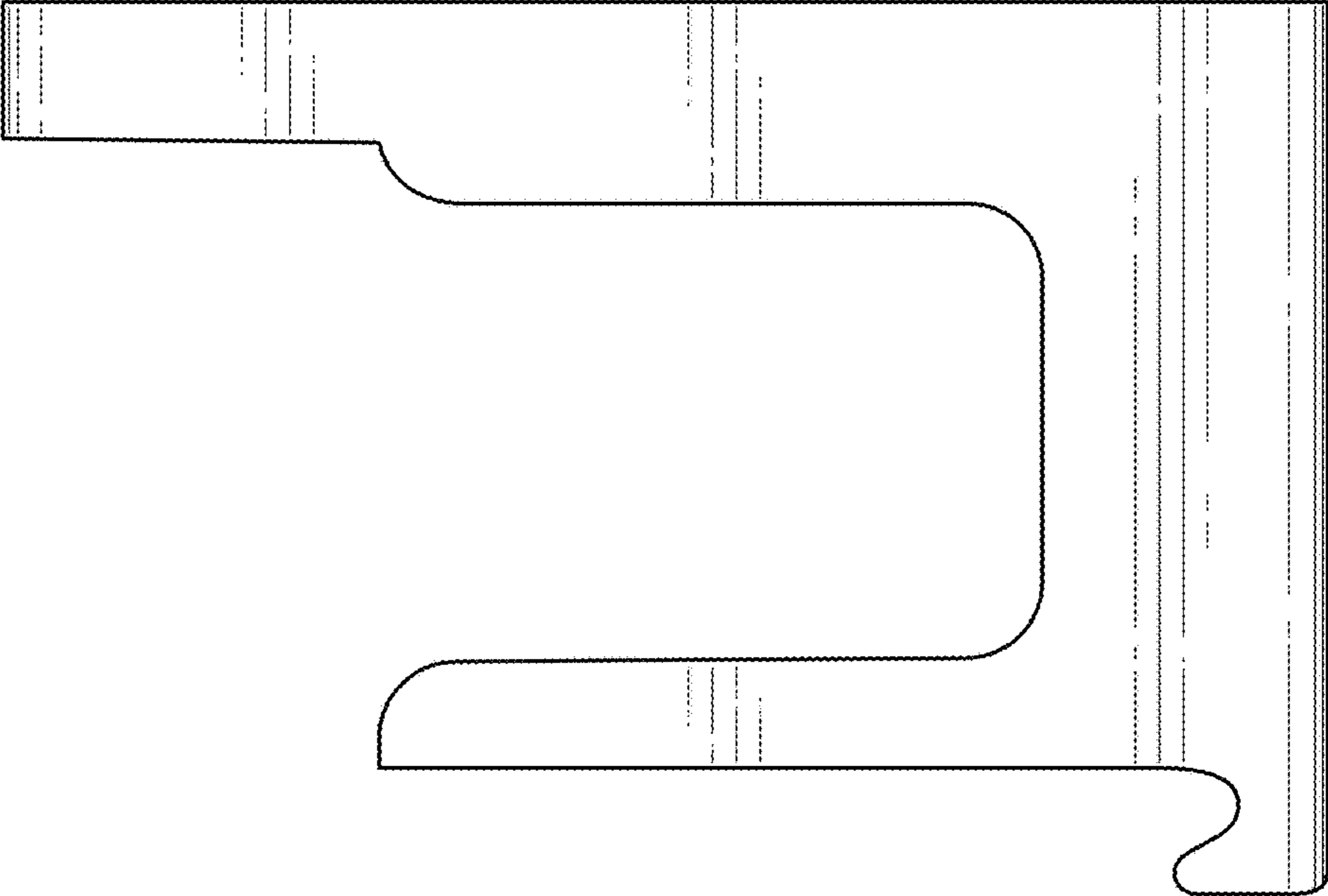

FIG. 6

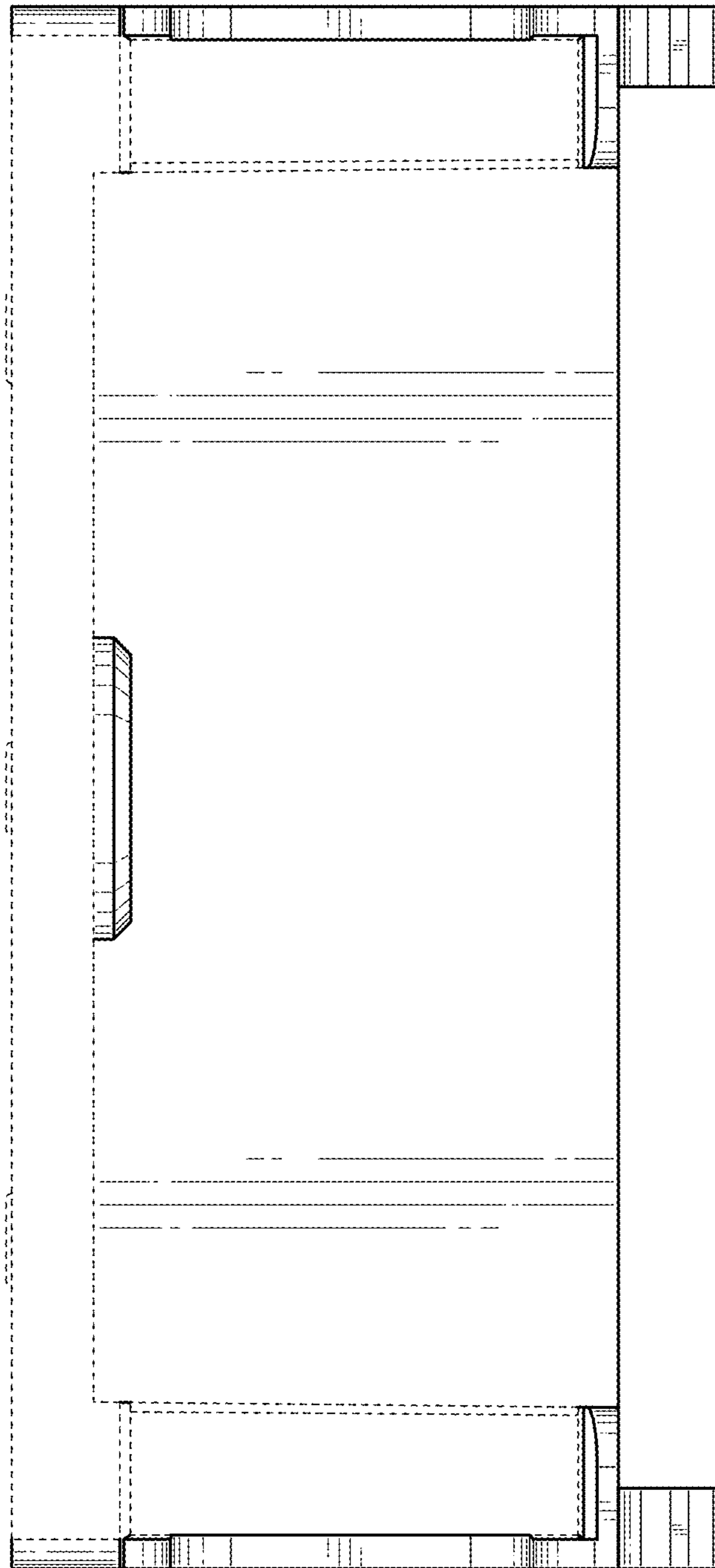

FIG. 7



FIG. 8