



US00D811894S

(12) **United States Design Patent**
Frias et al.

(10) **Patent No.:** **US D811,894 S**
(45) **Date of Patent:** **** Mar. 6, 2018**

(54) **CONTAINER WITH A PUMP DISPENSER**

(71) Applicant: **The Procter & Gamble Company,**
Cincinnati, OH (US)

(72) Inventors: **Lucio Frias,** Madeira, OH (US);
Christopher Joseph Burgbacher,
Cincinnati, OH (US); **Peter Karl**
Patzak, Muehlthal (DE)

(73) Assignee: **The Procter & Gamble Company,**
Cincinnati, OH (US)

(**) Term: **15 Years**

(21) Appl. No.: **29/593,658**

(22) Filed: **Feb. 10, 2017**

(51) **LOC (11) Cl.** **09-01**

(52) **U.S. Cl.**
USPC **D9/682**

(58) **Field of Classification Search**
USPC D9/682-694, 719, 772-780, 500-505,
D9/516, 517, 520, 531-536, 544-546,
D9/549-558, 574, 575, 434-436, 443,
D9/448; D6/542

CPC B65D 83/0094; B65D 83/14; B65D 83/16;
B65D 83/20; B65D 83/207; B65D 83/38;
B65D 83/40; B65D 1/00; B65D 1/02;
B65D 1/0223; B65D 1/023; B65D
1/0246; B65D 1/0253; B65D 1/0261;
B65D 1/32; B65D 1/323; B65D 1/40;
B65D 2501/0009; B65D 2501/0081;
B05B 11/00-11/3098; A47K 5/12; A47K
5/1201; A47K 5/122; A47K 5/14

See application file for complete search history.

(56) **References Cited**

U.S. PATENT DOCUMENTS

D338,828 S * 8/1993 Segati D9/447
5,287,996 A * 2/1994 Uhlig A47K 5/12
222/173

D348,388 S * 7/1994 Kuzma D9/575
D351,991 S * 11/1994 Bertolini D9/558
D372,859 S * 8/1996 Lathrop D9/558
D381,915 S * 8/1997 Dinand D9/545
D392,887 S * 3/1998 Wadsworth D9/448
D393,804 S * 4/1998 Gavin D9/449
D425,432 S * 5/2000 Lewin D9/558
D449,230 S * 10/2001 Harris D9/558
D459,996 S * 7/2002 Kuzma D9/549
D466,017 S * 11/2002 Kuo D9/448
D467,815 S * 12/2002 Cummings D9/558
D471,820 S * 3/2003 Faillant-Dumas D9/529
D499,966 S * 12/2004 Arminak D9/448
D560,942 S * 2/2008 Hanna D6/542
D574,707 S * 8/2008 Pietrowski D9/448
D607,742 S * 1/2010 Kuzma D9/558
D641,625 S * 7/2011 Kaplan D9/447
D718,147 S * 11/2014 Still D9/691
D748,491 S * 2/2016 Jin D9/682

(Continued)

Primary Examiner — Catherine Tuttle

(74) *Attorney, Agent, or Firm* — Linda M. Sivik

(57) **CLAIM**

The ornamental design for a container with a pump dispenser, as shown and described.

DESCRIPTION

FIG. 1 is a perspective view of a container with a pump dispenser, embodying our new design; FIG. 2 is a first side view thereof; FIG. 3 is a second side view thereof; FIG. 4 is a third side view thereof; FIG. 5 is a fourth side view thereof; FIG. 6 is a top view thereof; and, FIG. 7 is a bottom view thereof.

The dashed lines shown in FIG. 7 represent the central region of the bottom end that forms no part of the claimed design.

1 Claim, 4 Drawing Sheets

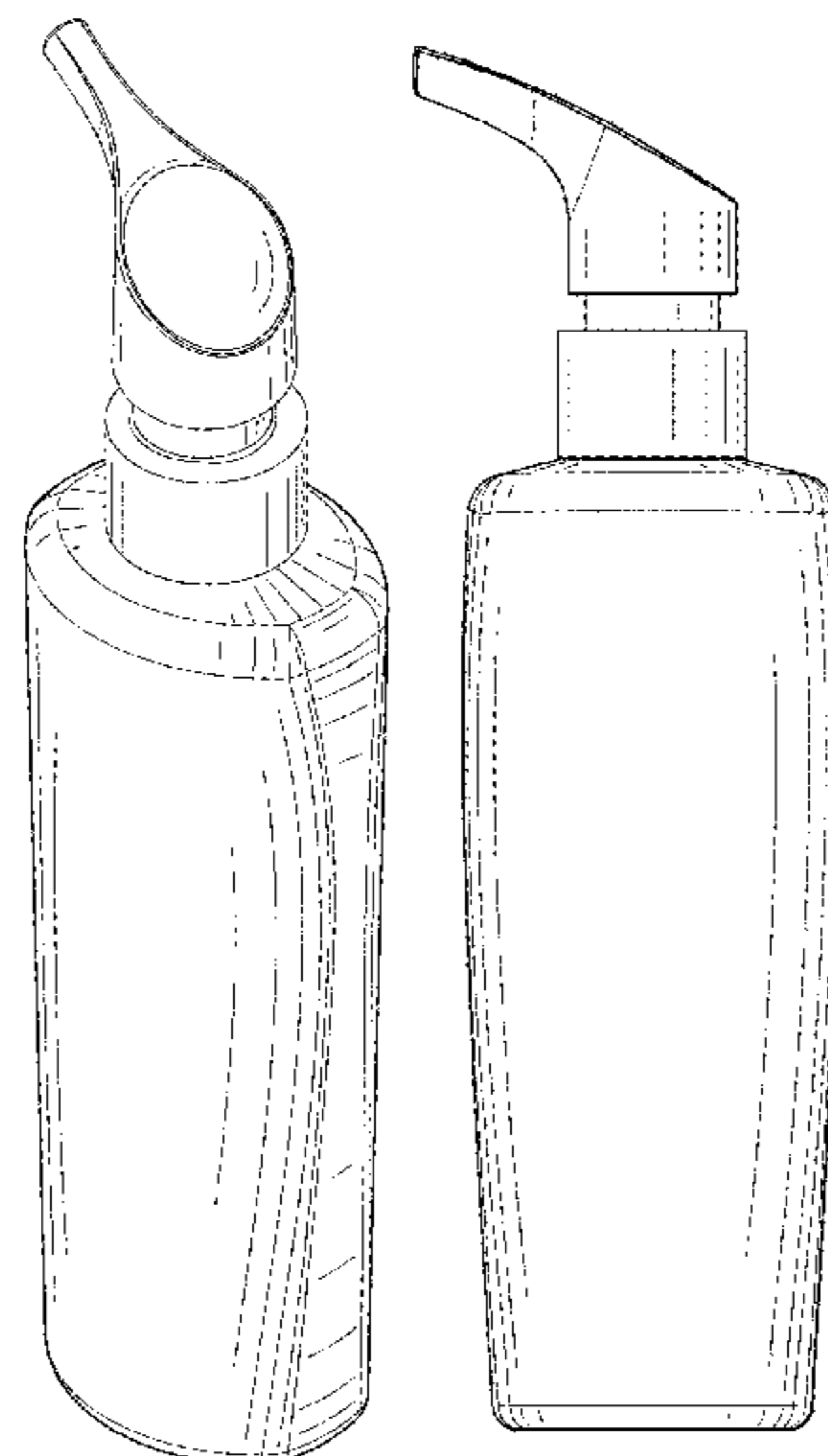

(56)

References Cited

U.S. PATENT DOCUMENTS

2012/0111890 A1* 5/2012 Herring A47K 5/12
222/180
2013/0284195 A1* 10/2013 Murdock A45D 34/00
132/200

* cited by examiner

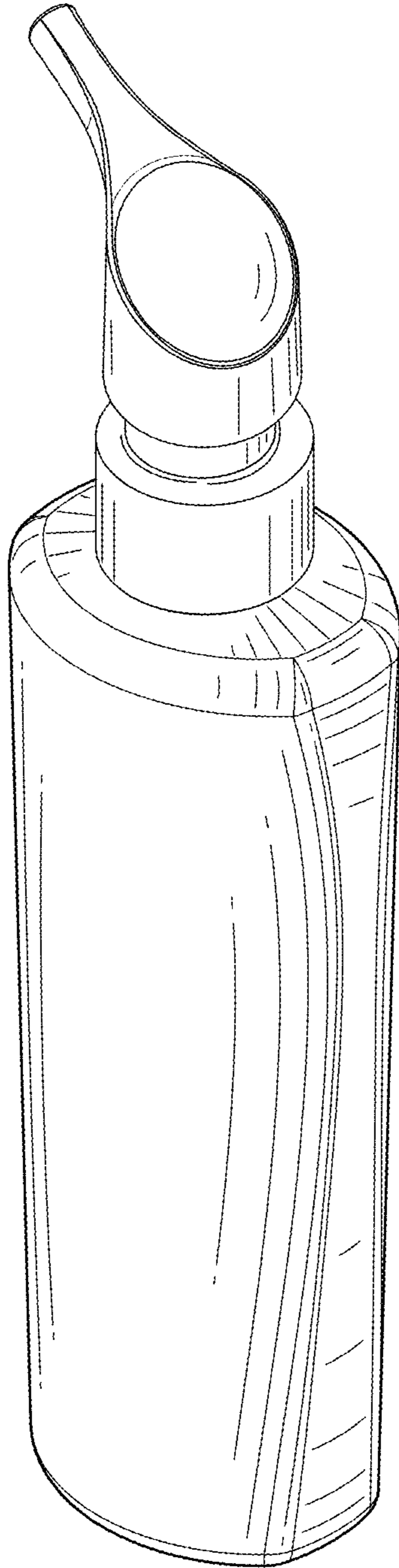

Fig. 1

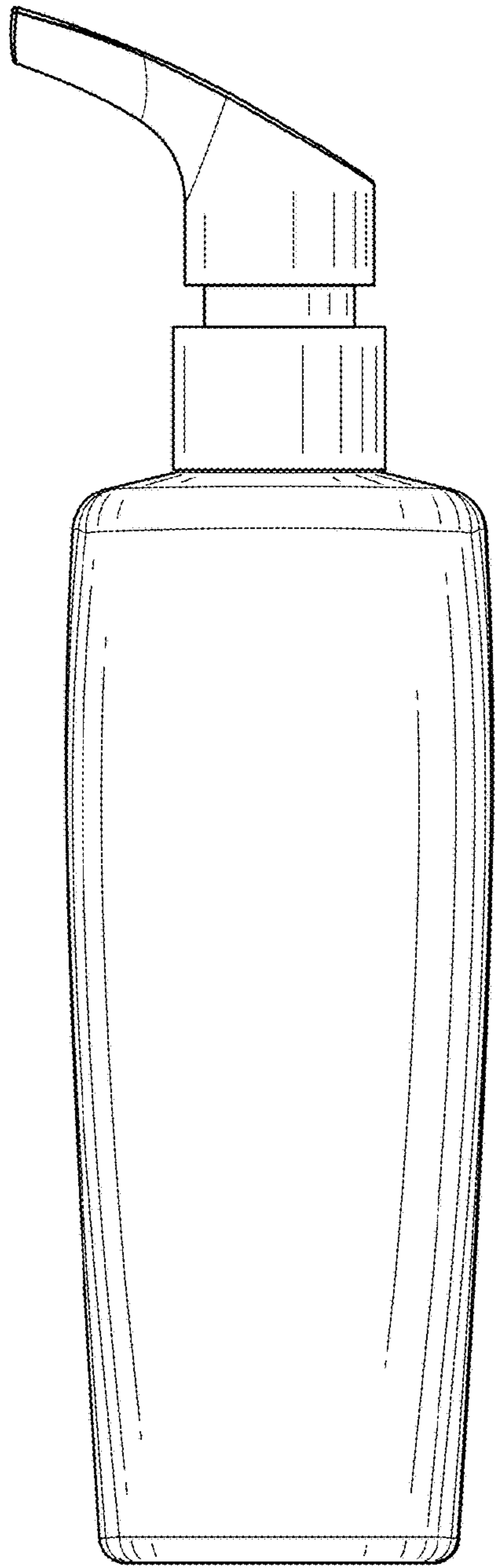

Fig. 2

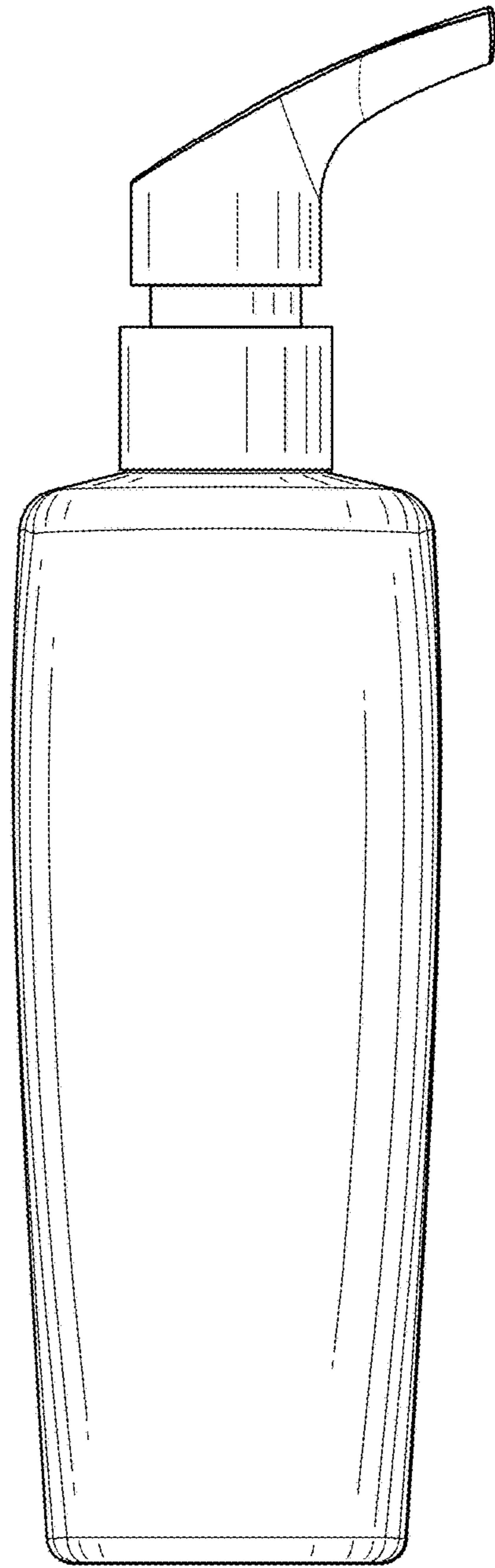

Fig. 3

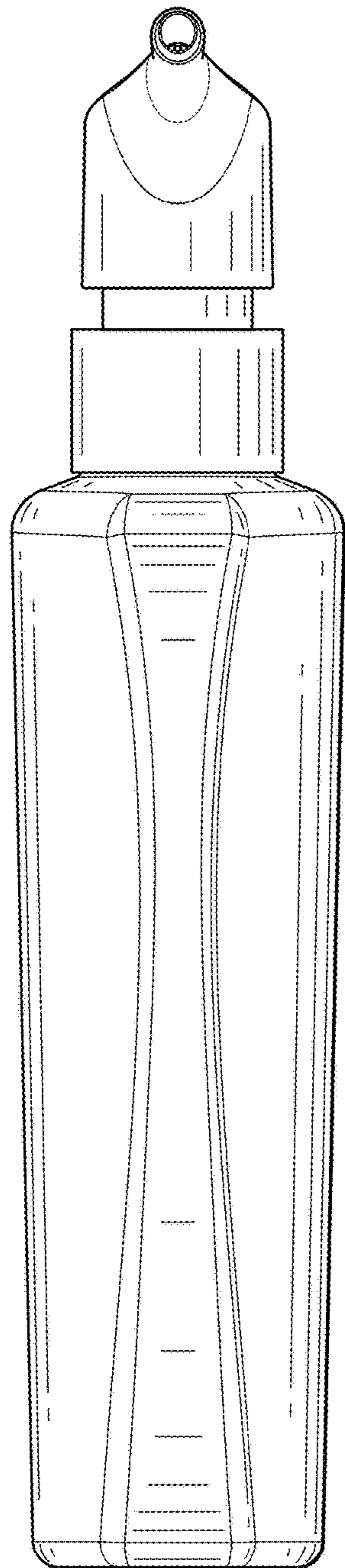

Fig. 4

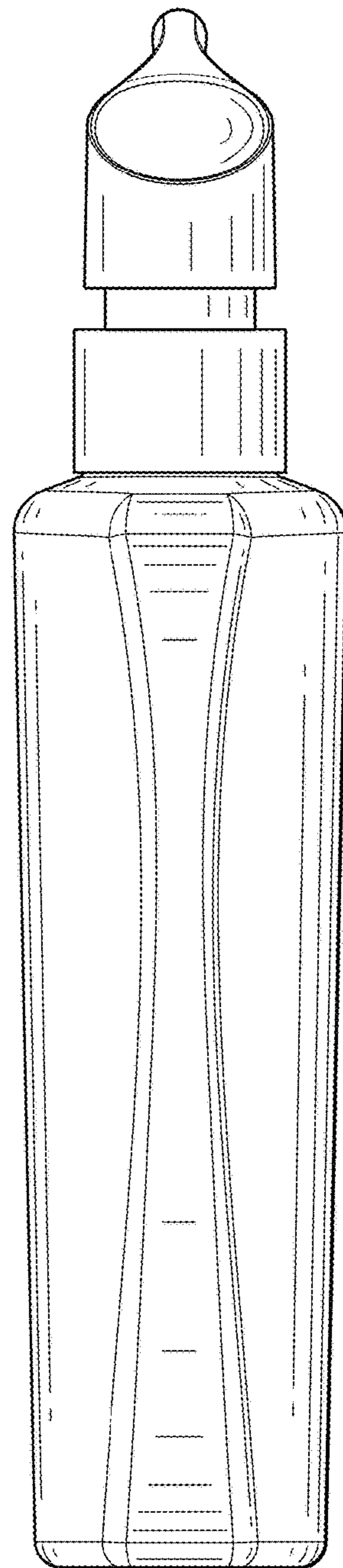

Fig. 5

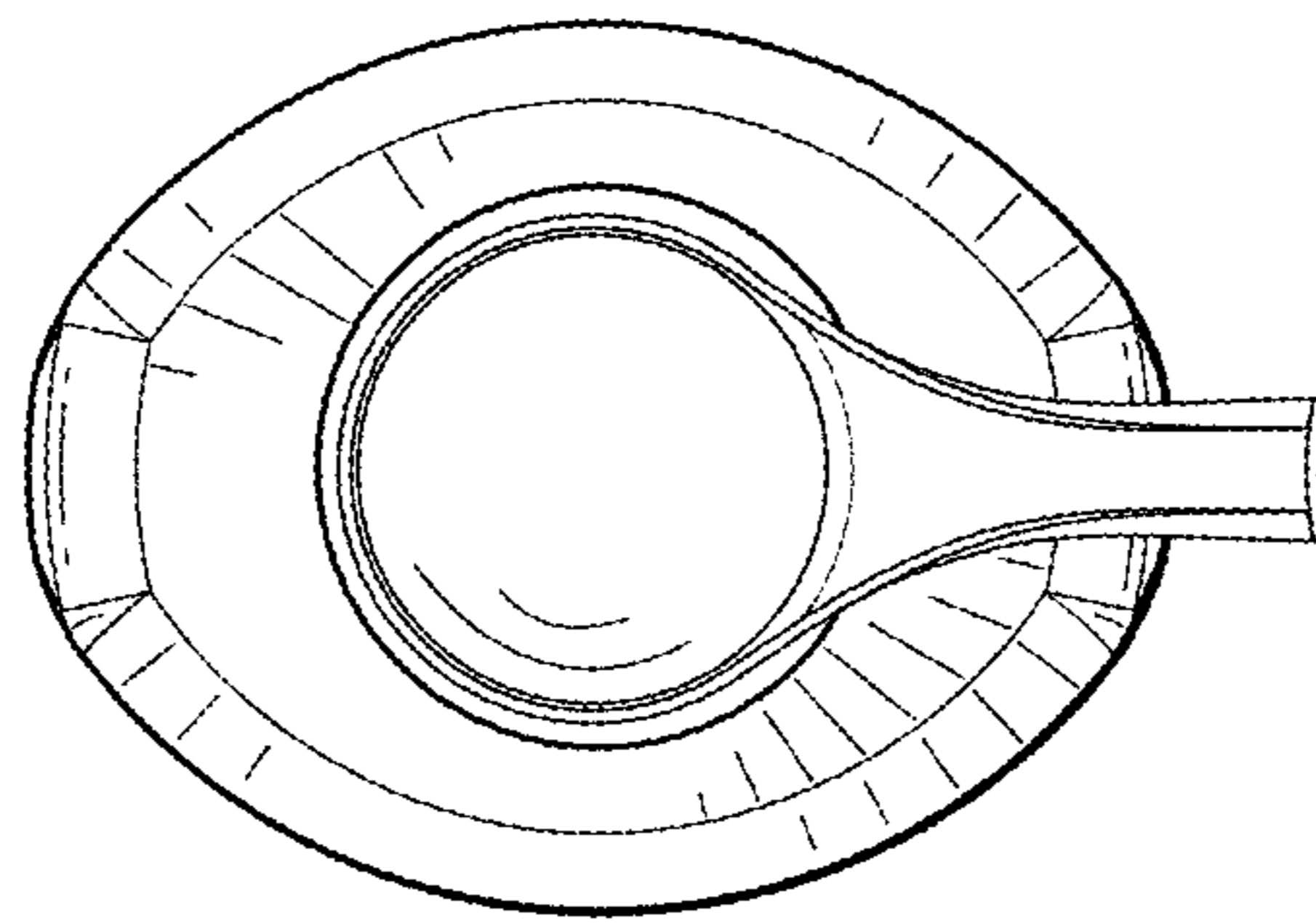

Fig. 6

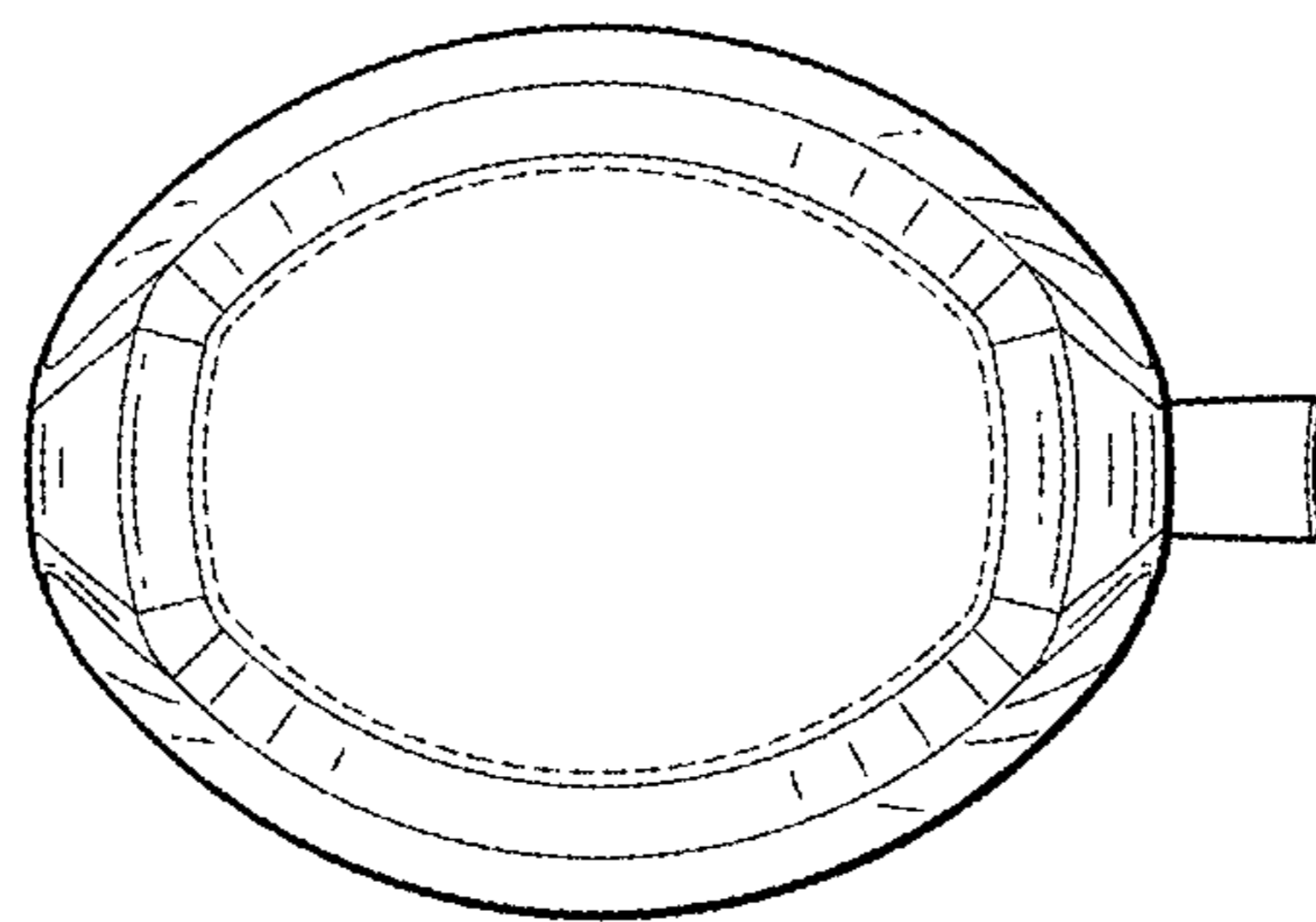

Fig. 7