



US00D811734S

(12) **United States Design Patent**
Jakubowski

(10) **Patent No.:** **US D811,734 S**
(45) **Date of Patent:** **** Mar. 6, 2018**

(54) **TOTE BAG**

D463,118 S 9/2002 Tucker
D562,551 S 2/2008 Liu
D773,813 S * 12/2016 Jakubowski D3/246

(71) Applicant: **Vermont Juvenile Furniture Mfg., Inc.**, West Rutland, VT (US)

* cited by examiner

(72) Inventor: **Kristen Jakubowski**, Rutland, VT (US)

Primary Examiner — Holly H Baynham

(73) Assignee: **Vermont Juvenile Furniture Mfg., Inc.**, West Rutland, VT (US)

(74) *Attorney, Agent, or Firm* — Volpe and Koenig, P.C.

(**) Term: **15 Years**

(57) **CLAIM**

The ornamental design for a tote bag, as shown and described.

(21) Appl. No.: **29/587,362**

DESCRIPTION

(22) Filed: **Dec. 13, 2016**

Related U.S. Application Data

(63) Continuation of application No. 29/532,060, filed on Jul. 1, 2015, now Pat. No. Des. 773,813.

(51) **LOC (11) Cl.** **03-01**

(52) **U.S. Cl.**
USPC **D3/232**

(58) **Field of Classification Search**
USPC D3/232–233, 240–243, 245–246
CPC A45C 1/024; A45C 3/06
See application file for complete search history.

FIG. 1 is a top, front, right perspective view of a first embodiment of a tote bag in accordance with my design; FIG. 2 is a front elevational view thereof; FIG. 3 is a rear elevational view thereof; FIG. 4 is a right side elevational view thereof; FIG. 5 is a left side elevational view thereof; FIG. 6 is a top plan view thereof; and FIG. 7 is a bottom view thereof; FIG. 8 is a top, front, right perspective view of a second embodiment of a tote bag in accordance with my design; FIG. 9 is a front elevational view thereof; FIG. 10 is a rear elevational view thereof; FIG. 11 is a right side elevational view thereof; FIG. 12 is a left side elevational view thereof; FIG. 13 is a top plan view thereof; and, FIG. 14 is a bottom view thereof.

(56) **References Cited**

U.S. PATENT DOCUMENTS

3,121,452 A * 2/1964 Hyman A45C 3/06
150/127
D392,459 S 3/1998 Jones
D403,159 S * 12/1998 Bellechili D3/232
D426,060 S 6/2000 Chapelier
D439,041 S 3/2001 Guyon

The cross hatching shown indicates a mesh and is not intended to represent any particular color. The broken lines shown indicate unclaimed portions of the tote bag.

1 Claim, 10 Drawing Sheets

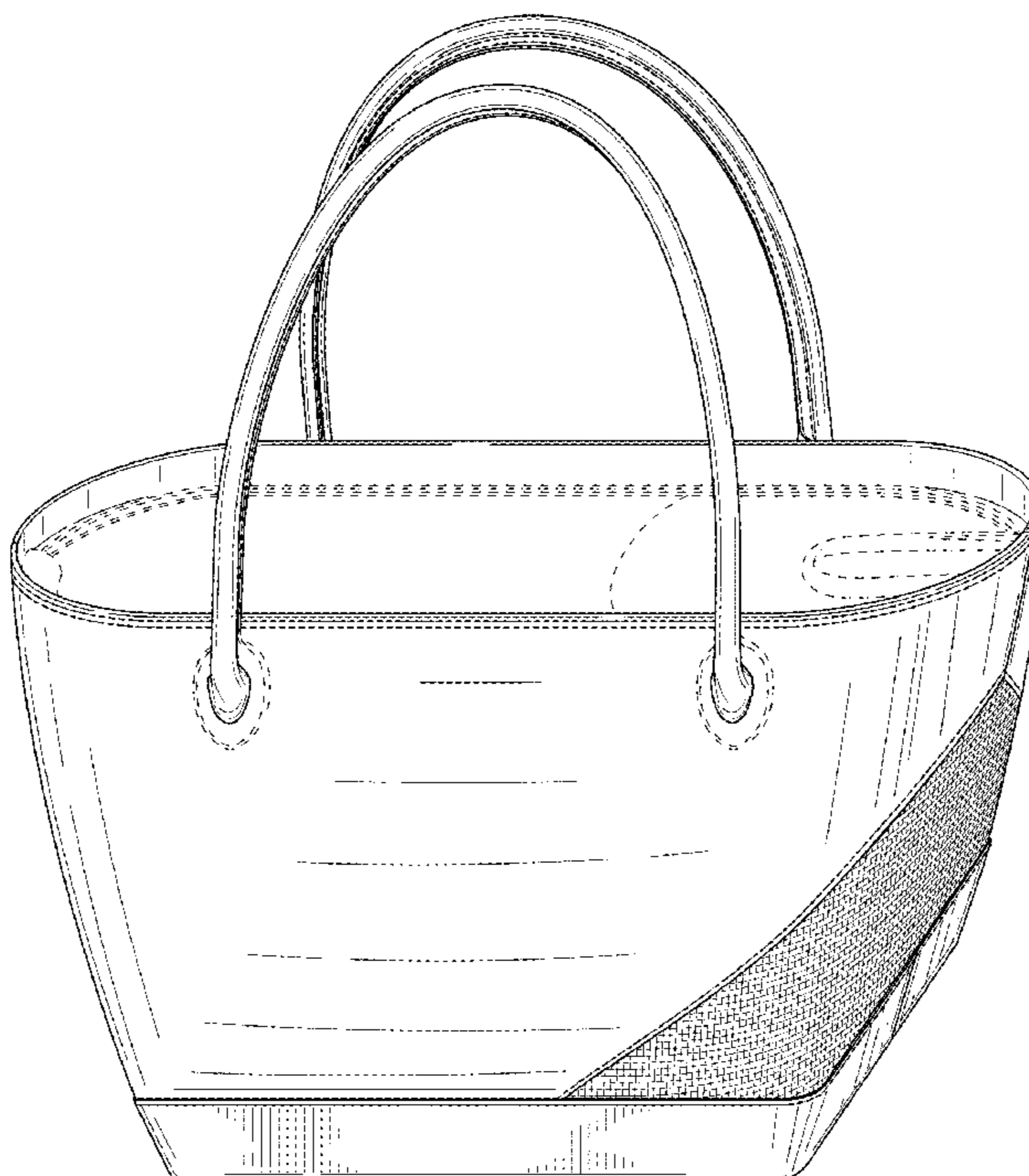

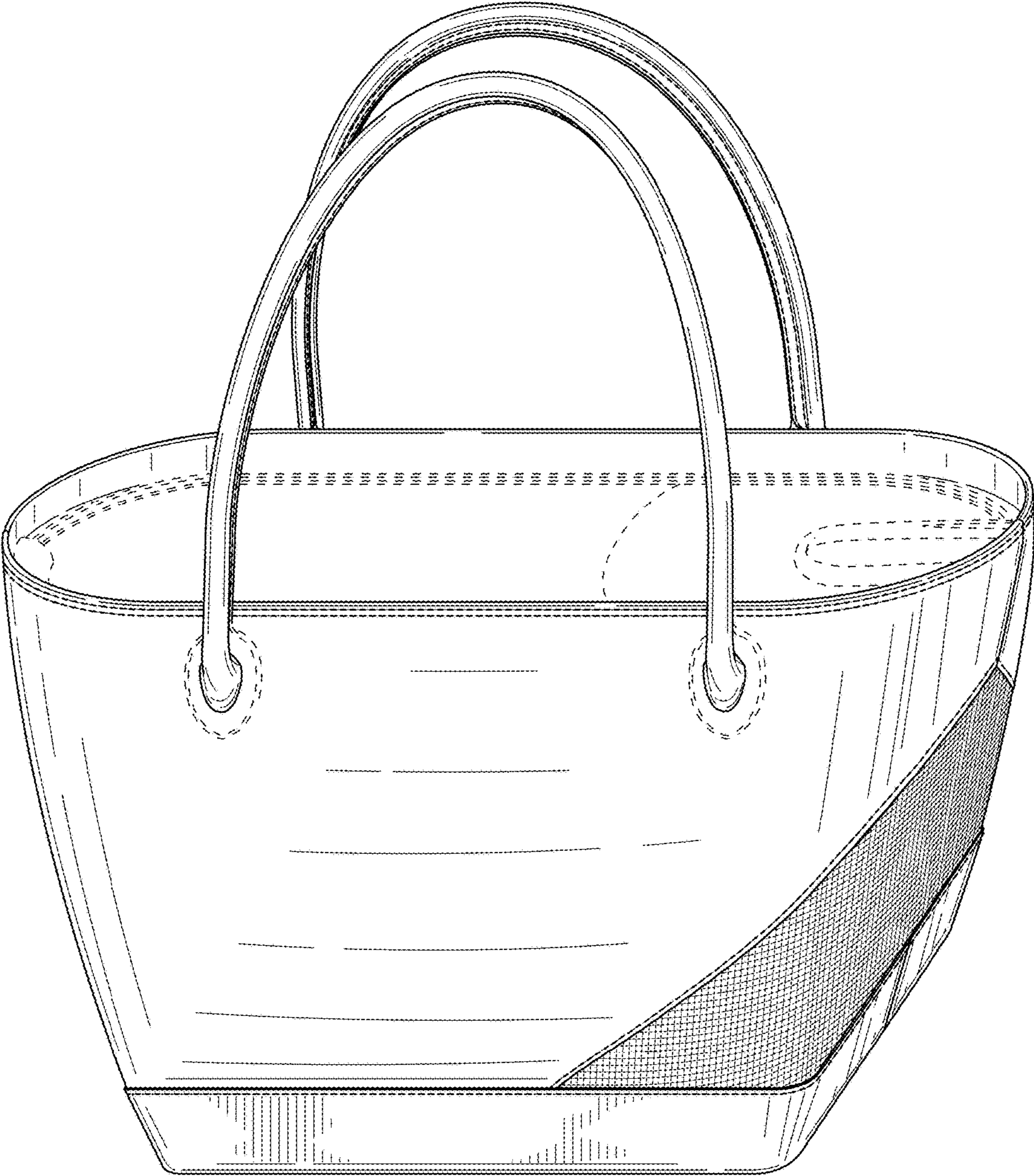

FIG. 1

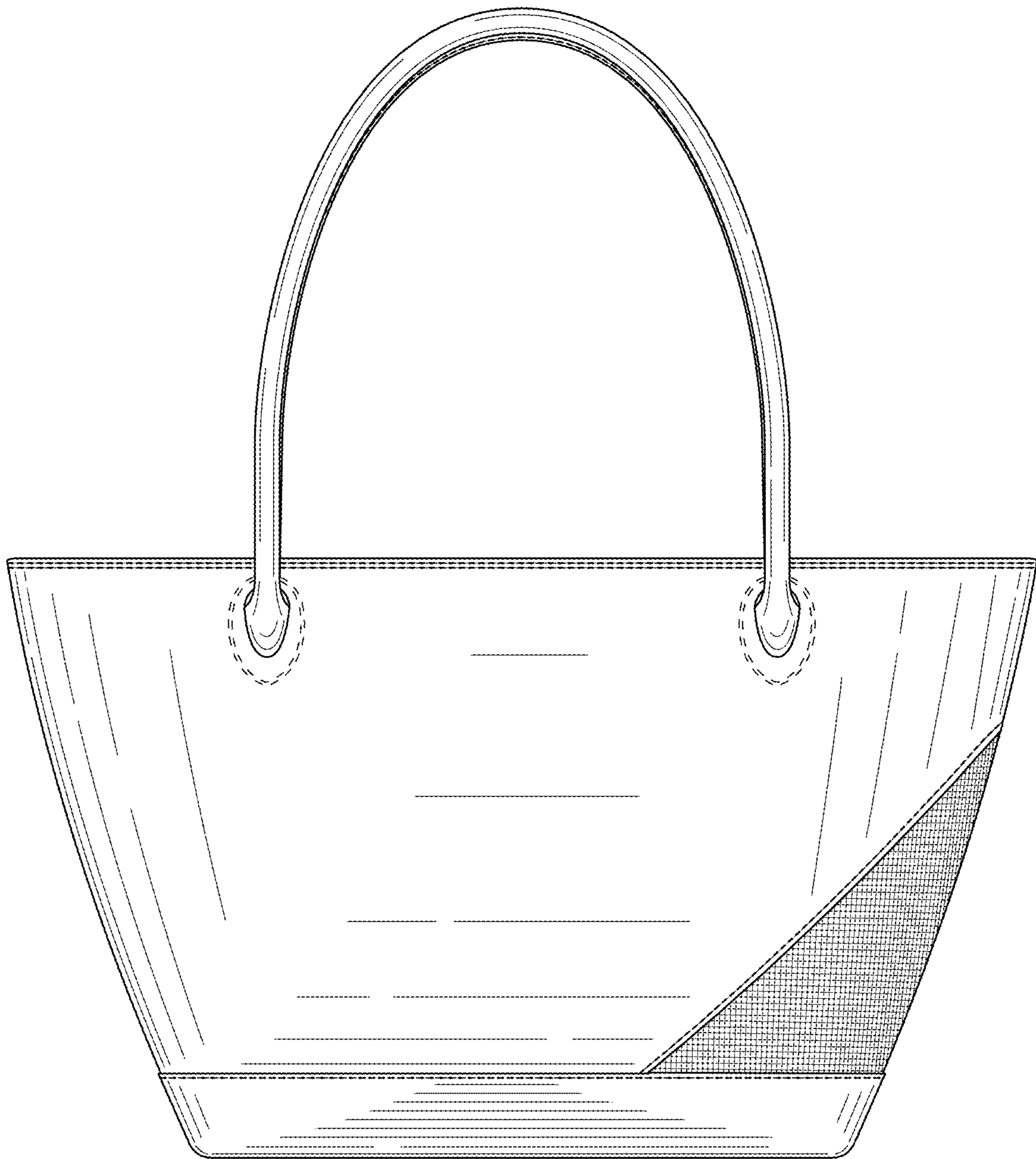

FIG. 2

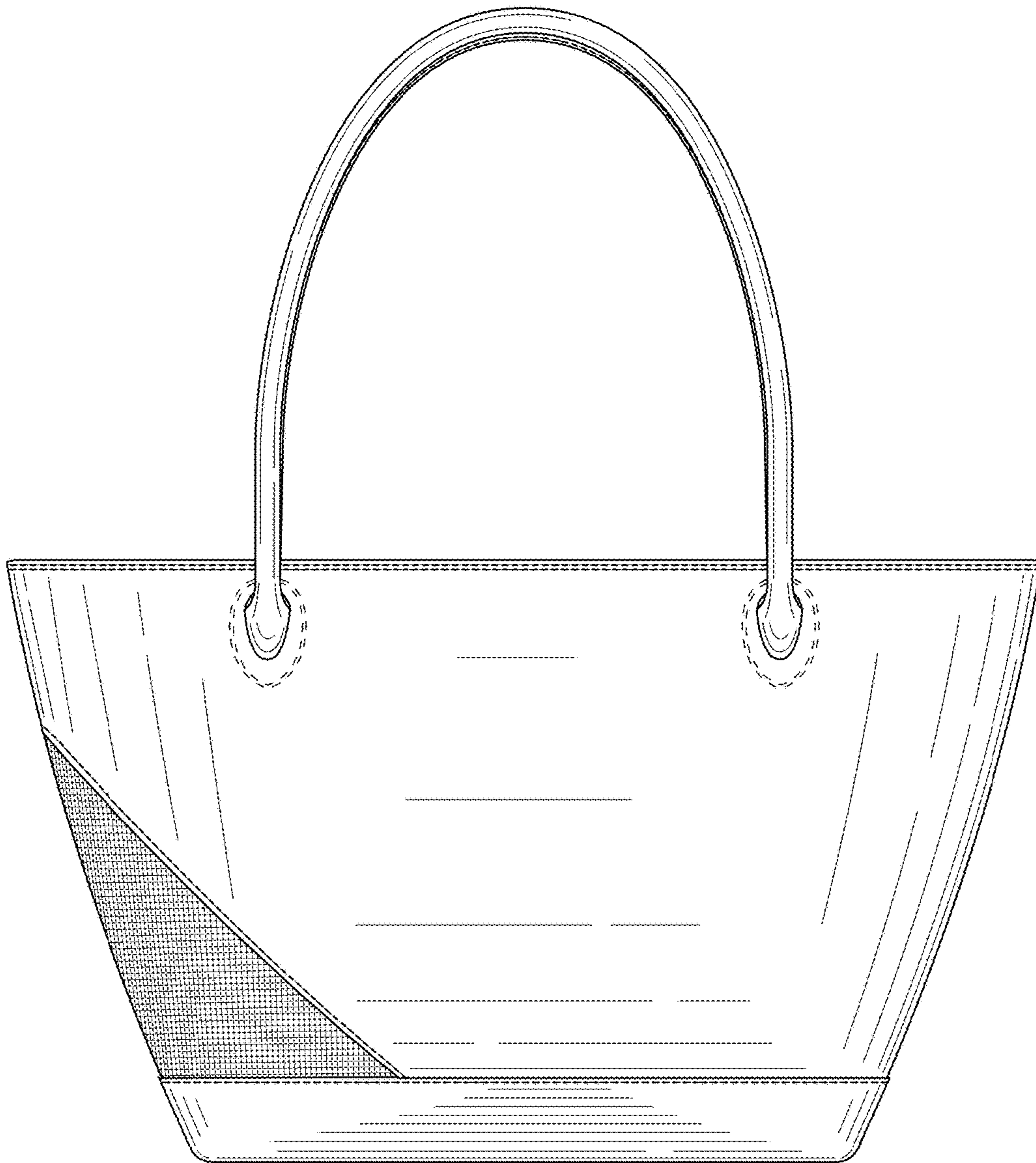

FIG. 3

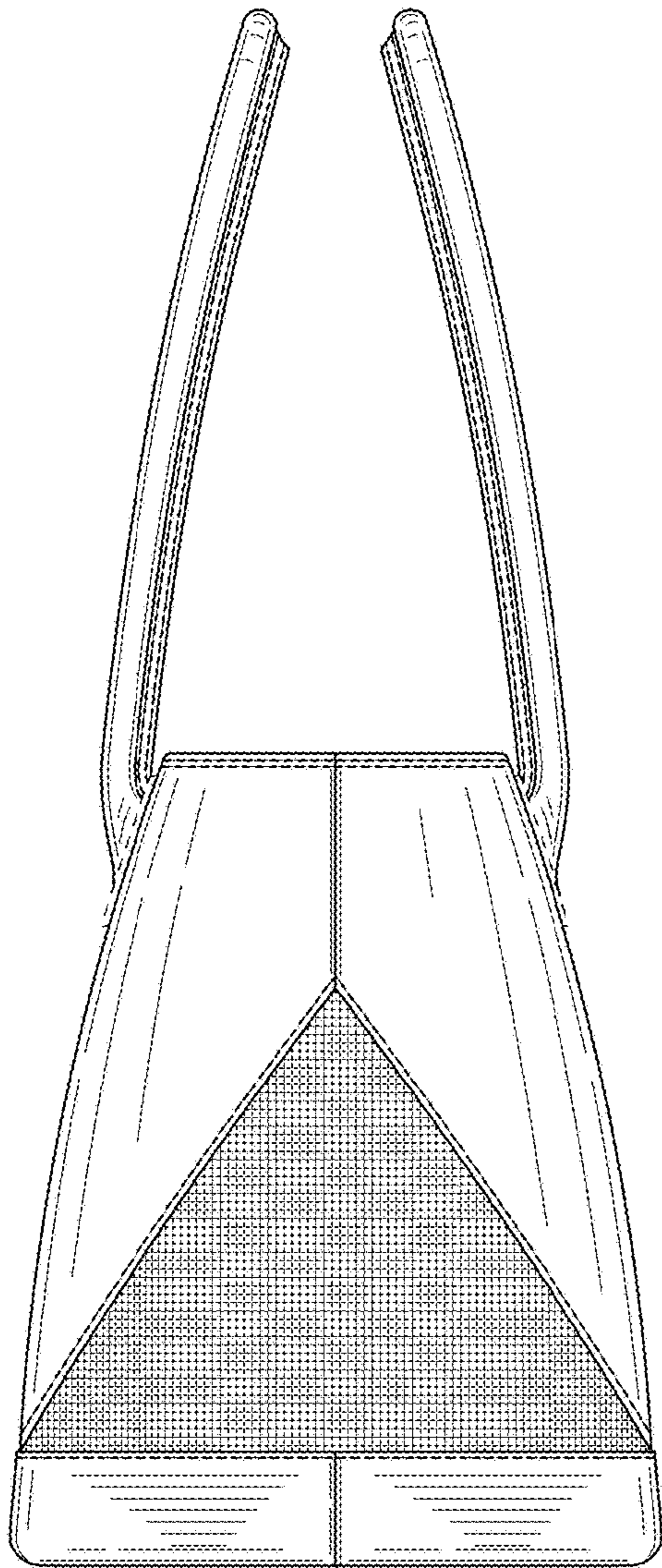

FIG. 4

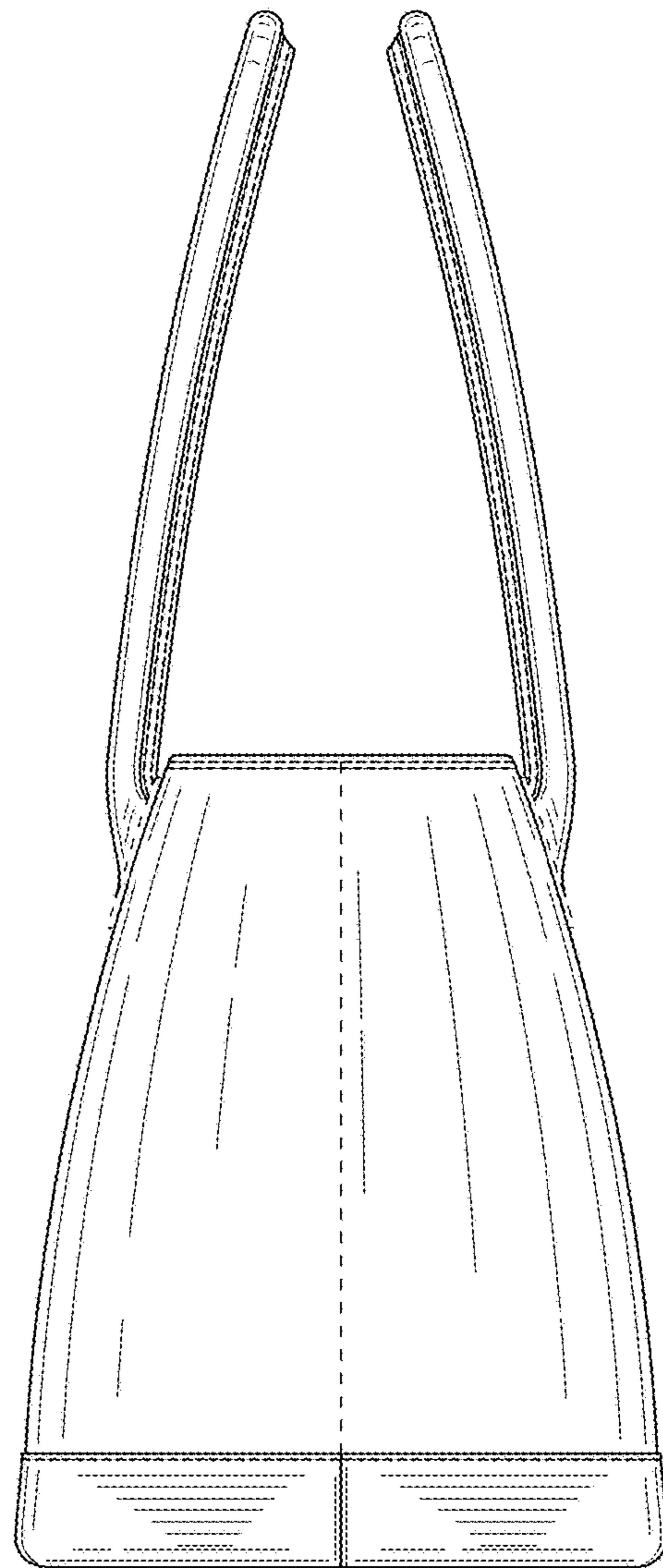

FIG. 5

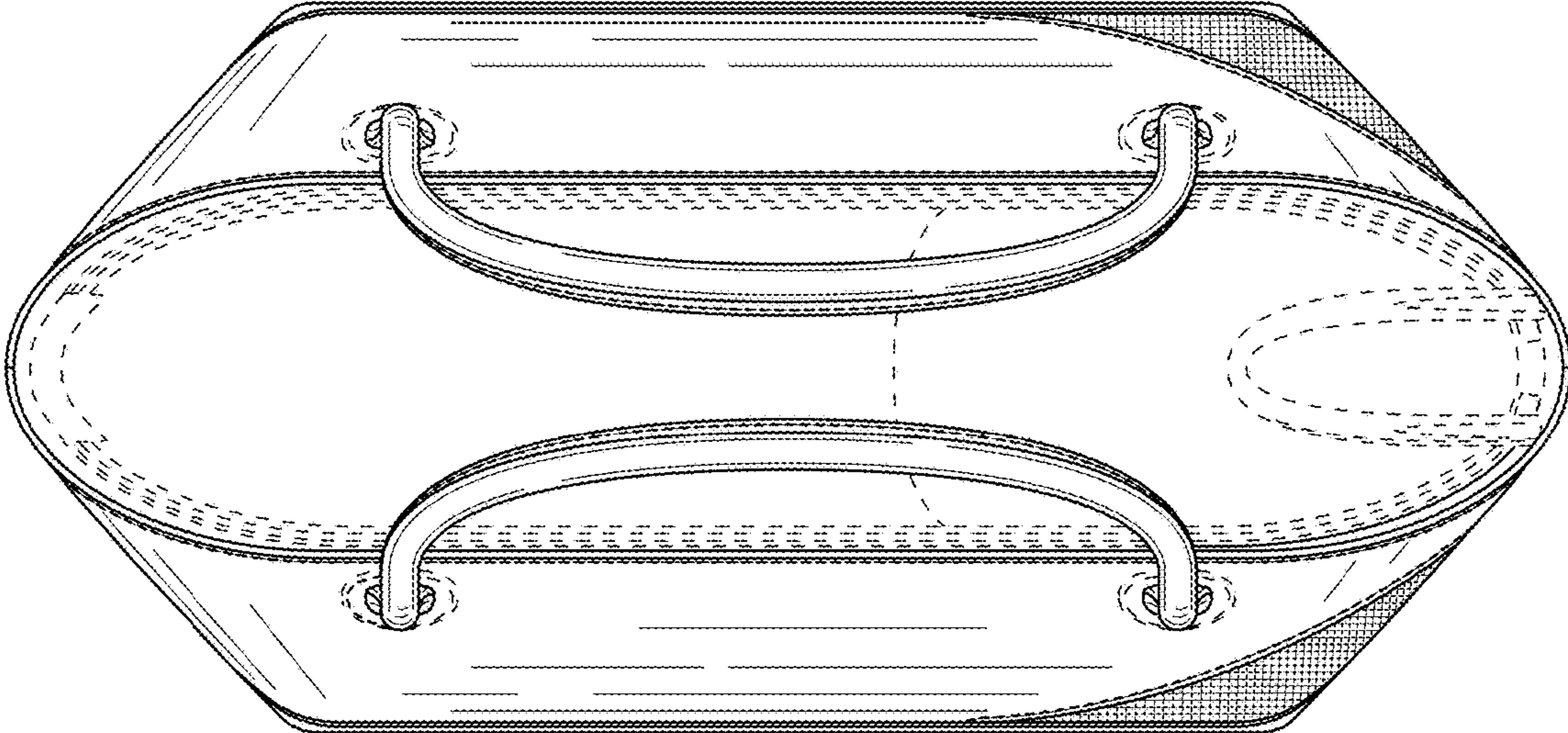

FIG. 6

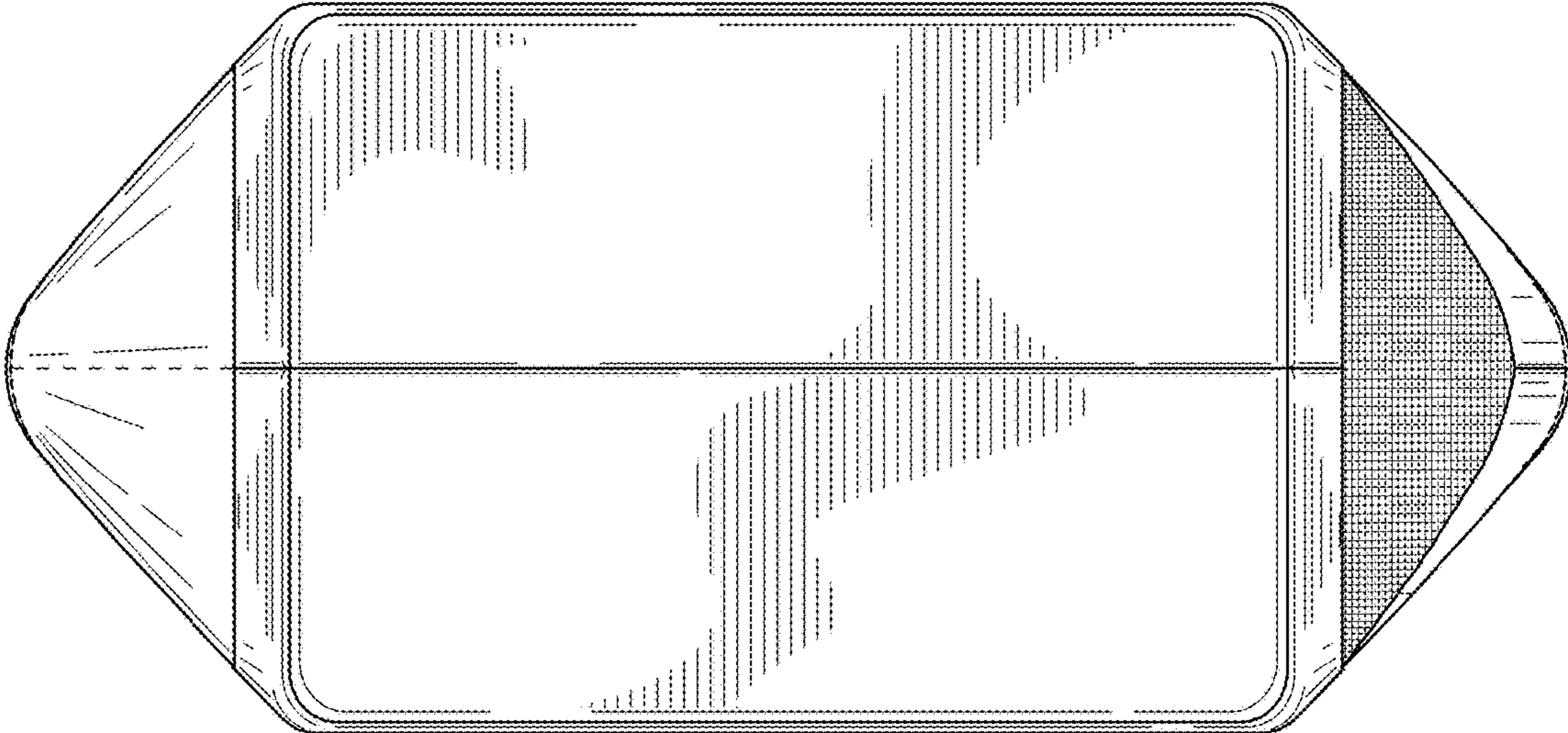

FIG. 7



FIG. 8

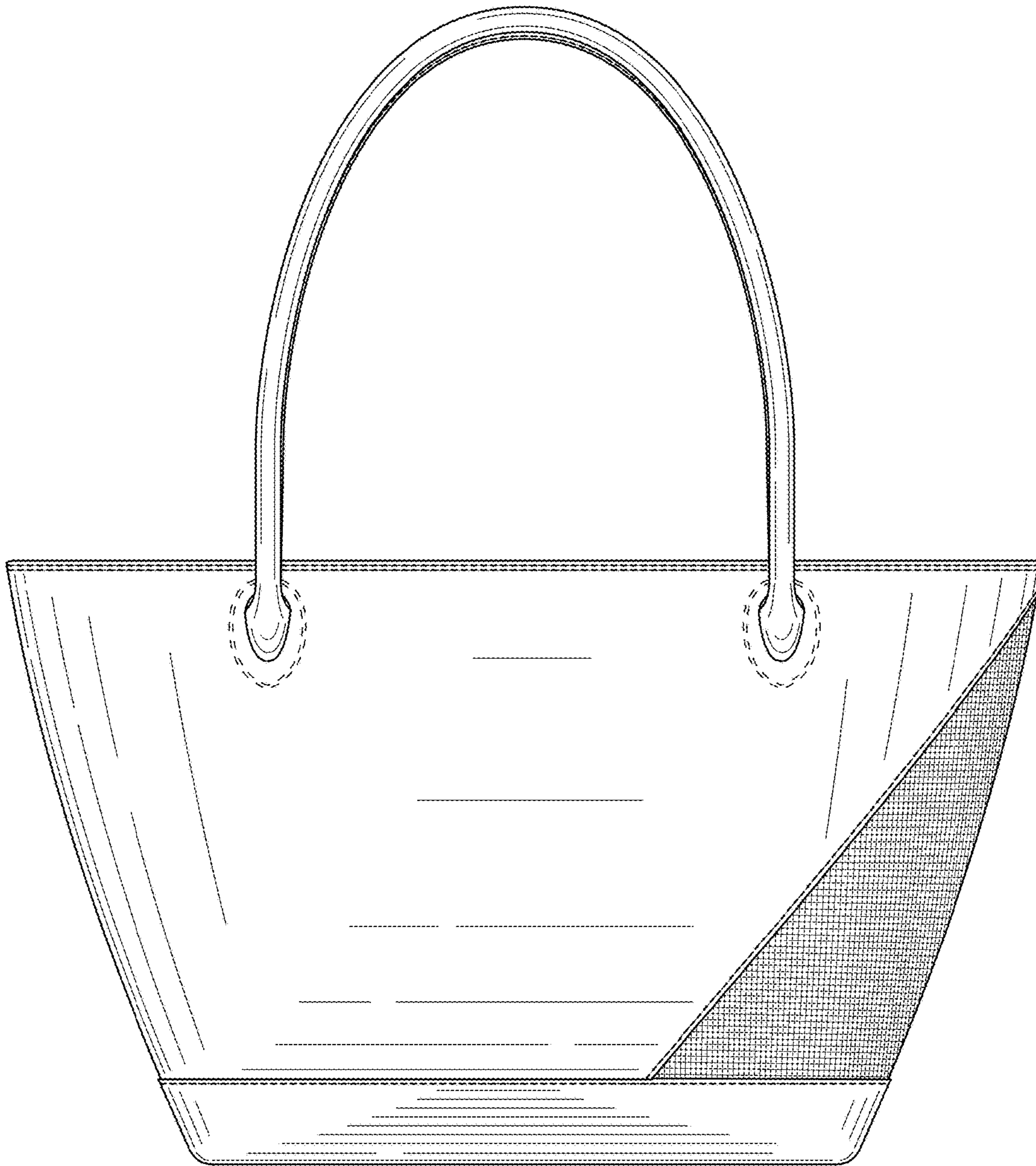

FIG. 9

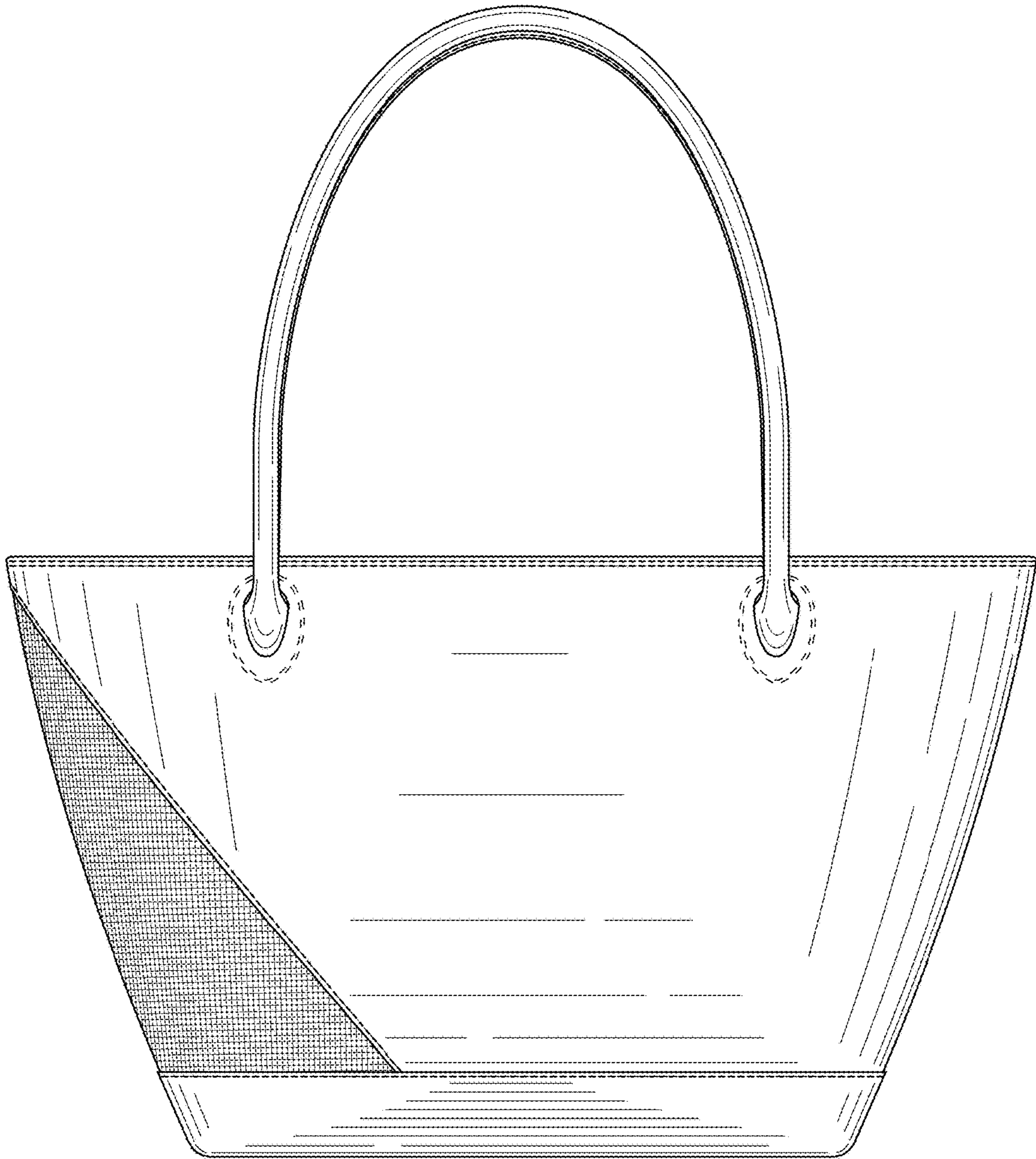

FIG. 10

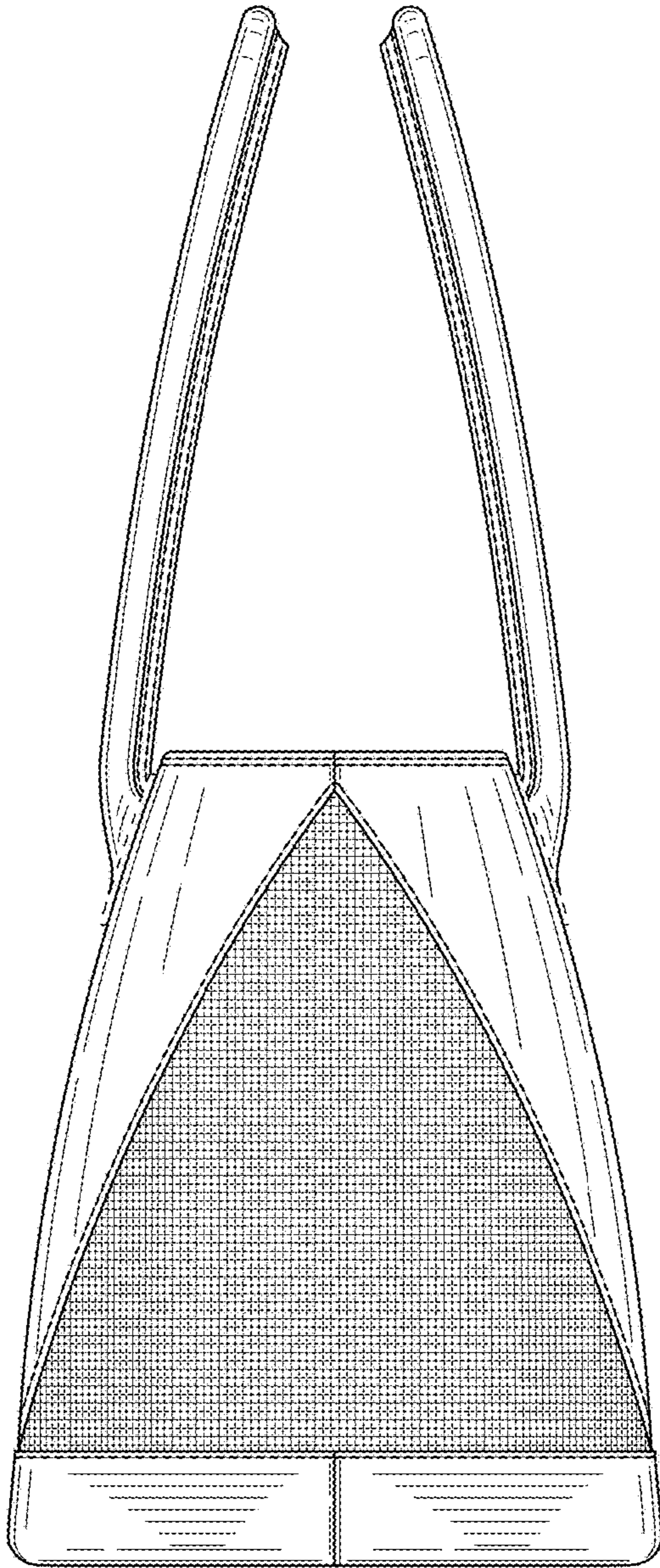

FIG. 11

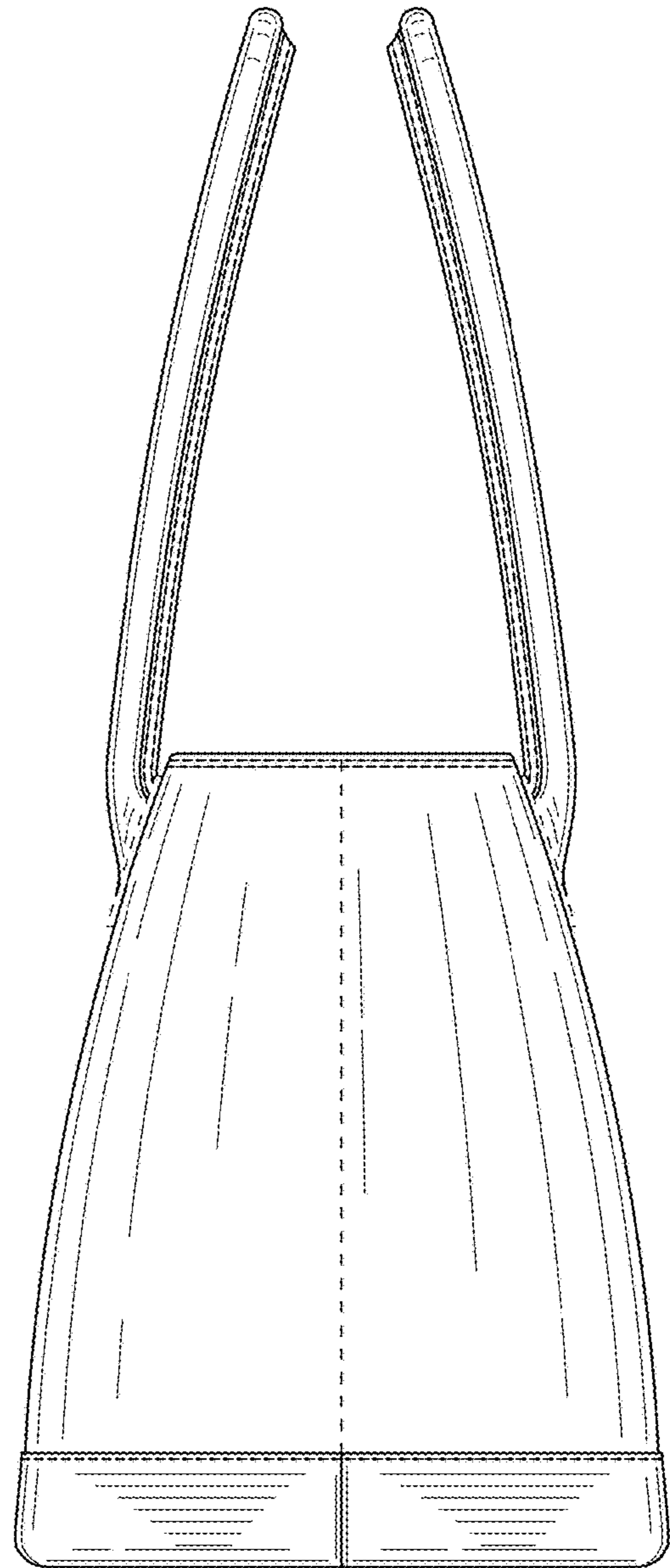

FIG. 12

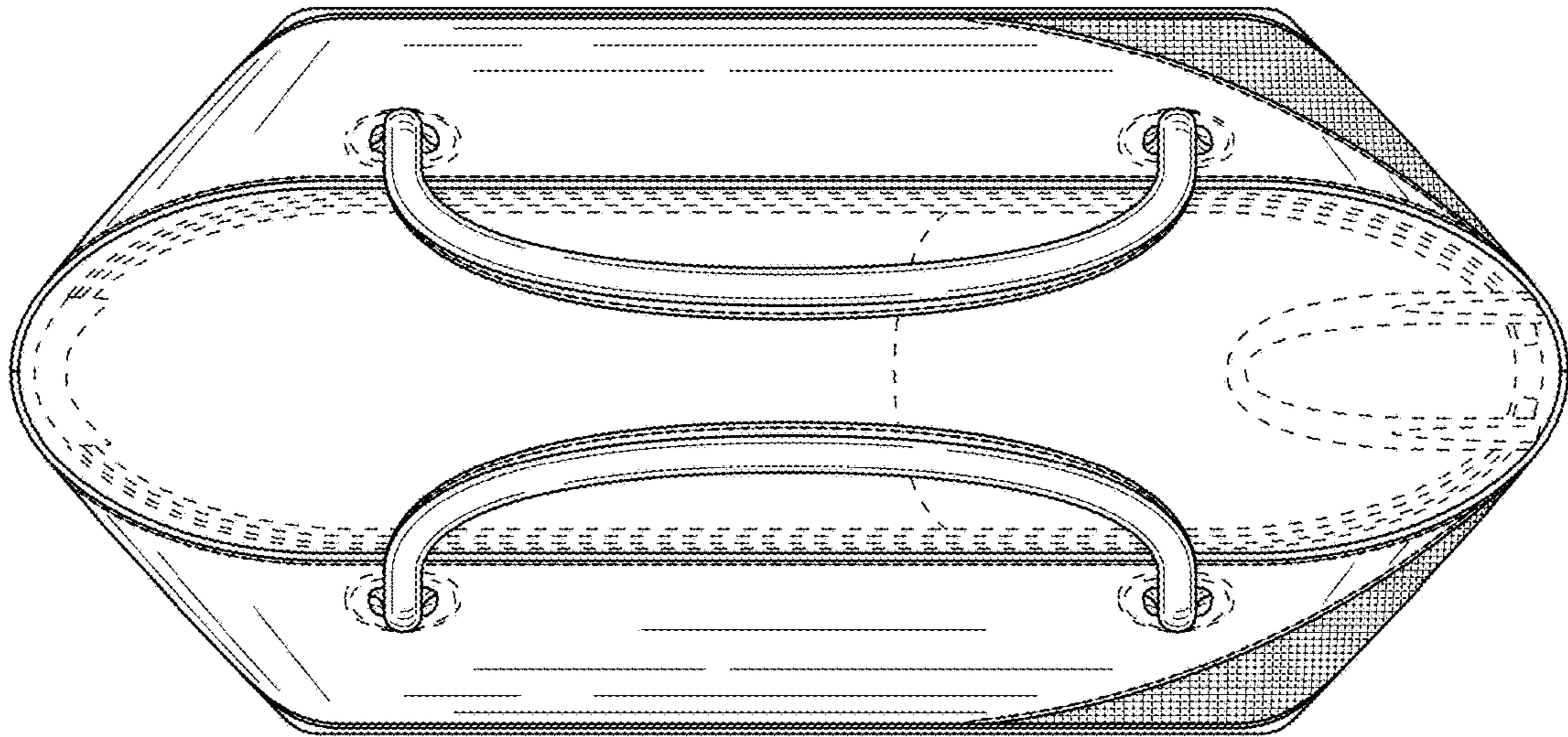

FIG. 13

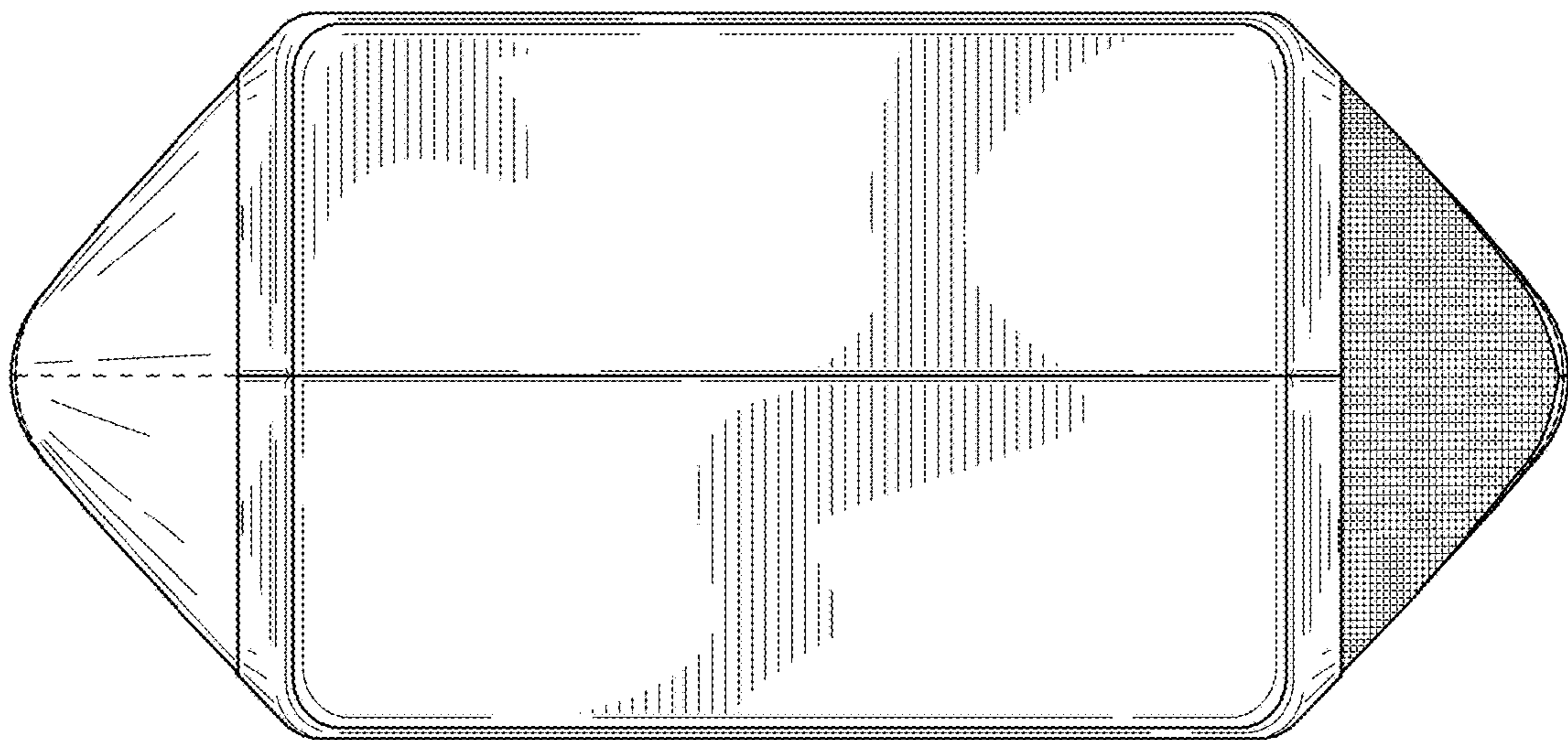

FIG. 14