



US00D811703S

(12) **United States Design Patent** (10) **Patent No.:** **US D811,703 S**
Sassi (45) **Date of Patent:** **** *Mar. 6, 2018**

(54) **SHOE** 1,977,995 A * 10/1934 Morali A43B 3/0078
12/142 R
(71) Applicant: **VALENTINO S.p.A.**, Milan (IT) D95,664 S 5/1935 Carrier
D95,690 S 5/1935 Koomruian
(72) Inventor: **Stefano Sassi**, Milan (IT) D99,016 S * 3/1936 Gleason D2/916
D100,286 S 7/1936 Rauh
D102,342 S 12/1936 Stein
D102,344 S 12/1936 Stein
D102,345 S 12/1936 Stein
D102,346 S 12/1936 Stein
(*) Notice: This patent is subject to a terminal disclaimer. D103,413 S 3/1937 Sholtz
D112,600 S * 12/1938 Delman D2/927
D129,703 S * 9/1941 Grossman D2/932
(**) Term: **15 Years** (Continued)

(21) Appl. No.: **29/560,144**

(22) Filed: **Apr. 4, 2016**

(30) **Foreign Application Priority Data**
Oct. 5, 2015 (IT) 402015000058193
(51) **LOC (11) Cl.** **02-04**
(52) **U.S. Cl.**
USPC **D2/939**
(58) **Field of Classification Search**
USPC D2/916-945, 627-640
CPC A43B 21/00; A43B 21/02; A43B 21/06;
A43B 9/14; A43B 1/0045; A43B 1/0036;
A43B 13/10; A43B 13/12; A43B 23/06;
A43B 23/07; A43B 5/12
See application file for complete search history.

(56) **References Cited**
U.S. PATENT DOCUMENTS
D37,359 S 2/1905 Borchardt
D70,267 S * 6/1926 Davis D2/931
D84,626 S * 7/1931 Craighead D2/632
D88,777 S * 12/1932 Graves D2/918
D91,531 S * 2/1934 Morali D2/930
D91,534 S * 2/1934 Morali D2/930
D91,535 S * 2/1934 Morali D2/932
D93,057 S 8/1934 Troy

OTHER PUBLICATIONS

Daily crave: Valentino Winter 2010 studded shoes, posted at heycrazy.wordpress.com, earliest date available Sep. 3, 2010, [online], acquired on Apr. 3, 2017. Available from Internet, <URL: https://heycrazy.wordpress.com/2010/09/03/daily-crave-valentino-winter-2010-studded-shoes/>.*
(Continued)

Primary Examiner — Cathron C Brooks
Assistant Examiner — Aula Soroush
(74) *Attorney, Agent, or Firm* — Thomas | Horstemeyer, LLP

(57) **CLAIM**
The ornamental design for a shoe, as shown and described.

DESCRIPTION

FIG. 1 is a perspective view of my new design;
FIG. 2 is a front view thereof;
FIG. 3 is a rear view thereof opposite that of FIG. 2;
FIG. 4 is a side view thereof;
FIG. 5 is a side view thereof, from a side opposite that of FIG. 4;
FIG. 6 is a top view thereof; and,
FIG. 7 is a bottom view thereof.

1 Claim, 7 Drawing Sheets

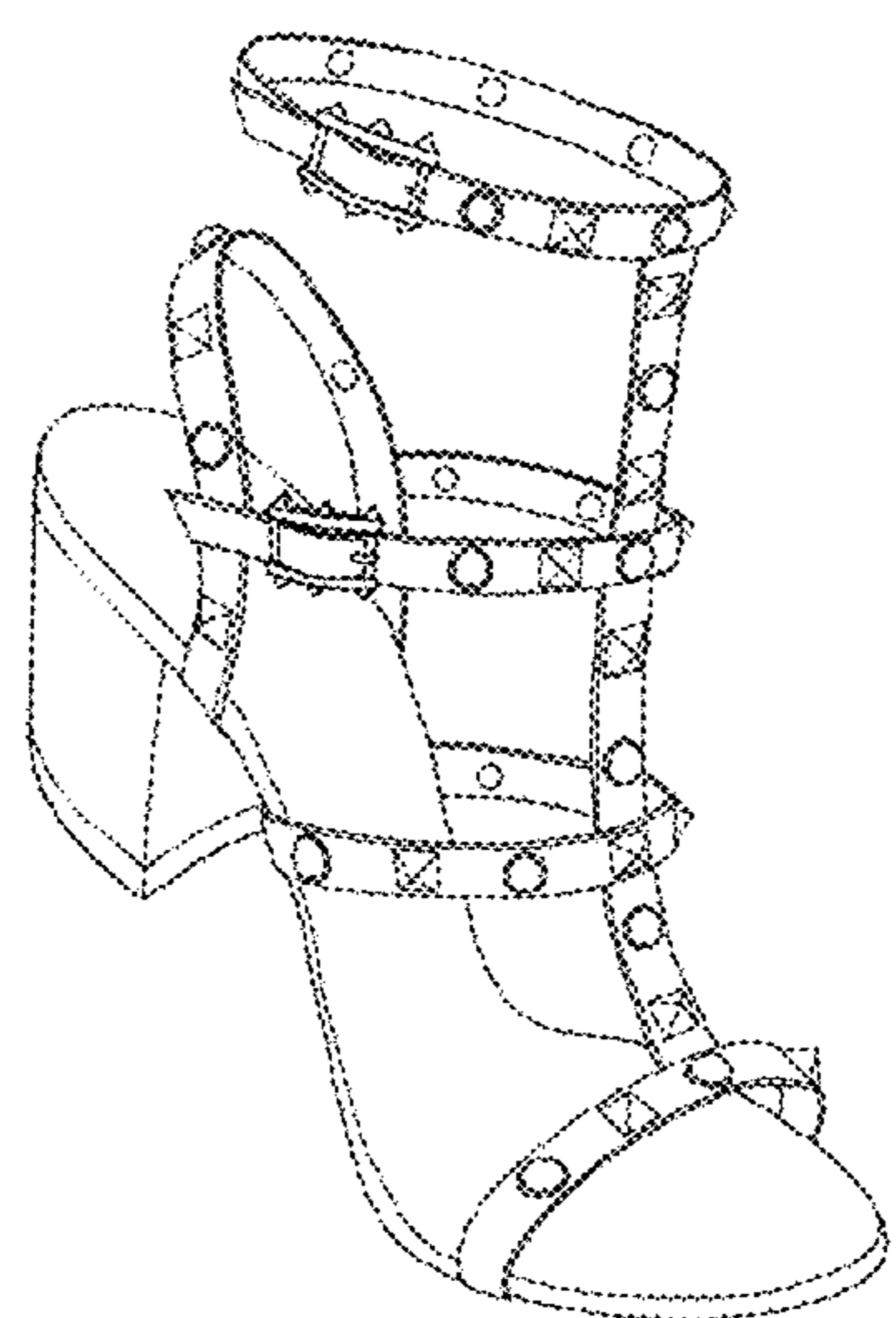

(56)

References Cited

U.S. PATENT DOCUMENTS

D129,706 S *	9/1941	Grossman	D2/932
D131,119 S *	1/1942	Hirshorn	D2/922
D131,170 S *	1/1942	Wolock	D2/932
D131,545 S	3/1942	Vivier	
D132,292 S	5/1942	Benton	
D149,695 S	5/1948	Sandler	
D158,331 S	4/1950	Sandler	
D158,395 S	5/1950	Liberty	
D161,097 S *	12/1950	Frankel	D2/920
D162,168 S *	2/1951	Ish-Shalom	D2/918
D162,185 S *	2/1951	Lacek	D2/927
D162,186 S *	2/1951	Lacek	D2/932
3,093,916 A *	6/1963	Hiestand	A43B 3/106 36/9 R
D279,326 S	6/1985	Foldes	
D344,624 S *	3/1994	Schnel	D2/629
D486,296 S *	2/2004	Morrison	D2/917
D525,415 S *	7/2006	Kelsey	D2/925
D552,841 S *	10/2007	Choi	D2/971
D583,538 S *	12/2008	Choi	D2/925
D628,787 S *	12/2010	Guers-Neyraud	D2/929
D632,061 S *	2/2011	Hardy	D2/929
D632,470 S *	2/2011	Guers-Neyraud	D2/929
D730,030 S *	5/2015	Della Valle	D2/939
D735,981 S *	8/2015	Louboutin	D2/939
D738,598 S *	9/2015	Sassi	D2/929
D738,599 S *	9/2015	Sassi	D2/929
D740,000 S *	10/2015	Sassi	D2/929
D764,775 S *	8/2016	Sassi	D2/929
D764,776 S *	8/2016	Sassi	D2/929
D765,954 S *	9/2016	Sassi	D2/929
D766,557 S *	9/2016	Sassi	D2/929
D769,589 S *	10/2016	Sassi	D2/931
D774,737 S *	12/2016	Sassi	D2/929
D775,797 S *	1/2017	Sassi	D2/929
D779,796 S *	2/2017	Sassi	D2/929

OTHER PUBLICATIONS

5 Bambole , posted at amazon.co.jp, earliest date available Apr. 4, 2010, [online], acquired on Apr. 13, 2017. Available from Internet, <URL: <https://www.amazon.co.jp/5-Bambole-Luna-DaGosto-Analog/dp/B00GMC8TO4>>.*

Saint Laurent: Star-Studded Leather Fringe Sandal, posted at modesens.com, first seen Dec. 2015, [online], acquired on Apr. 14, 2017. Available from Internet, <URL: <https://modesens.com/product/SAINT-LAURENT-Star-Studded-Leather-Fringe-Sandal-Black-271581/>>.*

Marc by Marc Jacobs Women's Mouse Ballerina Flat, posted at amazon.com, earliest date available Jun. 11, 2013, [online], acquired on Apr. 14, 2017. Available from Internet, <URL: <https://www.amazon.com/Marc-Jacobs-Womens-Mouse-Ballerina/dp/B00BLZA7AG>>.*

Valentino Rockstud Flat, posted at nordstrom.com, earliest date reviewed Jun. 26, 2013, [online], acquired Apr. 13, 2017. Available from internet, <URL: <http://shop.nordstrom.com/s/valentino-rockstud-flat/3477176?origin=keywordsearch-personalizedsort&fashioncolor=BLACK%20LEATHER>>.

Valentino Rockstud Pointy Toe Pump, posted at nordstrom.com, earliest date reviewed Jan. 19, 2011, [online], acquired on Apr. 13, 2017. Available from Internet, <URL: <http://shop.nordstrom.com/s/valentino-rockstud-pointy-toe-pump-women/3139048>>.

Valentino Rockstud T-Strap Pump, posted at nordstrom.com, earliest date reviewed Dec. 10, 2012, [online], acquired on Apr. 13, 2017. Available from Internet, <URL: <http://shop.nordstrom.com/s/valentino-rockstud-t-strap-pump-women/3171736>>.

Valentino Rockstud 100mm Light Pink Patent Leather Slingback Pump, posted at valentino-outlet.cc, earliest date reviewed Jul. 27, 2014, [online], acquired on Apr. 13, 2017. Available from Internet, <URL: http://www.valentino-outlet.cc/valentino-rockstud-100mm-light-pink-patent-leather-slingback-pump-p-16.html?page=2&number_of_uploads=0>.

* cited by examiner

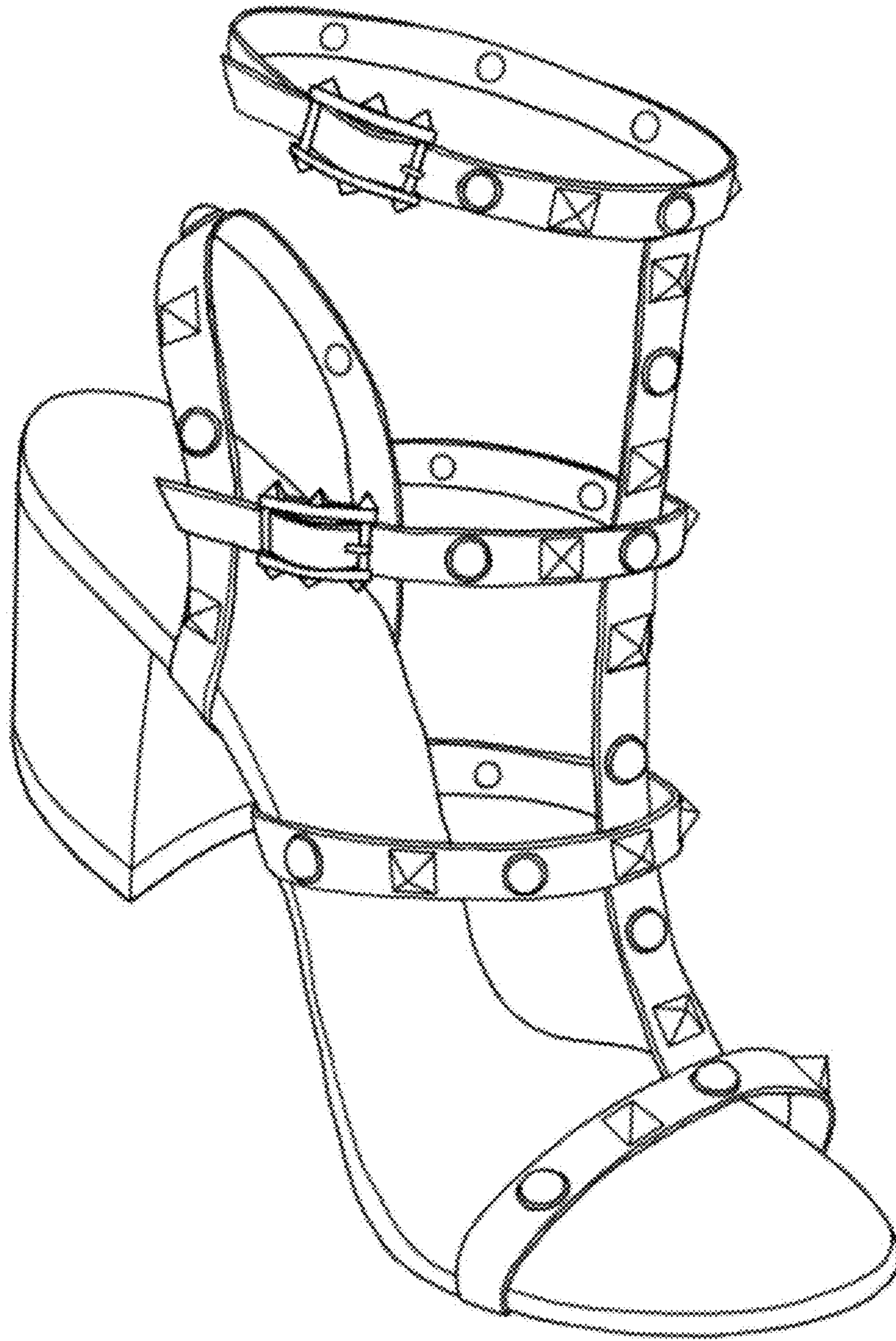

FIG. 1

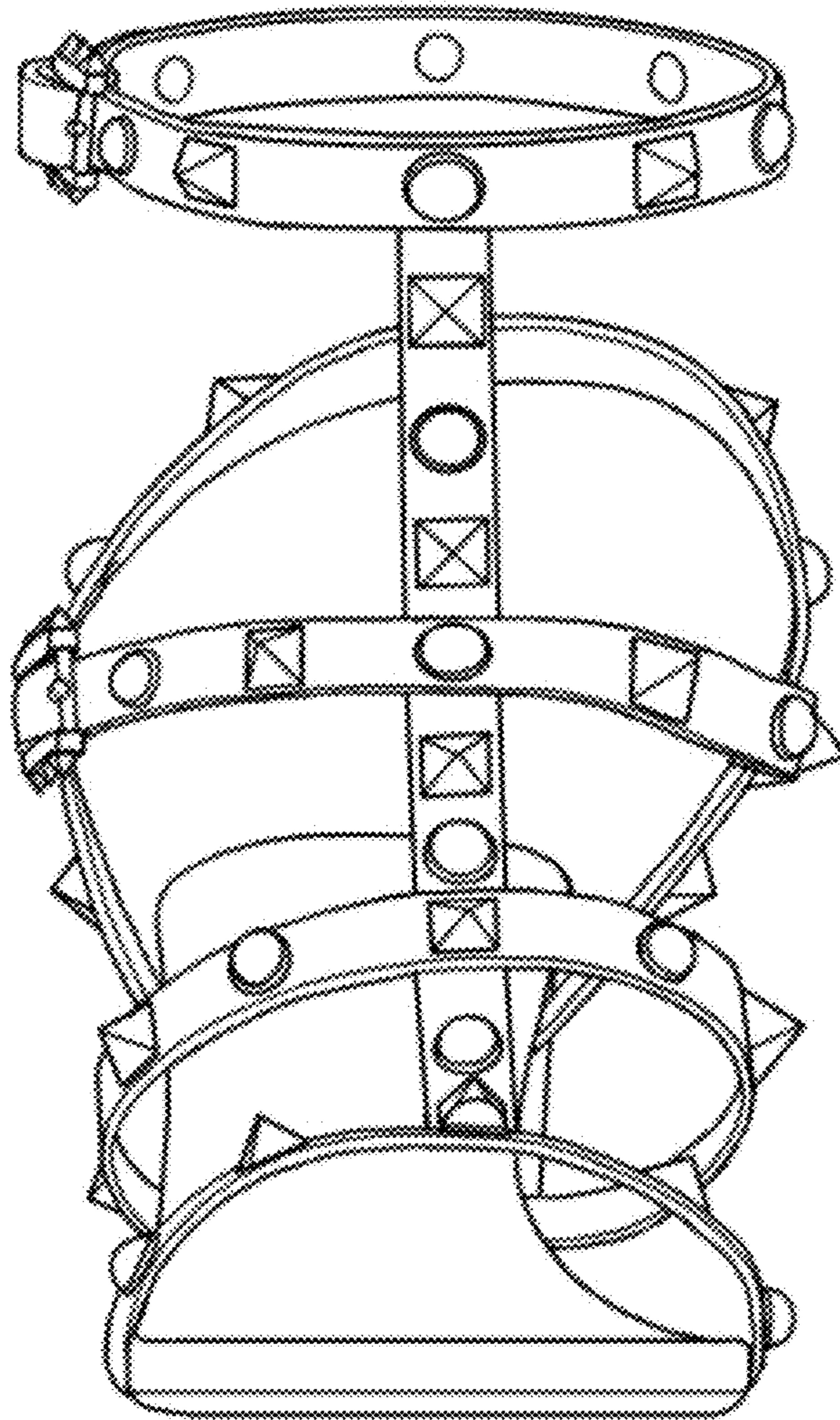

FIG. 2

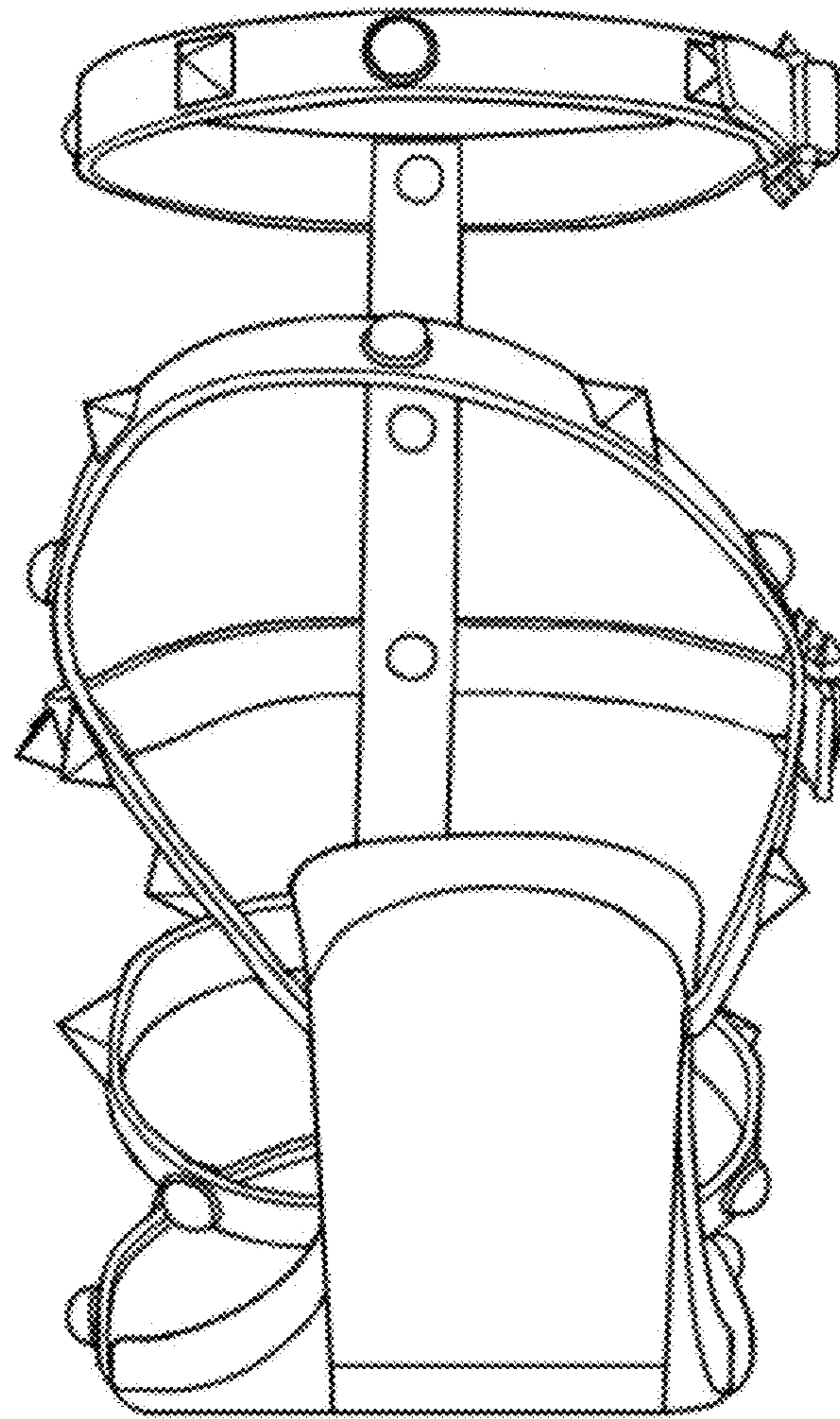

FIG. 3

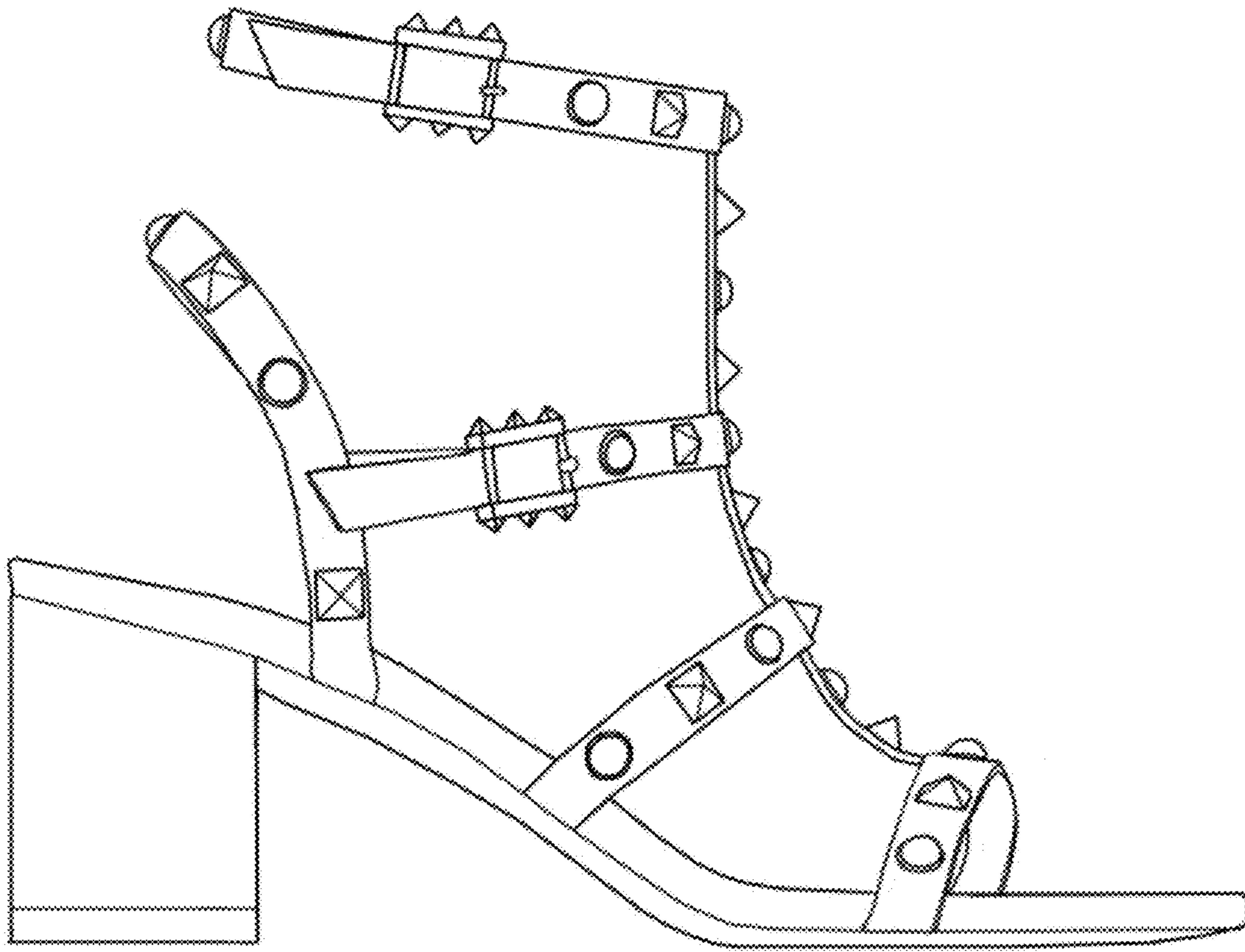

FIG. 4

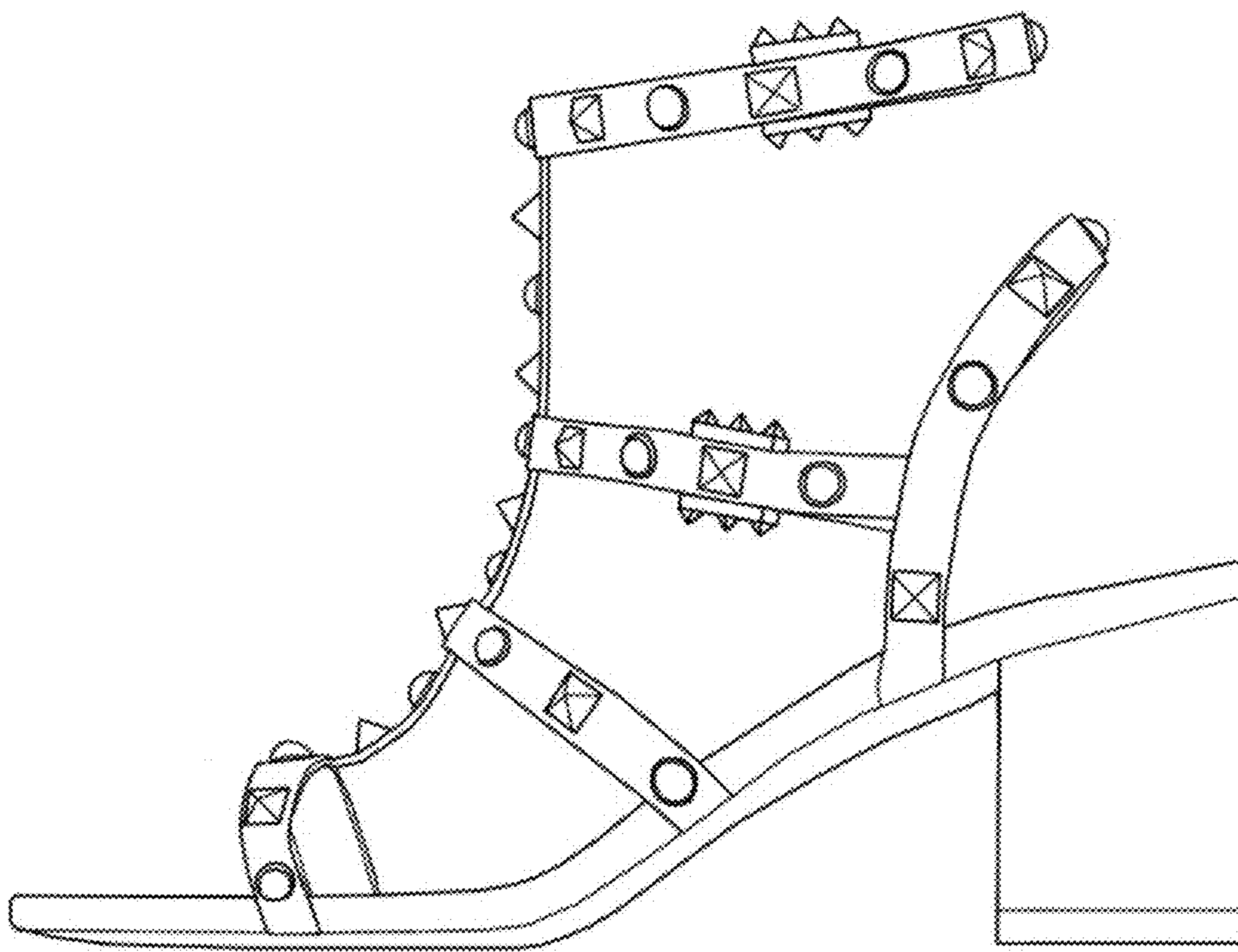

FIG. 5

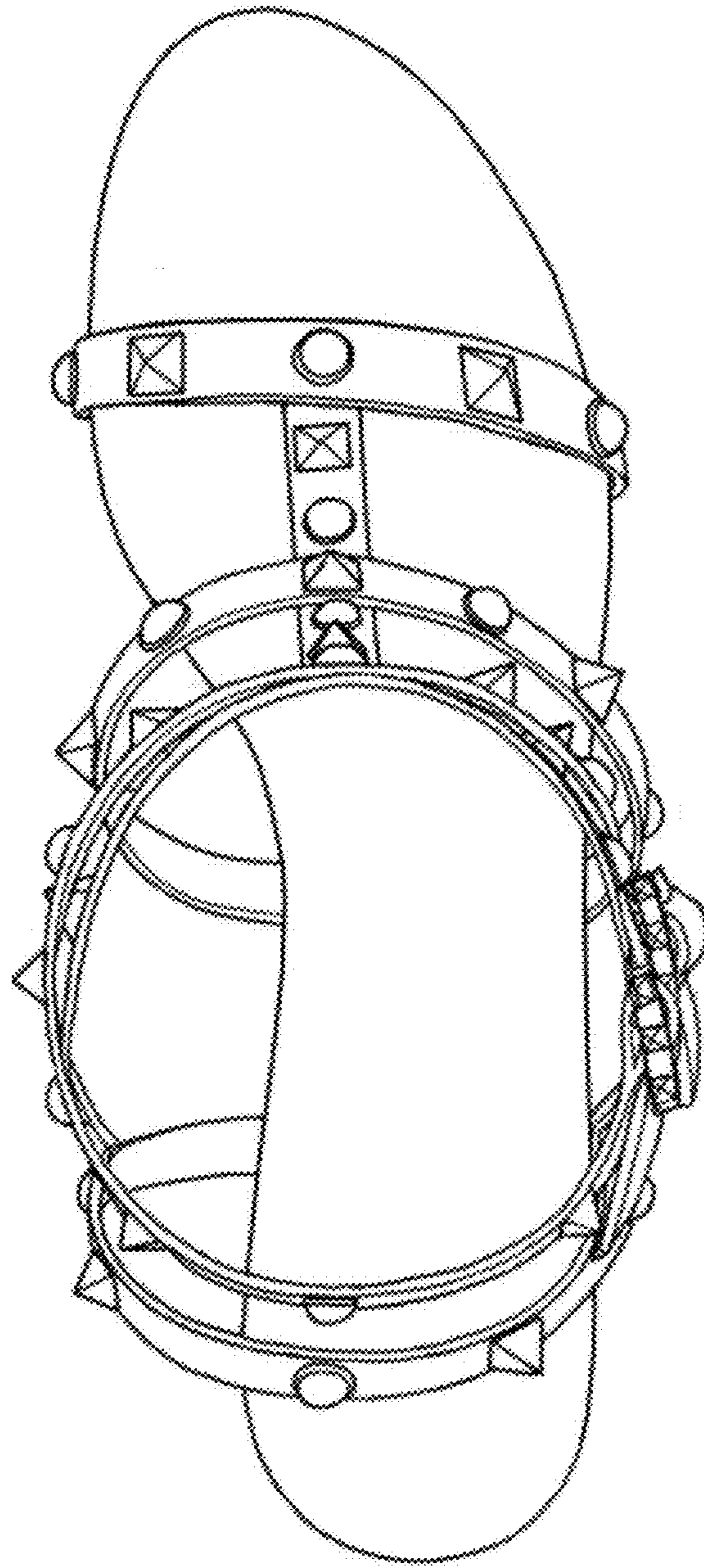

FIG. 6

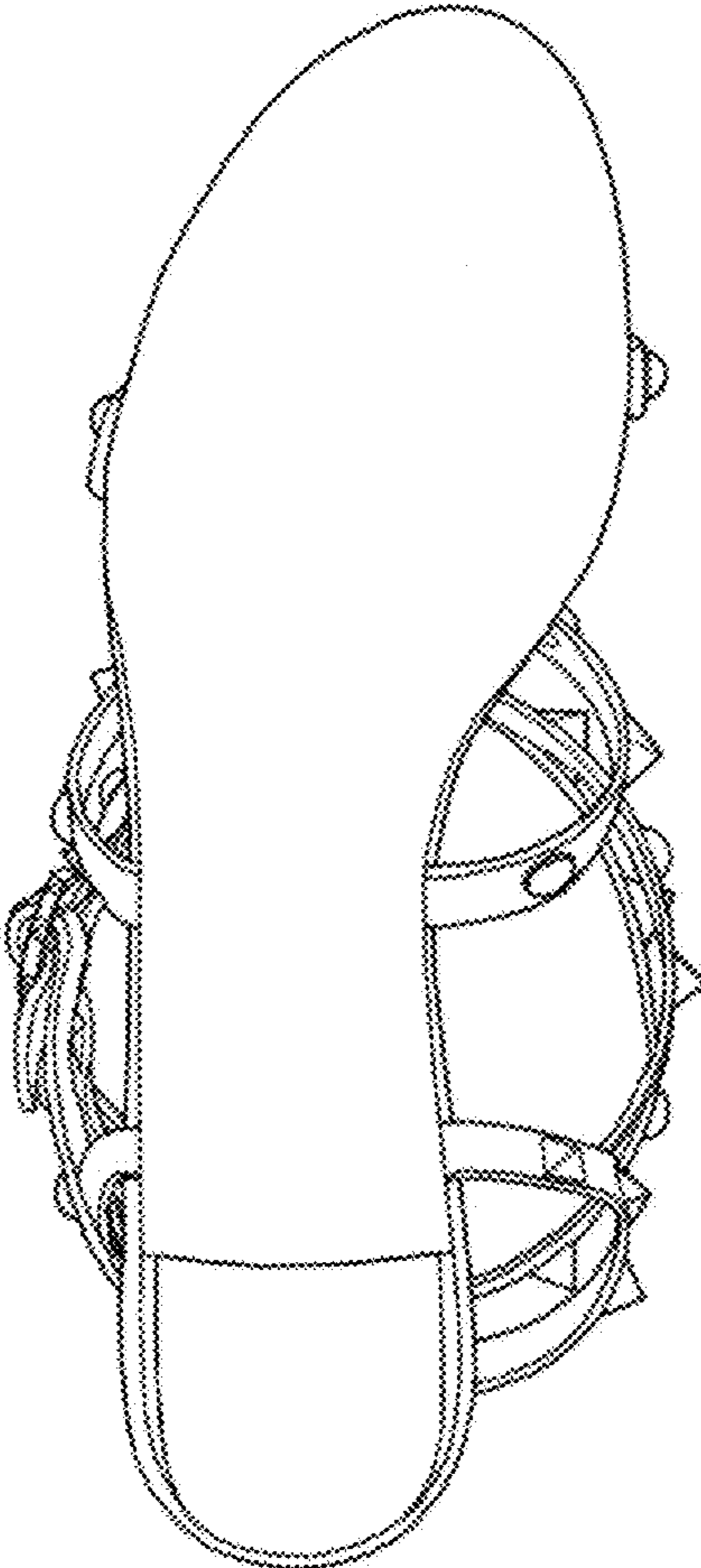

FIG. 7