



US00D811677S

(12) **United States Design Patent** (10) **Patent No.:** **US D811,677 S**
Goodman et al. (45) **Date of Patent:** **** Feb. 27, 2018**

(54) **SINK CRADLE**
(71) Applicant: **Spectrum Diversified Designs, LLC**,
Streetsboro, OH (US)
(72) Inventors: **Aaron Goodman**, Beachwood, OH
(US); **Xuemei Yuan**, Stow, OH (US)
(73) Assignee: **Spectrum Diversified Designs, LLC**,
Streetsboro, OH (US)
(**) Term: **15 Years**
(21) Appl. No.: **29/596,793**
(22) Filed: **Mar. 10, 2017**
(51) **LOC (11) Cl.** **07-05**
(52) **U.S. Cl.**
USPC **D32/55**
(58) **Field of Classification Search**
USPC D32/55, 276, 3; D6/510, 525; D30/133;
211/41.5, 41.4, 41.3, 41.8; 361/679.4;
312/311, 333, 334.4; D7/354, 629
CPC .. A47L 15/505; A47L 15/503; A47L 15/0013;
A47L 19/02; A47L 19/04; A47J 47/20
See application file for complete search history.

D731,728 S * 6/2015 Evans D32/55
D734,818 S * 7/2015 Goodman D19/90
D759,990 S * 6/2016 Goodman D6/566
D762,035 S * 7/2016 Cooper D32/55
D762,397 S * 8/2016 Goodman D6/537
D762,934 S * 8/2016 Evans D32/55
D773,846 S * 12/2016 Chang D6/537

OTHER PUBLICATIONS

U.S. Appl. No. 29/596,796, filed Mar. 10, 2017 entitled: Sink Cradle.

* cited by examiner

Primary Examiner — Austin Murphy

(74) *Attorney, Agent, or Firm* — Tucker Ellis LLP;
Patrick F. Clunk

(57) **CLAIM**

The ornamental design for a sink cradle, as shown and described.

DESCRIPTION

FIG. 1 is a perspective view of a sink cradle showing our new design.

FIG. 2 is a front view thereof.

FIG. 3 is a rear view thereof.

FIG. 4 is a right side view thereof.

FIG. 5 is a left side view thereof.

FIG. 6 is a top view thereof; and,

FIG. 7 is a bottom view thereof.

The broken lines shown herein are for illustrative purposes only and form no part of the claimed design.

1 Claim, 4 Drawing Sheets

(56) **References Cited**

U.S. PATENT DOCUMENTS

D453,651 S * 2/2002 Snell D6/537
D532,234 S * 11/2006 Snell D6/567
D566,919 S * 4/2008 Snell D32/55
D612,648 S * 3/2010 Guindi D6/525
D635,383 S * 4/2011 Yang D6/525
D675,049 S * 1/2013 Goodman D6/513
D718,510 S * 11/2014 Goodman D32/55
D723,760 S * 3/2015 Goodman D32/55
D723,761 S * 3/2015 Goodman D32/55

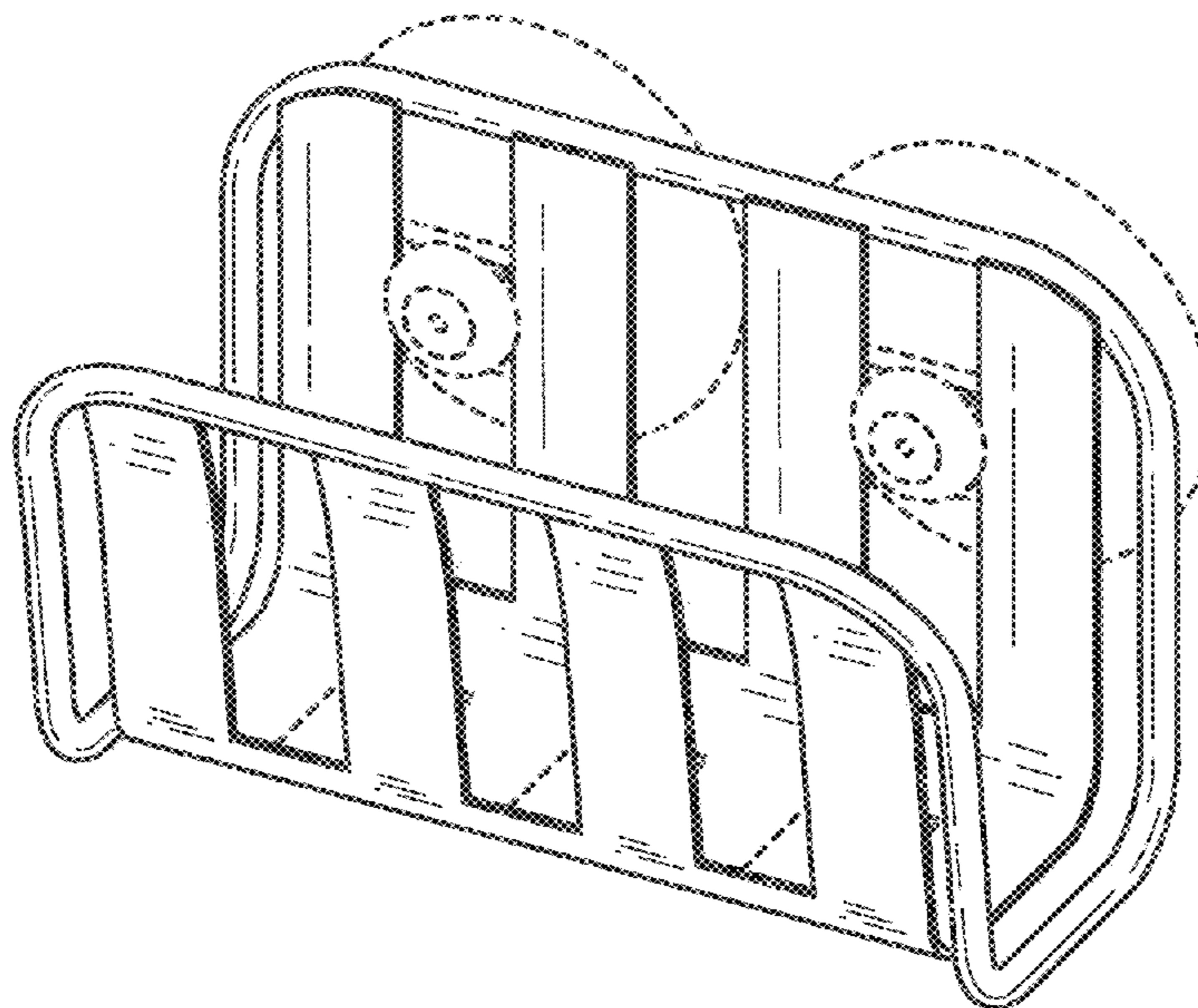

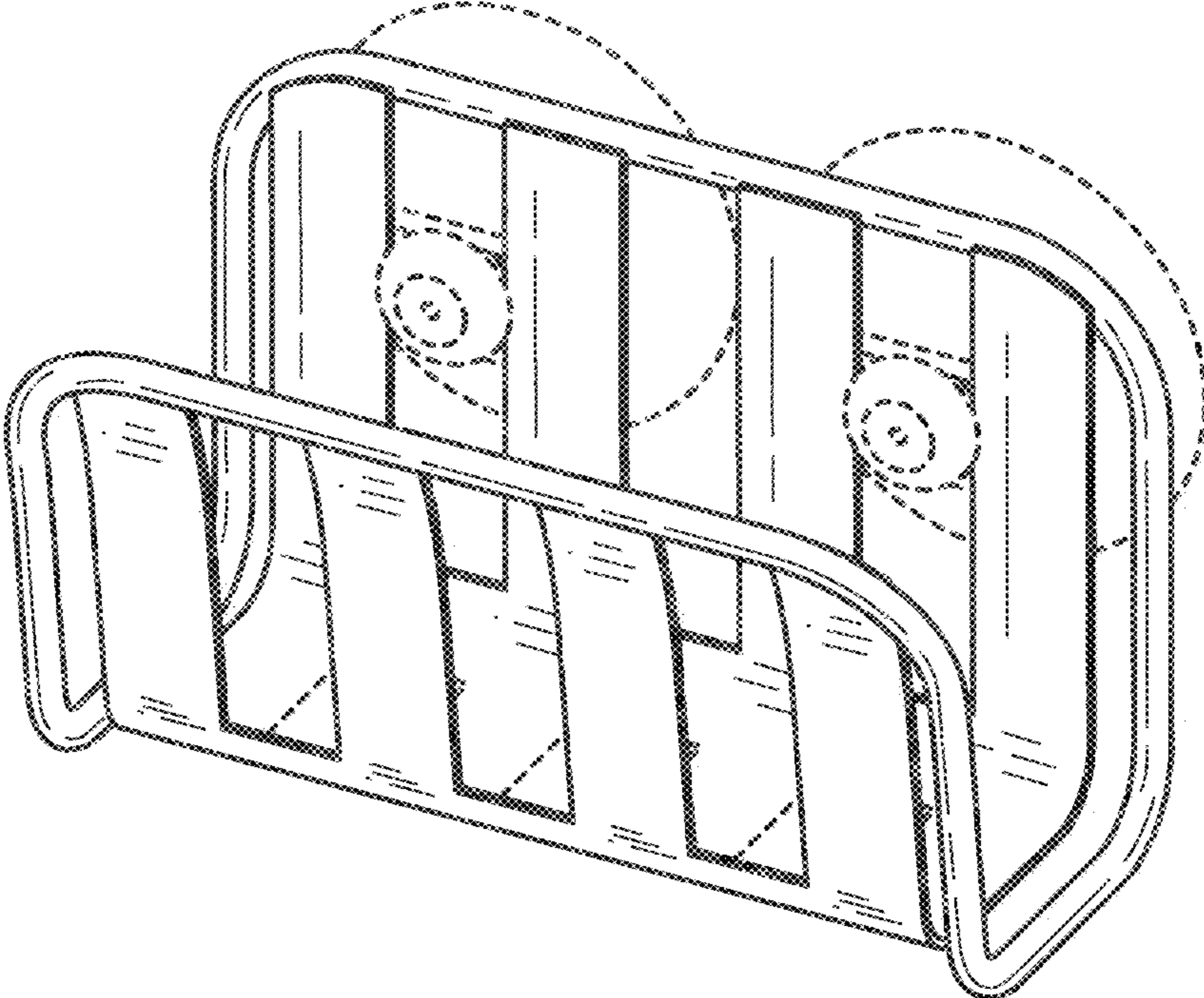

FIG. 1

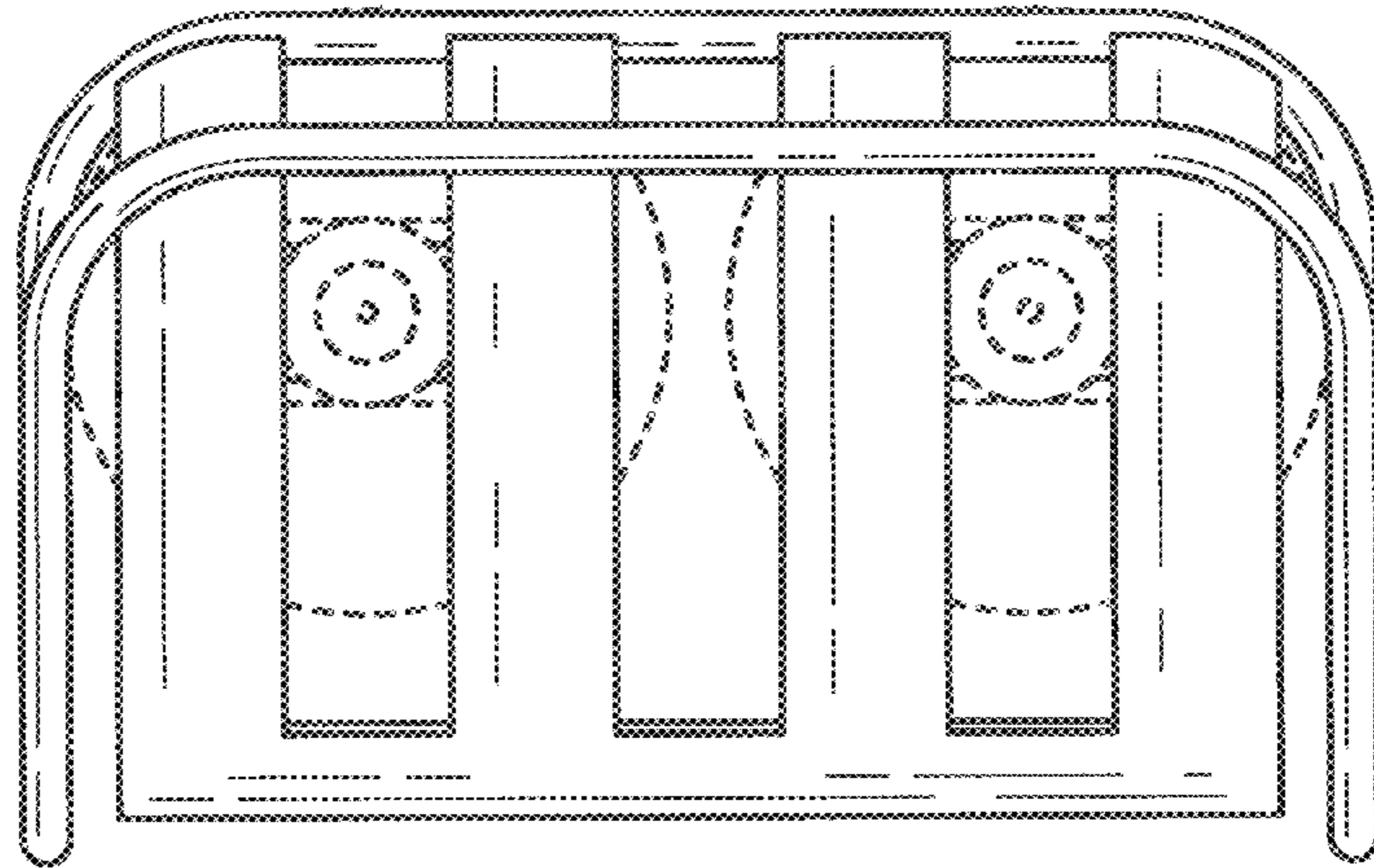

FIG. 2

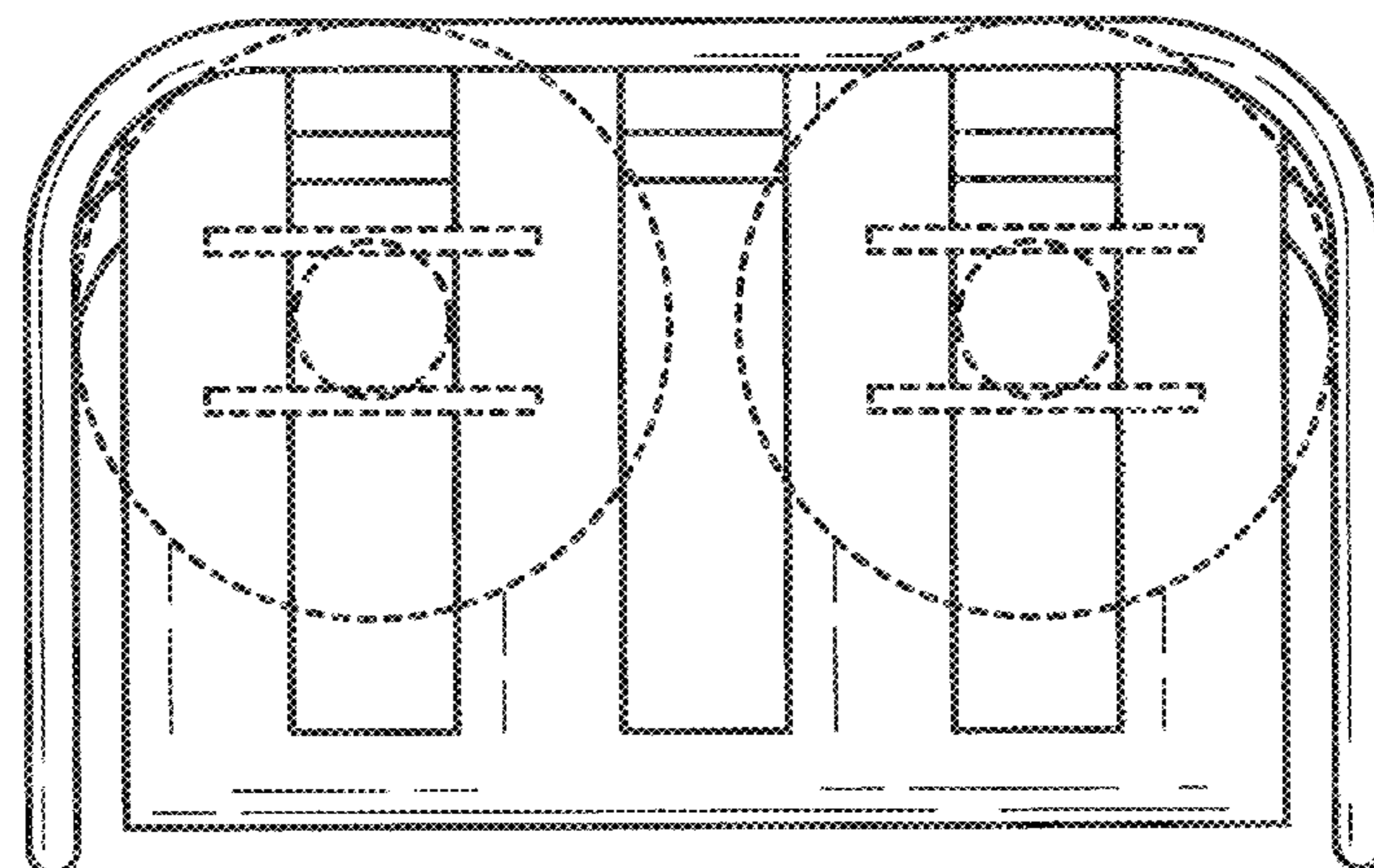

FIG. 3

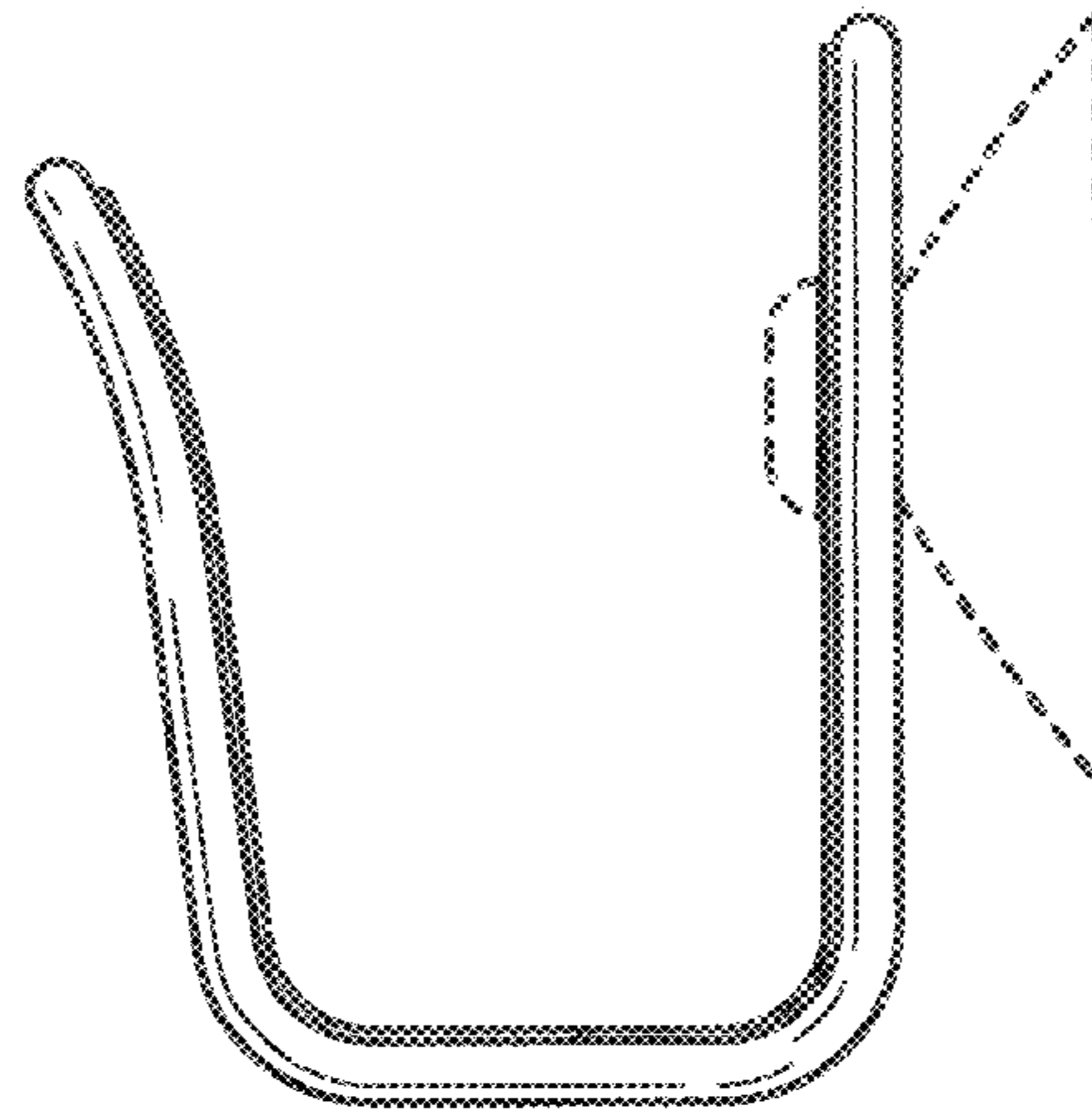

FIG. 4

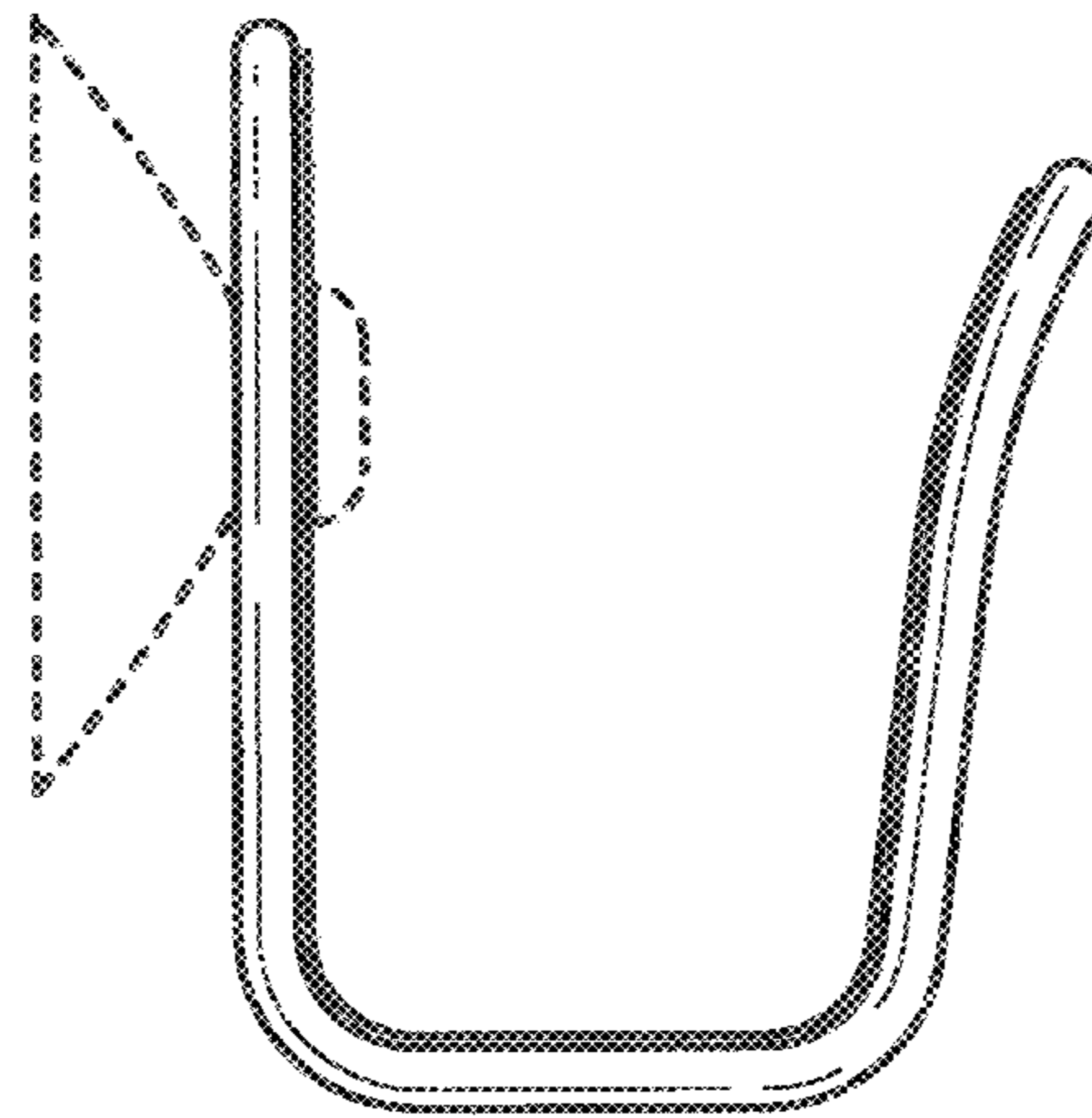

FIG. 5

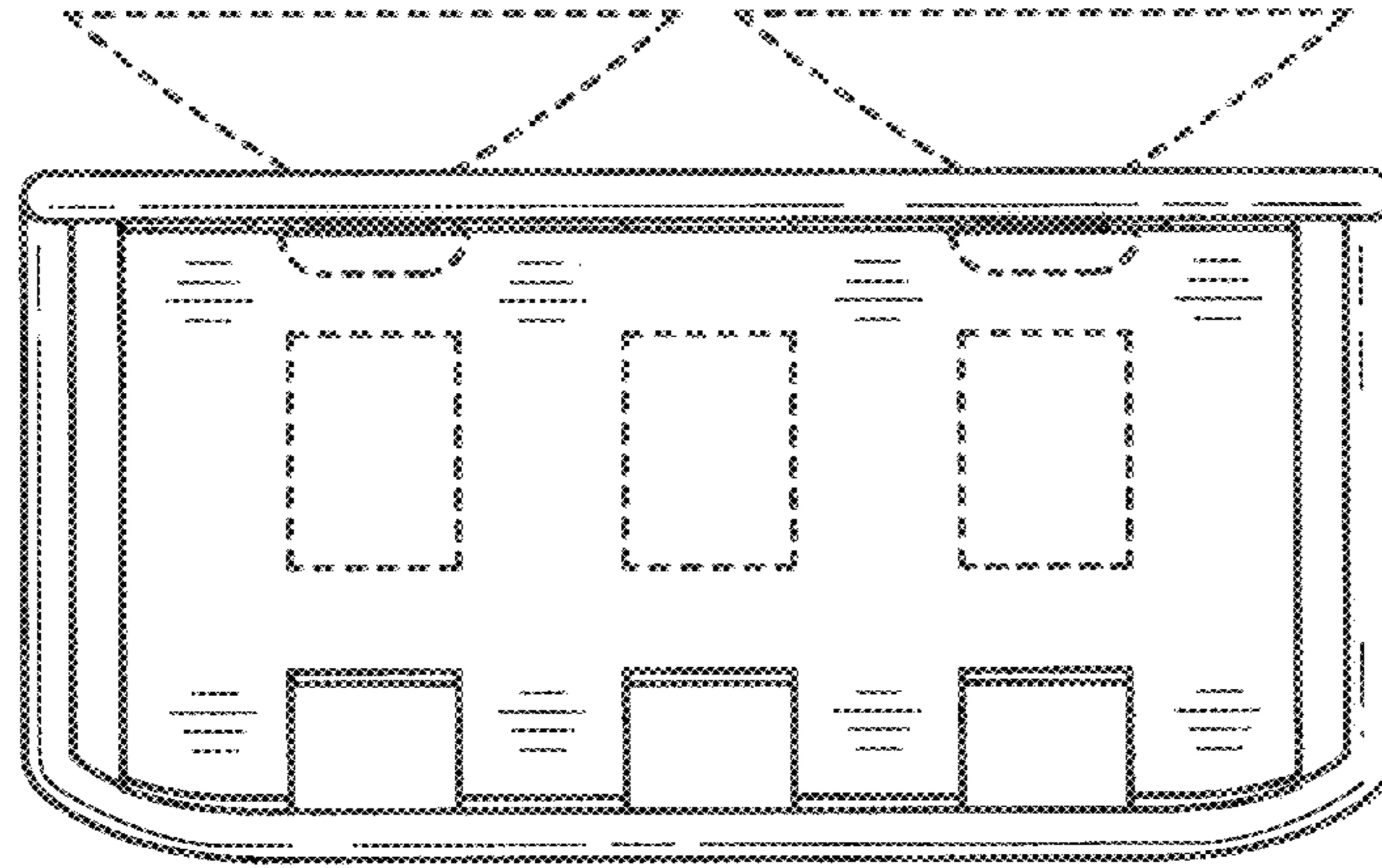

FIG. 6

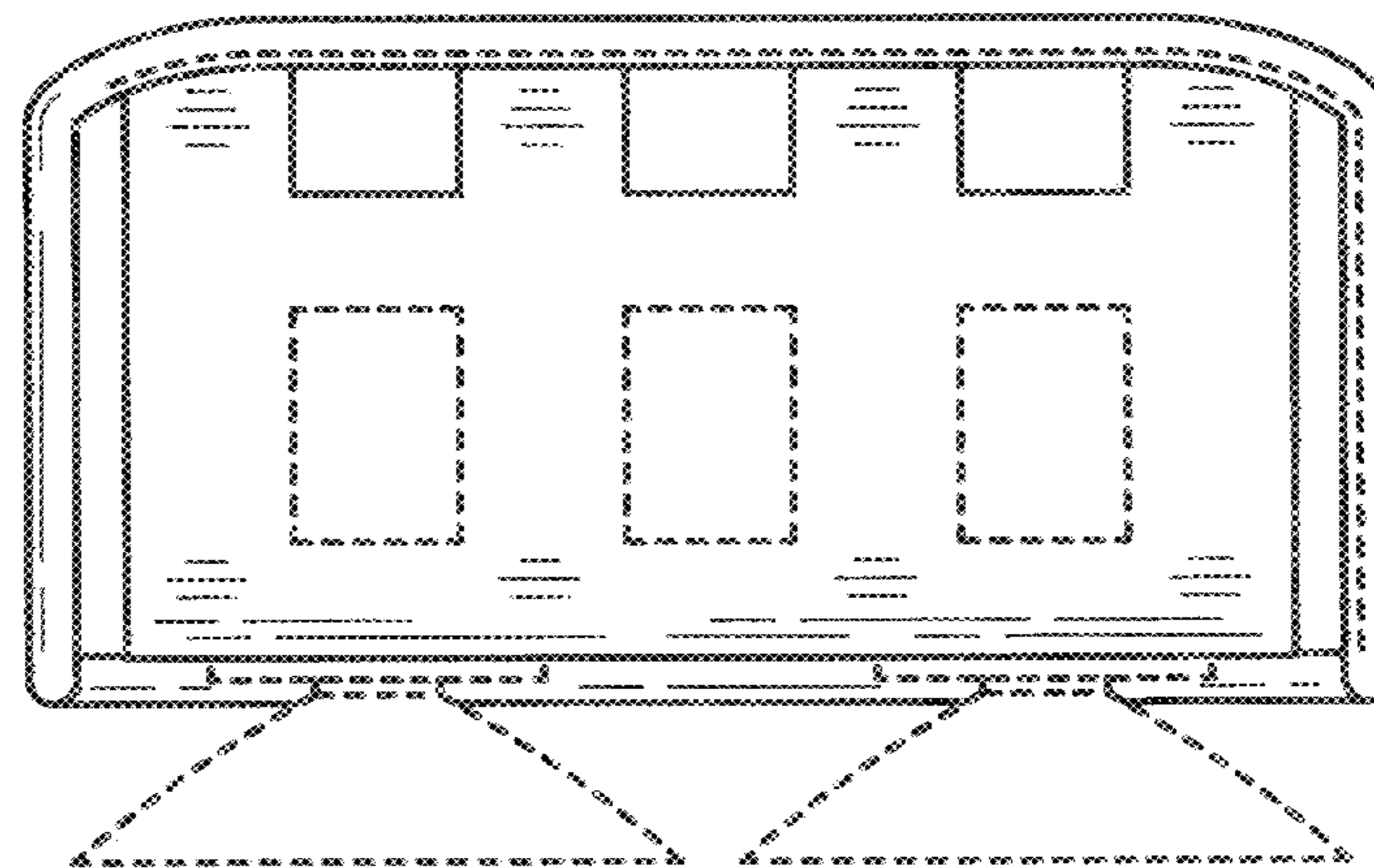

FIG. 7