



US00D811577S

(12) **United States Design Patent**
Yang

(10) **Patent No.:** **US D811,577 S**
(45) **Date of Patent:** **** Feb. 27, 2018**

- (54) **CEILING FAN HOUSING**
- (71) Applicant: **YOUNGO LIMITED**, Hong Kong (CN)
- (72) Inventor: **Helen Yang**, Rowland Heights, CA (US)
- (73) Assignee: **YOUNGO LIMITED**, Central (HK)
- (**) Term: **15 Years**
- (21) Appl. No.: **29/568,601**
- (22) Filed: **Jun. 20, 2016**
- (51) **LOC (11) Cl.** **23-03**
- (52) **U.S. Cl.**
USPC **D23/411; D26/59**
- (58) **Field of Classification Search**
USPC D23/355, 370-376, 378, 380-384,
D23/386-387, 377, 379, 385, 411-414;
D26/59
CPC F04D 25/088; F21V 33/0096
See application file for complete search history.

- D745,959 S * 12/2015 Ertze D23/411
- D773,637 S * 12/2016 Ertze D23/377
- D779,052 S * 2/2017 Gajewski D23/411

OTHER PUBLICATIONS

Craftmade K11256 Sonnet Ceiling Fan, date first available Sep. 3, 2015, amazon.com, site visited Aug. 31, 2017, Copyright © 1996-2017, https://www.amazon.com/dp/B014UOZCE/ref=psdc_404433011_t1_B00VF1WECK.*

Savoy House 56-870-3BK-SNB Muir 56" 3 Blade Ceiling Fan, date first available Jan. 27, 2015, amazon.com, site visited Aug. 31, 2017, Copyright © 1996-2017, https://www.amazon.com/Savoy-House-56-870-3BK-SNB-Blade-Ceiling/dp/B00SONWYJU/ref=sr_1_2?s=hi&ie=UTF8&qid=1504206260&sr=1-2&keywords=savoy+house+muir.*

* cited by examiner

Primary Examiner — Cathron C Brooks

Assistant Examiner — Sharon S Oum

(74) *Attorney, Agent, or Firm* — Muncy, Geissler, Olds & Lowe, P.C.

(57) **CLAIM**

The ornamental design for a ceiling fan housing, as shown and described.

DESCRIPTION

FIG. 1 is a perspective view of the present design; FIG. 2 is a front view of the present design; FIG. 3 is a rear view of the present design; FIG. 4 is a left side view of the present design; FIG. 5 is a right side view of the present design; FIG. 6 is a top view of the present design; and, FIG. 7 is a bottom view of the present design. The broken lines illustrate portions of the ceiling fan housing and form no part of the claimed design.

1 Claim, 7 Drawing Sheets

(56) **References Cited**

U.S. PATENT DOCUMENTS

- D90,063 S * 6/1933 Dasher D23/377
- D132,865 S * 6/1942 Drollinger D14/209
- D133,120 S * 7/1942 Spear 416/244 R
- D298,454 S * 11/1988 Clyde-Mason D23/377
- D408,515 S * 4/1999 Evans D23/377
- D444,588 S * 7/2001 Lin D26/85
- D451,189 S * 11/2001 Liu D23/377
- D485,002 S * 1/2004 Lin D26/85
- D556,930 S * 12/2007 Ertze D26/59
- D595,401 S * 6/2009 Sturm D23/377
- D603,954 S * 11/2009 Curtin D23/411
- D704,819 S * 5/2014 Wang D23/411
- D704,822 S * 5/2014 Wang D23/411
- D705,970 S * 5/2014 Ertze D26/59

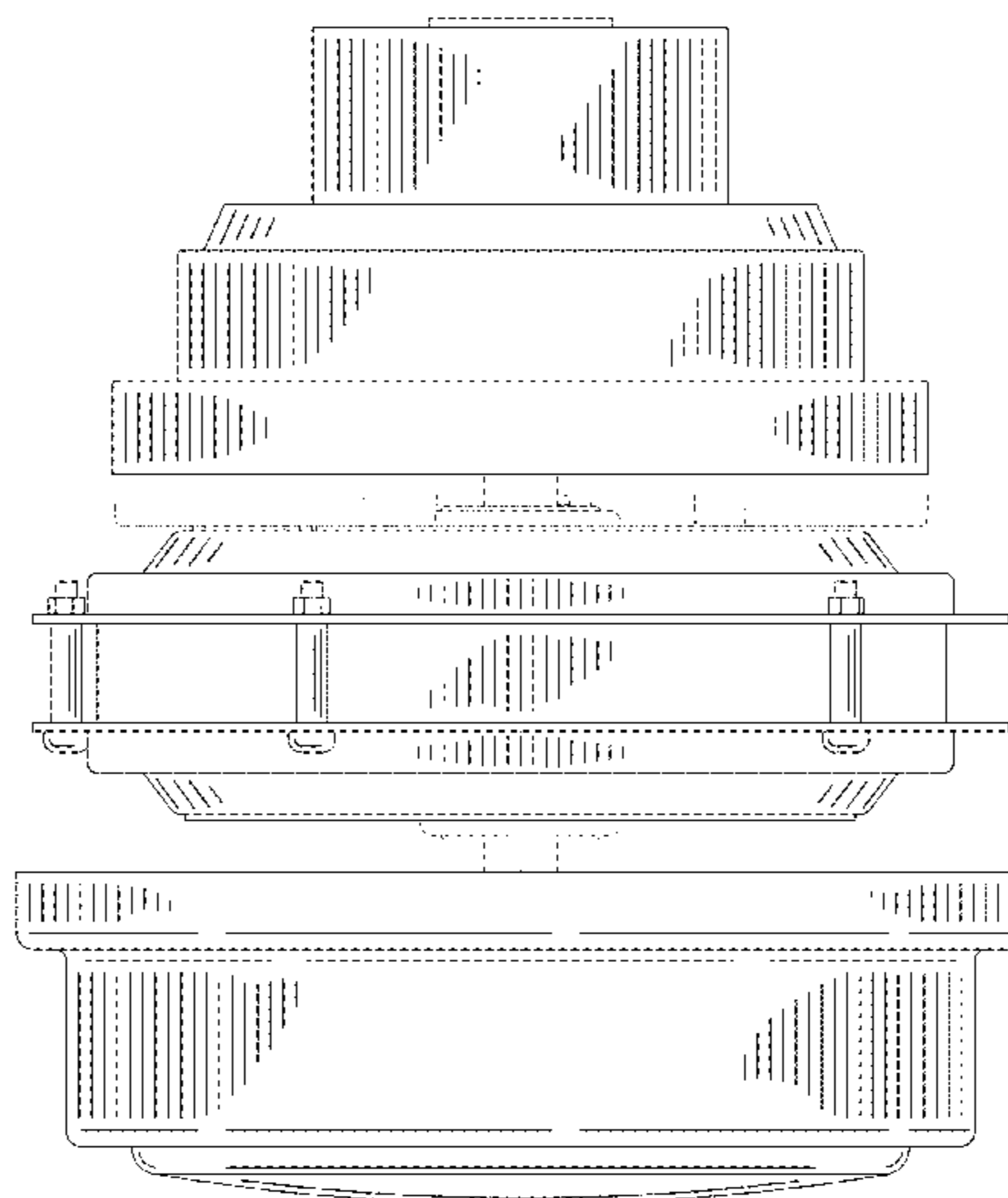
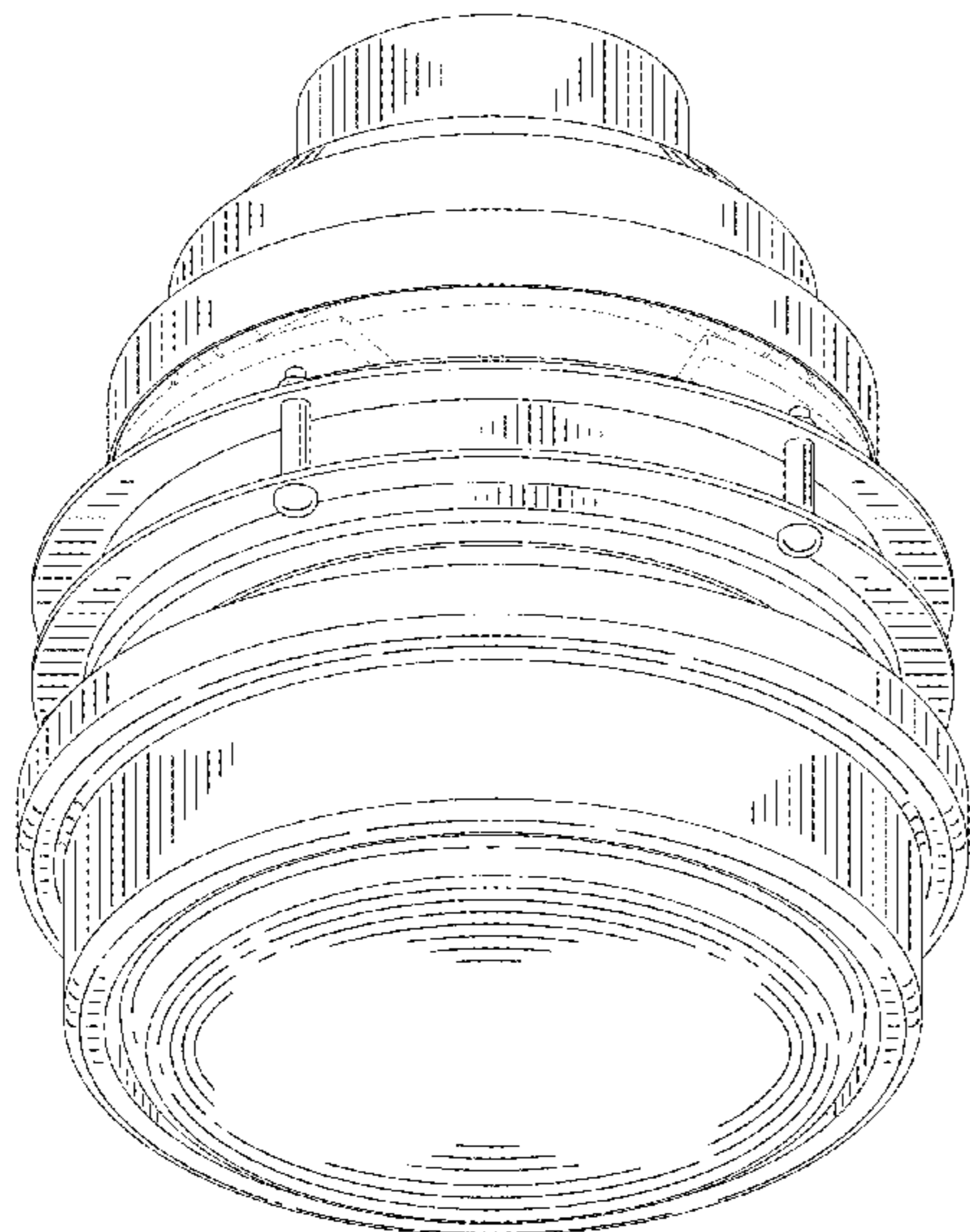

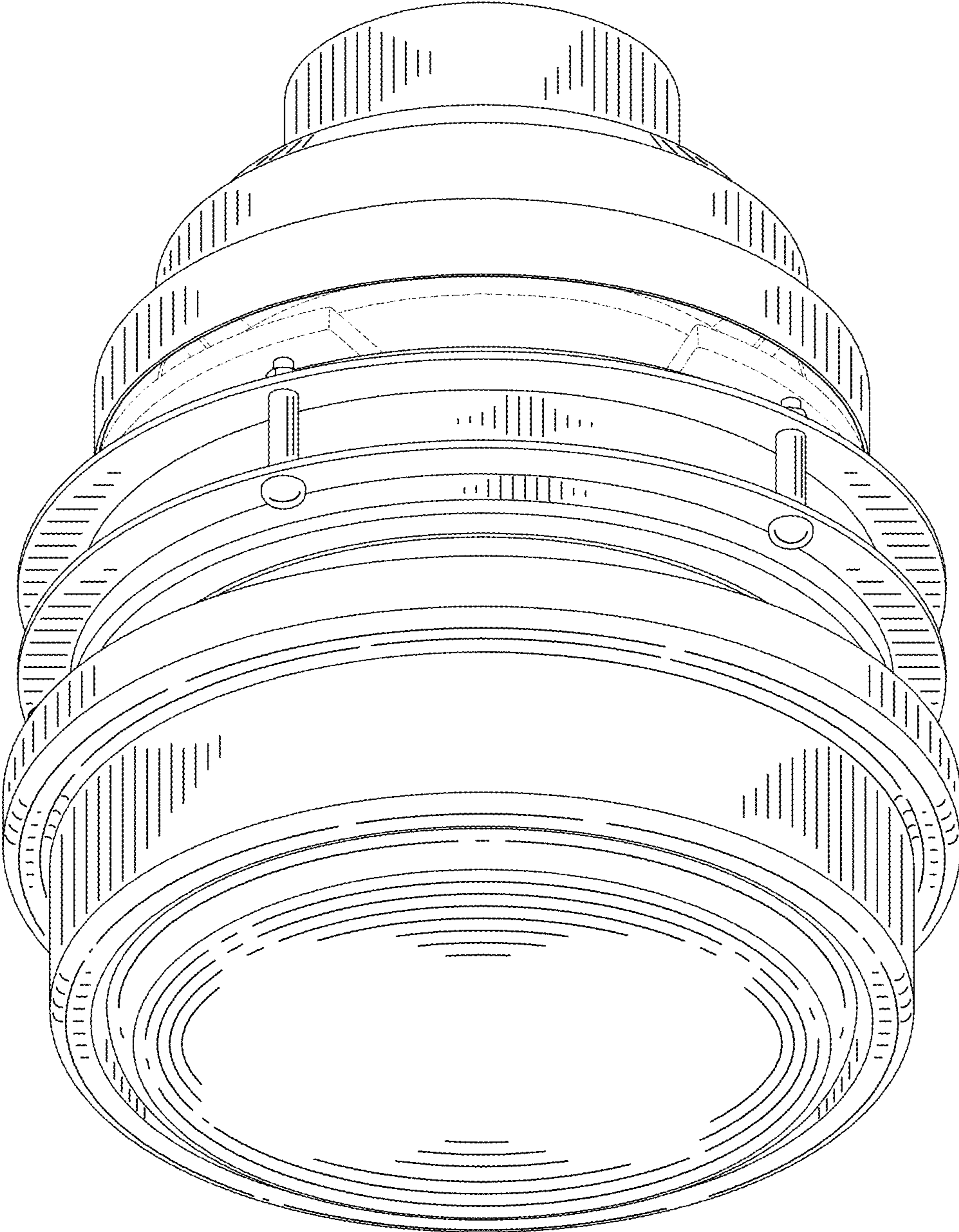

FIG. 1

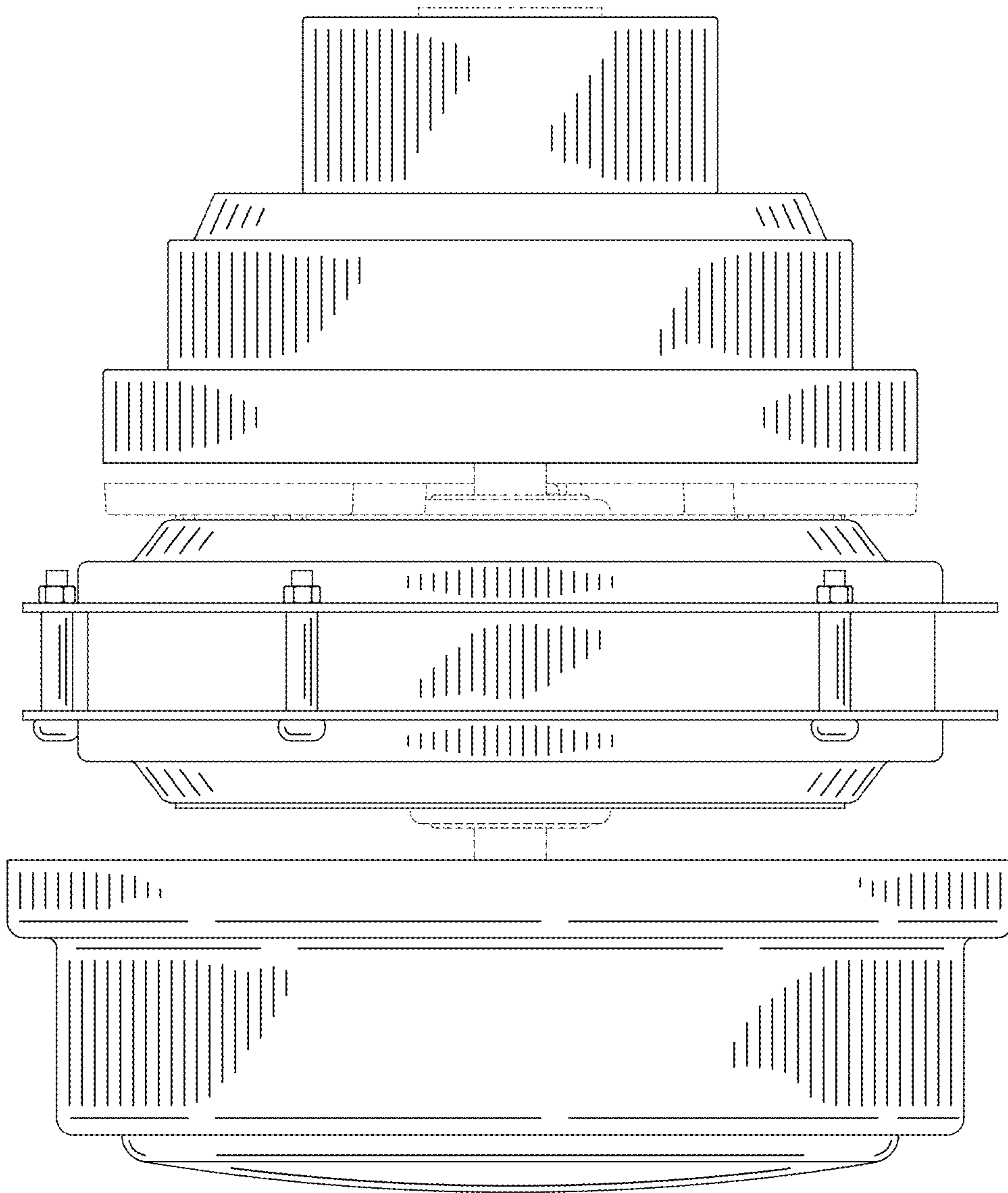

FIG. 2

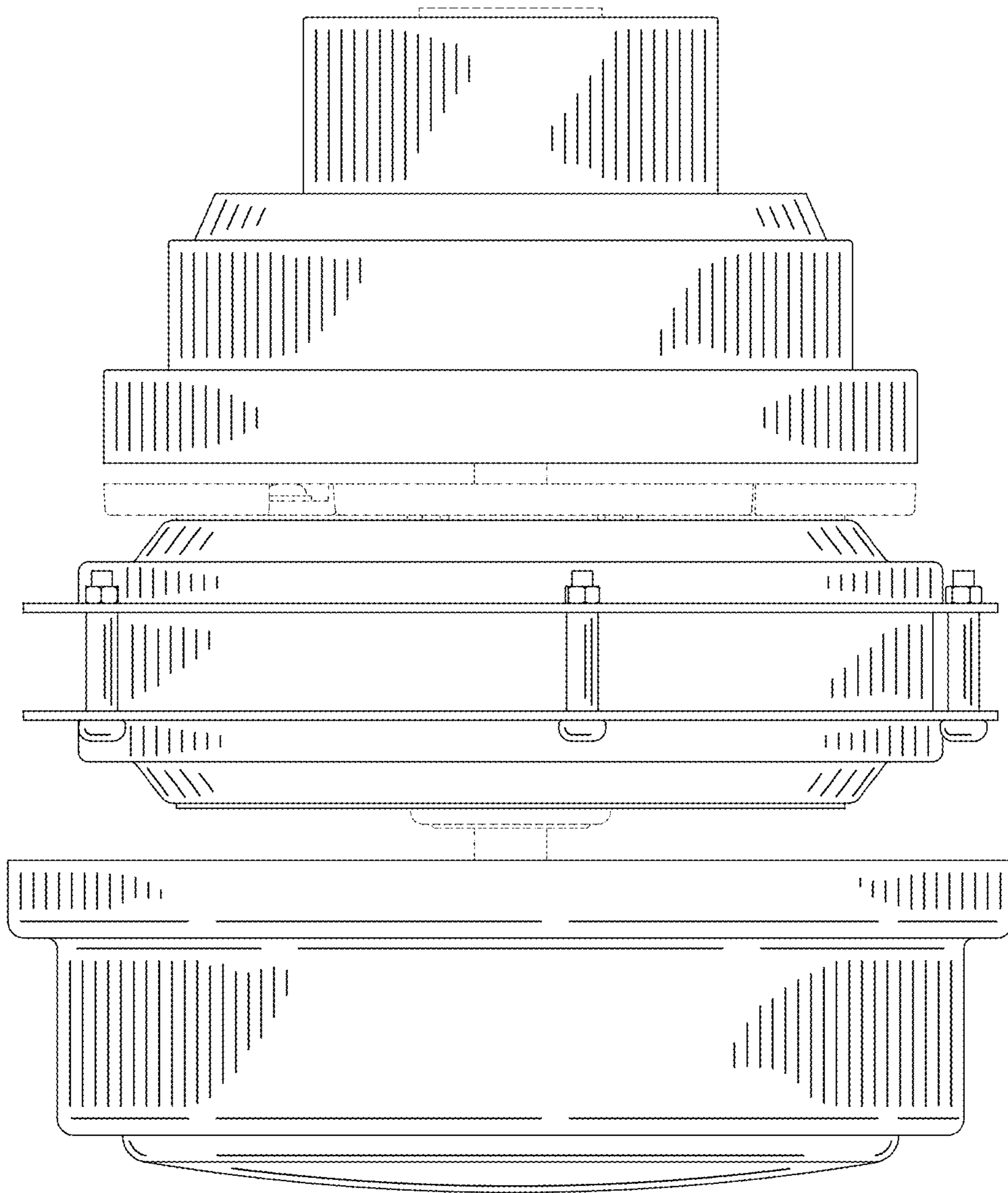

FIG. 3

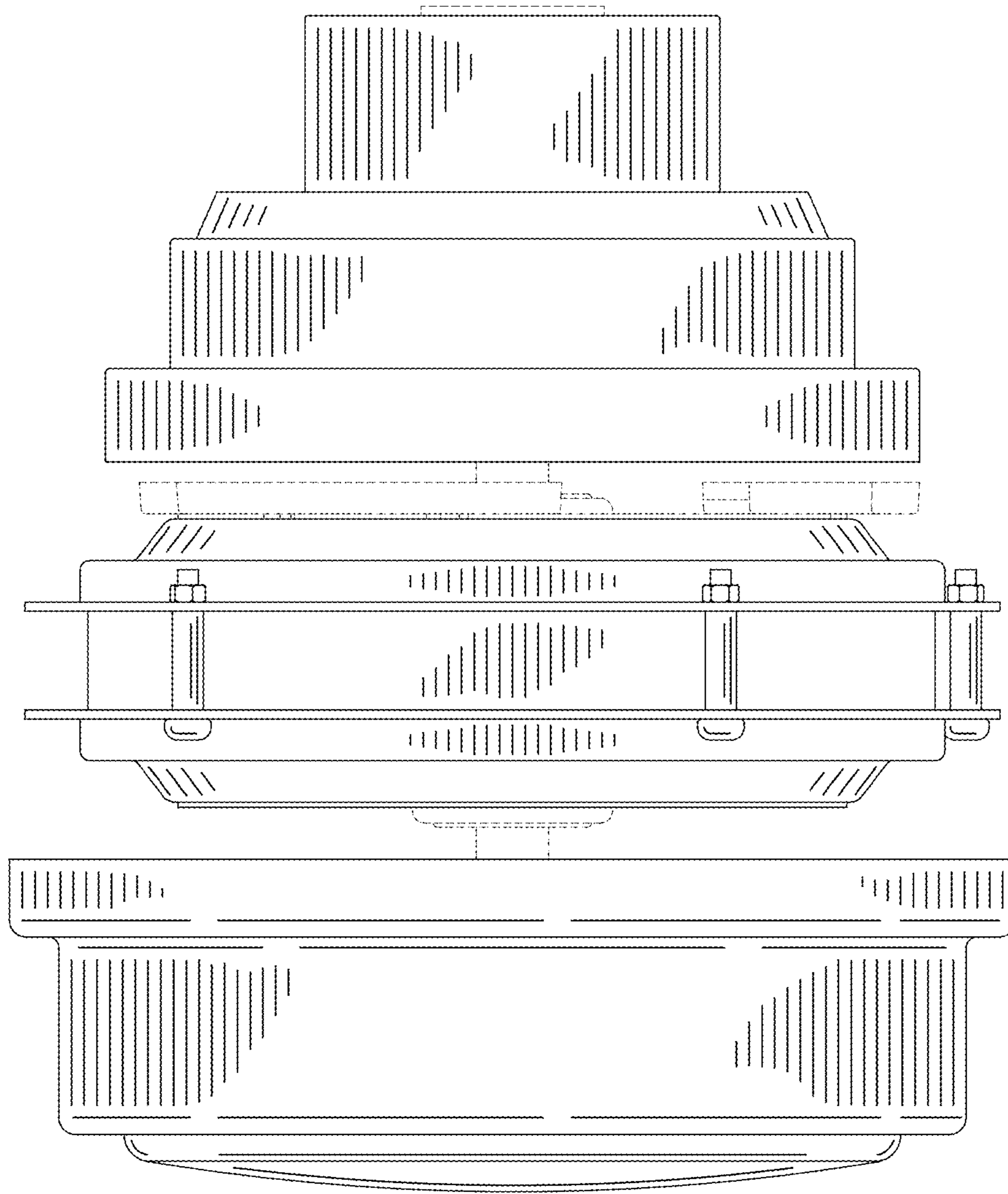

FIG. 5

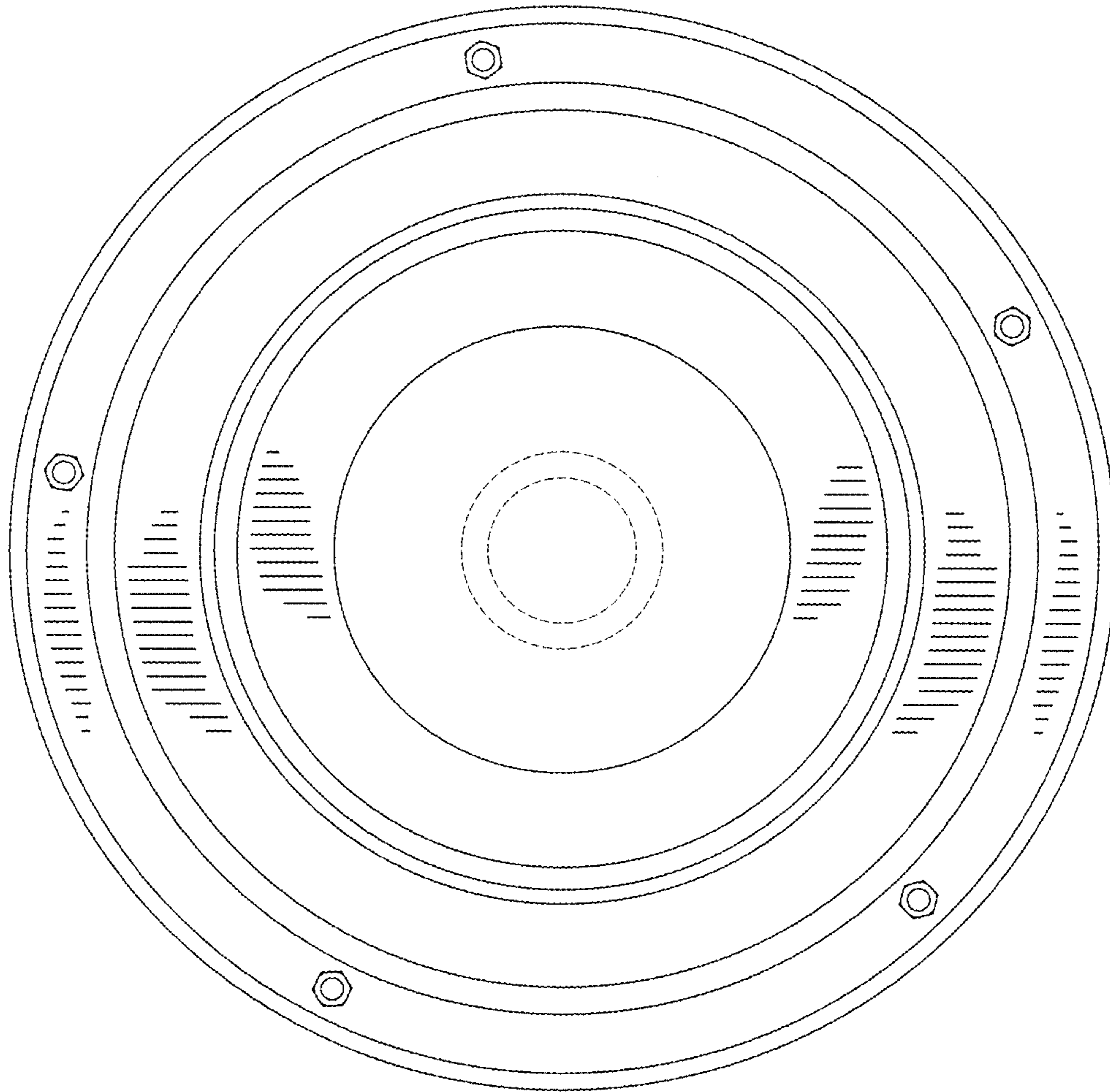

FIG. 6

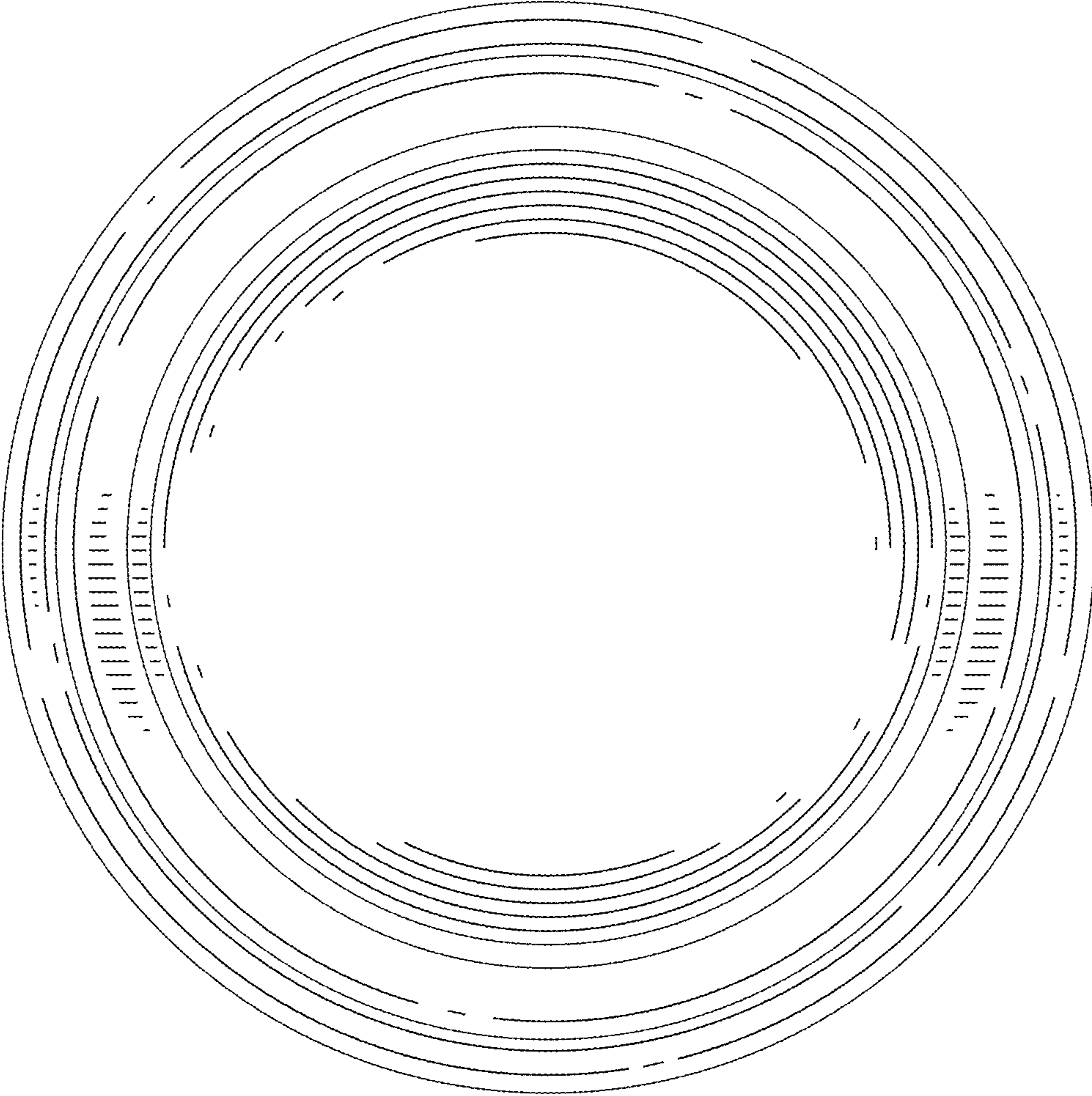

FIG. 7