



US00D811389S

(12) **United States Design Patent**
Kim et al.

(10) **Patent No.:** **US D811,389 S**
(45) **Date of Patent:** **** Feb. 27, 2018**

(54) **ELECTRONIC DEVICE**

(71) Applicant: **Samsung Electronics Co., Ltd.**,
Suwon-si (KR)

(72) Inventors: **Sungkwon Kim**, Seoul (KR); **Chungha Kim**, Seoul (KR); **Kwaneui Hong**,
Yongin-si (KR)

(73) Assignee: **SAMSUNG ELECTRONICS CO., LTD.**, Suwon-si (KR)

(**) Term: **15 Years**

(21) Appl. No.: **29/548,484**

(22) Filed: **Dec. 14, 2015**

(30) **Foreign Application Priority Data**

Jun. 30, 2015 (KR) 30-2015-0032946

(51) **LOC (11) Cl.** **14-02**

(52) **U.S. Cl.**
USPC **D14/345**

(58) **Field of Classification Search**
USPC D14/315, 341-345, 320, 392
CPC G06F 1/16; G06F 3/00; G06F 3/14; H04B
1/38; H05K 7/00
See application file for complete search history.

(56) **References Cited**

U.S. PATENT DOCUMENTS

D639,296 S *	6/2011	Tseng	D14/345
D678,272 S *	3/2013	Groene	D14/341
D683,731 S *	6/2013	Chiu	D14/345
D688,237 S *	8/2013	Paulhac	D14/315
D690,302 S *	9/2013	Park	D14/392
D696,254 S *	12/2013	Groene	D14/341
D709,490 S *	7/2014	Lee	D14/315
8,913,376 B2 *	12/2014	Wu	G06F 1/1626 248/917
D753,648 S *	4/2016	Shyu	D14/315

D779,485 S *	2/2017	Akana	D14/345
D780,174 S *	2/2017	Park	D14/341
D789,355 S *	6/2017	Cebe	D14/315
D789,369 S *	6/2017	Kim	D14/391
2012/0140396 A1 *	6/2012	Zeliff	G06F 1/1628 361/679.09
2012/0293953 A1 *	11/2012	Wu	F16M 11/10 361/679.56
2013/0271373 A1 *	10/2013	Milhe	G06F 1/1671 345/168
2014/0071654 A1 *	3/2014	Chien	H01H 13/704 362/23.03

(Continued)

FOREIGN PATENT DOCUMENTS

EM	001414205-0015	6/2014
EM	001427058-0003	1/2015
KR	30-0759346	9/2014

Primary Examiner — Barbara Fox

(74) *Attorney, Agent, or Firm* — McAndrews Held & Malloy, Ltd.

(57) **CLAIM**

The ornamental design for an electronic device, as shown and described.

DESCRIPTION

FIG. 1 is a front perspective view of an electronic device showing our new design;
FIG. 2 is a front elevation view thereof;
FIG. 3 is a rear elevation view thereof;
FIG. 4 is a left-side elevation view thereof;
FIG. 5 is a right-side elevation view thereof;
FIG. 6 is a top plan view thereof;
FIG. 7 is a bottom plan view thereof; and,
FIG. 8 is a front perspective view thereof, in an alternate position.
The dashed broken lines depict portions of the electronic device that form no part of the claimed design.

1 Claim, 8 Drawing Sheets

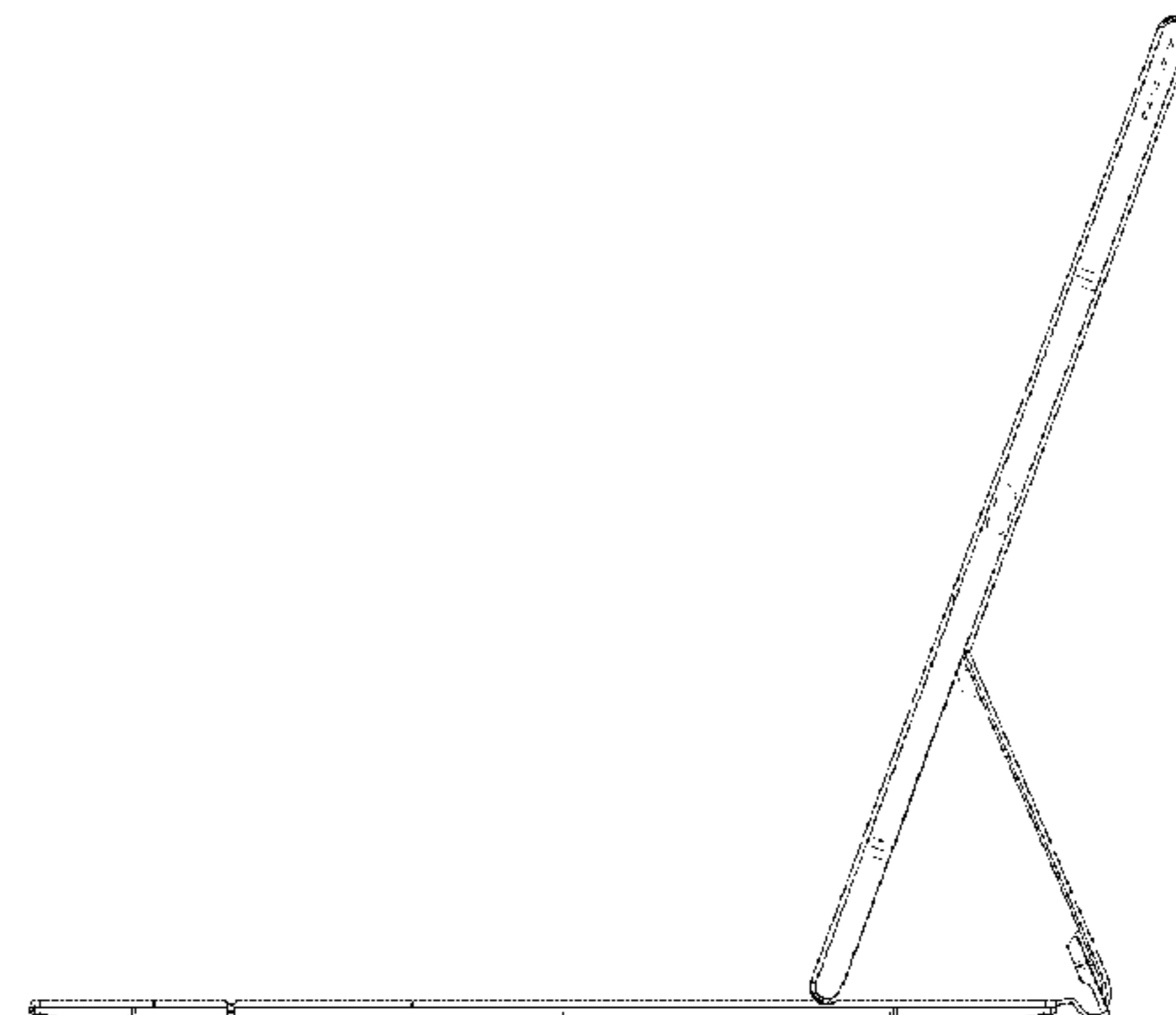
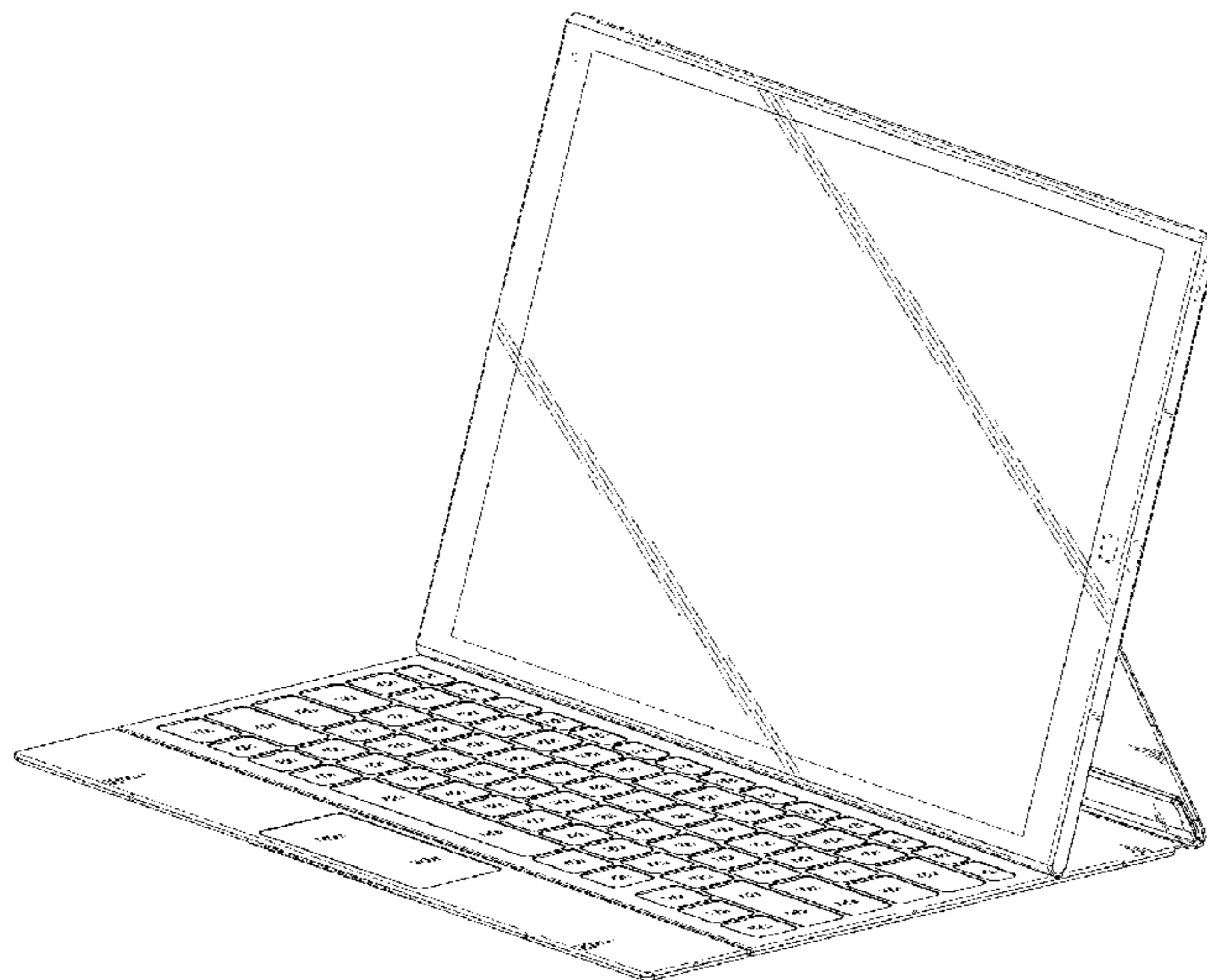

(56)

References Cited

U.S. PATENT DOCUMENTS

2014/0262715 A1* 9/2014 Lee H01H 13/85
200/5 A

* cited by examiner

FIG. 1

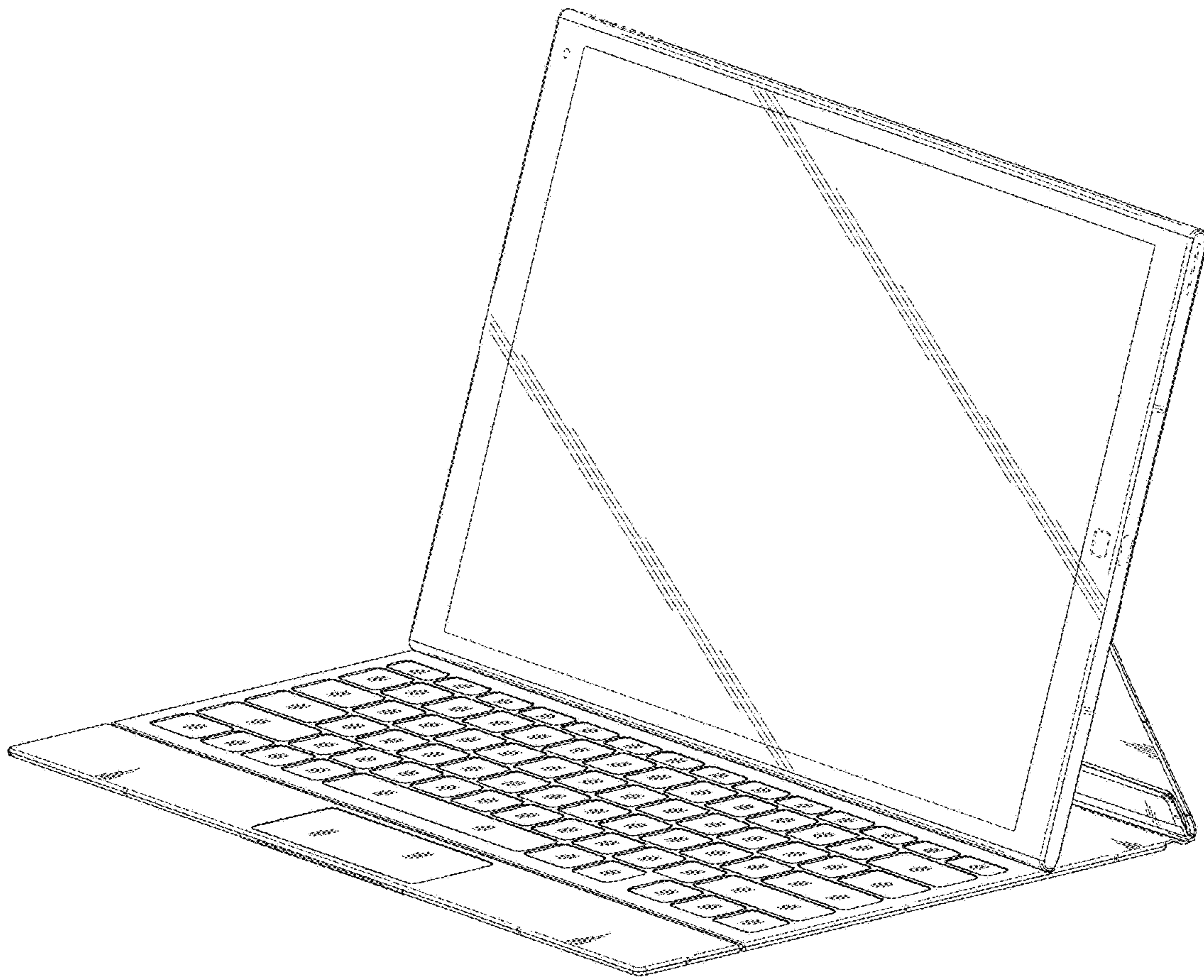

FIG. 2

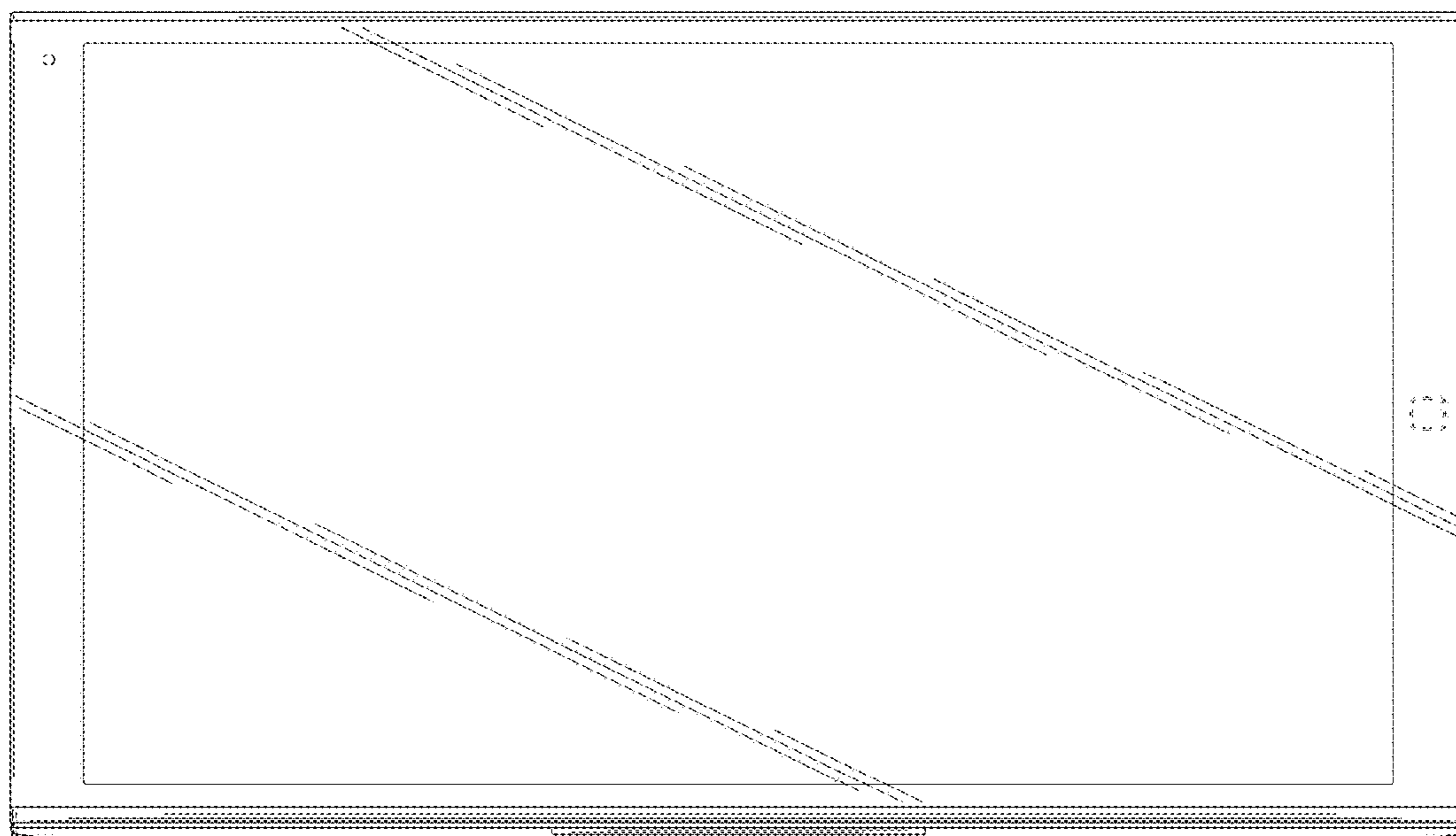

FIG. 3

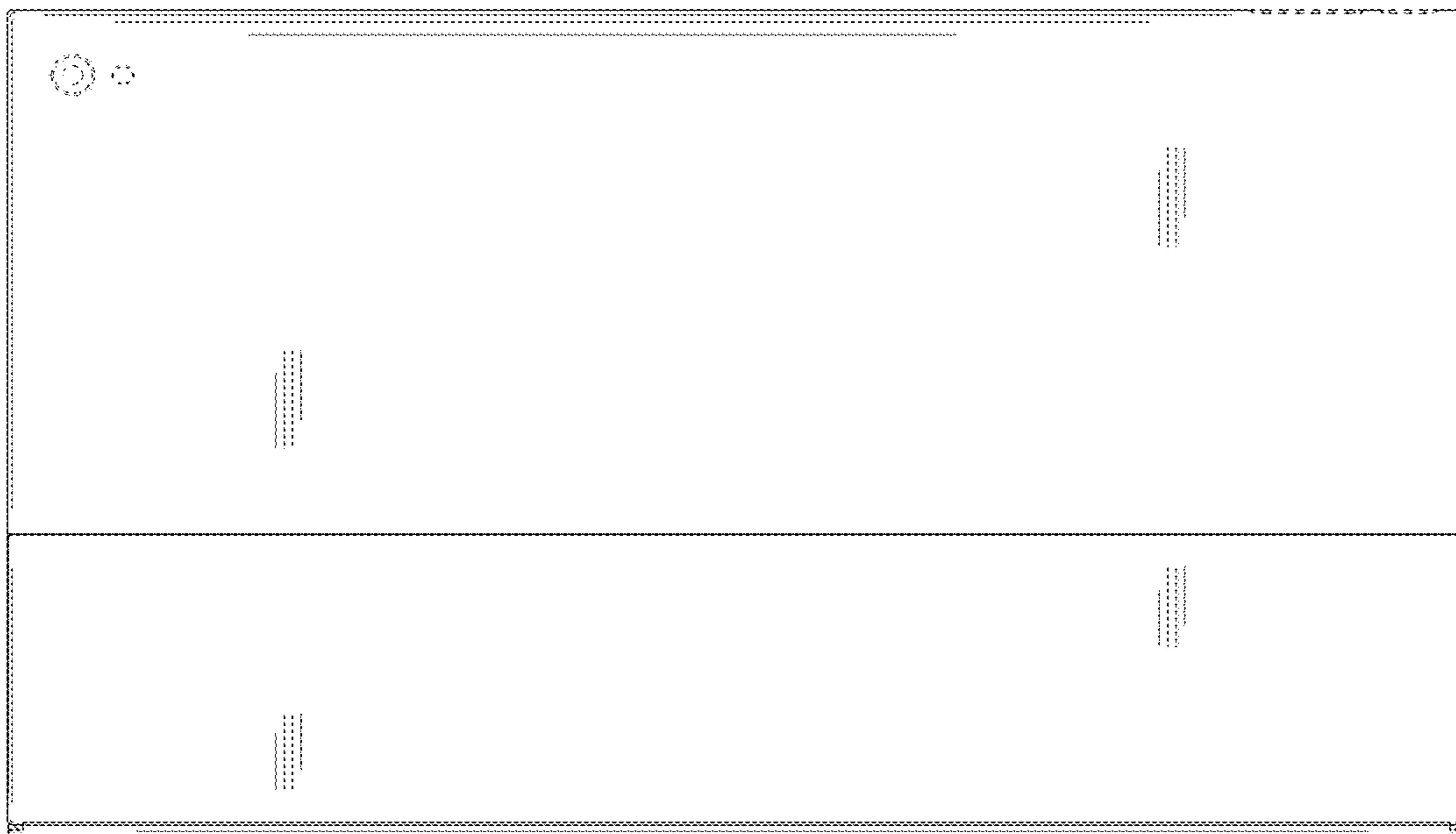

FIG. 4

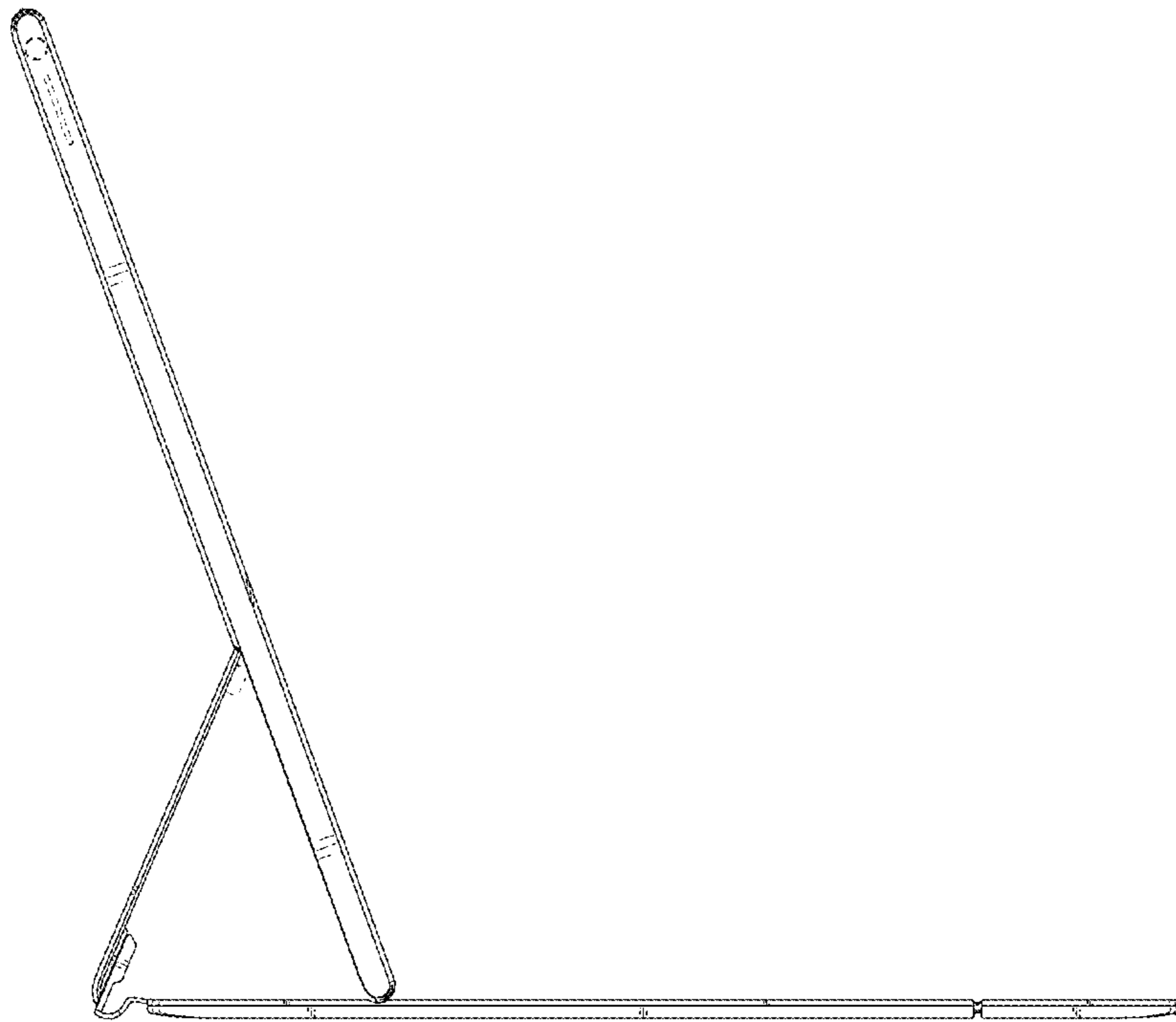

FIG. 5

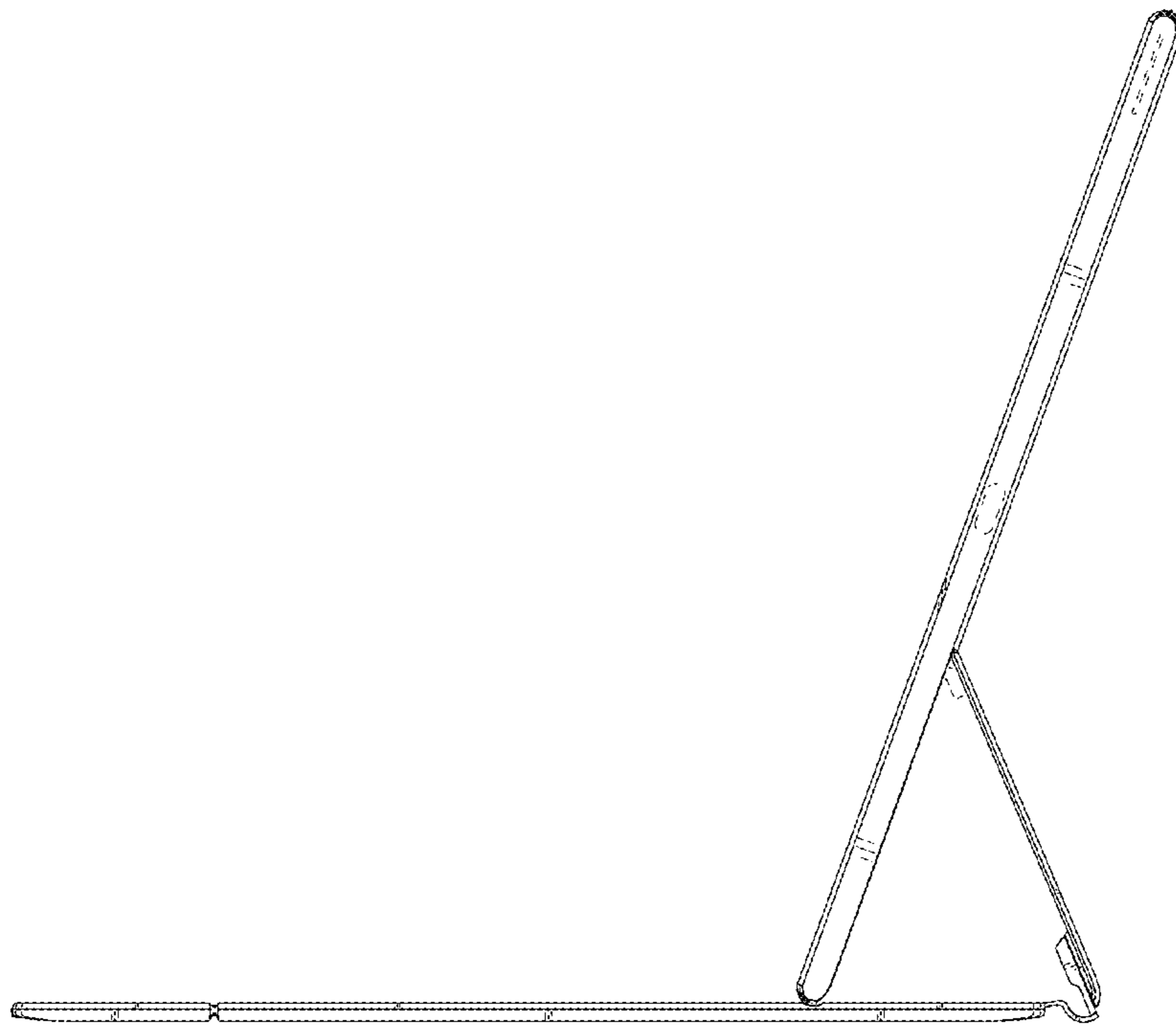

FIG. 6

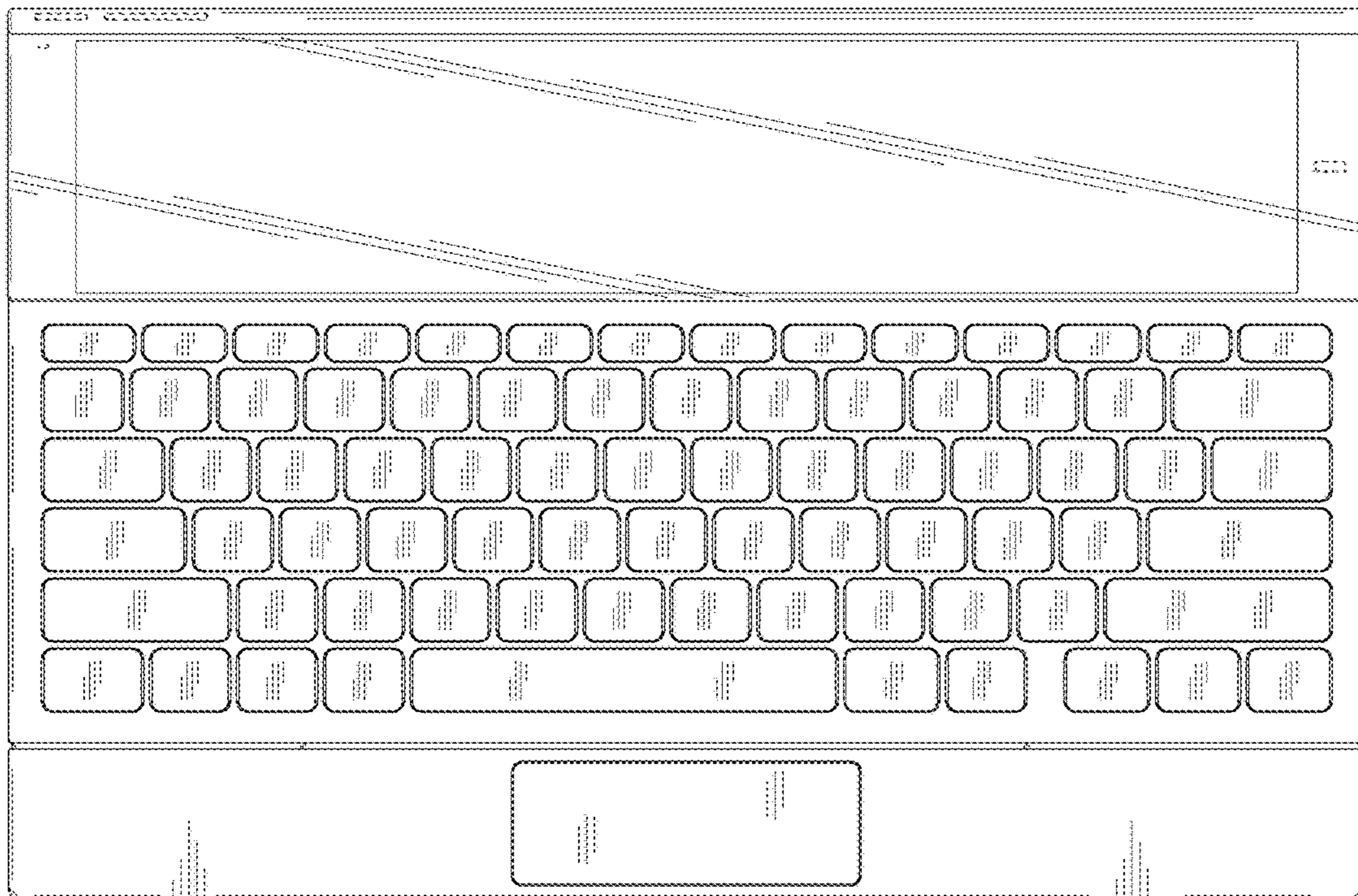

FIG. 7

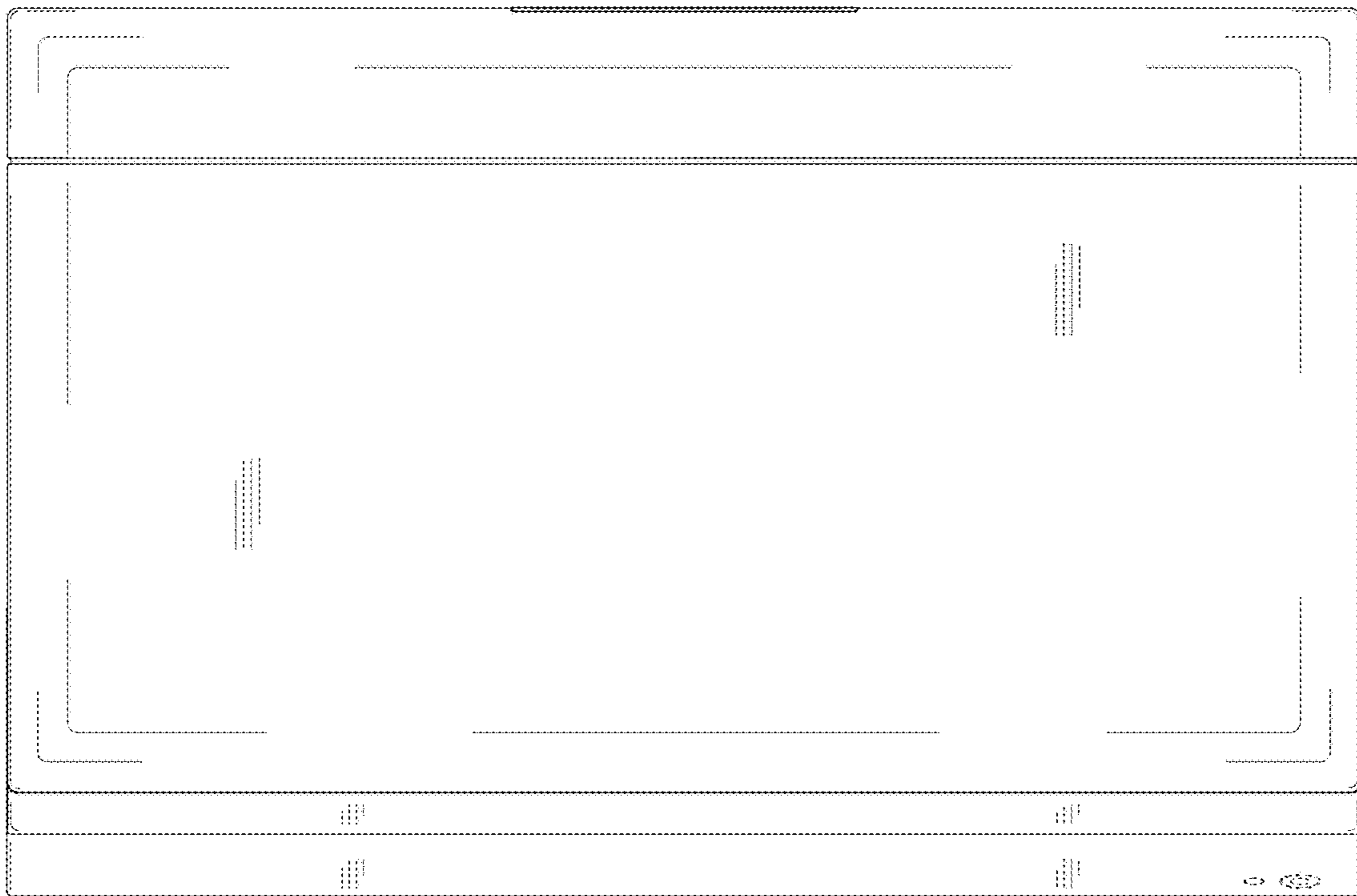

FIG. 8

