



US00D811287S

(12) **United States Design Patent** (10) **Patent No.:** **US D811,287 S**  
**Bucher et al.** (45) **Date of Patent:** **\*\* Feb. 27, 2018**

(54) **VEHICLE FRONT LOWER BUMPER COVER**

(71) Applicant: **Ford Global Technologies, LLC,**  
Dearborn, MI (US)

(72) Inventors: **George Bucher,** Dearborn, MI (US);  
**Dean Carbis,** Bloomfield Hills, MI  
(US); **Shawn Yu,** Canton, MI (US)

(73) Assignee: **Ford Global Technologies, LLC,**  
Dearborn, MI (US)

(\*\*) Term: **15 Years**

(21) Appl. No.: **29/583,152**

(22) Filed: **Nov. 2, 2016**

(51) **LOC (11) Cl.** ..... **12-16**

(52) **U.S. Cl.**  
USPC ..... **D12/169; D12/167**

(58) **Field of Classification Search**  
USPC ..... D12/86, 90, 91, 92, 163, 164, 167, 169,  
D12/171, 196, 216  
CPC ..... B60R 19/02; B60R 19/18; B60R 19/24;  
B60R 19/56; B60R 2019/007  
See application file for complete search history.

(56) **References Cited**

**U.S. PATENT DOCUMENTS**

D291,680 S *	9/1987	Everts .....	D12/170
6,511,109 B1 *	1/2003	Schultz .....	B60R 19/18 293/102
D542,196 S *	5/2007	Levy .....	D12/169
D560,145 S *	1/2008	Tant .....	D12/169
D590,753 S *	4/2009	Williams .....	D12/169
D600,606 S *	9/2009	Lamm .....	D12/169
D601,063 S *	9/2009	Lamm .....	D12/169
D603,765 S *	11/2009	Youn .....	D12/169
D607,384 S *	1/2010	Krauss .....	D12/181
D644,574 S *	9/2011	Vardis .....	D12/169
D646,607 S *	10/2011	Verhee .....	D12/169

8,210,600 B1 *	7/2012	Verhee .....	B62D 35/005 296/180.1
D664,903 S *	8/2012	Platto .....	D12/169
D699,168 S *	2/2014	Osborne .....	D12/169
D710,767 S *	8/2014	Heilaneh .....	D12/169
D744,922 S *	12/2015	Jamieson .....	D12/196
D751,007 S *	3/2016	Curic .....	D12/169
D753,036 S *	4/2016	Curic .....	D12/169
9,365,249 B2 *	6/2016	Ishikawa .....	B62D 35/02
D762,147 S *	7/2016	Messale .....	D12/169
D766,143 S *	9/2016	Maeda .....	D12/169
D772,770 S *	11/2016	Yoshimine .....	D12/190
D775,026 S *	12/2016	Platto .....	D12/181
D787,386 S *	5/2017	Chang .....	D12/169

(Continued)

**OTHER PUBLICATIONS**

Brad Anderson <http://www.carscoops.com/2016/02/ford-ecosport-tipped-to-reach-us-shores.html> Ford EcoSport Tipped to Reach US Shores, dated Feb. 13, 2016.

(Continued)

*Primary Examiner* — Darlington Ly

(74) *Attorney, Agent, or Firm* — James Dottavio

(57) **CLAIM**

The ornamental design for a vehicle front lower bumper cover, as shown and described.

**DESCRIPTION**

FIG. 1 is a top and front perspective view of a vehicle front lower bumper cover showing our new design;  
FIG. 2 is a bottom and front perspective view thereof;  
FIG. 3 is a top and rear perspective view thereof;  
FIG. 4 is a front elevational view thereof;  
FIG. 5 is a rear elevational view thereof;  
FIG. 6 is a left side elevational view thereof;  
FIG. 7 is a right side elevational view thereof;  
FIG. 8 is a top plan view thereof; and,  
FIG. 9 is a bottom plan view thereof.

**1 Claim, 9 Drawing Sheets**

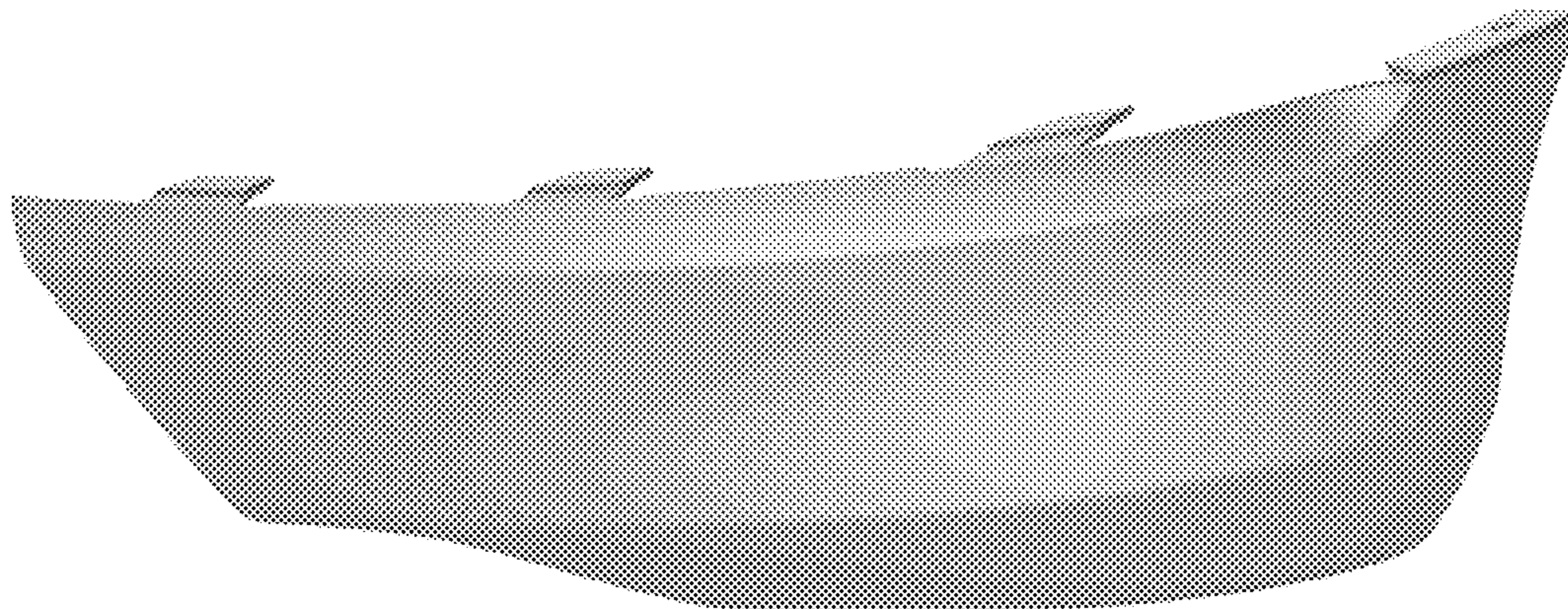

(56)

**References Cited**

U.S. PATENT DOCUMENTS

D788,658 S \* 6/2017 Chang ..... D12/169  
9,714,059 B2 \* 7/2017 Fahland ..... B62D 35/005  
D793,924 S \* 8/2017 Sagawa ..... D12/169  
9,738,328 B2 \* 8/2017 Fahland ..... B62D 35/005  
2009/0115221 A1 \* 5/2009 Shinedling ..... B62D 35/005  
296/180.5  
2012/0292943 A1 \* 11/2012 Danev ..... B62D 35/005  
296/180.1  
2015/0210324 A1 \* 7/2015 Kojima ..... B62D 35/005  
296/180.1  
2015/0232138 A1 \* 8/2015 Parry-Williams ..... B62D 35/02  
296/180.5

OTHER PUBLICATIONS

Unknown <http://www.2017suv.net/2018-ford-ecosport-release-2017-in-usa/> 2018 Ford EcoSport Release 2017 in USA dated Feb. 20, 2016.

Brandon Turkus <http://www.autoblog.com/2016/04/25/ford-ecosport-spy-shots-us/> Ford EcoSport spotted in US with Escape-inspired face dated Apr. 25, 2016.

Unknown <http://www.oncars.in/car-news/spotod-2017-ford-ecosport-reveals-front-facia-india-launch-by-next-year/10372>

Spotted: 2017 Ford EcoSport reveals front facia; India launch by next year dated Apr. 28, 2016.

\* cited by examiner

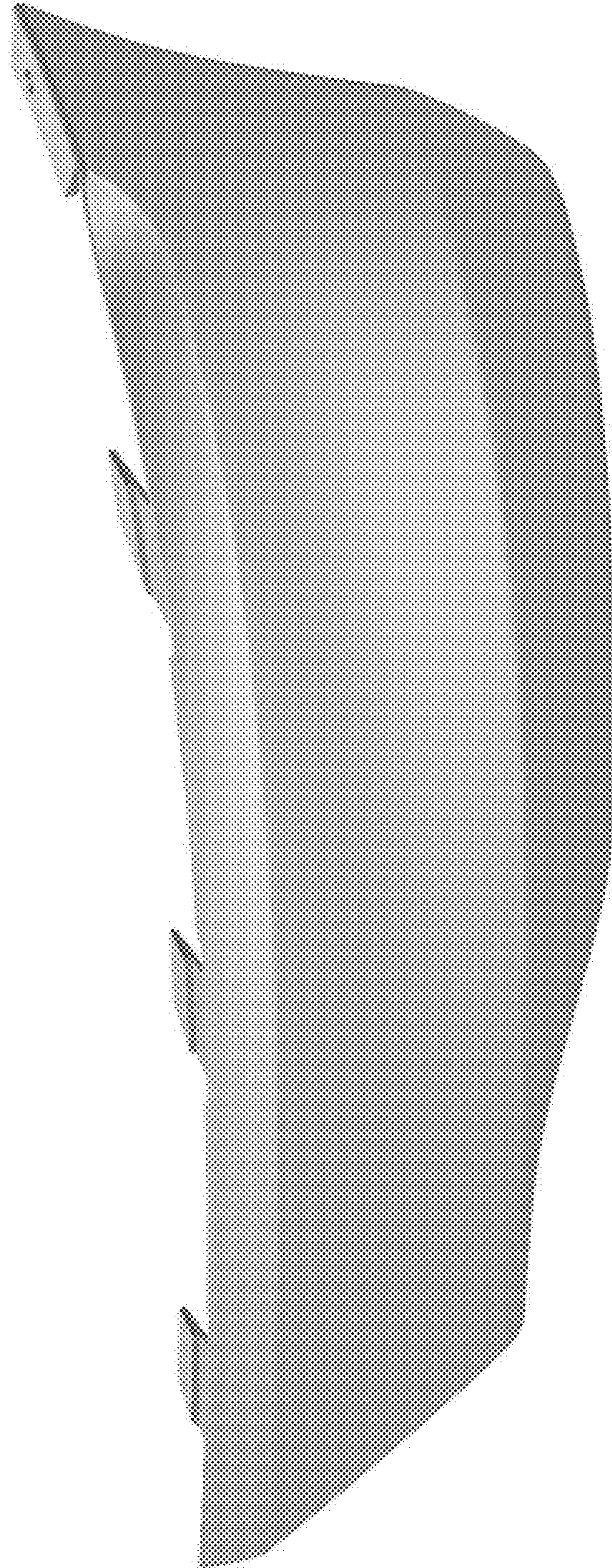

Figure 1

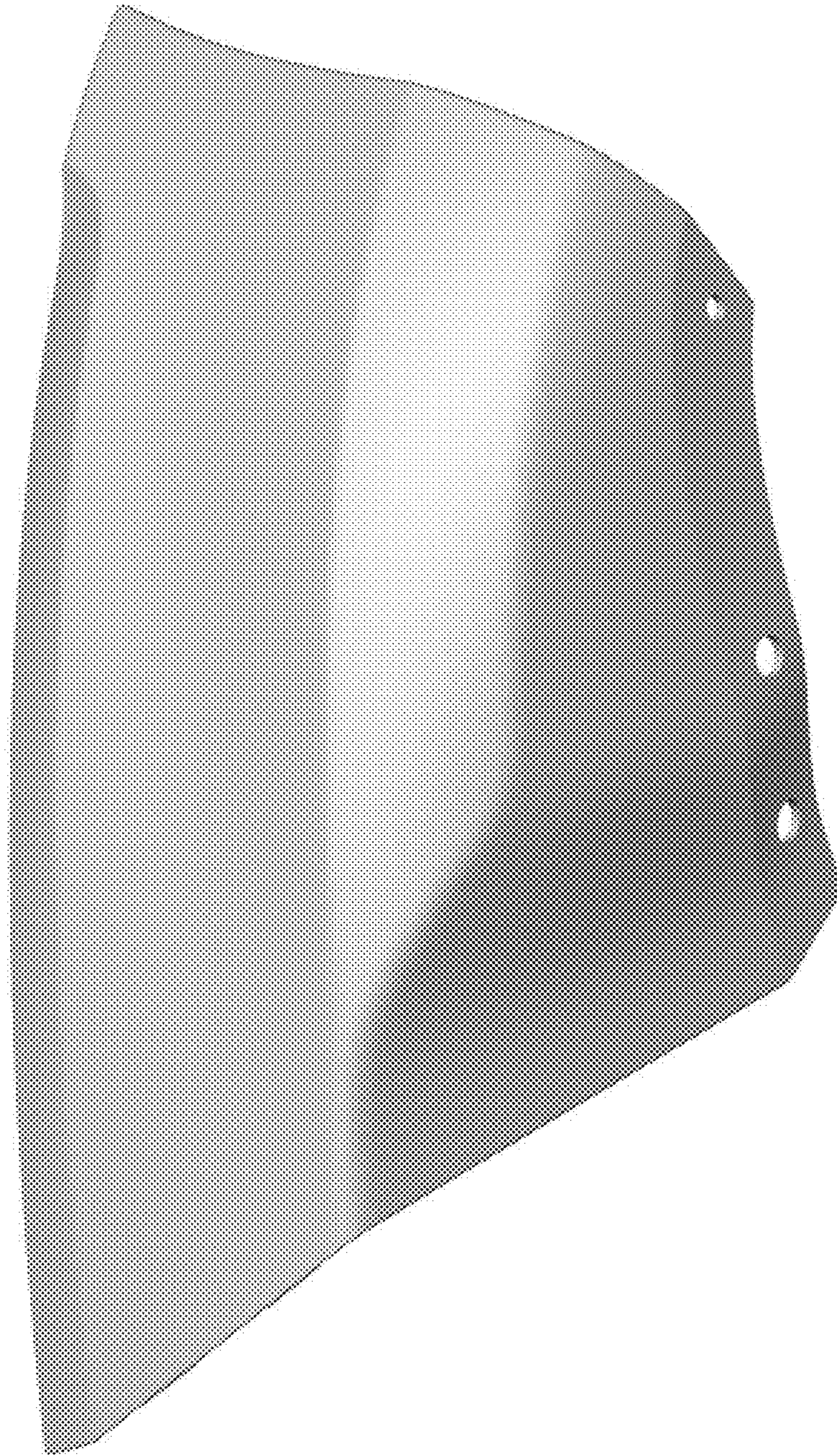

Figure 2

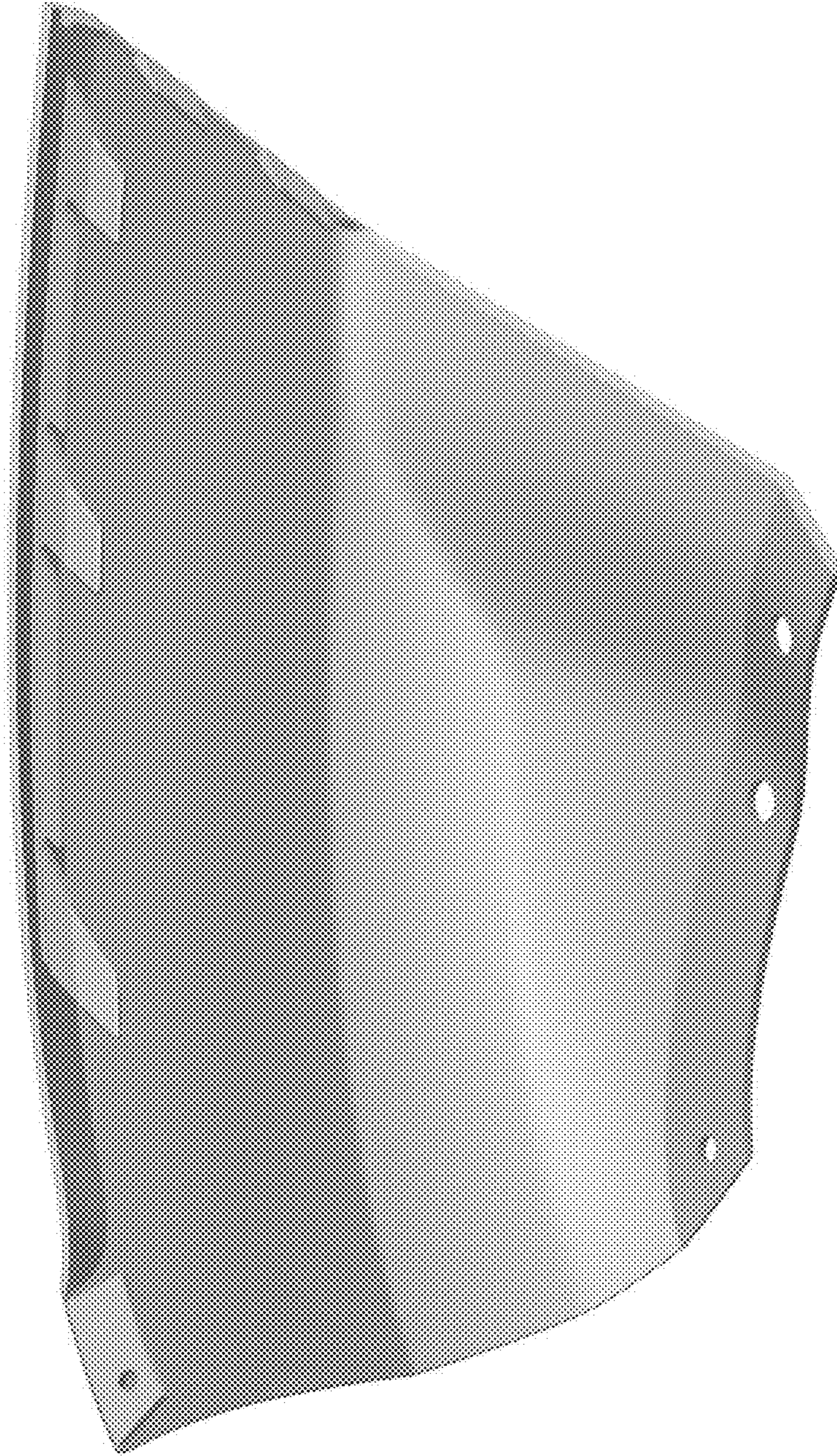

Figure 3

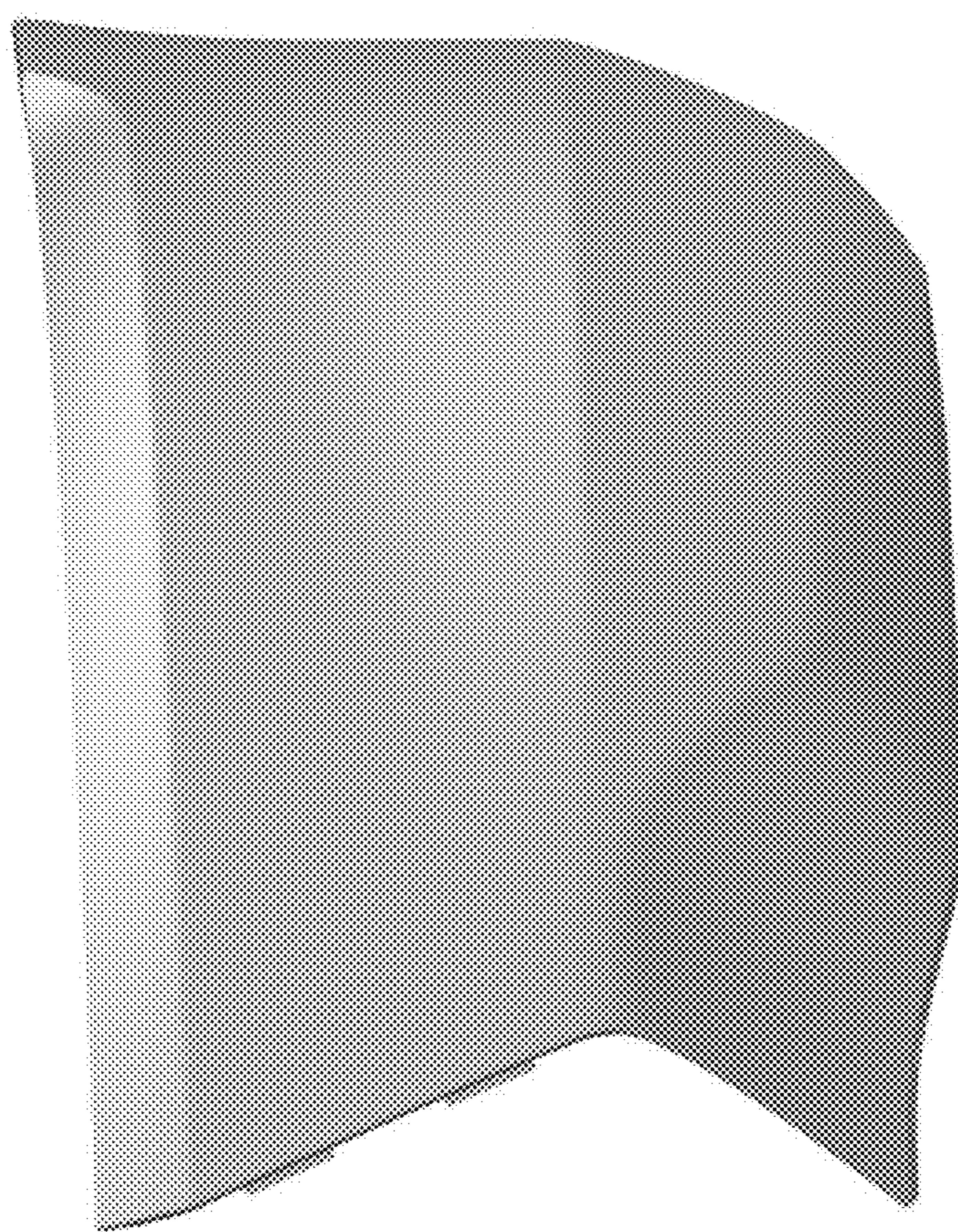

Figure 4

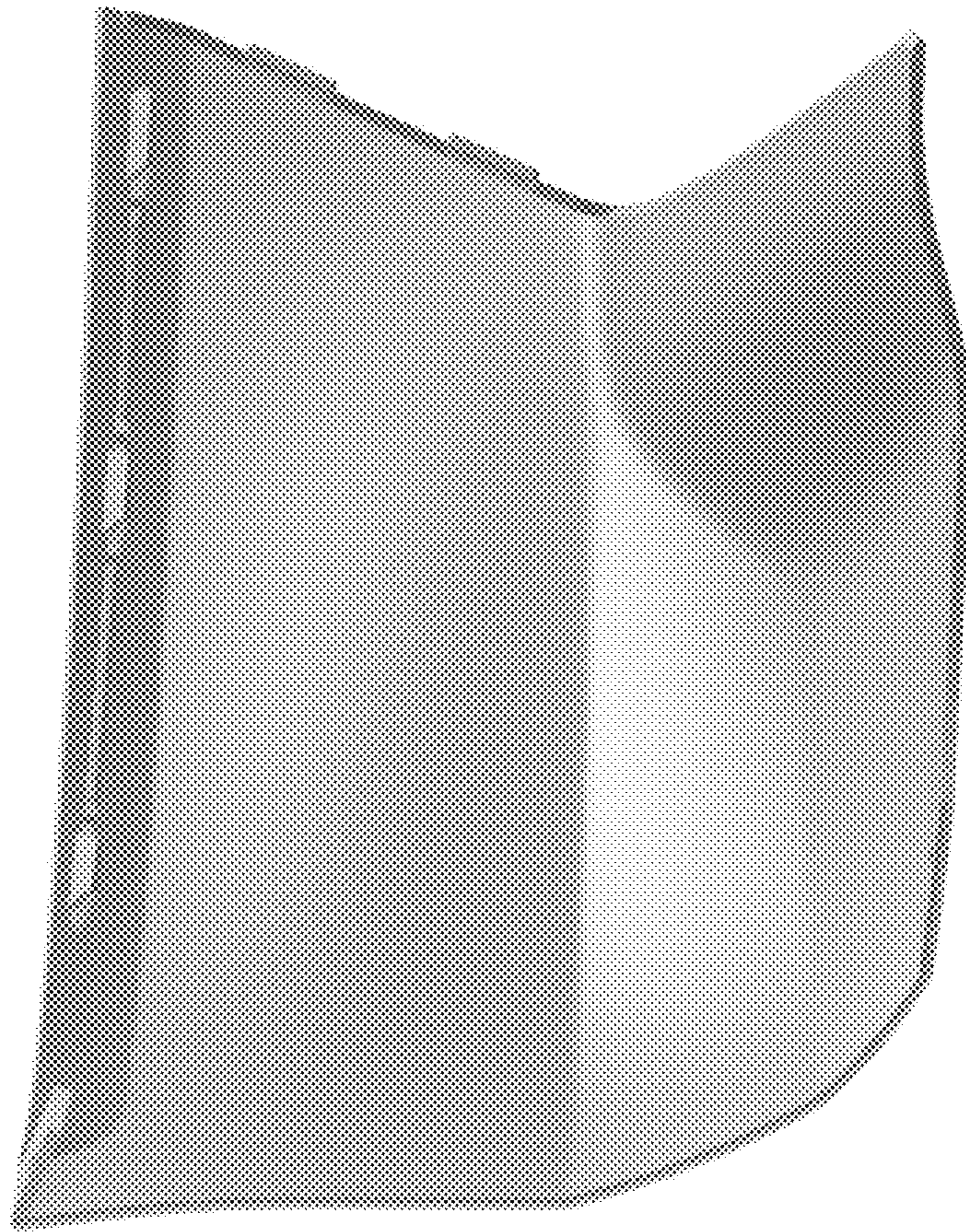

Figure 5

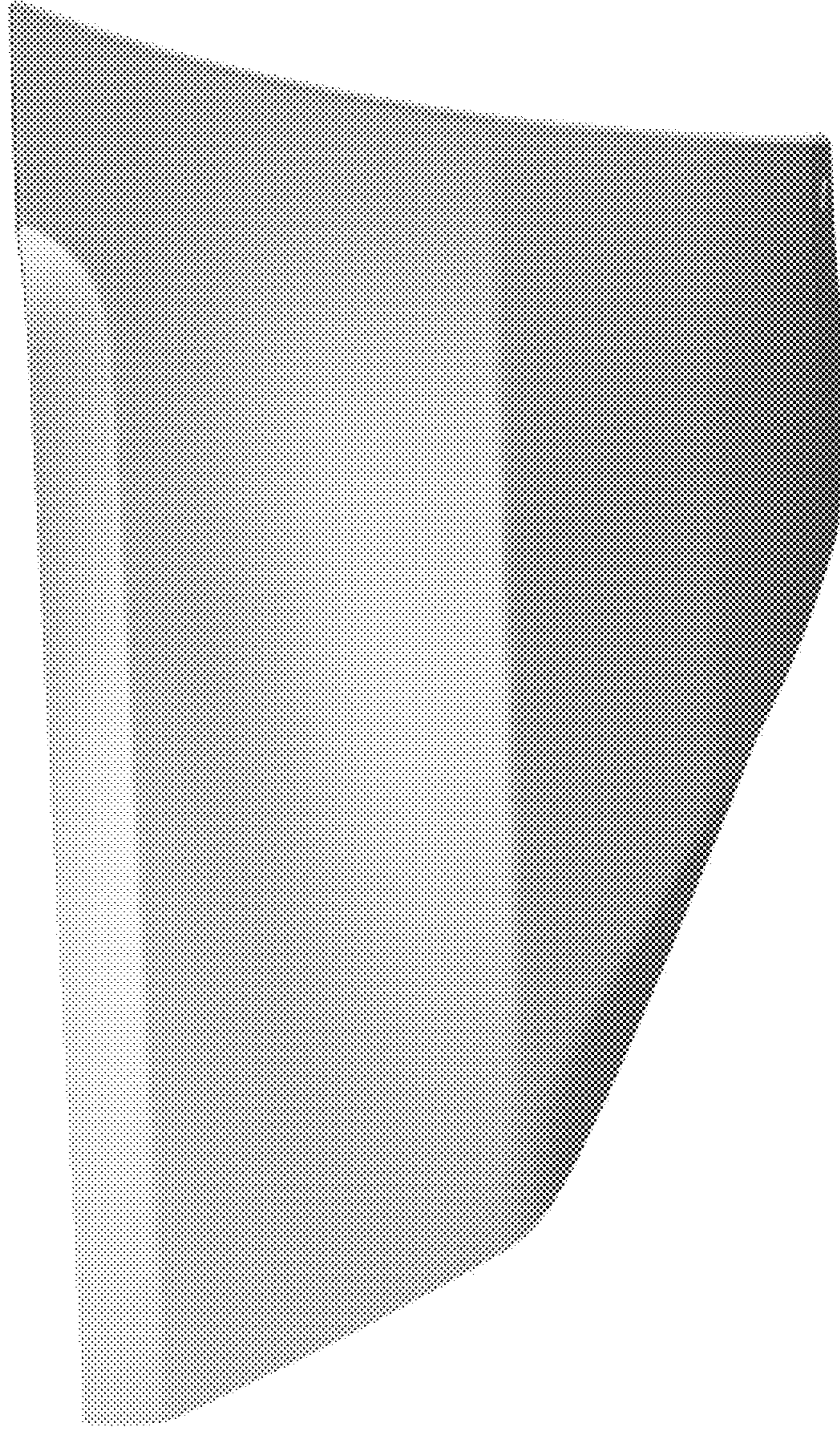

Figure 6



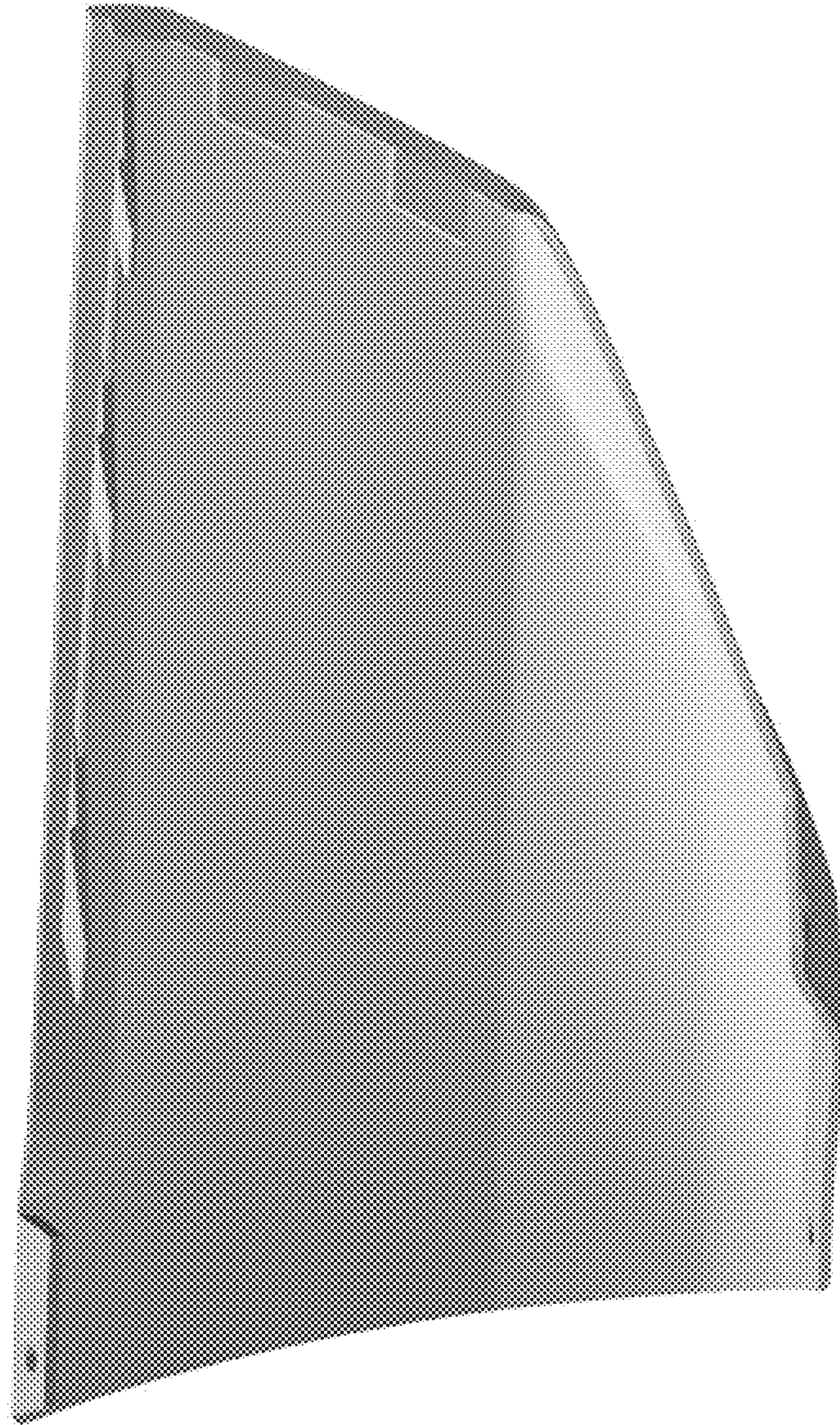

Figure 7

Figure 8

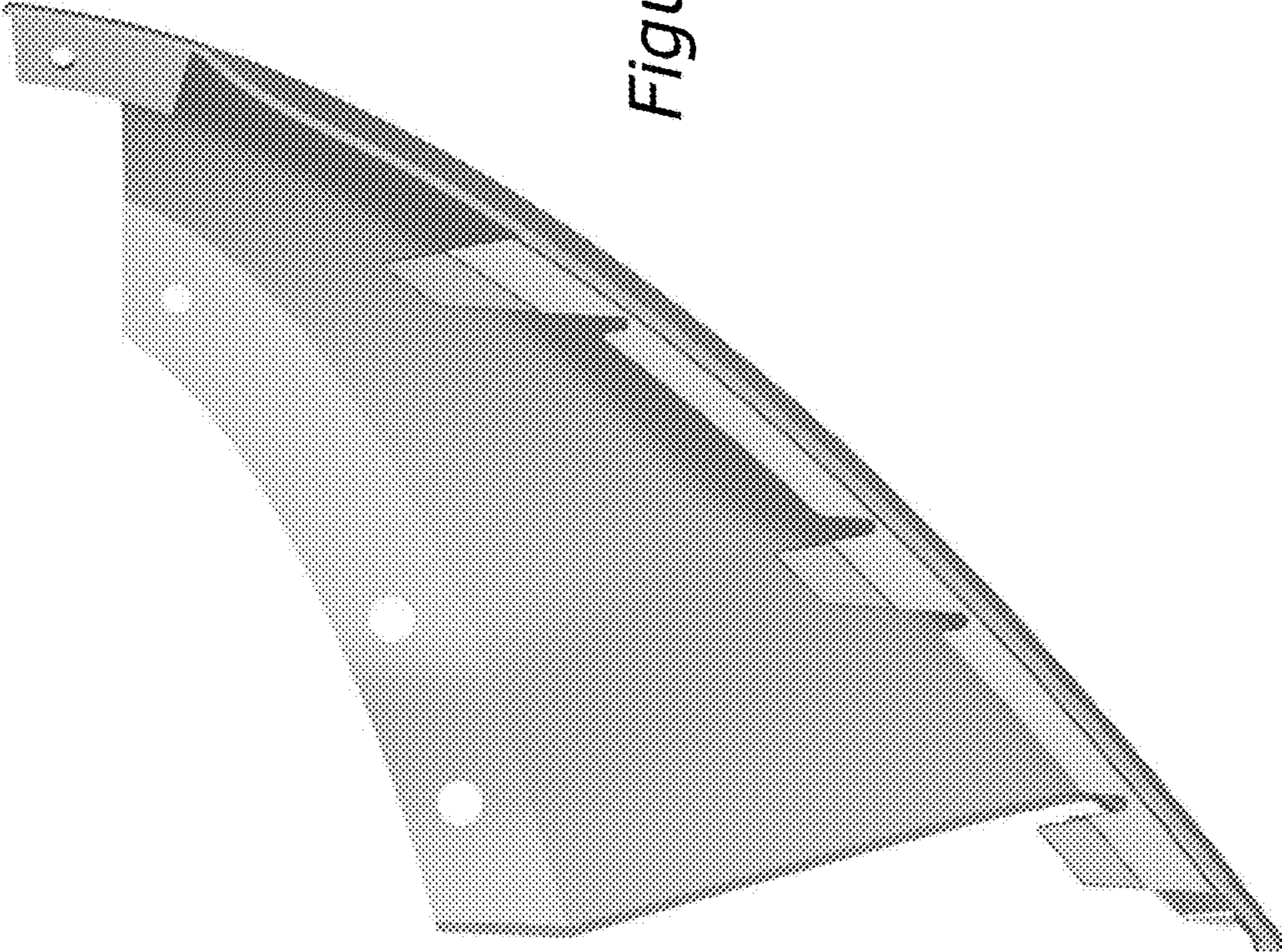

Figure 9

