



US00D811258S

(12) **United States Design Patent** (10) **Patent No.:** **US D811,258 S**  
**Buonamassa Stigliani** (45) **Date of Patent:** **\*\* Feb. 27, 2018**

(54) **WATCH**

G04B 17/00; G04B 17/005; G04B 17/285; G04B 37/18; G04B 37/081; G04B 37/082

(71) Applicant: **Bulgari Horlogerie S.A.**, Neuchatel (CH)

See application file for complete search history.

(72) Inventor: **Fabrizio Buonamassa Stigliani**, Neuchatel (CH)

(56) **References Cited**

(73) Assignee: **BULGARI HORLOGERIE S.A.**, Neuchatel (CH)

U.S. PATENT DOCUMENTS

(\*\*) Term: **15 Years**

(21) Appl. No.: **29/539,793**

247,701	A	*	9/1881	Smith	.....	A44C 5/12
						63/8
D28,720	S	*	5/1898	La Pierre	.....	D11/5
D39,035	S	*	1/1908	Mitchell	.....	D11/5
D39,037	S	*	1/1908	Mitchell	.....	D11/5
D57,991	S	*	5/1921	Palliser	.....	D11/5
D68,195	S	*	9/1925	De Soria	.....	D11/5
D119,192	S	*	2/1940	Welling	.....	D10/32
D119,637	S	*	3/1940	Ornstein	.....	D10/32
D151,186	S	*	9/1948	Philippe	.....	D11/5
D186,818	S	*	12/1959	Gale	.....	D10/32

(Continued)

(22) Filed: **Sep. 17, 2015**

(30) **Foreign Application Priority Data**

Mar. 17, 2015 (WO) ..... DM085879

(51) **LOC (11) Cl.** ..... **11-01**

(52) **U.S. Cl.**  
USPC ..... **D11/5; D10/32**

(58) **Field of Classification Search**  
 USPC ..... D11/1-26, 86, 87, 93, 94; D10/70, 98, D10/32, 38, 30, 31, 33, 34, 35, 36, 37, D10/39; D24/167, 200; D14/344; D3/203.1, 215, 218, 201  
 CPC ..... A44C 5/00; A44C 5/0007; A44C 5/0015; A44C 5/0023; A44C 5/003; A44C 5/0038; A44C 5/0053; A44C 5/0061; A44C 5/0069; A44C 5/0076; A44C 5/0084; A44C 5/0092; A44C 5/02; A44C 5/025; A44C 5/027; A44C 5/08; A61B 5/02405; G04B 19/04; G04B 19/06; G04B 19/065; G04B 19/23; G04B 19/08; G04B 19/10; G04B 19/12; G04B 19/24; G04B 19/26; G04B 19/268; G04B 19/30; G04B 37/084; G04B 37/0008; G04B 37/0058; G04B 37/1486; G04B 17/08;

OTHER PUBLICATIONS

[Online] <http://www.watchonista.com/bulgari/news/baselworld-2016-perpetual-rebirth-serpenti>. Posted online Mar. 20, 2016. Retrieved Oct. 1, 2017.\*

*Primary Examiner* — Melanie Pellegrini  
(74) *Attorney, Agent, or Firm* — Stephen Kenny; Peter Sullivan; Foley Hoag LLP

(57) **CLAIM**

The ornamental design for a watch, as shown and described.

**DESCRIPTION**

FIG. 1 is a front view of a watch showing my new design; FIG. 2 is a back view thereof; FIG. 3 is a perspective view thereof; FIG. 4 is a left side view thereof; FIG. 5 is a right side view thereof; FIG. 6 is a top view thereof; and, FIG. 7 is a bottom view thereof.

**1 Claim, 7 Drawing Sheets**

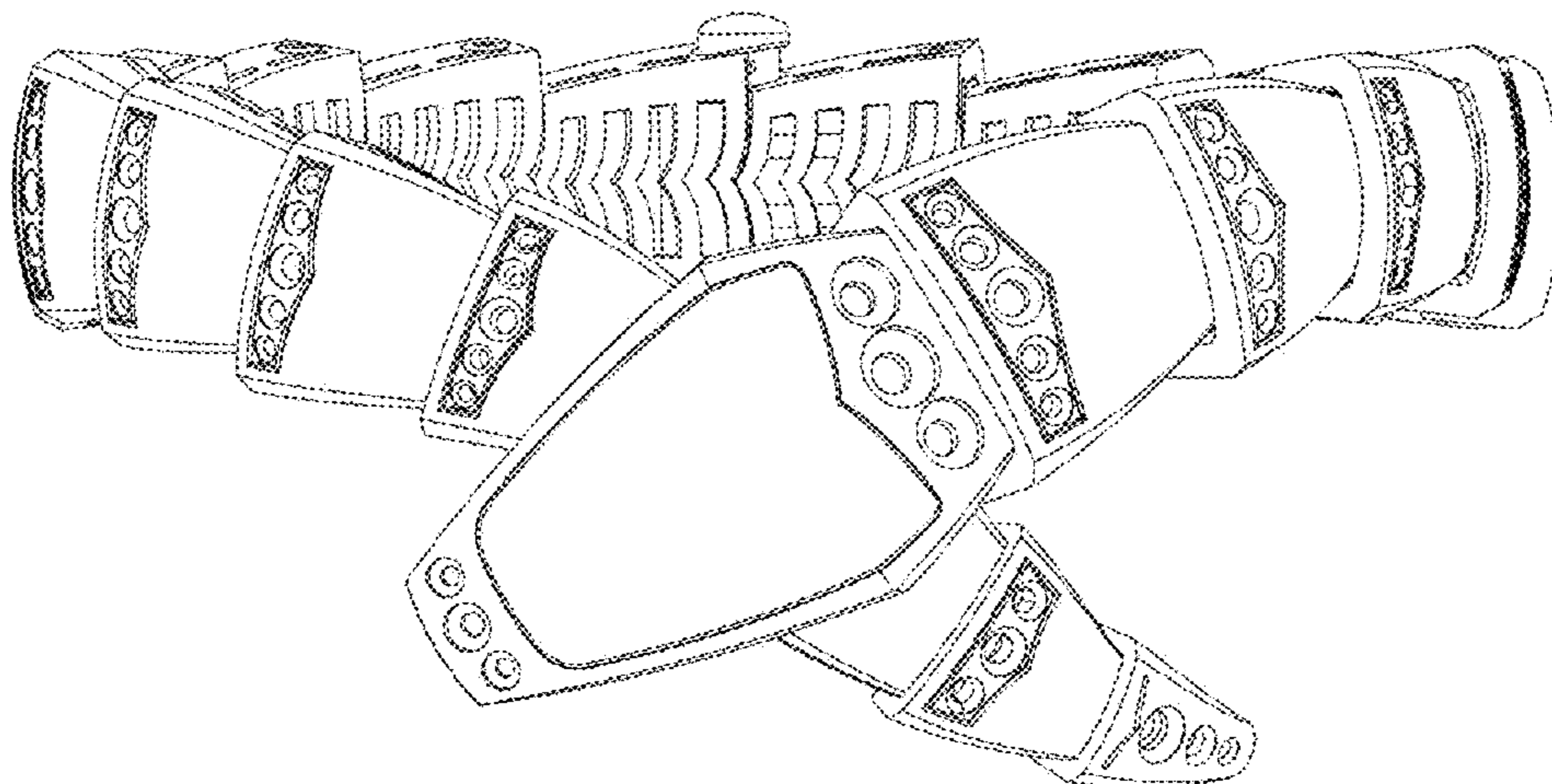

(56)

**References Cited**

U.S. PATENT DOCUMENTS

2,925,706 A \* 2/1960 Morf ..... G04B 3/00  
185/39  
D190,753 S \* 6/1961 Brauchi ..... D11/5  
D237,815 S \* 11/1975 Bulgari et al. .... D10/32  
D237,816 S \* 11/1975 Bulgari et al. .... D11/27  
D338,629 S \* 8/1993 Bulgari ..... D11/29  
D339,082 S \* 9/1993 Bulgari ..... D11/3  
D445,715 S \* 7/2001 Haquet ..... D11/5  
D606,886 S \* 12/2009 Bulgari ..... D10/32  
D606,894 S \* 12/2009 Bulgari ..... D11/5  
D628,092 S \* 11/2010 Bulgari ..... D10/32  
D761,667 S \* 7/2016 Buonamassa Stigliani ... D10/32  
D779,999 S \* 2/2017 Bulgari ..... D11/5  
D780,035 S \* 2/2017 Bulgari ..... D11/42  
D780,036 S \* 2/2017 Silvestri ..... D11/42

\* cited by examiner

FIG. 1

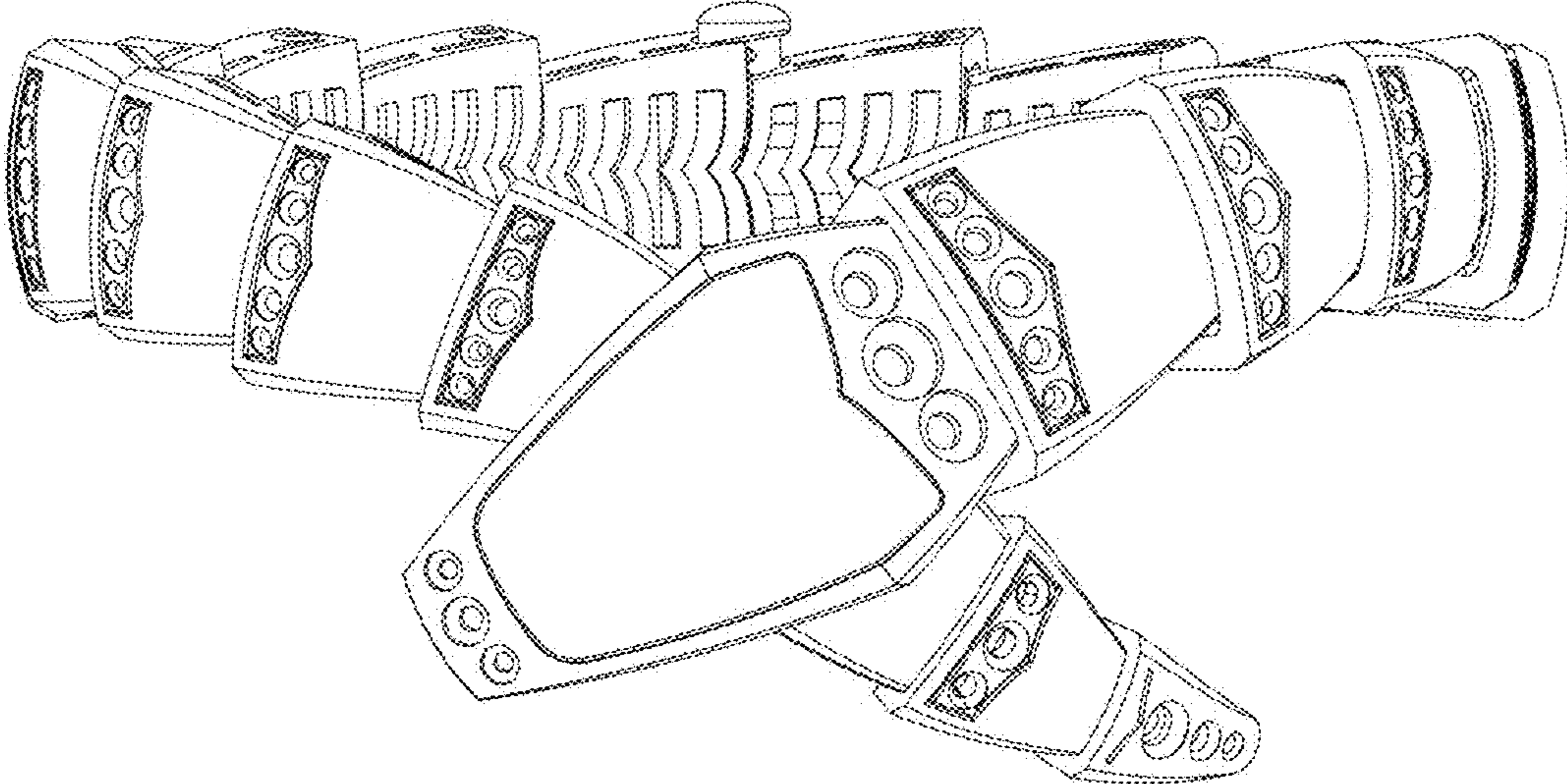



FIG. 2

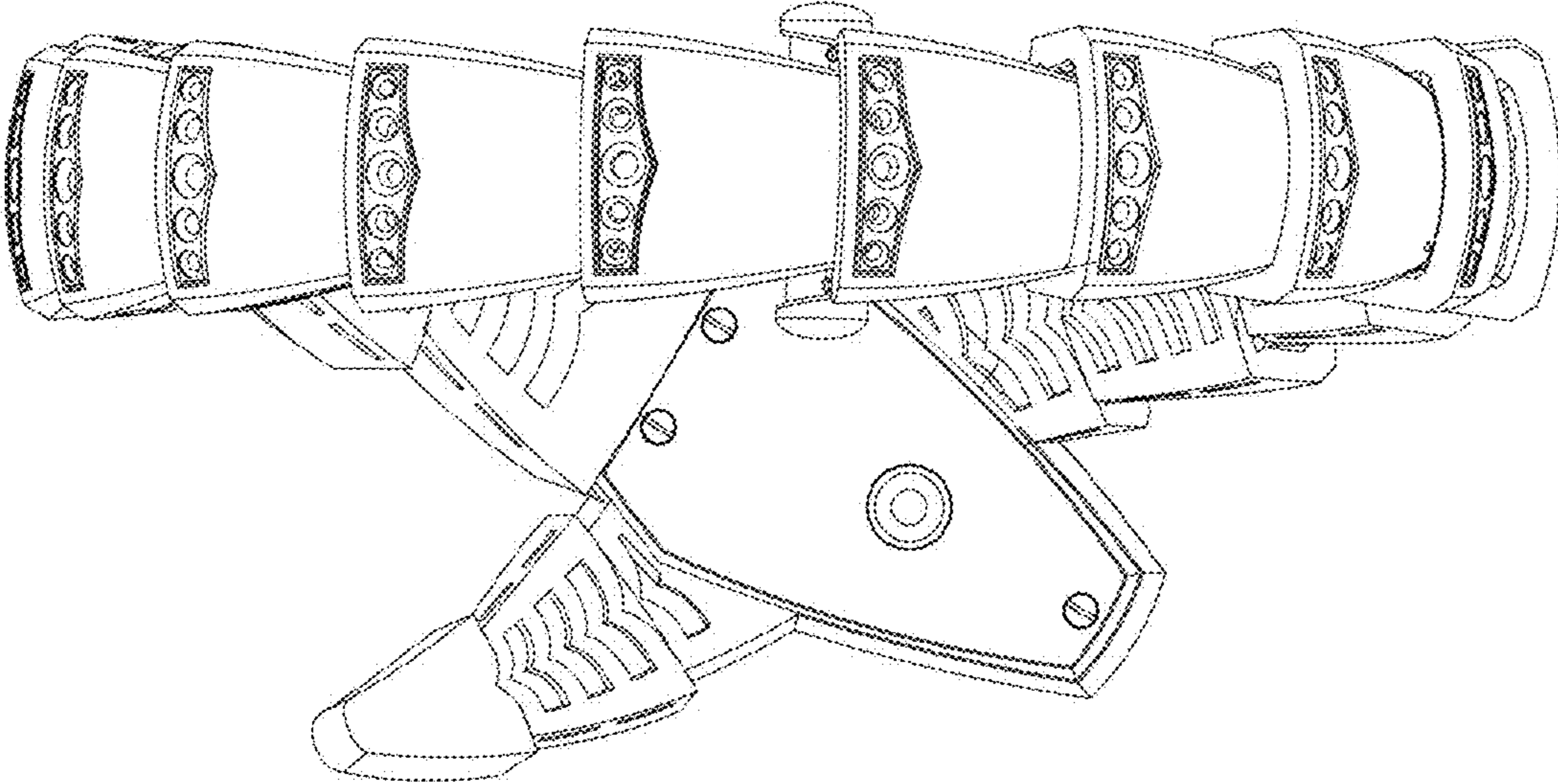

FIG. 3

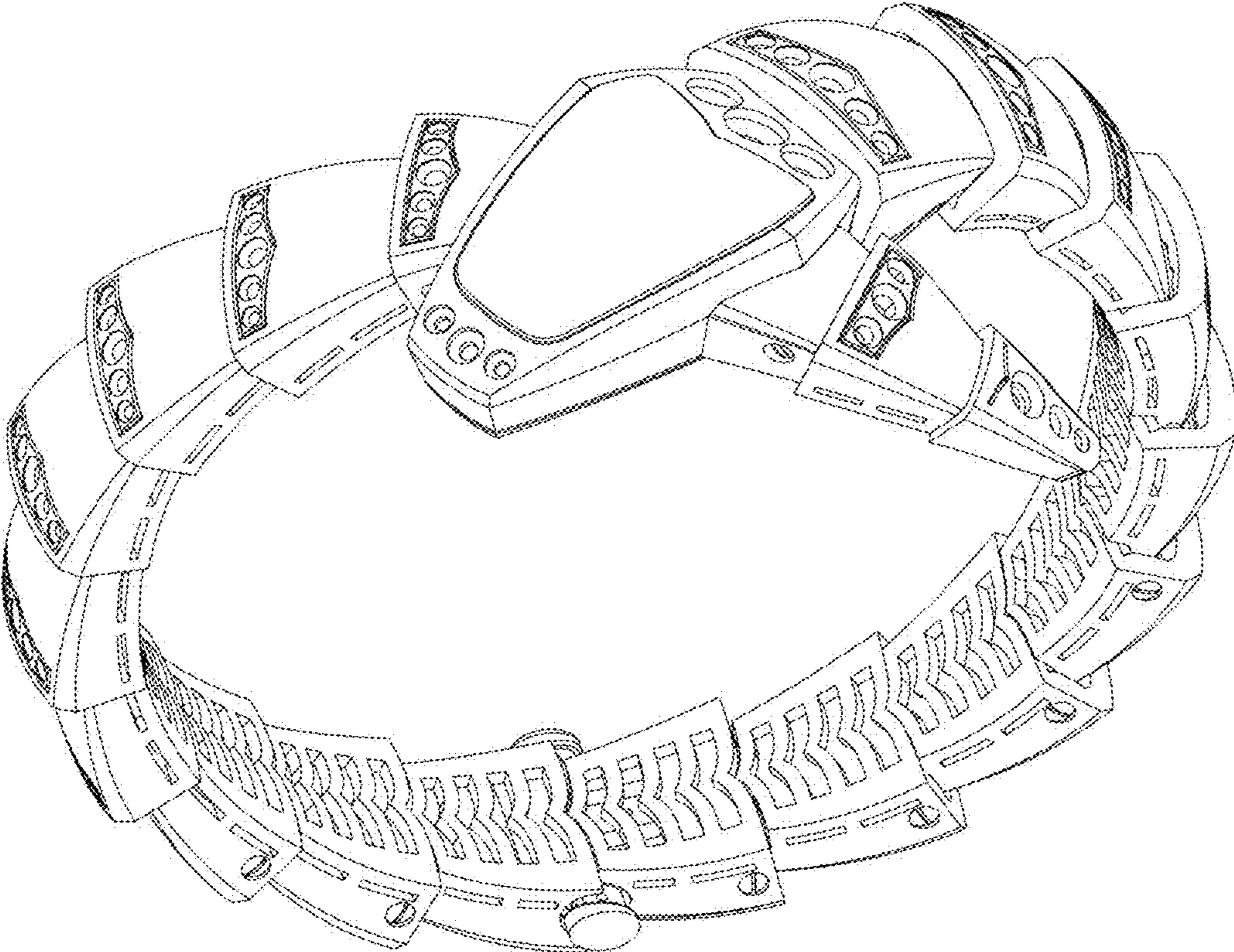

FIG. 4

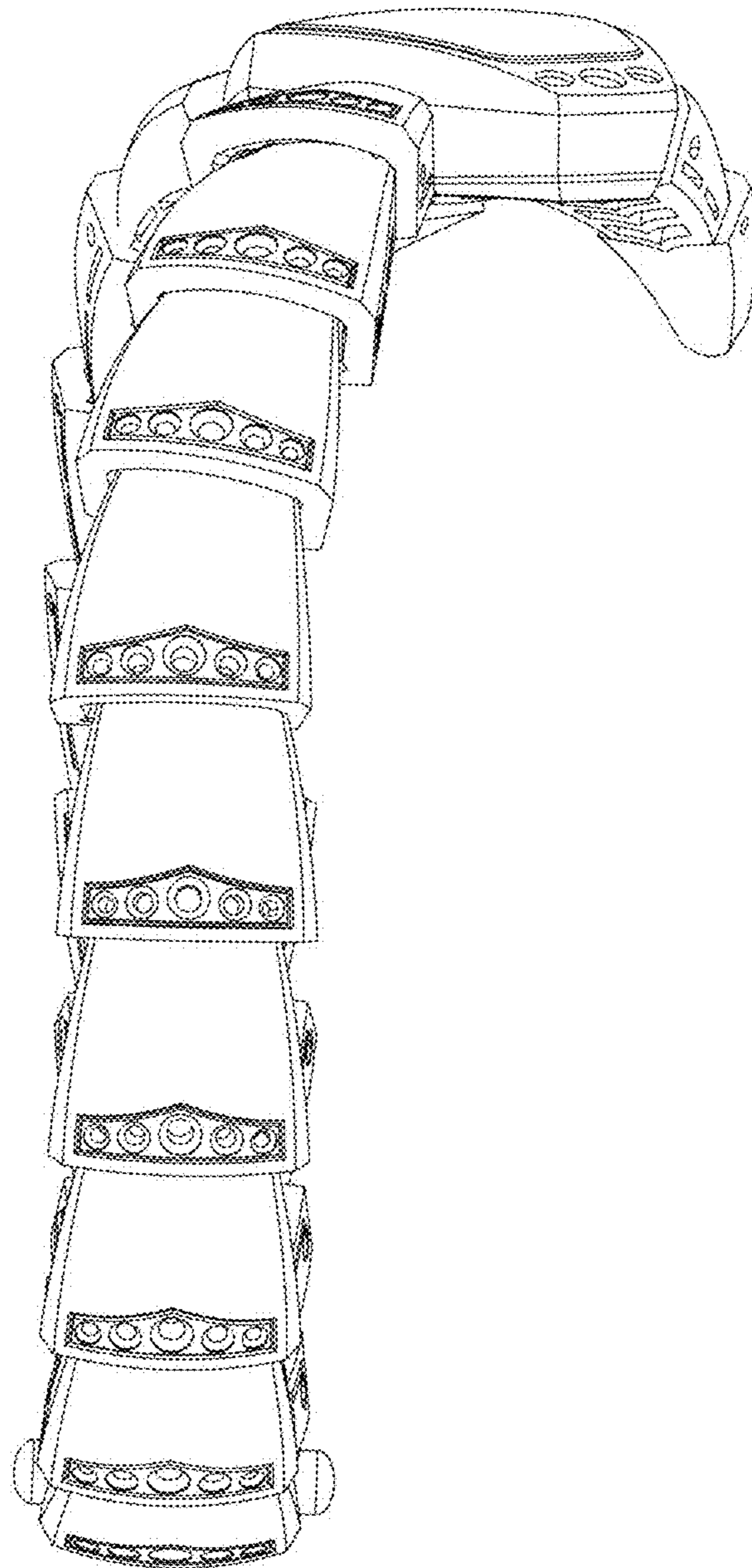

FIG. 5

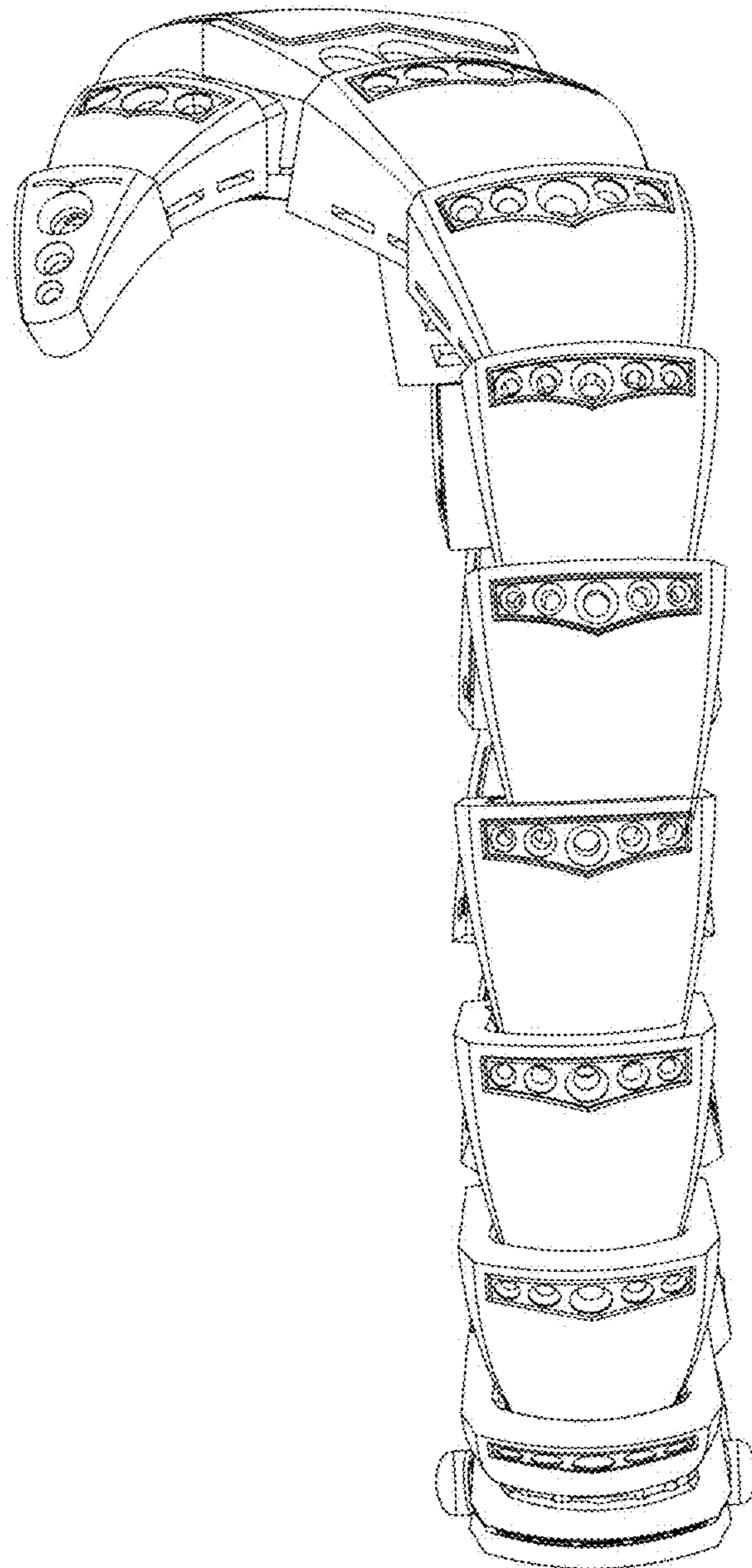



FIG. 6

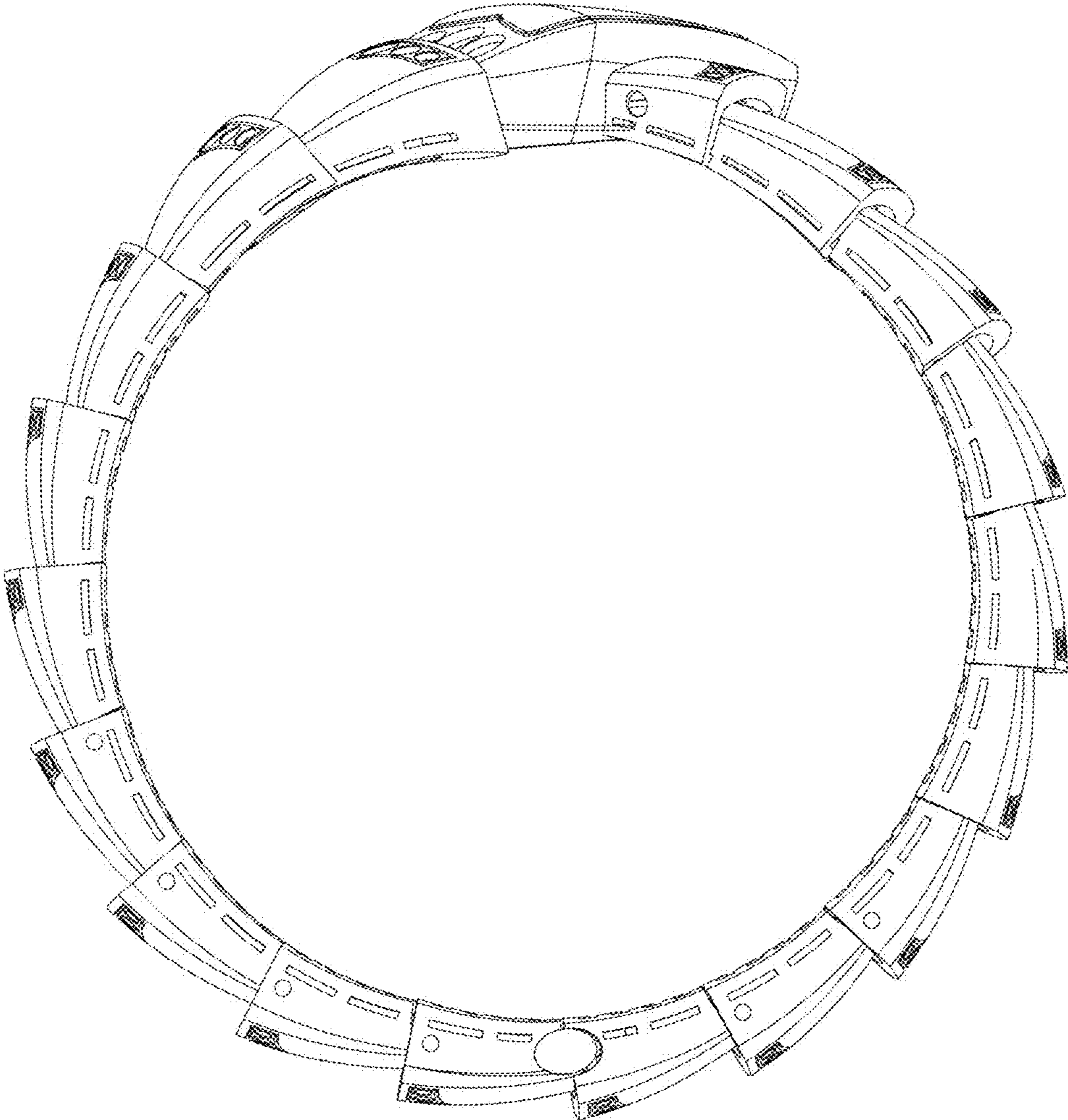



FIG. 7

