



US00D811233S

(12) **United States Design Patent** (10) **Patent No.:** **US D811,233 S**
Snider et al. (45) **Date of Patent:** **** Feb. 27, 2018**

(54) **CONTAINER HAVING SURFACE INDICIA**

D656,837 S * 4/2012 Lanz D9/434
D658,070 S * 4/2012 Lanz D9/434
D662,658 S * 6/2012 Nixon D9/707

(71) Applicant: **The Procter & Gamble Company**,
Cincinnati, OH (US)

(Continued)

(72) Inventors: **Luke Anthony Snider**, Cincinnati, OH
(US); **Jack Wesley English, III**,
Liberty Township, OH (US); **Robert
Eugene Heard**, Covington, KY (US);
Amy Meyers Krehbiel, Cincinnati, OH
(US)

FOREIGN PATENT DOCUMENTS

WO DM/083869 5/2014

(73) Assignee: **The Procter & Gamble Company**,
Cincinnati, OH (US)

OTHER PUBLICATIONS

U.S. Appl. No. 15/099,670, filed Apr. 15, 2016, Luke Anthony
Snider.

(Continued)

(**) Term: **15 Years**

Primary Examiner — Sandra Morris
(74) *Attorney, Agent, or Firm* — Melissa Krasovec;
Leonard W Lewis; Steven W Miller

(21) Appl. No.: **29/561,343**

(57) **CLAIM**

The ornamental design for container having surface indicia,
as shown and described.

(22) Filed: **Apr. 15, 2016**

(51) **LOC (11) Cl.** **09-01**

DESCRIPTION

(52) **U.S. Cl.**

USPC **D9/600**; D9/434

(58) **Field of Classification Search**

USPC D3/270, 271.1–271.4; D7/510, 514–520,
D7/599, 604, 613, 619.2, 623, 628;
D9/600, 414, 418, 424, 434, 702–713,
D9/500, 516; 206/457, 459.5, 527;
215/381–384, 400; D14/485, 489, 492;
D20/23, 28, 29

CPC B65D 5/4258; B65D 81/60; B65D 81/365;
B65D 81/366; B65D 81/368; B65D
2203/00; B65D 2203/02

See application file for complete search history.

FIG. 1 is a rear perspective view of a first embodiment of the
container having surface indicia;
FIG. 2 is a rear view thereof;
FIG. 3 is a right side view thereof;
FIG. 4 is a front view thereof;
FIG. 5 is a left side view thereof;
FIG. 6 is a top view thereof;
FIG. 7 is a bottom view thereof.
FIG. 8 is a rear perspective view of a second embodiment of
the container having surface indicia;
FIG. 9 is a rear view thereof;
FIG. 10 is a right side view thereof;
FIG. 11 is a front view thereof;
FIG. 12 is a left side view thereof;
FIG. 13 is a top view thereof; and,
FIG. 14 is a bottom view thereof.

The broken lines shown in the drawings are for illustrative
purposes only and form no part of the claimed design.

(56) **References Cited**

U.S. PATENT DOCUMENTS

D639,183 S * 6/2011 Nixon D9/707
D639,184 S * 6/2011 Nixon D9/707
D649,453 S * 11/2011 Gonzalez D9/434

1 Claim, 12 Drawing Sheets

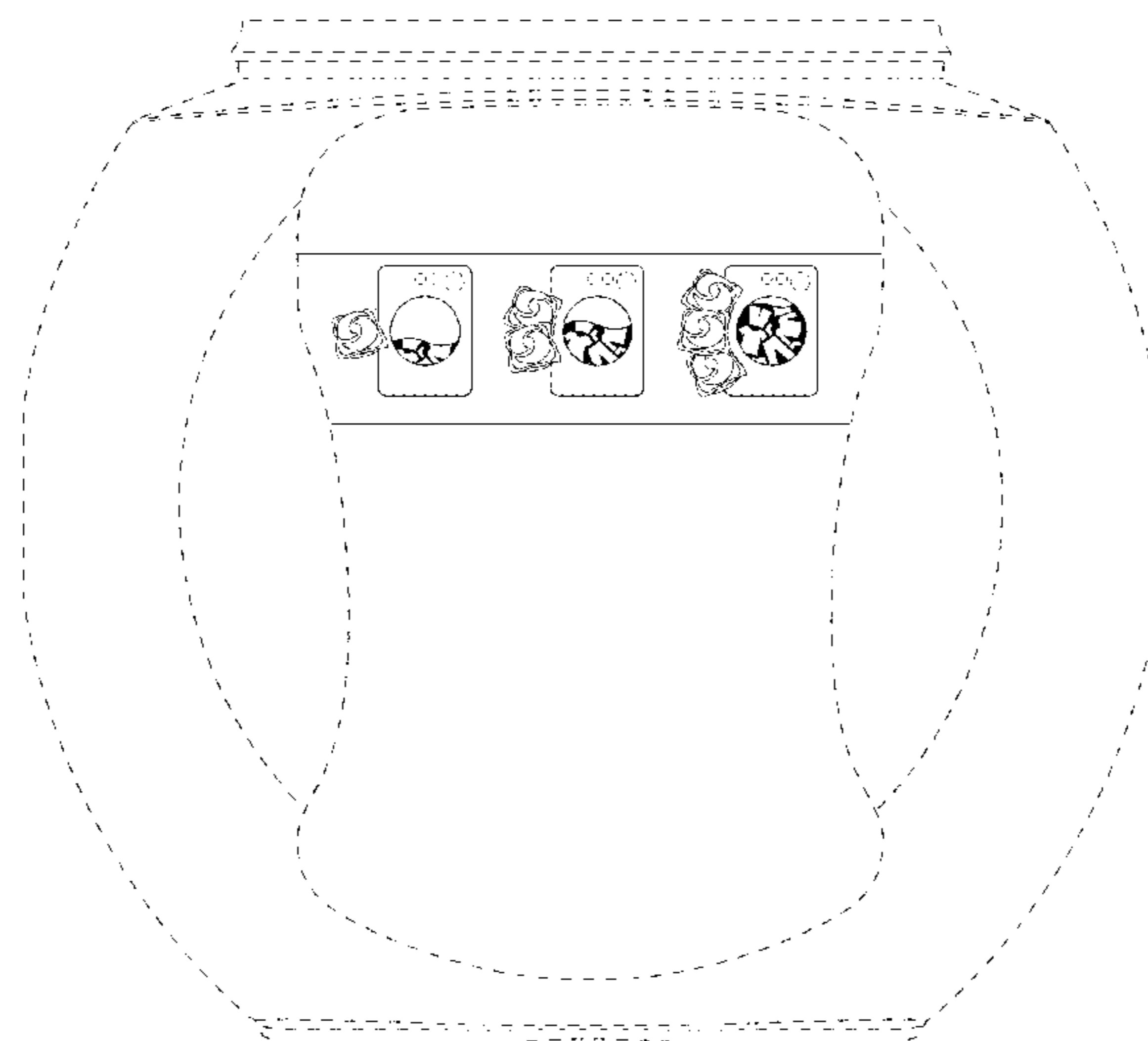

(56)

References Cited

U.S. PATENT DOCUMENTS

D662,659 S * 6/2012 Nixon D9/707
D716,650 S * 11/2014 Robinson D9/434
D745,393 S * 12/2015 Robinson D9/434

OTHER PUBLICATIONS

U.S. Appl. No. 15/099,673, filed Apr. 15, 2016, Jack Wesley English III.

U.S. Appl. No. 29/561,344, filed Apr. 15, 2016, Luke Anthony Snider.

U.S. Appl. No. 29/561,346, filed Apr. 15, 2016, Luke Anthony Snider.

Commercially available Products, photographs taken on Nov. 23, 2015. (6 packages).

Instructions on a top-loading washing machine. (Photograph taken on Nov. 17, 2016).

American Cleaning Institute, High Efficiency Washers and Dryers—Working in Harmony to Save Energy and Water, pp. 1-16, © 2005, 2010 American Cleaning Institute. www.cleaninginstitute.org.

* cited by examiner

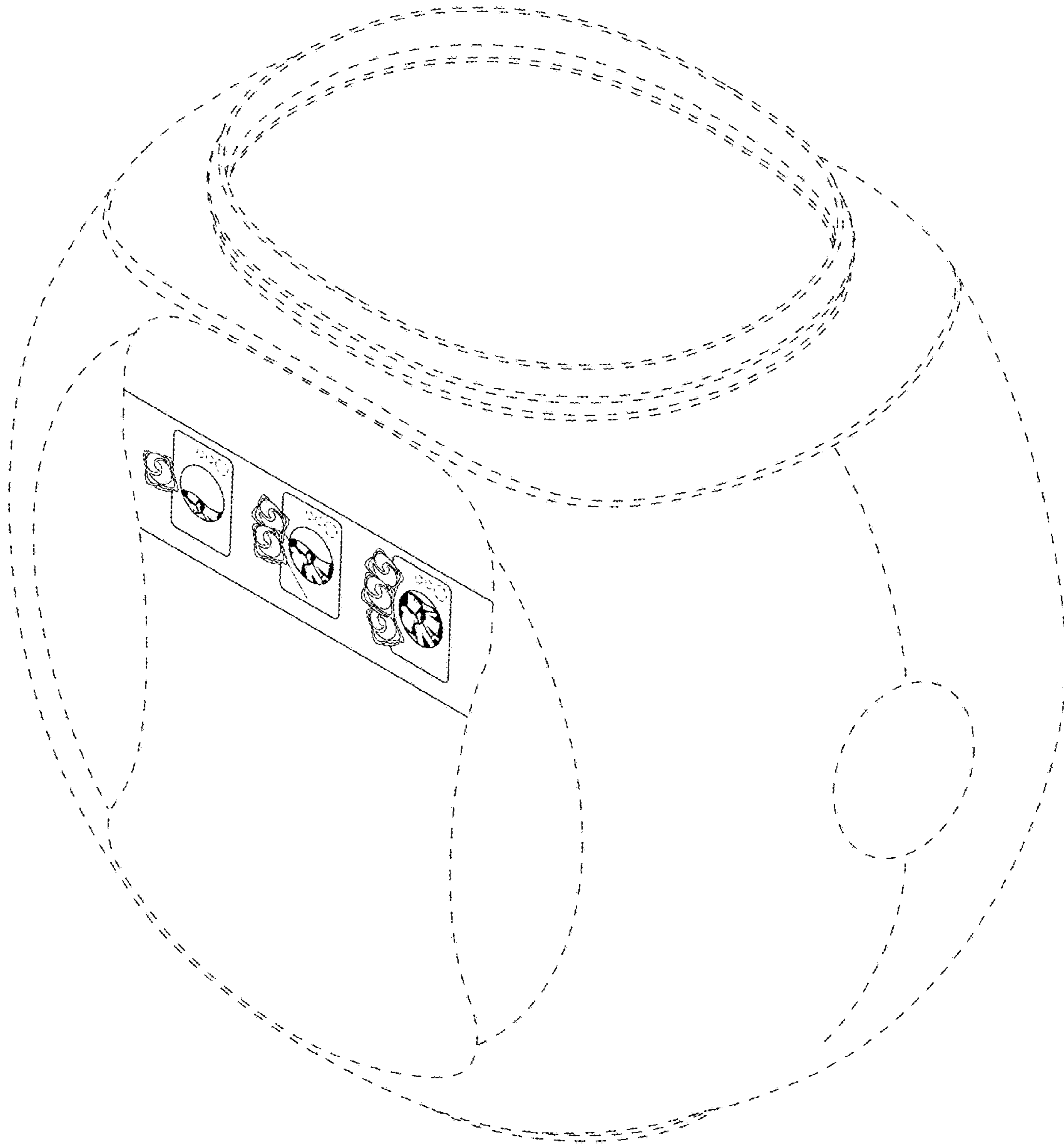

FIG. 1

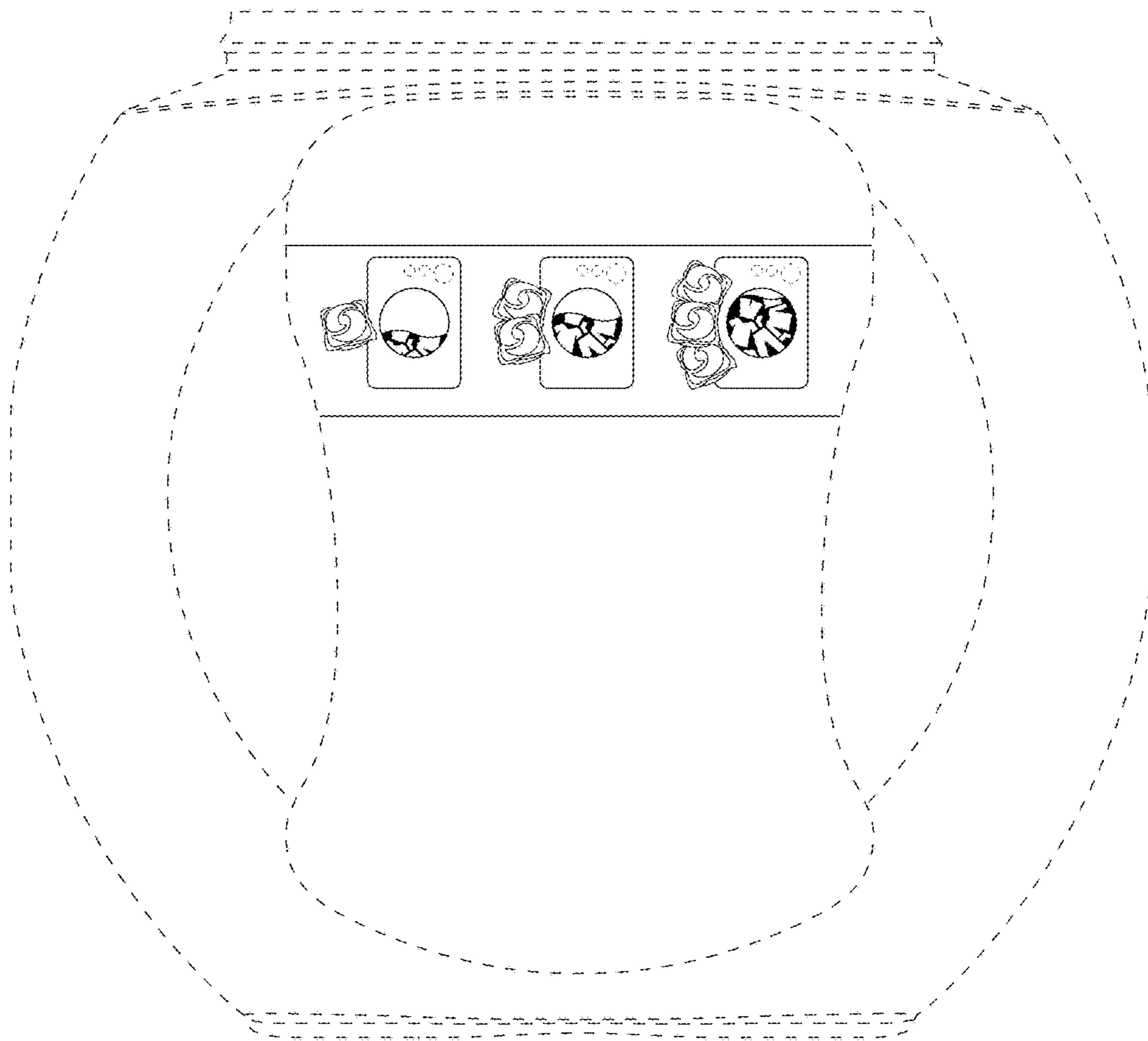

FIG. 2

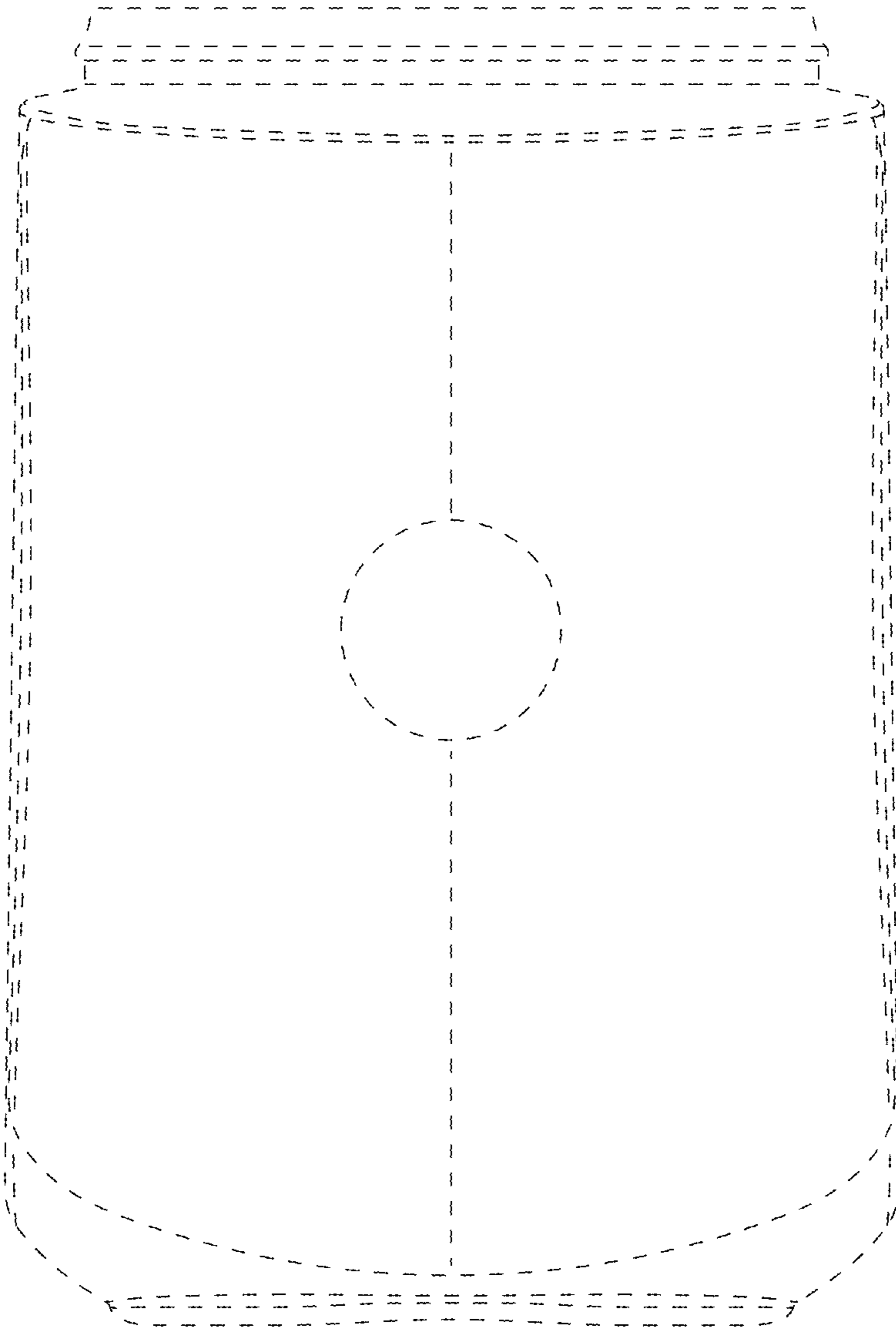

FIG. 3

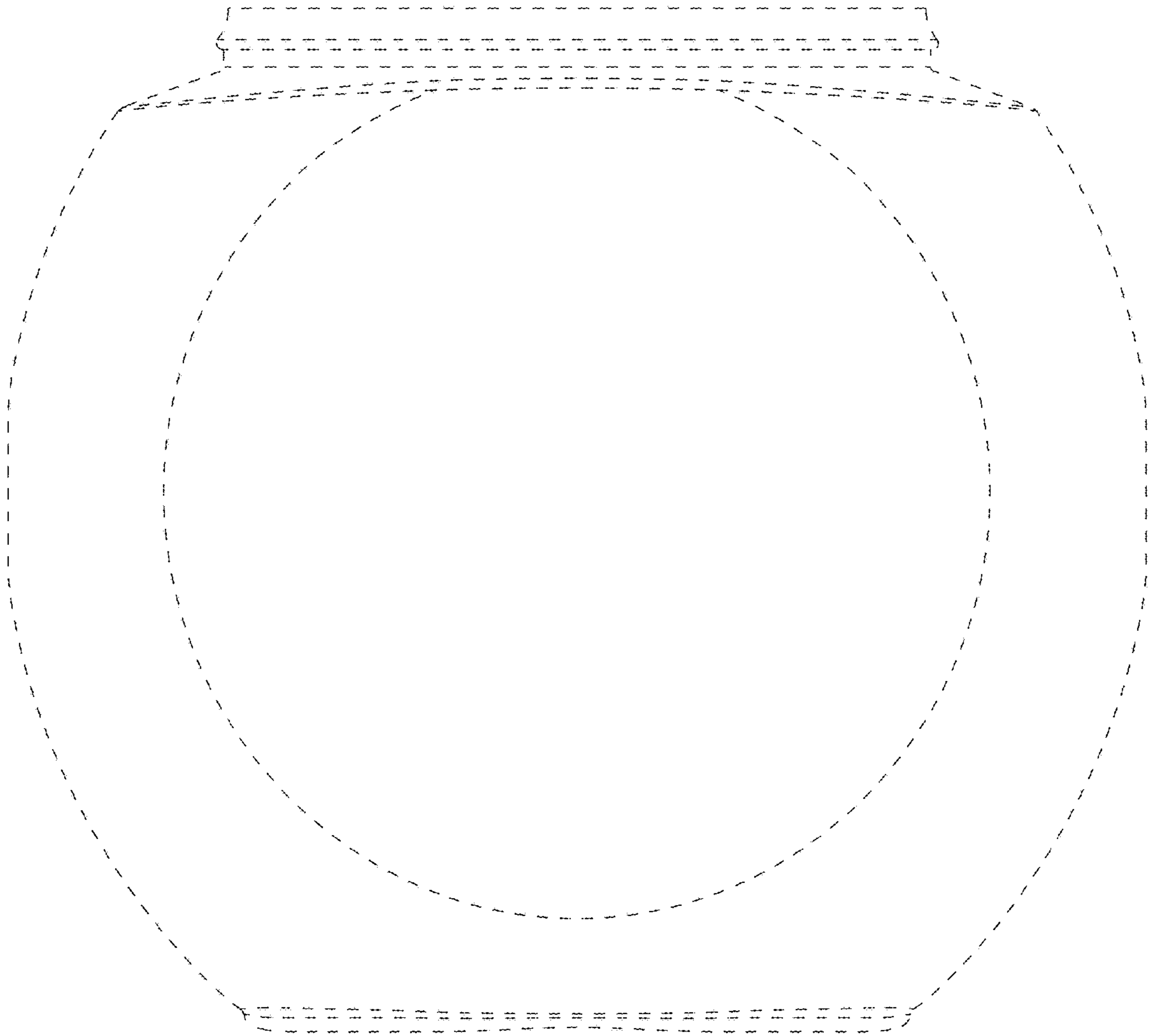

FIG. 4

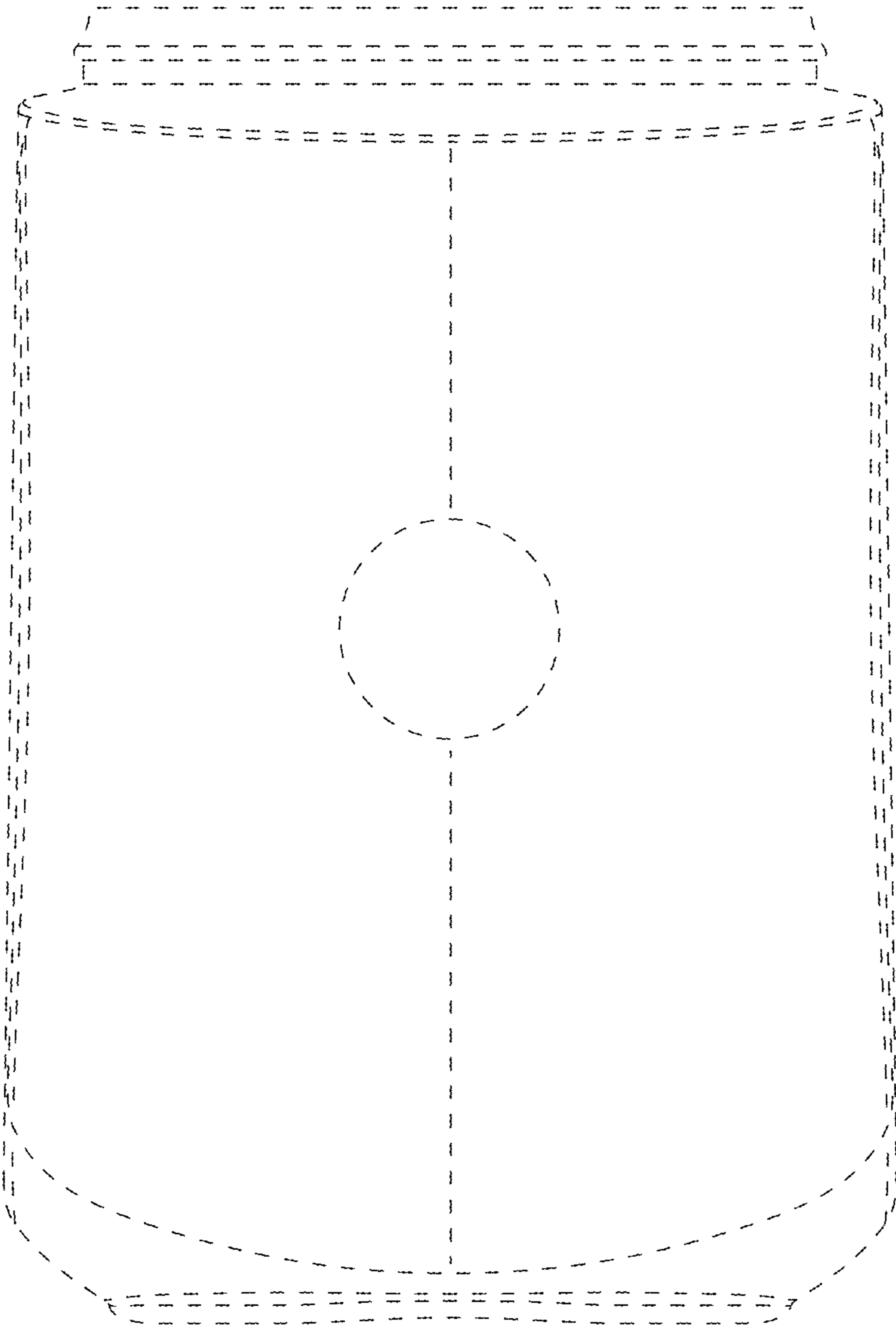

FIG. 5

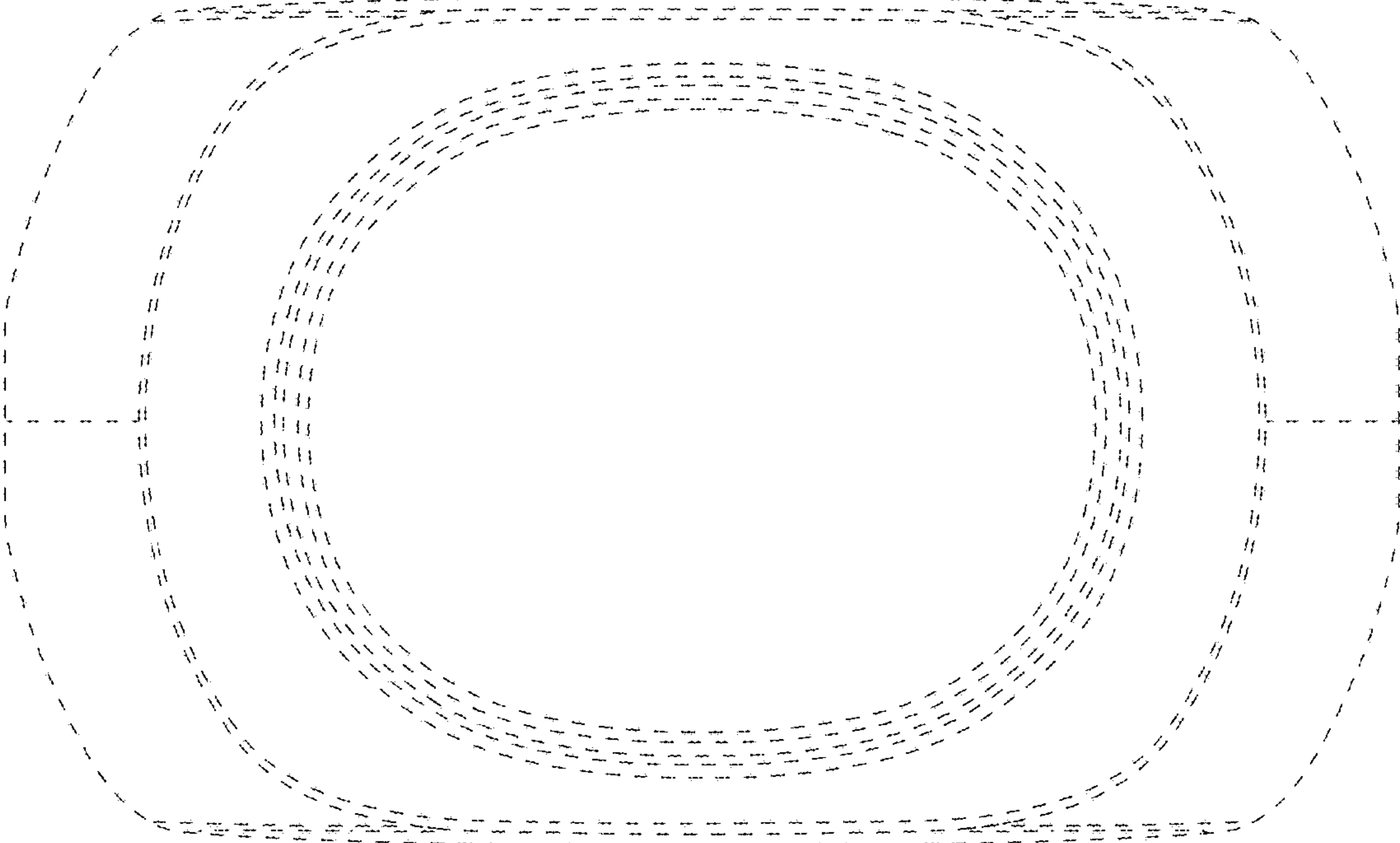

FIG. 6

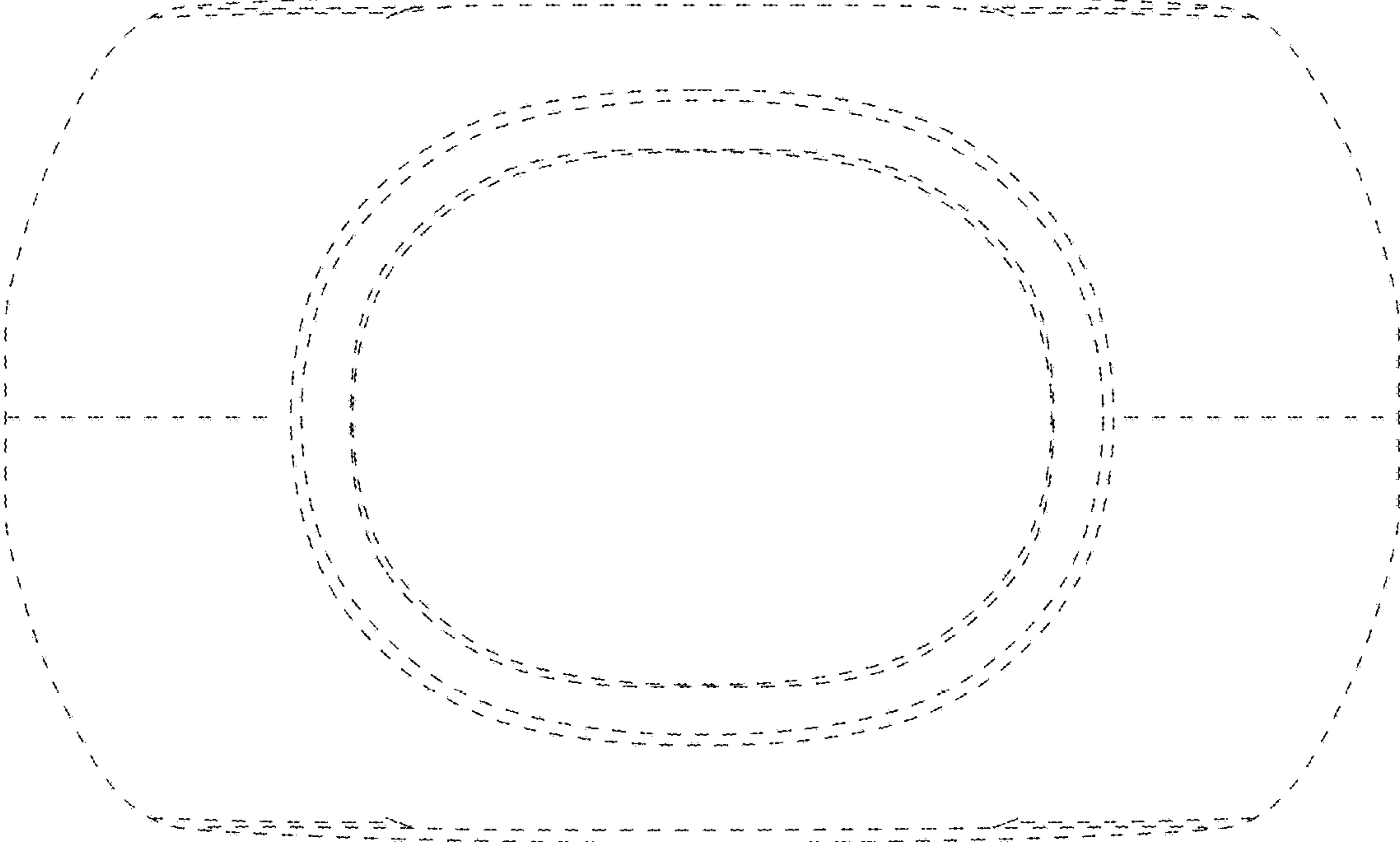

FIG. 7

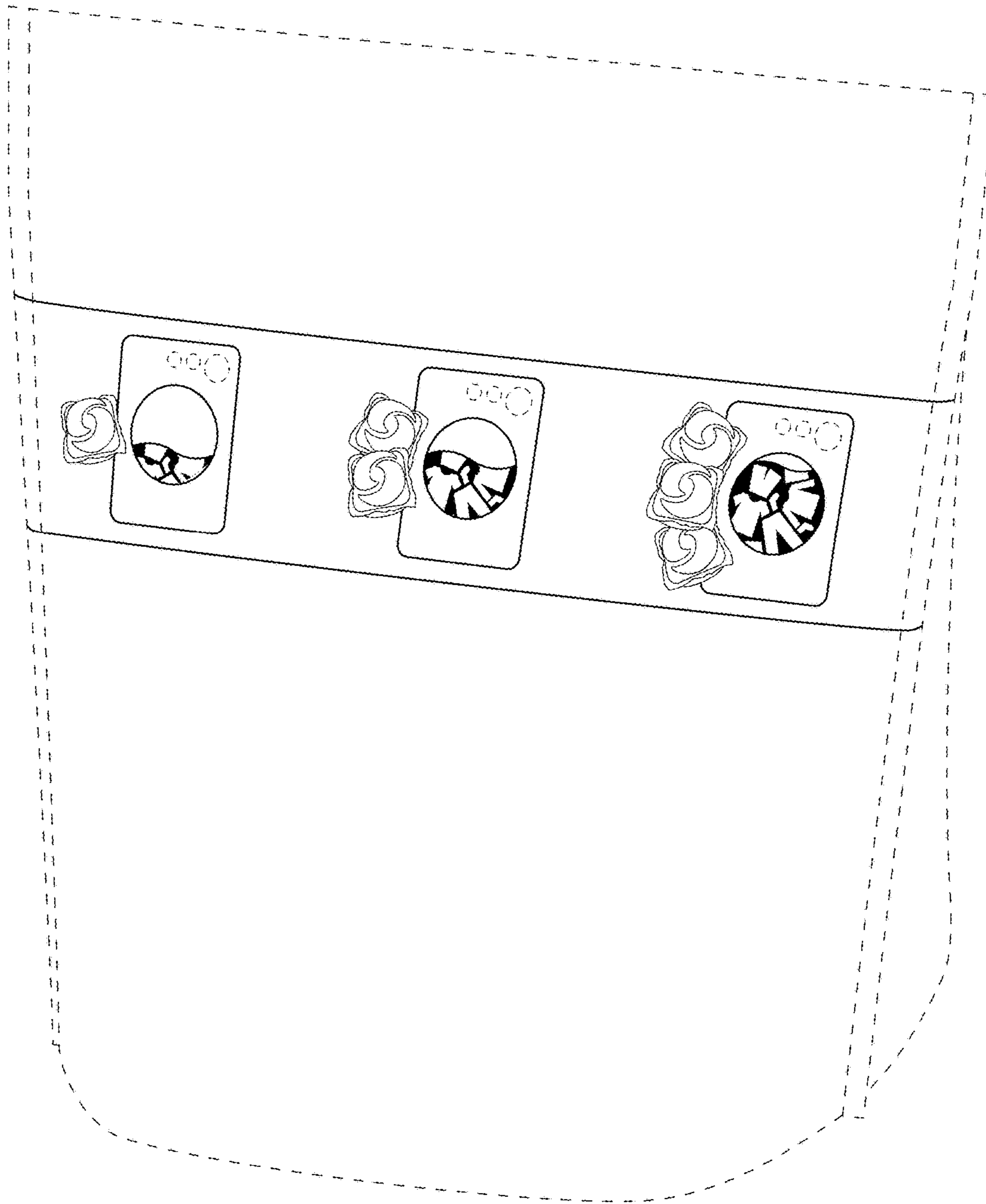

FIG. 8

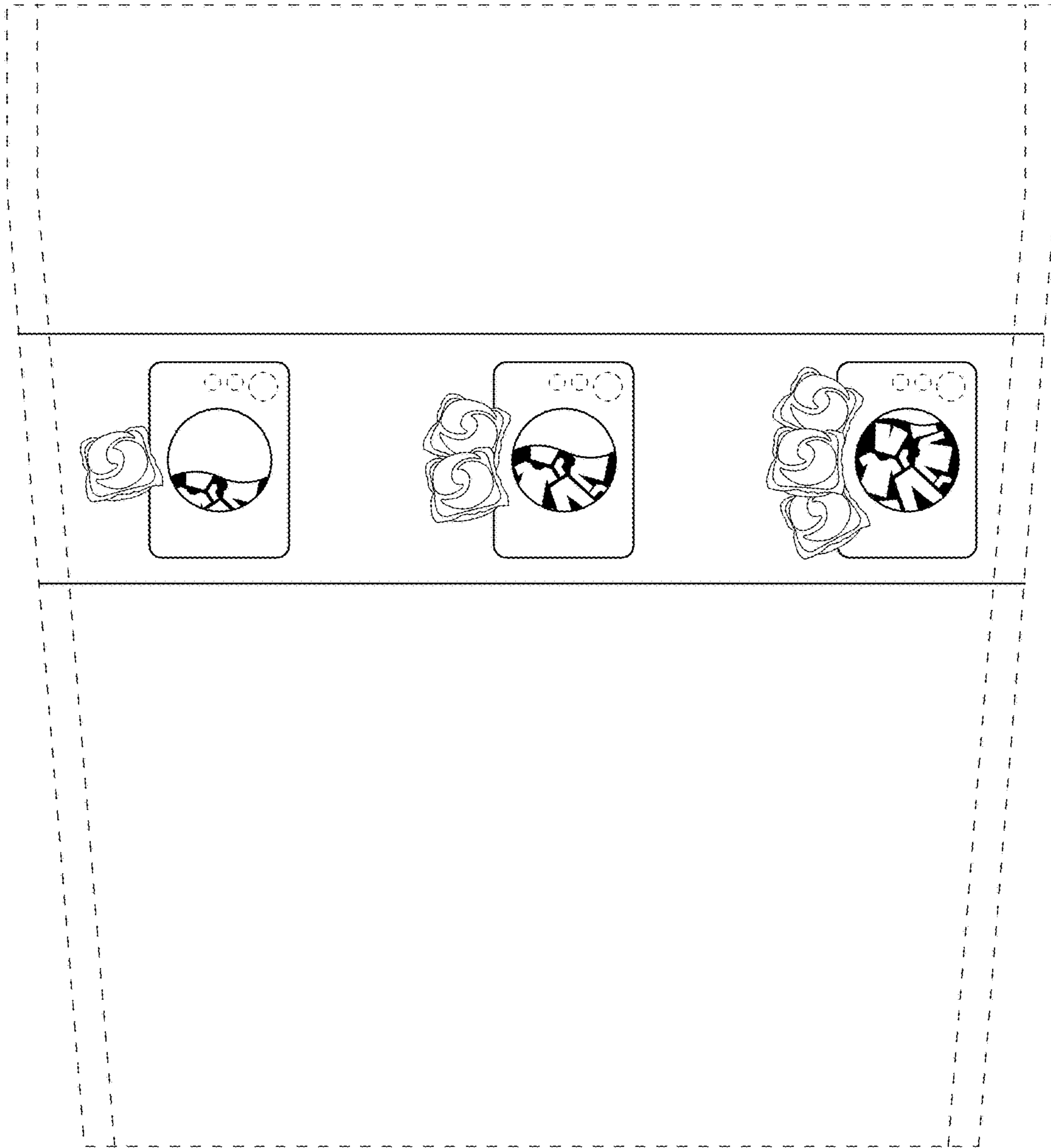

FIG. 9

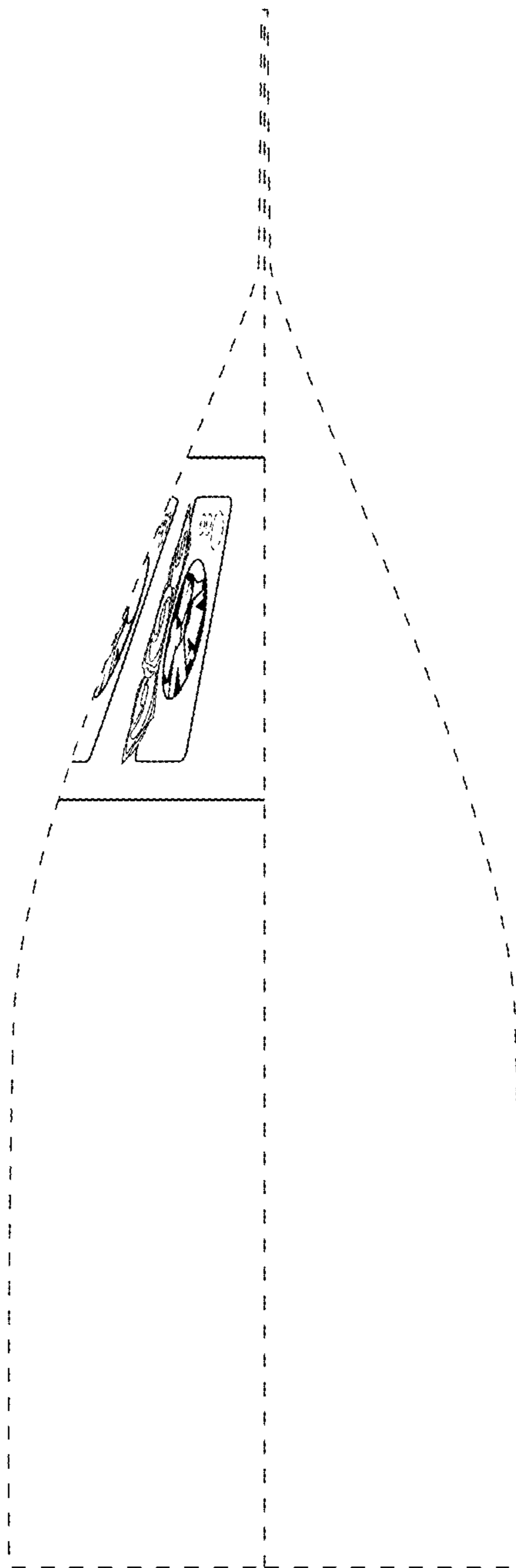

FIG. 10

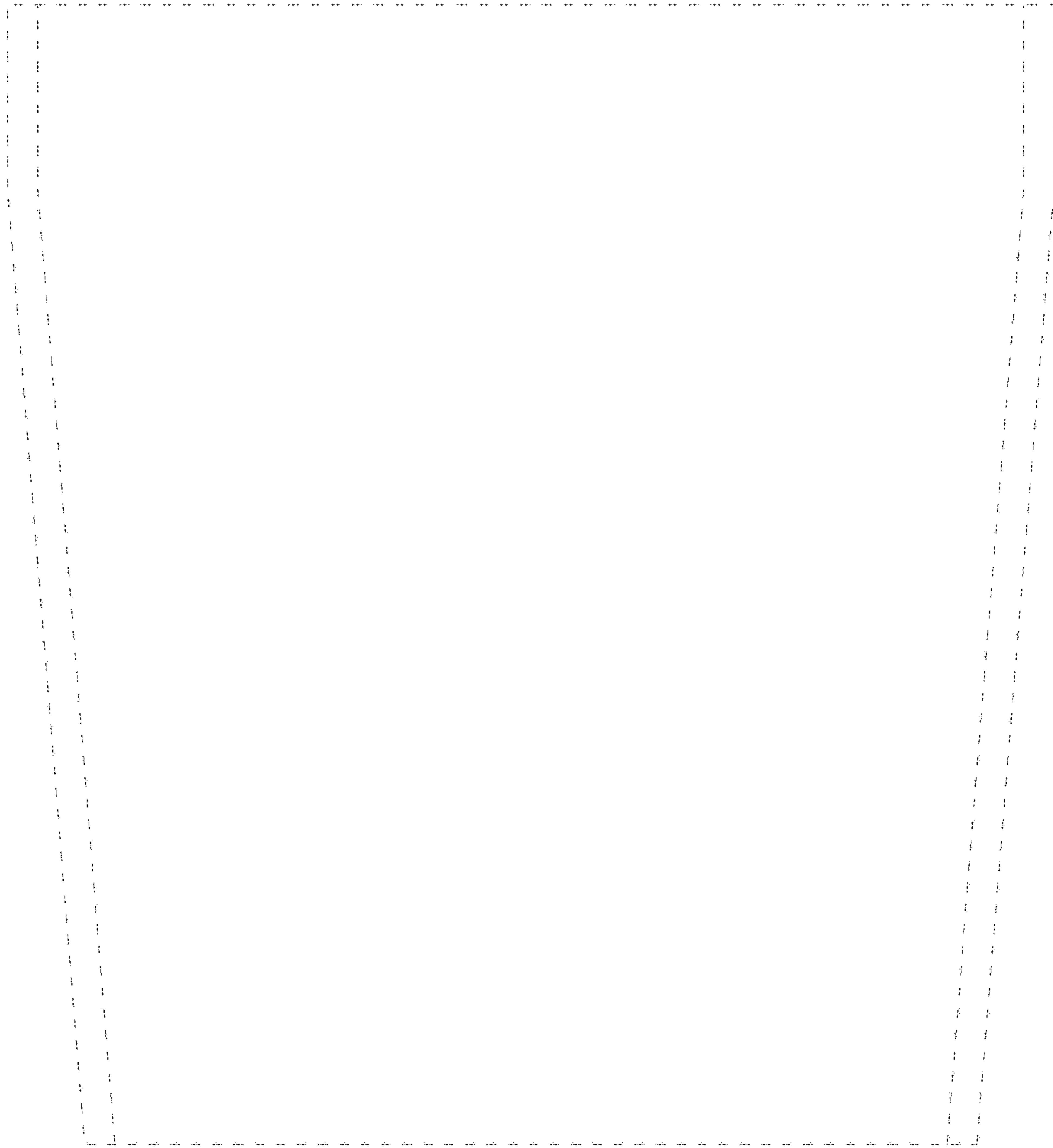

FIG. 11

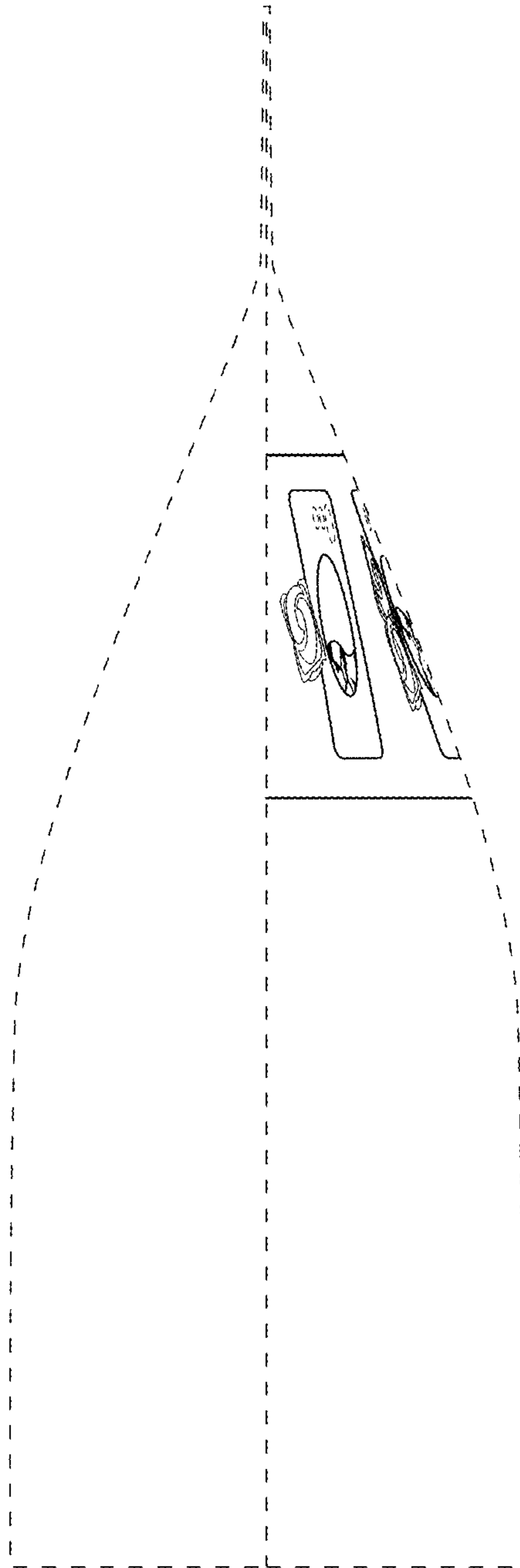

FIG. 12

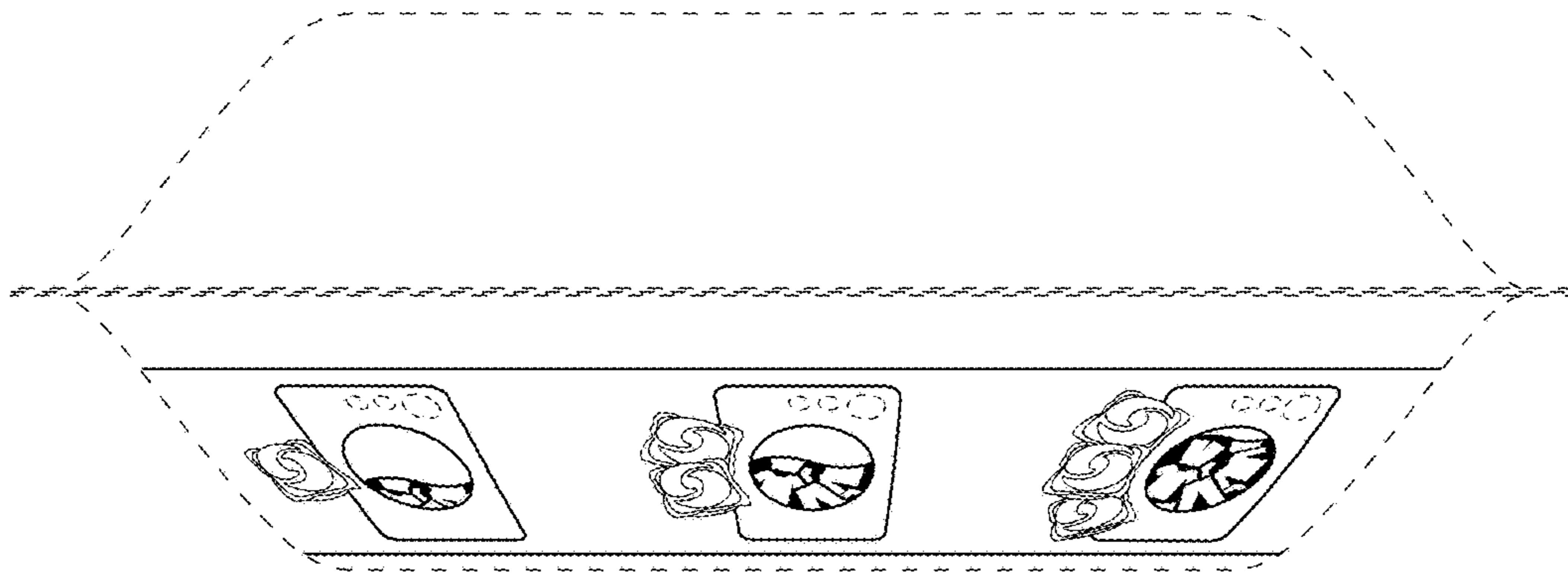

FIG. 13



FIG. 14