



US00D811207S

(12) **United States Design Patent** (10) **Patent No.:** **US D811,207 S**  
**Votel et al.** (45) **Date of Patent:** **\*\* \*Feb. 27, 2018**

- (54) **COIL LANYARD**
- (71) Applicant: **Tenacious Holdings, Inc.**, St. Paul, MN (US)
- (72) Inventors: **Thomas Votel**, Sunfish Lake, MN (US); **Nate Bohmbach**, Lakeville, MN (US)
- (73) Assignee: **Tenacious Holdings, Inc.**, St. Paul, MN (US)
- (\*) Notice: This patent is subject to a terminal disclaimer.
- (\*\*) Term: **15 Years**
- (21) Appl. No.: **29/582,718**
- (22) Filed: **Oct. 29, 2016**

**Related U.S. Application Data**

- (63) Continuation of application No. 29/516,684, filed on Feb. 5, 2015, now Pat. No. Des. 775,517.
- (51) **LOC (11) Cl.** ..... **08-08**
- (52) **U.S. Cl.**  
USPC ..... **D8/382**
- (58) **Field of Classification Search**  
USPC ..... D8/382, 383, 394, 349, 399; D29/101.1, D29/122, 129  
CPC ..... A45F 2005/006; A45F 5/00; A45F 5/02; A45F 5/021; A45F 2005/025; A45F 2005/027; A45F 2200/0575; A01K 27/005; B66C 1/36; F16B 45/00  
See application file for complete search history.

**References Cited**

**U.S. PATENT DOCUMENTS**

- 5,600,873 A \* 2/1997 May ..... G02C 3/003 200/330
- D530,671 S \* 10/2006 Reed ..... D13/147

- 7,320,159 B2 \* 1/2008 Petzl ..... F16B 45/02 24/599.5
- D615,393 S \* 5/2010 Cunningham, Jr. .... D8/394
- D706,123 S \* 6/2014 Mathews ..... D8/382
- D775,517 S \* 1/2017 Votel ..... D8/382
- 2003/0213823 A1 \* 11/2003 Papovitch ..... A45F 5/02 224/254
- 2004/0200436 A1 \* 10/2004 Staack ..... A01K 1/04 119/792
- 2009/0127302 A1 \* 5/2009 Pruitt ..... B25B 23/00 224/219
- 2010/0005632 A1 \* 1/2010 Pigozzi ..... A44B 11/266 24/3.13
- 2010/0037833 A1 \* 2/2010 Joung ..... A01K 27/005 119/798
- 2011/0119800 A1 \* 5/2011 Garrido ..... A41D 13/0012 2/2.15
- 2017/0119137 A1 \* 5/2017 Cirincione, II ..... A45F 5/00

\* cited by examiner

*Primary Examiner* — Sandra Snapp

*Assistant Examiner* — Ieisha Price

(74) *Attorney, Agent, or Firm* — Skaar Ulbrich Macari, P.A.

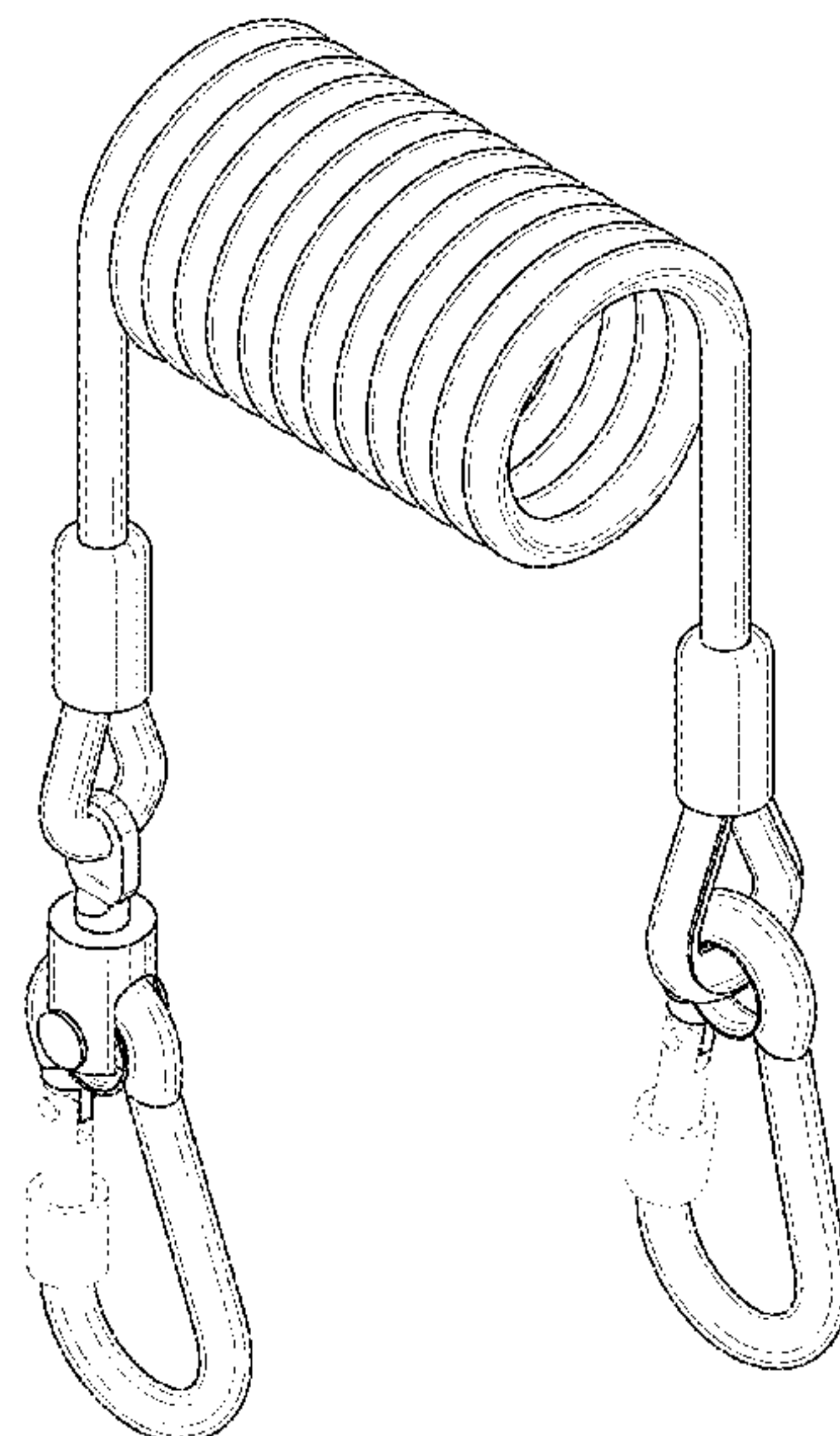
(57) **CLAIM**

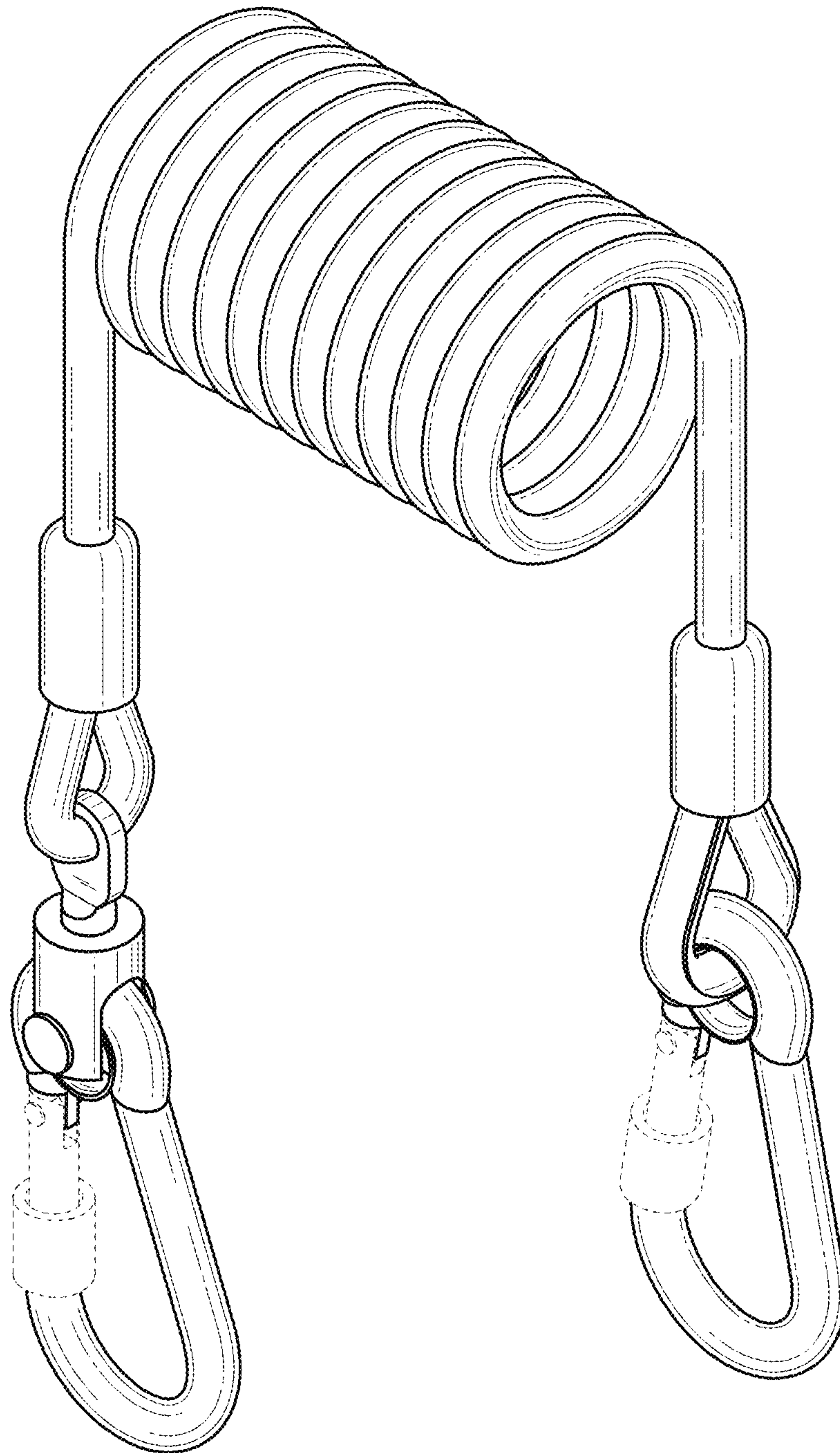
We claim the ornamental design for a coil lanyard, as shown and described.

**DESCRIPTION**

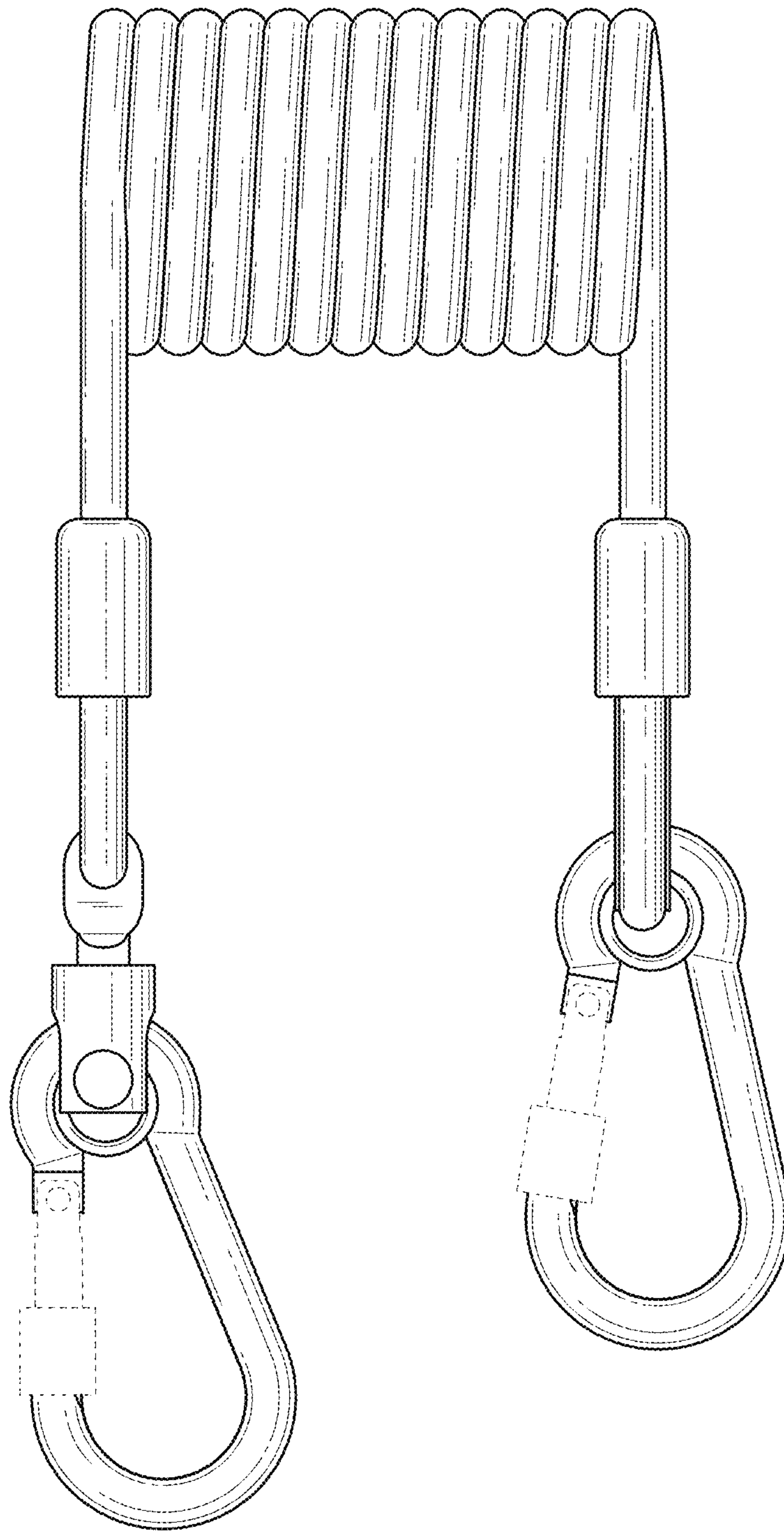
FIG. 1 is a perspective of our coil lanyard showing our new design;  
 FIG. 2 is a front elevation view thereof;  
 FIG. 3 is a rear elevation view thereof;  
 FIG. 4 is a side elevation view thereof;  
 FIG. 5 is an opposite side elevation view thereof;  
 FIG. 6 is a top plan view thereof; and,  
 FIG. 7 is a bottom plan view thereof.  
 The broken lines in the drawings illustrate features of the article that form no part of the claimed design.

**1 Claim, 6 Drawing Sheets**



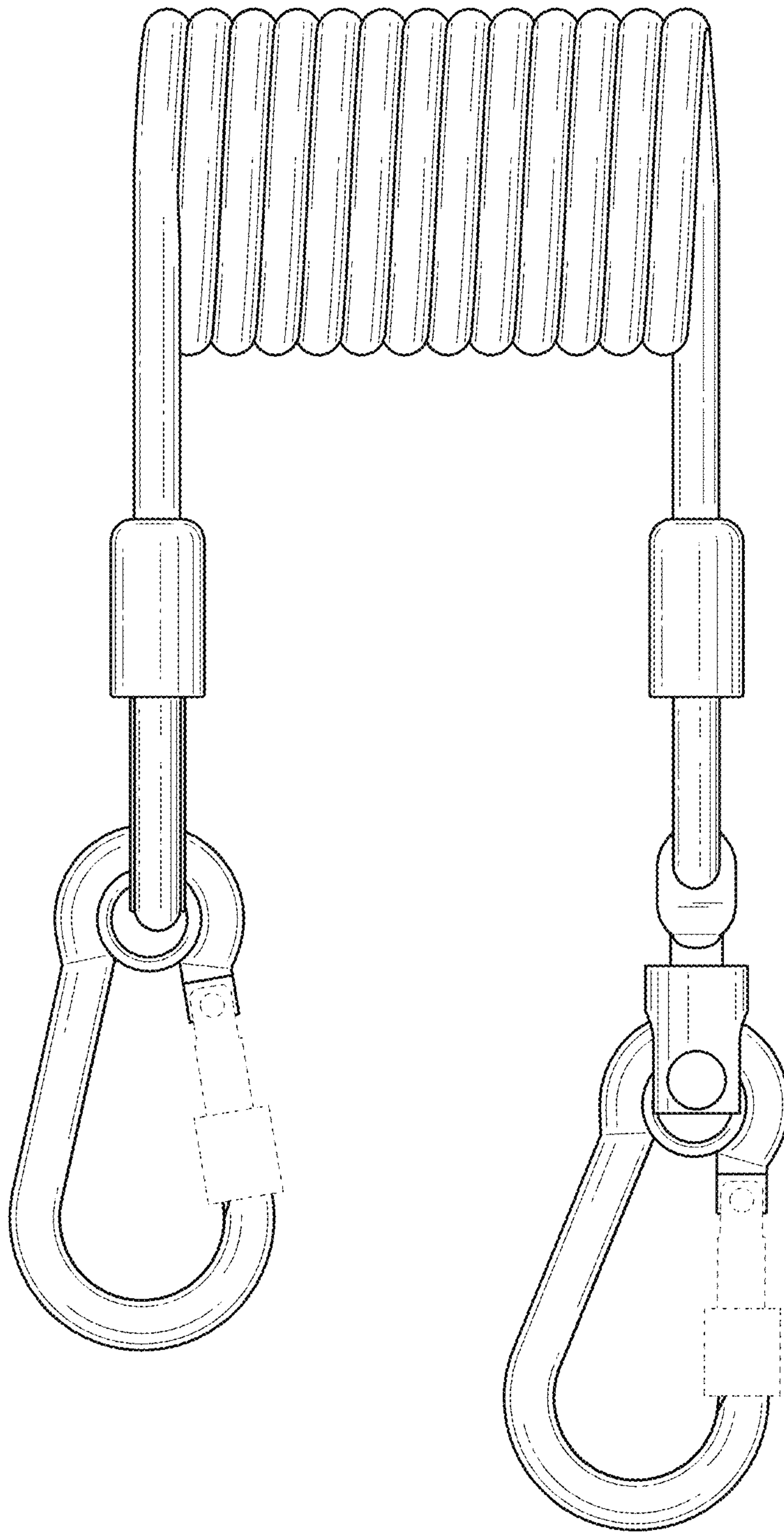


**Fig. 1**



**Fig. 2**





**Fig. 3**

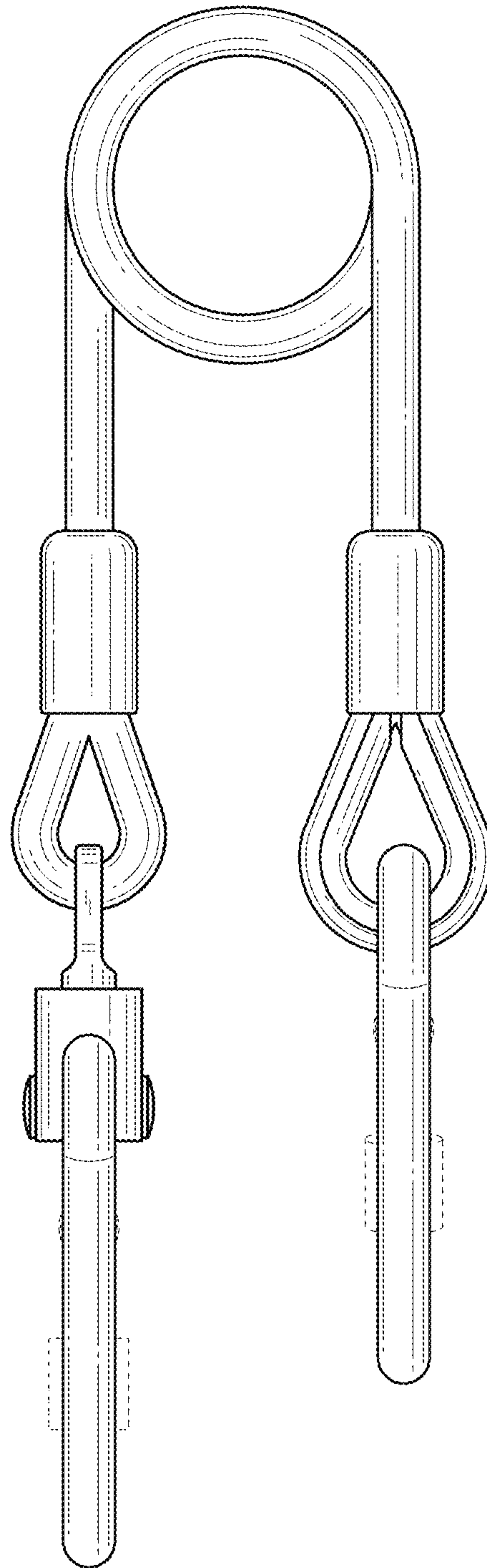
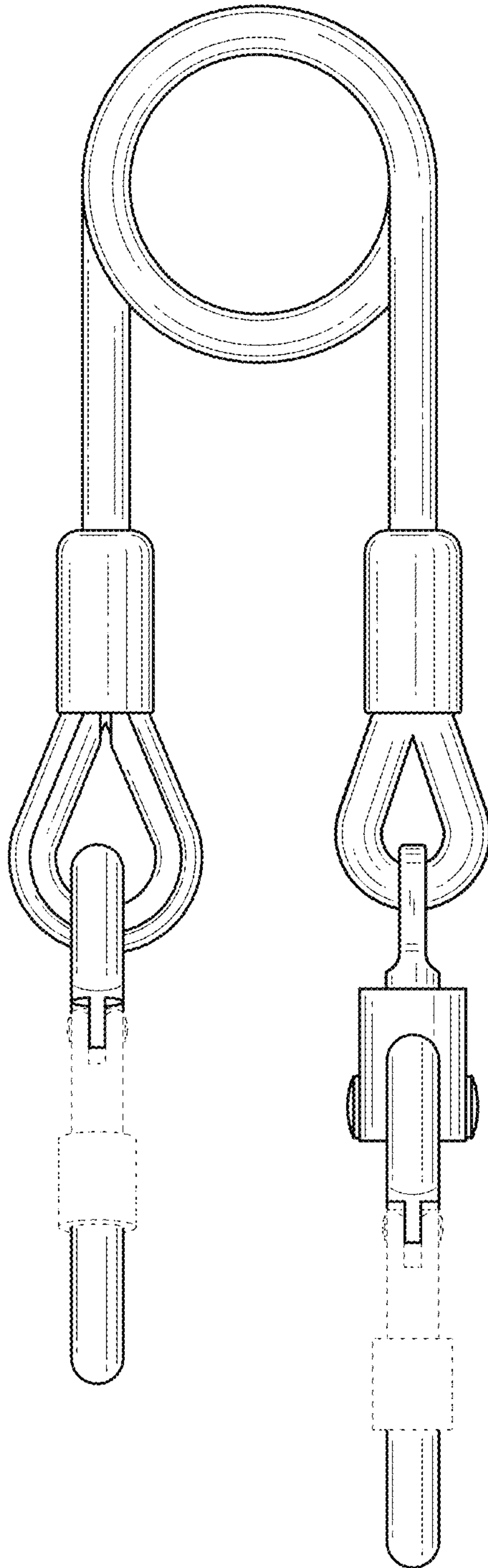
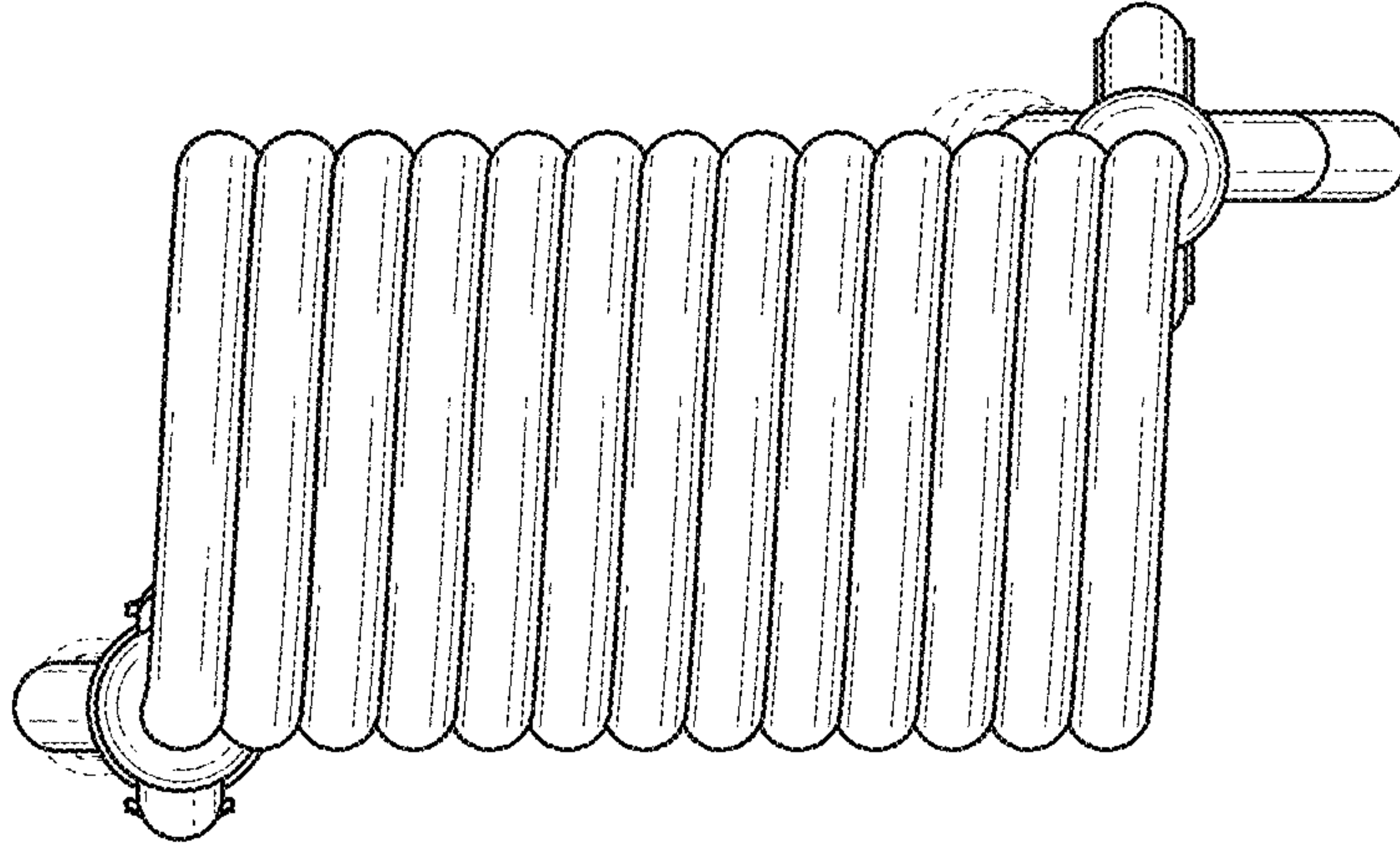


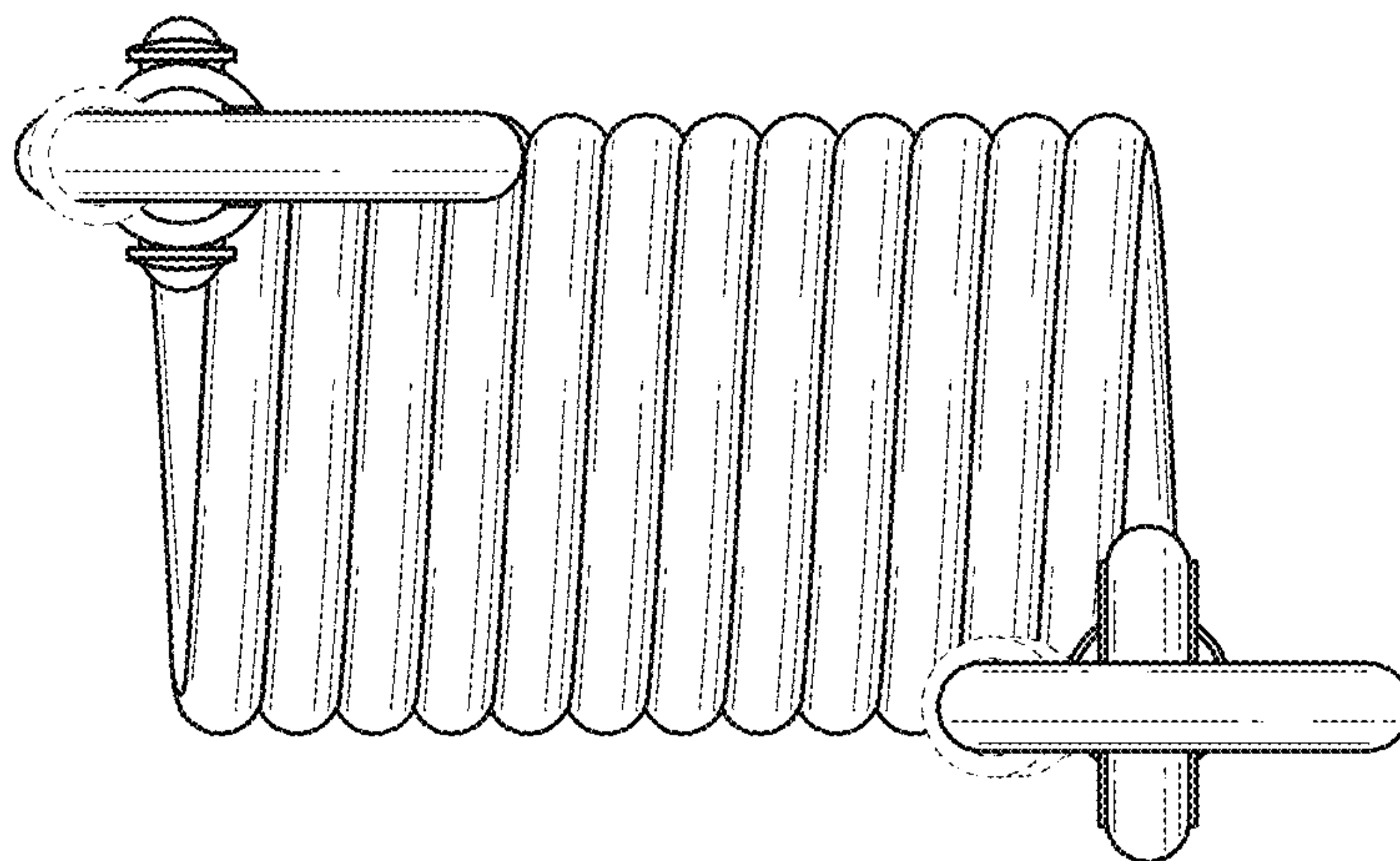
Fig. 4



**Fig. 5**



**Fig. 6**



**Fig. 7**