



US00D811185S

(12) **United States Design Patent**  
**Yuan**

(10) **Patent No.:** **US D811,185 S**  
(45) **Date of Patent:** **\*\* Feb. 27, 2018**

(54) **FOLDING RIVET GUN**

(71) Applicant: **Yuyao Tangwen Tool Co., Ltd.**, Yuyao (CN)

(72) Inventor: **Jianming Yuan**, Yuyao (CN)

(73) Assignee: **Yuyao Tangwen Tool Co., Ltd.**, Yuyao (CN)

(\*\*) Term: **15 Years**

(21) Appl. No.: **29/580,423**

(22) Filed: **Oct. 9, 2016**

(51) **LOC (11) Cl.** ..... **08-05**

(52) **U.S. Cl.**  
USPC ..... **D8/51; D8/68**

(58) **Field of Classification Search**  
USPC ..... D8/51, 61, 67, 68  
CPC . B21J 15/043; B21J 15/22; B21J 15/36; B21J 15/326  
See application file for complete search history.

6,732,563 B1 \* 5/2004 Chen ..... B21J 15/043  
29/243.53

D502,372 S \* 3/2005 Ziegert ..... D8/61

D503,327 S \* 3/2005 Ziegert ..... D8/69

D506,115 S \* 6/2005 King ..... D8/54

6,978,526 B1 \* 12/2005 Lin ..... B21J 15/105  
29/243.523

D521,340 S \* 5/2006 Lin ..... D8/68

7,082,657 B1 \* 8/2006 Lin ..... B21J 15/043  
29/243.523

7,284,404 B2 \* 10/2007 Lin ..... B25B 27/0014  
29/243.525

D588,427 S \* 3/2009 Manak ..... D8/51

D605,491 S \* 12/2009 Mitomi ..... D8/69

7,818,858 B2 \* 10/2010 Daniels ..... F16G 3/16  
198/844.2

D681,413 S \* 5/2013 Kita ..... D8/61

8,443,512 B2 \* 5/2013 Masugata ..... B21J 15/043  
29/243.521

D707,519 S \* 6/2014 Masugata ..... D8/68

D752,936 S \* 4/2016 King ..... D8/68

D781,121 S \* 3/2017 King ..... D8/68

\* cited by examiner

*Primary Examiner* — Darlington Ly  
(74) *Attorney, Agent, or Firm* — Wayne & King LLC

(56) **References Cited**

**U.S. PATENT DOCUMENTS**

D247,214 S \* 2/1978 Wolf ..... D8/51

D256,658 S \* 9/1980 Ewig ..... D8/61

D280,071 S \* 8/1985 Oefinger ..... D23/225

D280,795 S \* 10/1985 Jordan ..... D8/14

5,100,023 A \* 3/1992 Varian ..... B21J 15/32  
221/239

D335,250 S \* 5/1993 Rosier ..... D8/68

D369,732 S \* 5/1996 Rosier ..... D8/68

D369,733 S \* 5/1996 Rosier ..... D8/68

D370,163 S \* 5/1996 Hurd ..... D8/68

D371,299 S \* 7/1996 Rosier ..... D8/68

D407,615 S \* 4/1999 Cerulo ..... D8/51

D423,896 S \* 5/2000 Steiner ..... D8/61

D445,012 S \* 7/2001 Suzuki ..... D8/61

D462,883 S \* 9/2002 Steiner ..... D8/68

(57) **CLAIM**

The ornamental design for a folding rivet gun, as shown and described.

**DESCRIPTION**

FIG. 1 is a perspective view of a folding rivet gun showing my new design;

FIG. 2 is a front elevation view thereof;

FIG. 3 is a rear elevation view thereof;

FIG. 4 is a left side elevation view thereof;

FIG. 5 is a right side elevation view thereof;

FIG. 6 is a top plan view thereof; and,

FIG. 7 is a bottom plan view thereof.

**1 Claim, 7 Drawing Sheets**

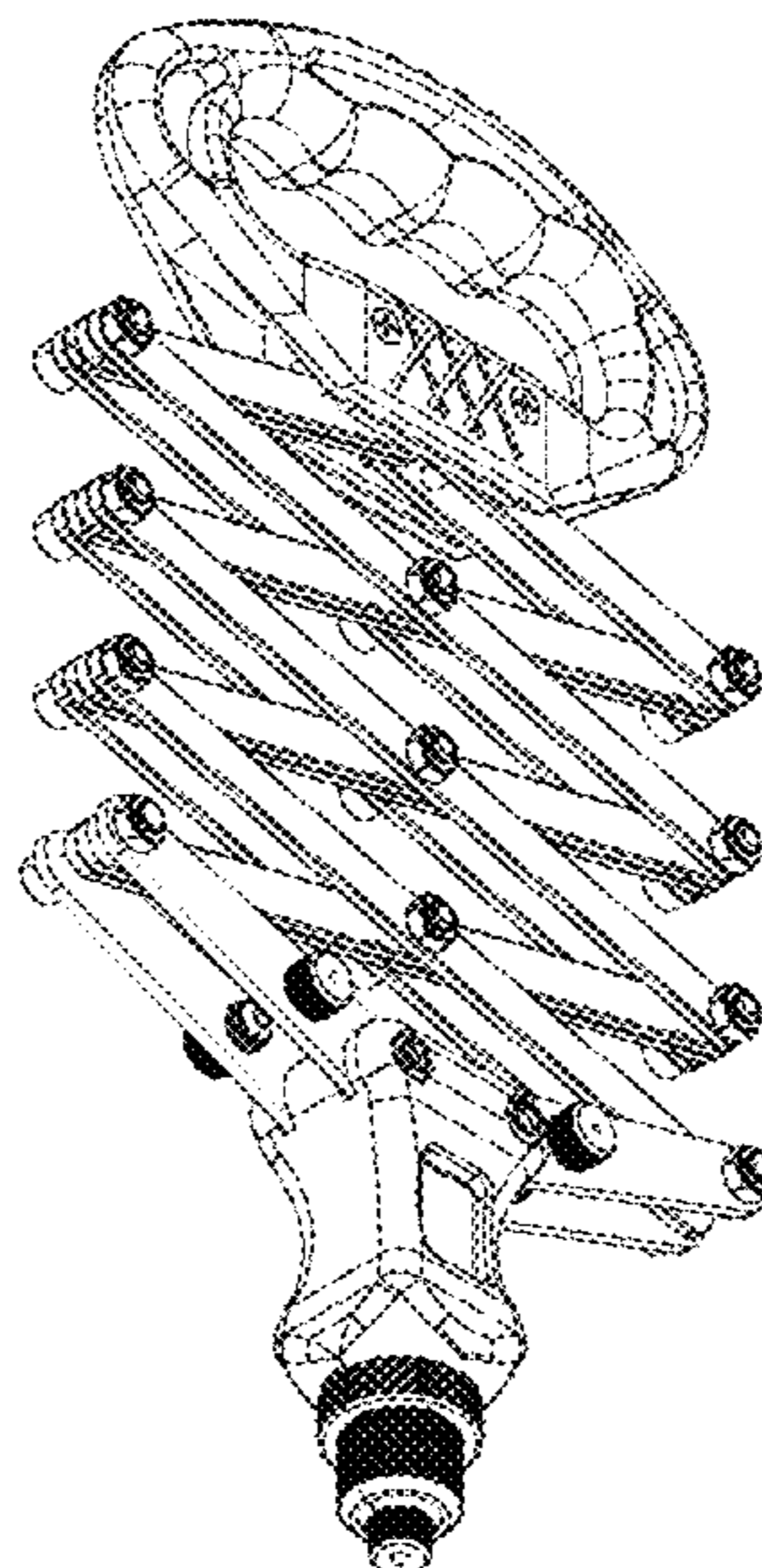

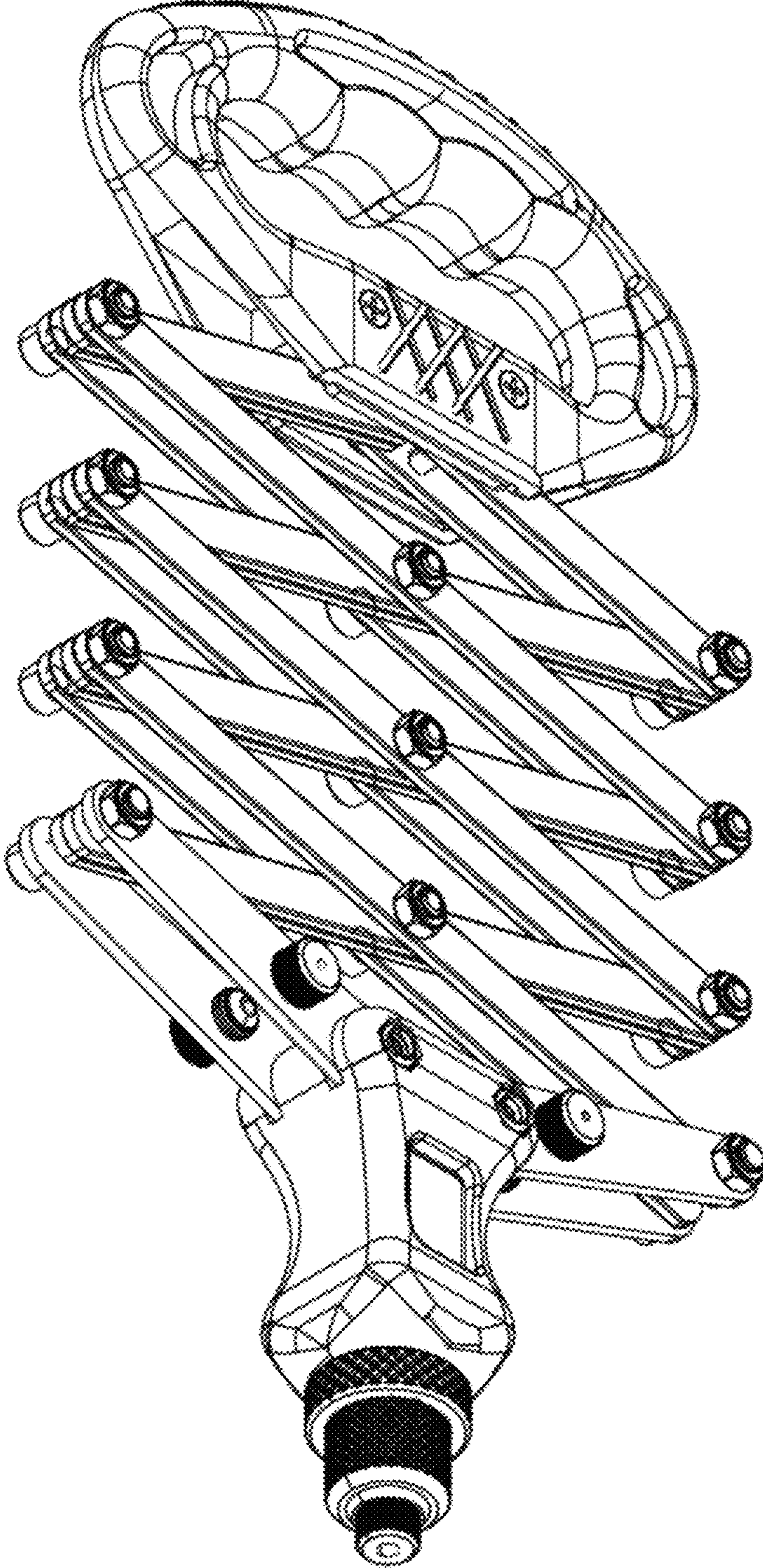

FIG. 1

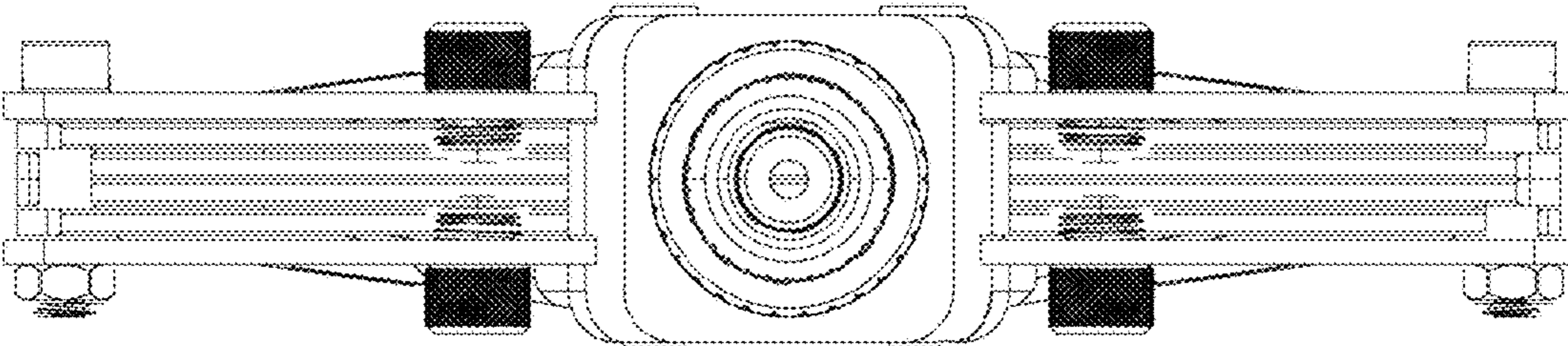

FIG. 2

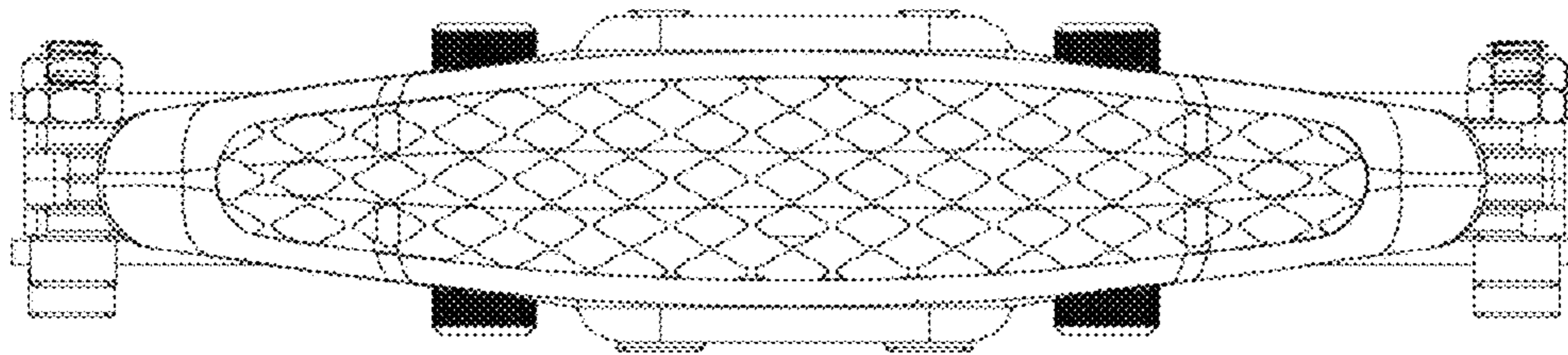

FIG. 3

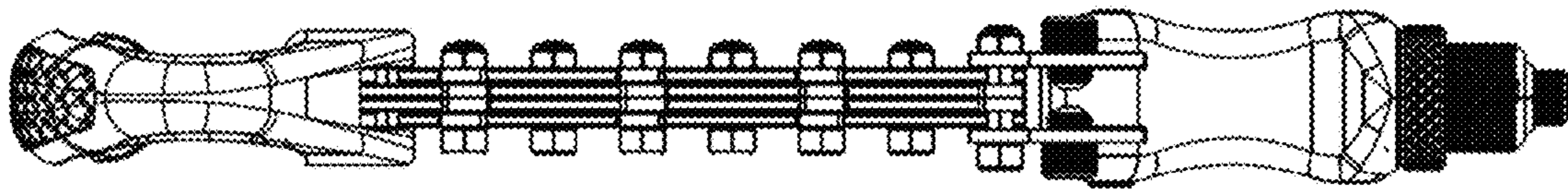

FIG. 4

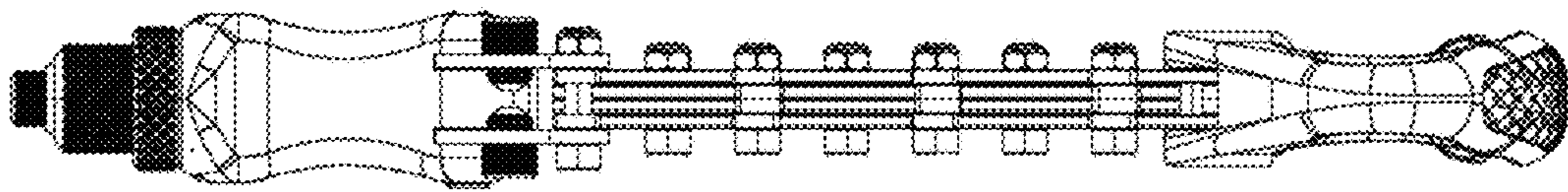

FIG.5

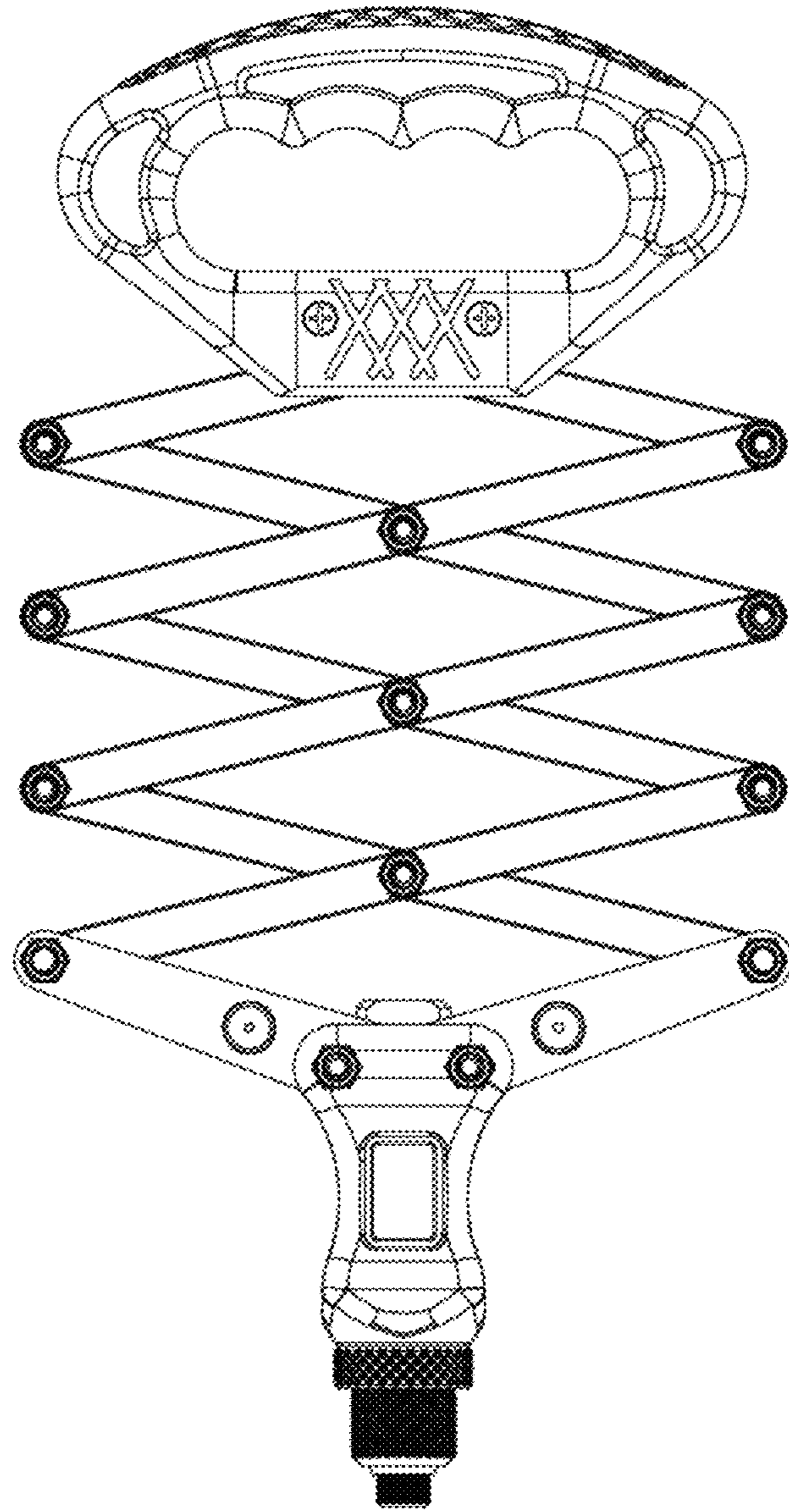

FIG. 6

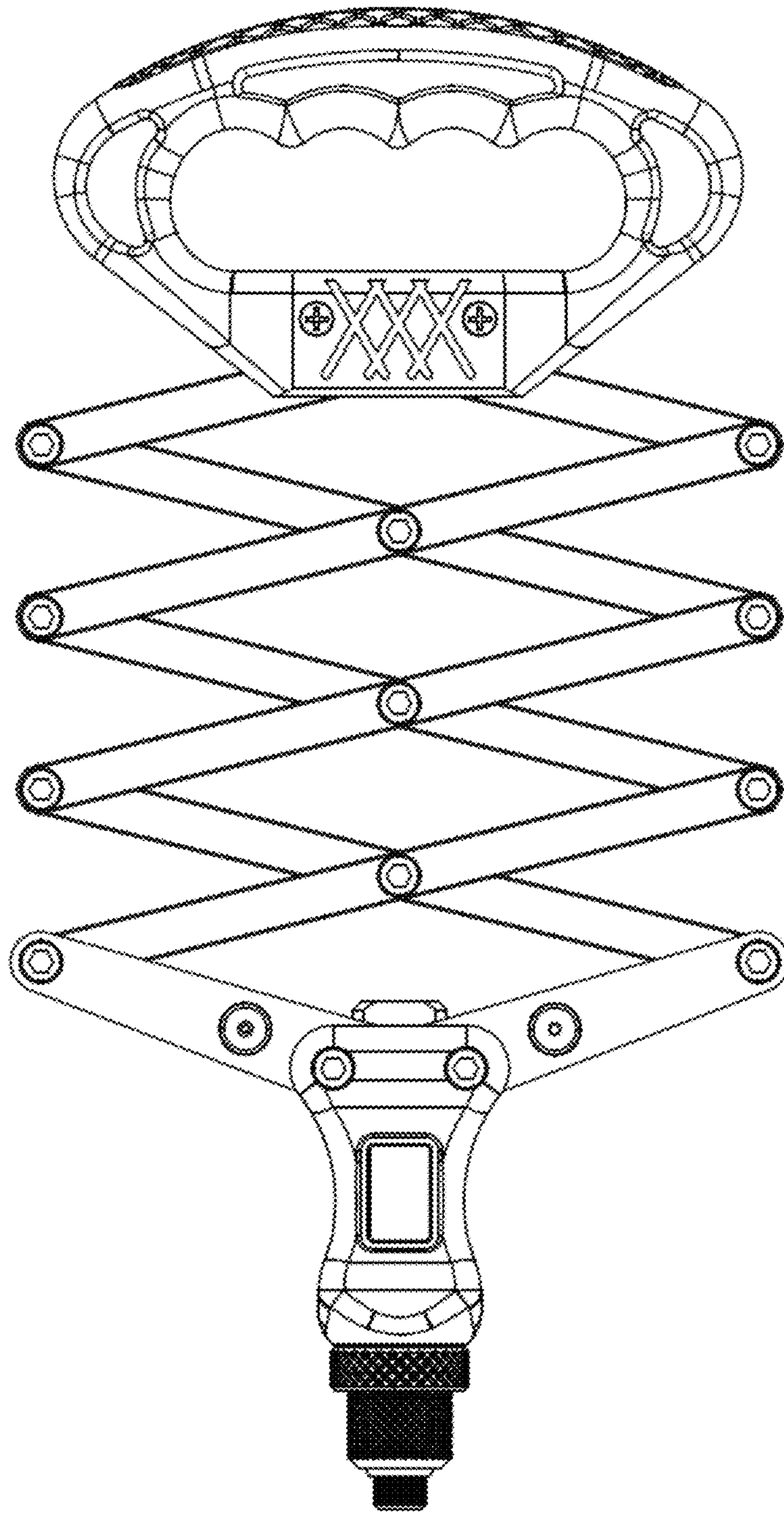

FIG.7