



US00D811101S

(12) **United States Design Patent** (10) **Patent No.:** **US D811,101 S**
Liu (45) **Date of Patent:** **** Feb. 27, 2018**

(54) **FURNITURE SET**

(71) Applicant: **Memo's International Development Limited**, Hong Kong (CN)

(72) Inventor: **Haoying Liu**, Hong Kong (CN)

(73) Assignee: **Memo's International Development Limited**, Central (HK)

(**) Term: **15 Years**

(21) Appl. No.: **29/588,354**

(22) Filed: **Dec. 20, 2016**

(51) **LOC (11) Cl.** **06-01**

(52) **U.S. Cl.**
USPC **D6/335**

(58) **Field of Classification Search**
CPC A47C 7/00; A47C 7/62; A47C 7/18; A47C 7/54; A47C 4/00; A47C 4/028; A47C 4/28; A47C 3/16; A47C 3/04; A47C 3/12; A47C 1/02; A47C 1/14
See application file for complete search history.

(56) **References Cited**

U.S. PATENT DOCUMENTS

D164,682 S *	10/1951	Forward	D6/693
D175,802 S *	10/1955	Sherman	D6/375
RE24,569 E *	11/1958	Thaden	A47C 3/12 297/411.41
3,074,771 A *	1/1963	Wilson	A47B 9/00 108/12
D213,870 S *	4/1969	Hamilton, II et al.	D6/333
3,521,929 A *	7/1970	Pearson	A47C 3/12 297/452.14
D224,951 S *	10/1972	Wilson	D6/364
D383,326 S	9/1997	Hopfer		
D389,347 S *	1/1998	Muller	D6/693.3

D389,674 S *	1/1998	Muller	D6/693.2
D400,362 S *	11/1998	Mourgue	D6/334
D505,281 S *	5/2005	Martin	D6/693

(Continued)

Primary Examiner — Deanna L Pratt

(74) *Attorney, Agent, or Firm* — Muncy, Geissler, Olds & Lowe, P.C.

(57) **CLAIM**

The ornamental design for a furniture set, as shown and described.

DESCRIPTION

FIG. 1 is a front elevation view of the table of my ornamental design for a furniture set;
 FIG. 2 is a rear elevation view thereof;
 FIG. 3 is a top plan view thereof;
 FIG. 4 is a bottom plan view thereof;
 FIG. 5 is a left-side view thereof;
 FIG. 6 is a right-side view thereof;
 FIG. 7 is a perspective view thereof;
 FIG. 8 is a front elevation view of the chair of my ornamental design for a furniture set;
 FIG. 9 is a rear elevation view thereof;
 FIG. 10 is a top plan view thereof;
 FIG. 11 is a bottom plan view thereof;
 FIG. 12 is a left-side view thereof;
 FIG. 13 is a right-side view thereof;
 FIG. 14 is a perspective view thereof;
 FIG. 15 is a front elevation view of the couch of my ornamental design for a furniture set;
 FIG. 16 is a rear elevation view thereof;
 FIG. 17 is a top plan view thereof;
 FIG. 18 is a bottom plan view thereof;
 FIG. 19 is a left-side view thereof;
 FIG. 20 is a right-side view thereof; and,
 FIG. 21 is a perspective view thereof.
 The claimed design is directed to the collective appearance of the table, chair, and couch of the furniture set.

1 Claim, 9 Drawing Sheets

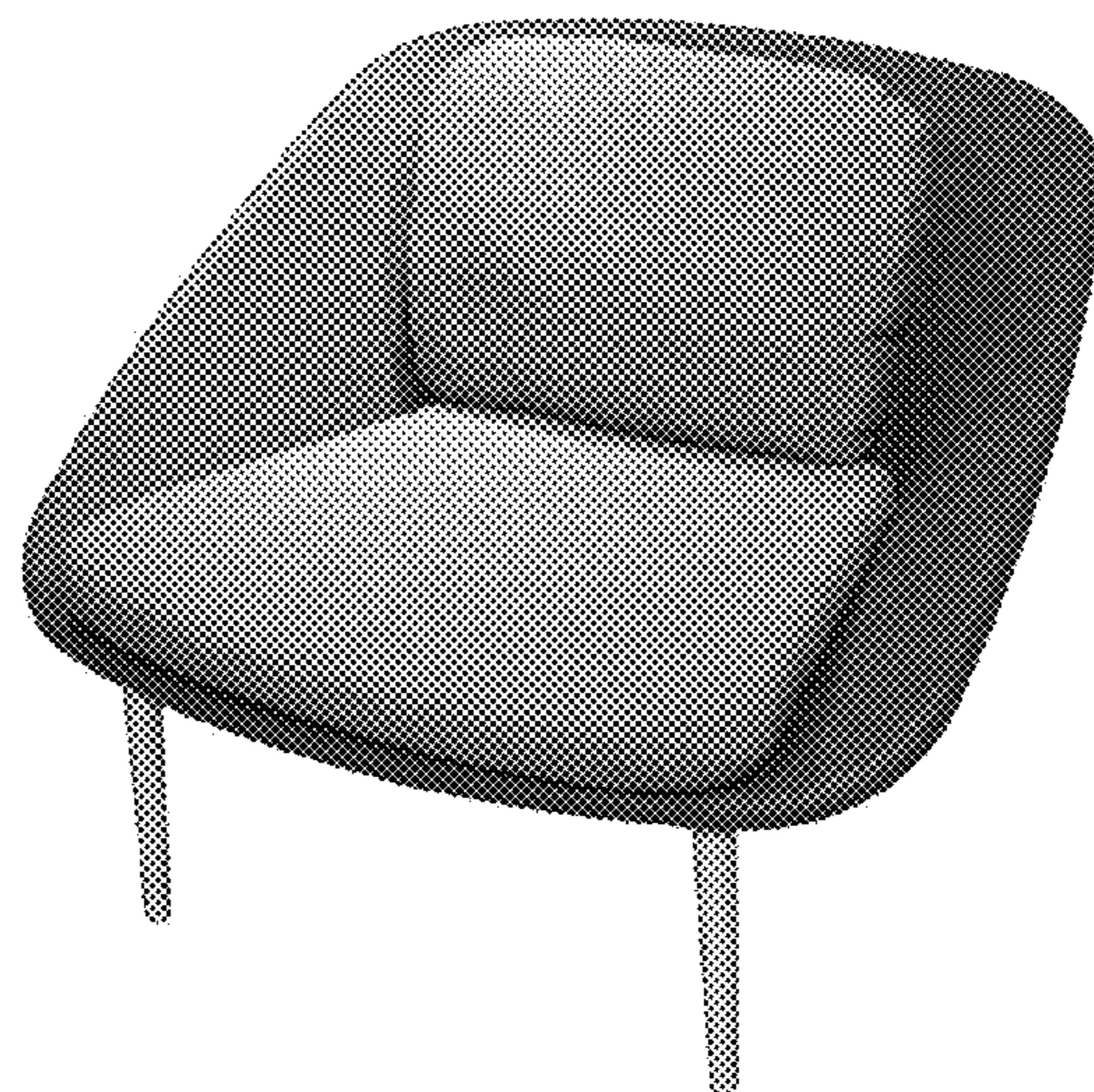

(56)

References Cited

U.S. PATENT DOCUMENTS

D562,583	S	2/2008	Lowsky	
D585,206	S *	1/2009	Mourgue	D6/373
D672,573	S *	12/2012	Bouroullec	D6/381
D675,453	S	2/2013	Blet et al.	
D702,451	S *	4/2014	Hayon	D6/375
D730,074	S *	5/2015	Lievore	D6/373
D736,008	S *	8/2015	Bosman	D6/375
D740,583	S *	10/2015	Nigro	D6/375
D758,752	S	6/2016	Garcia	
D759,393	S *	6/2016	Hayon	D6/334
D771,402	S	11/2016	Woller	
D771,421	S	11/2016	Garcia	
D773,218	S	12/2016	Everson et al.	
D773,868	S	12/2016	Schwalbach et al.	
D785,955	S *	5/2017	Jourdan	D6/334

* cited by examiner

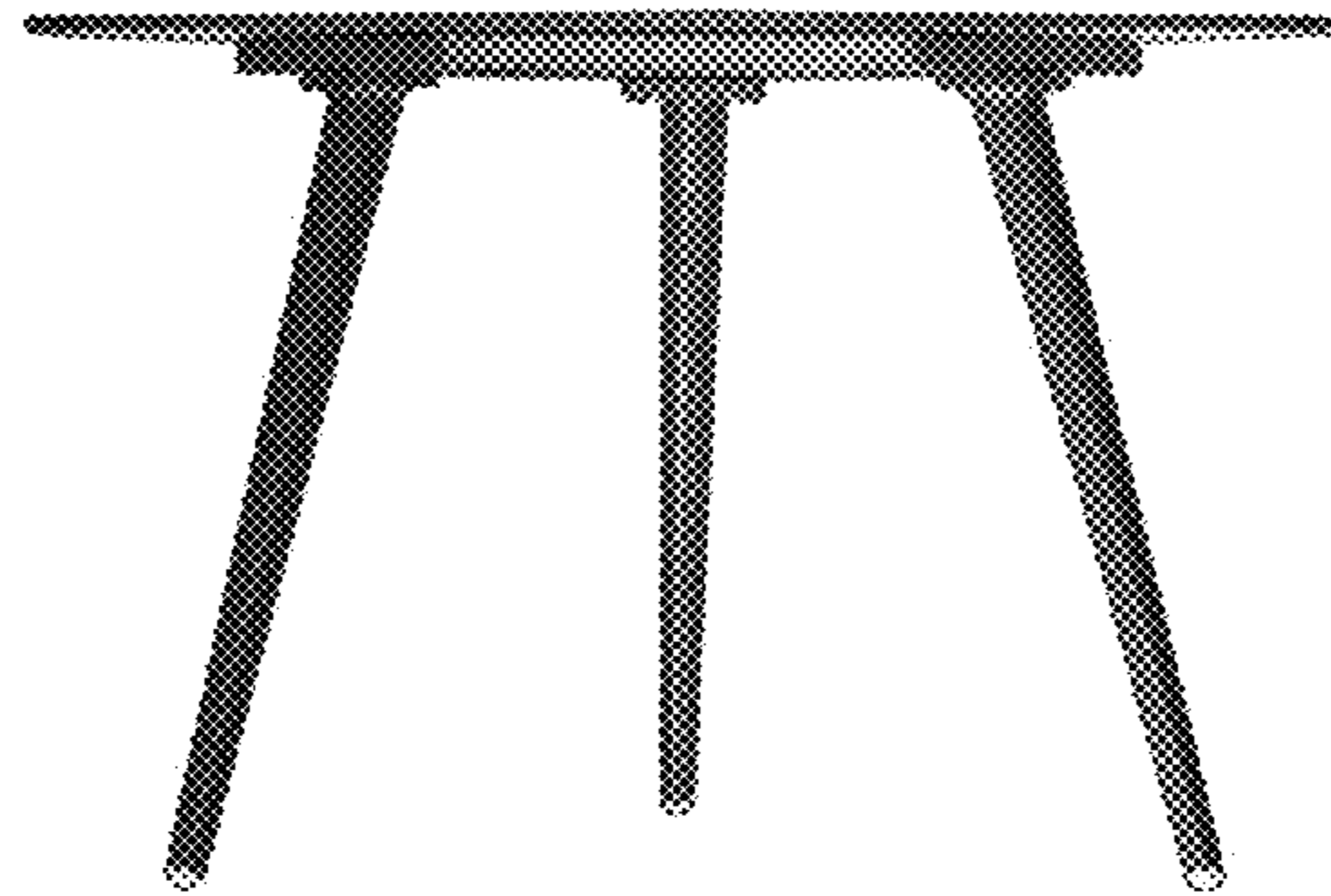

Fig. 1

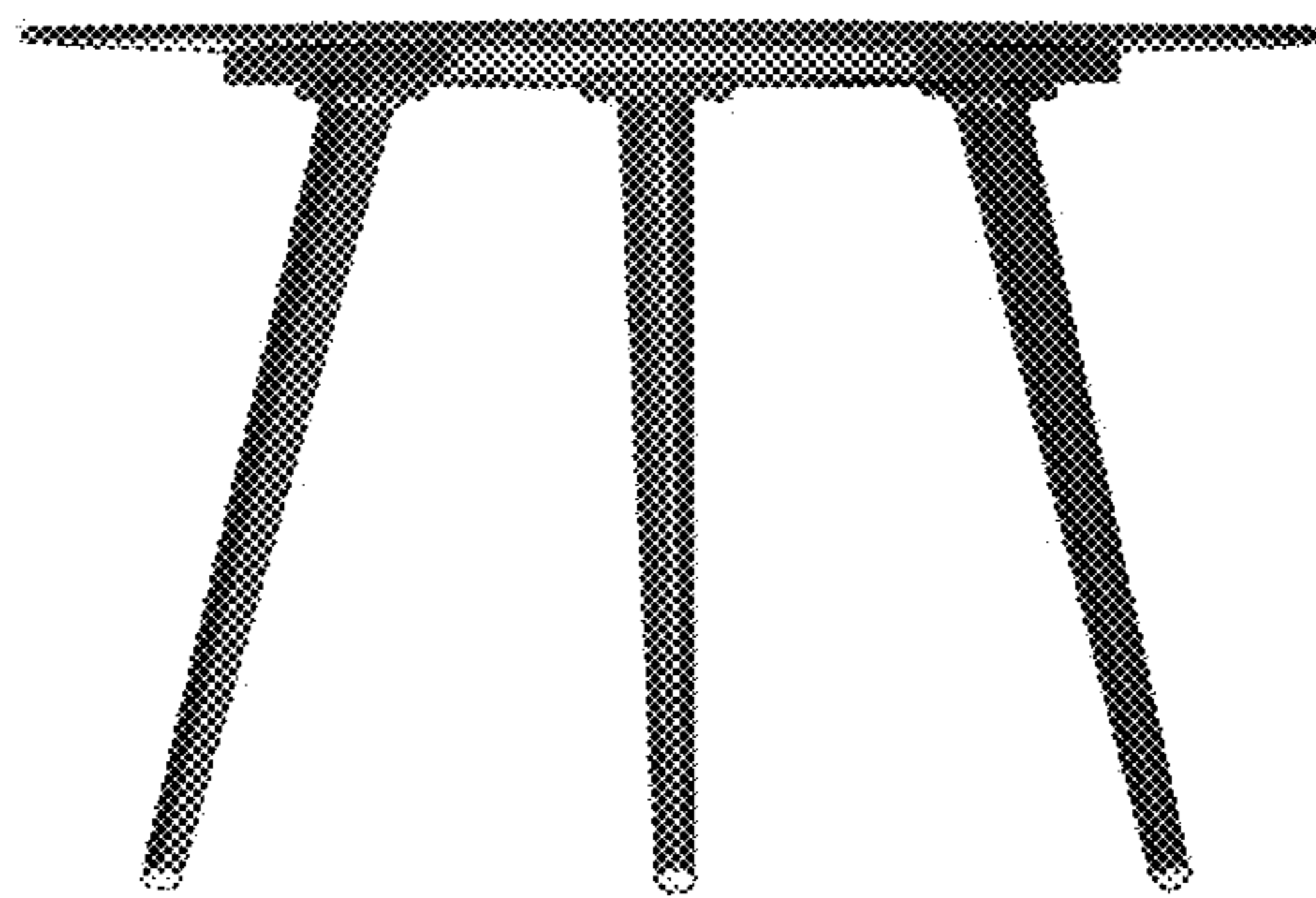

Fig. 2

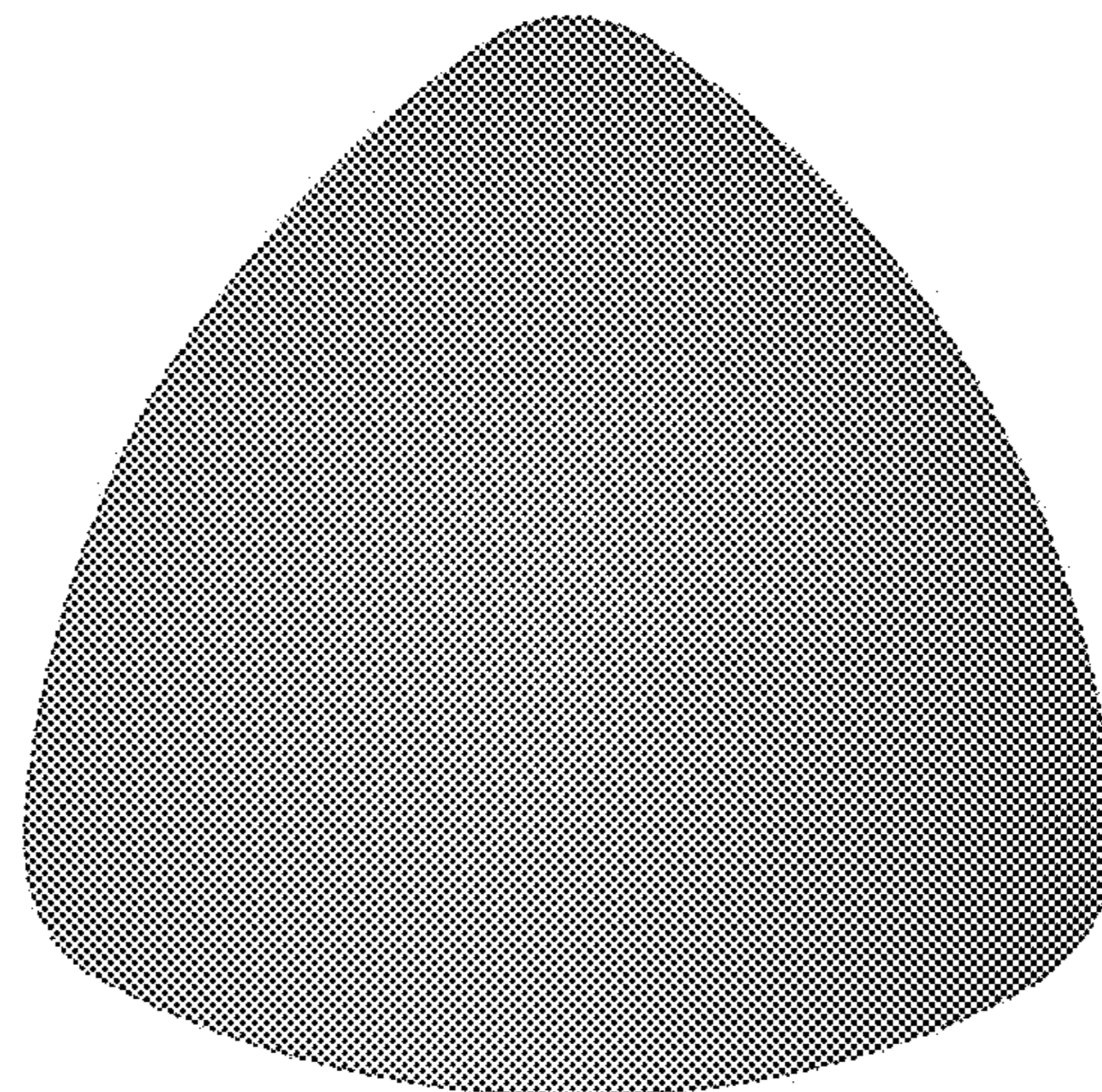

Fig. 3

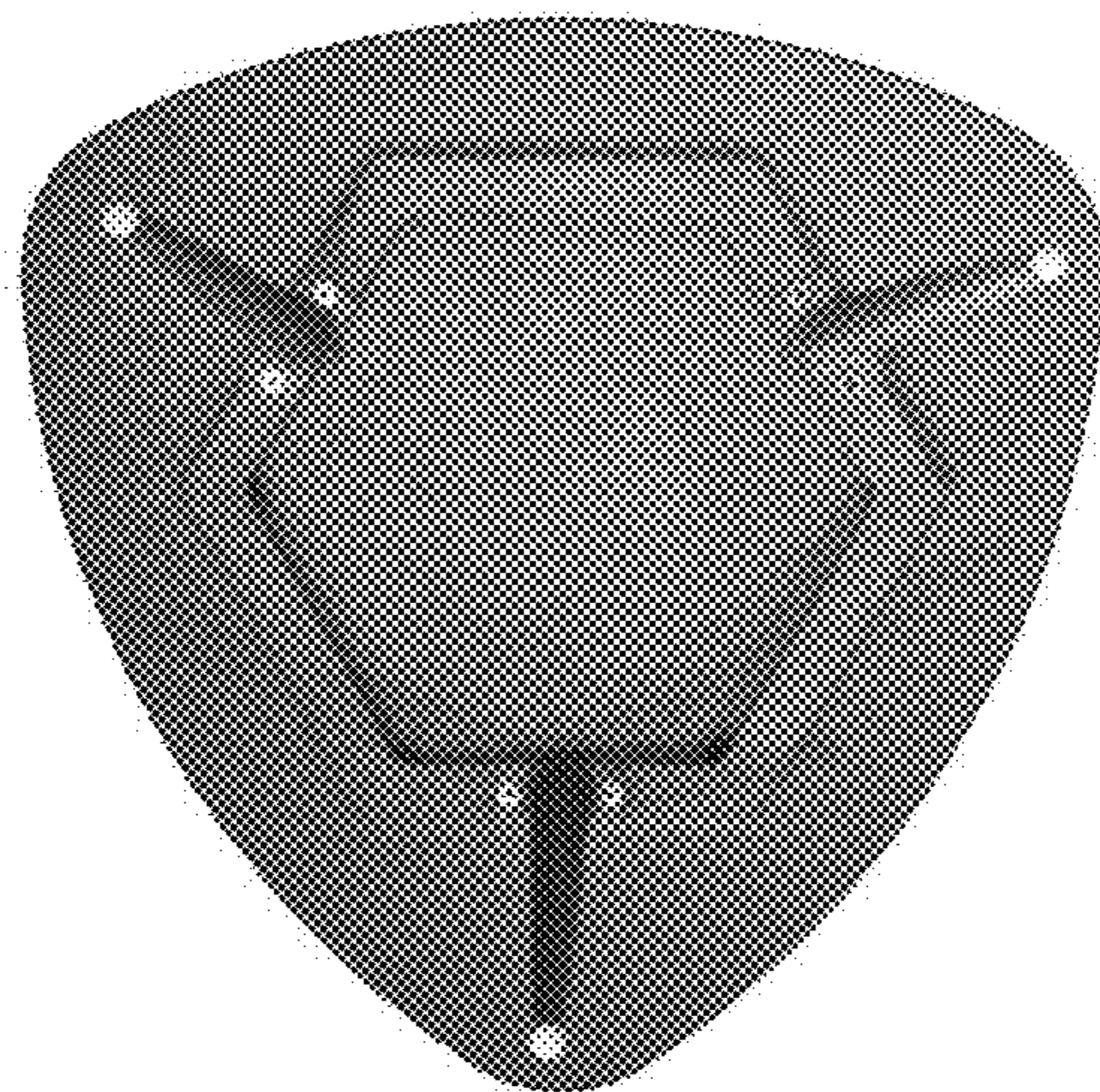

Fig. 4

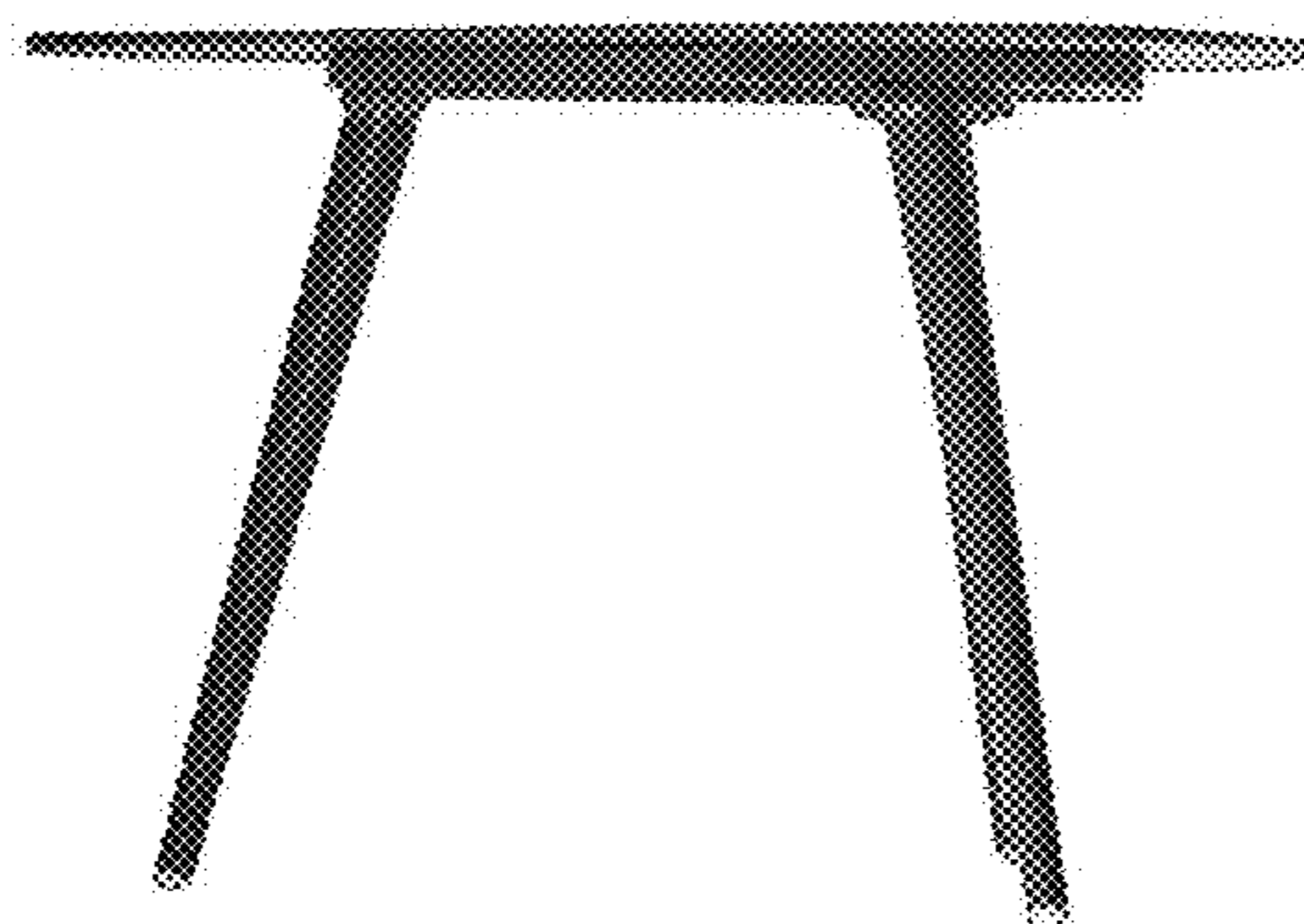

Fig. 5

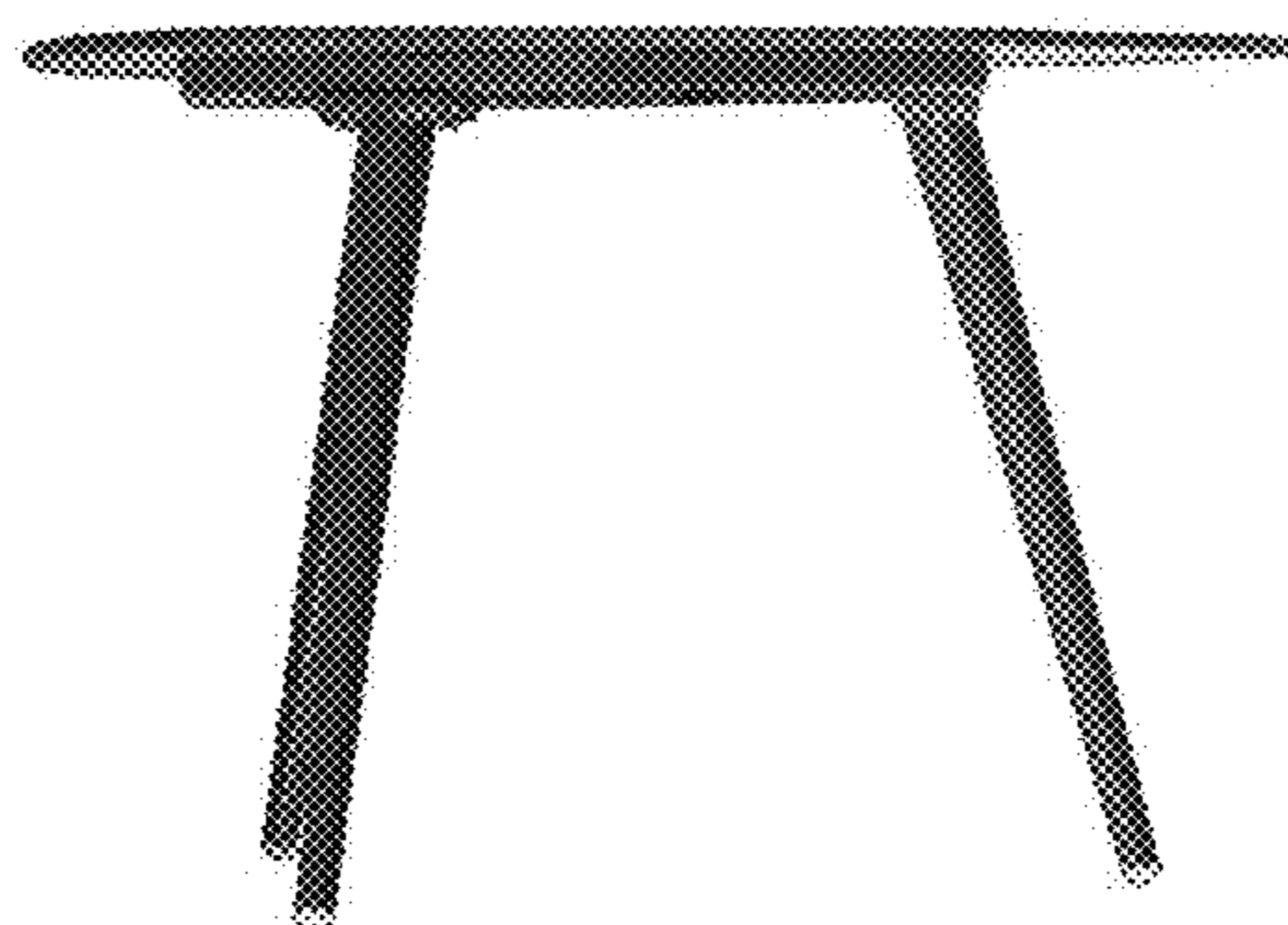

Fig. 6



Fig. 7



Fig. 8

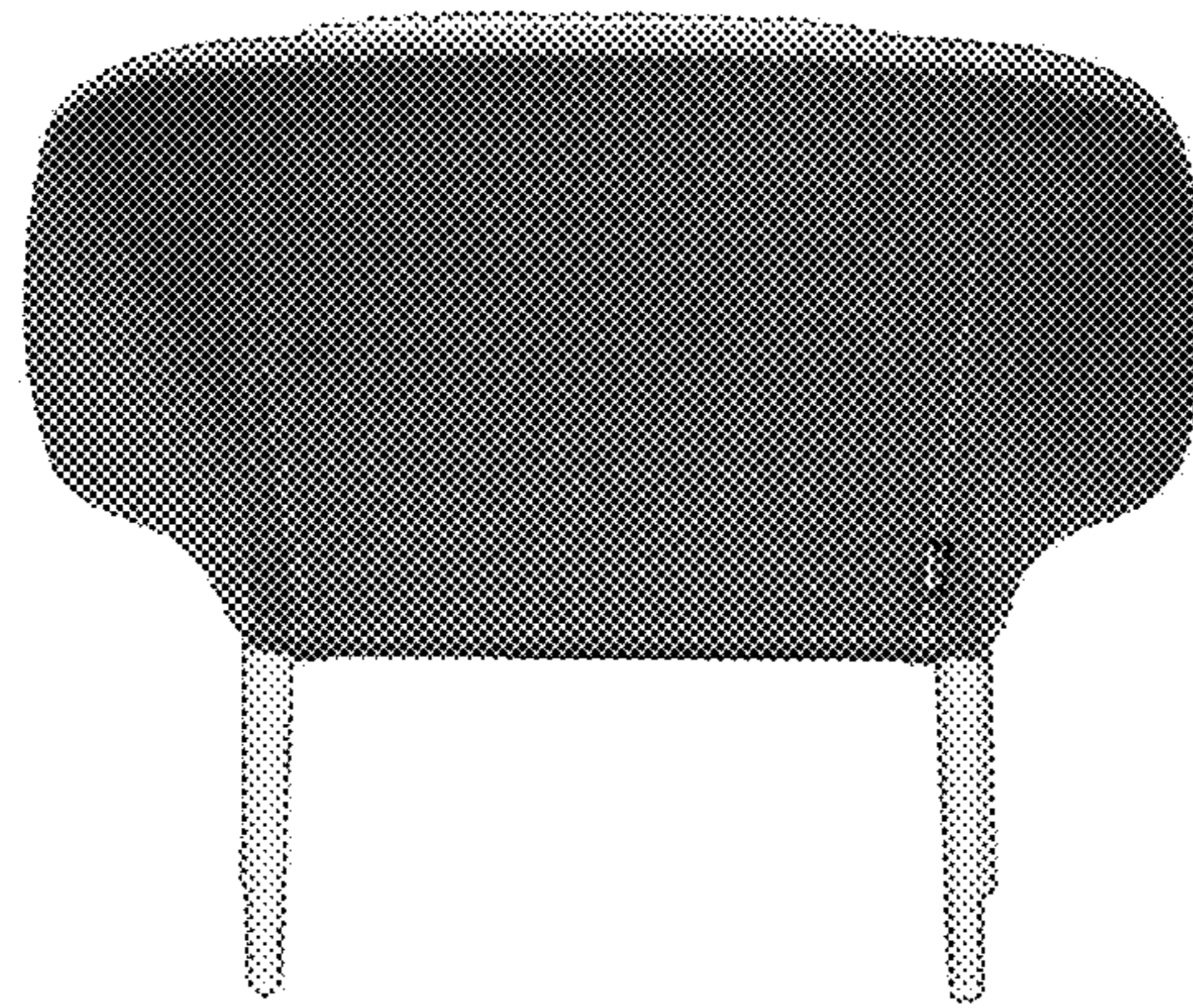

Fig. 9

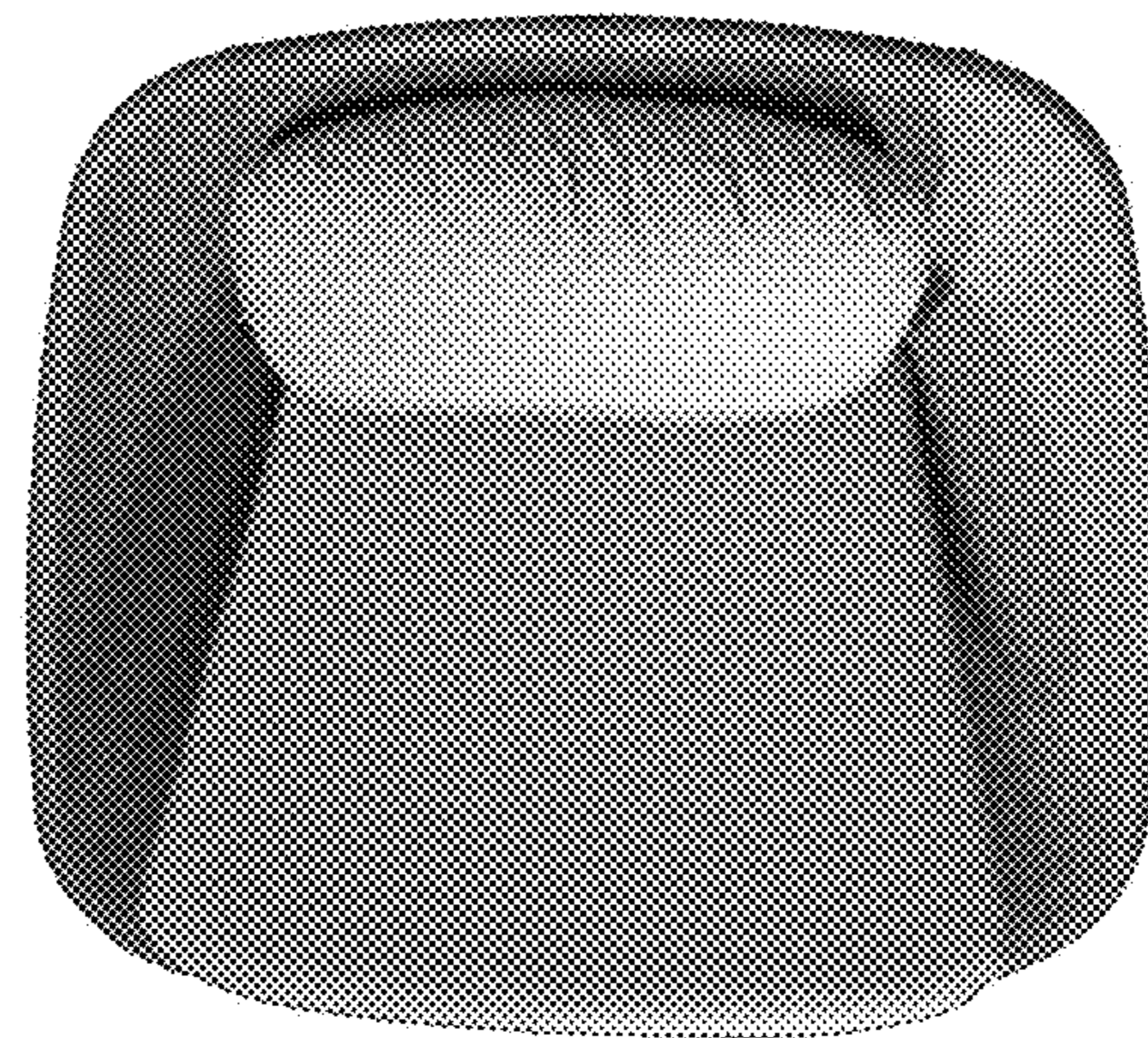

Fig. 10

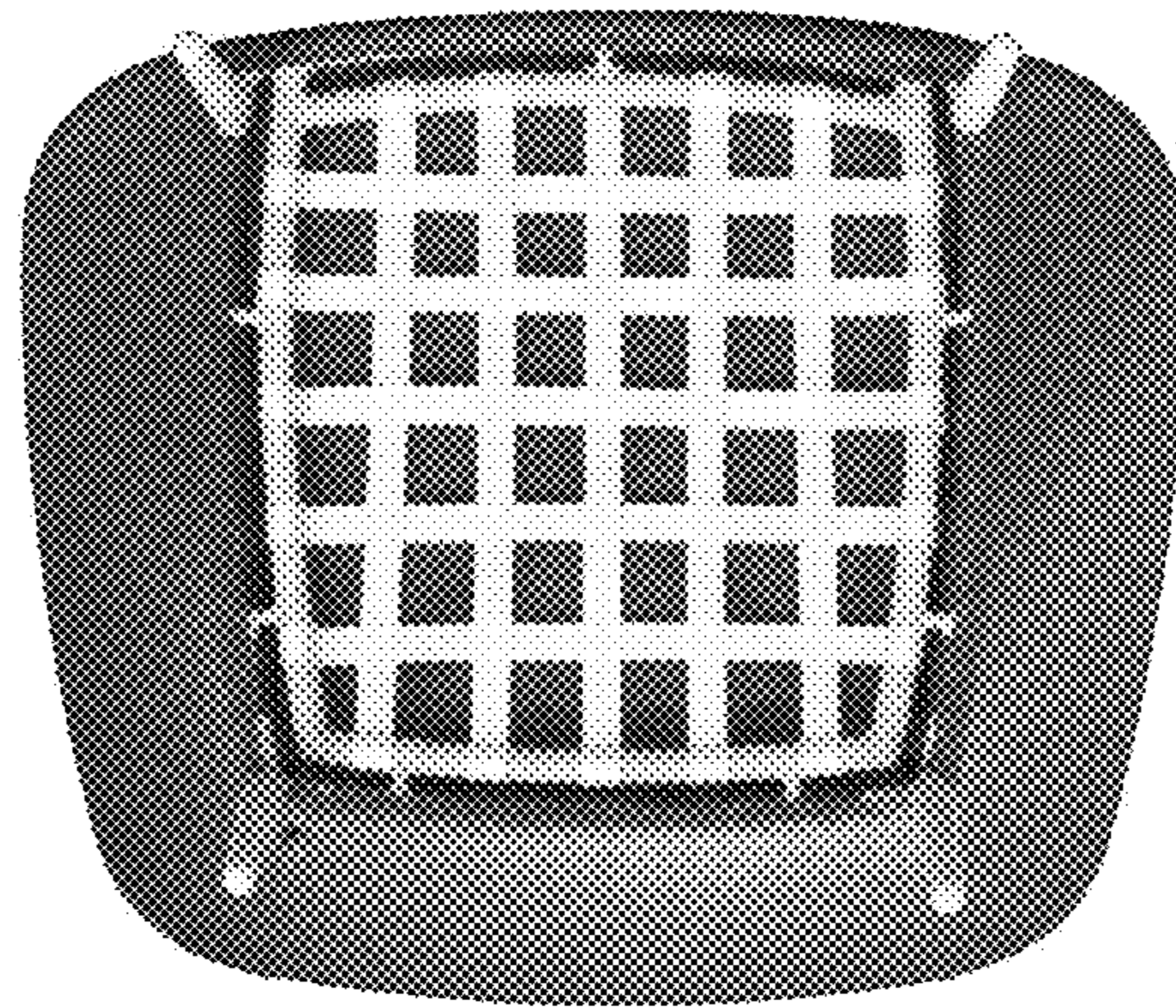

Fig. 11

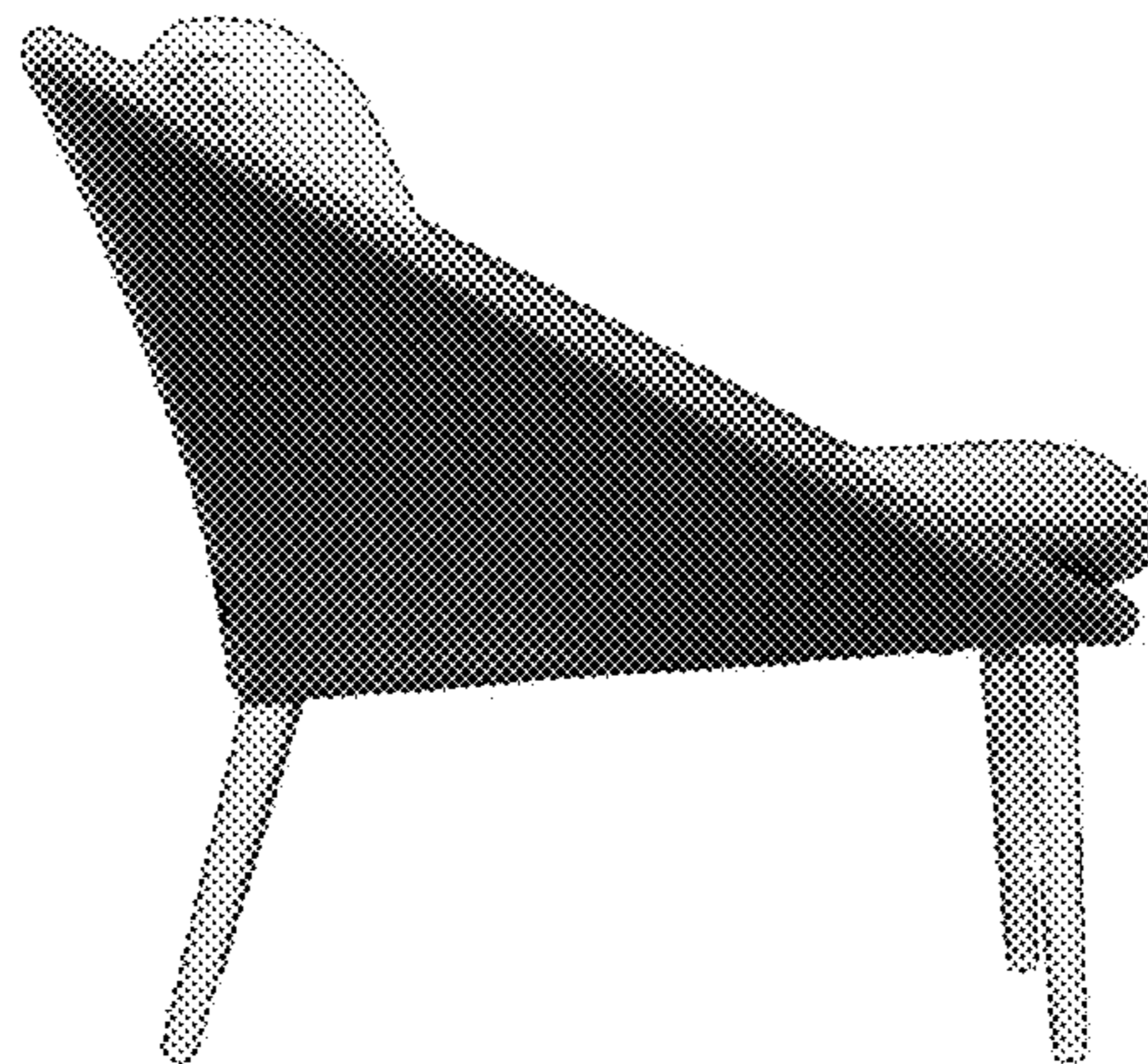

Fig. 12

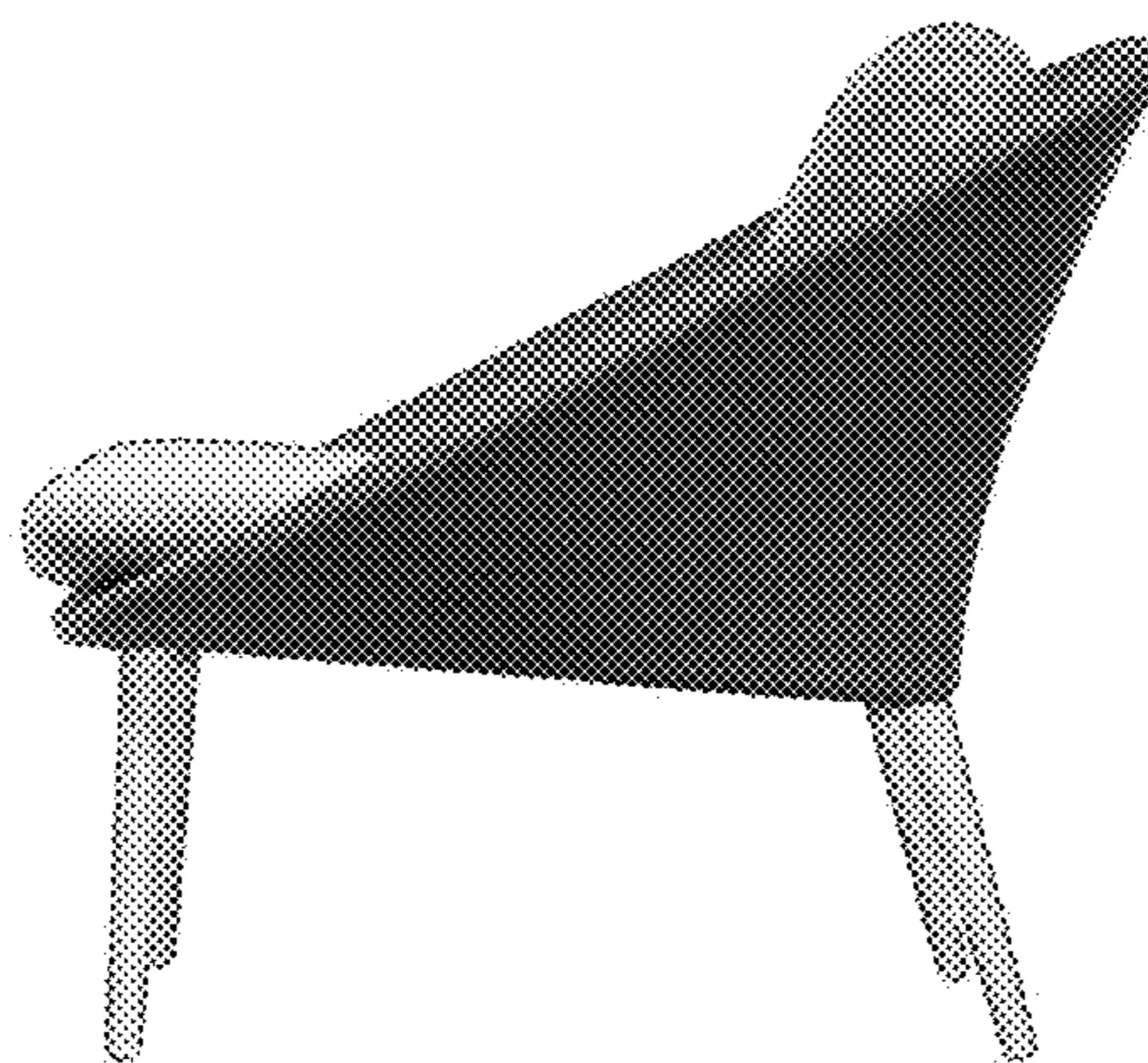

Fig. 13



Fig. 14

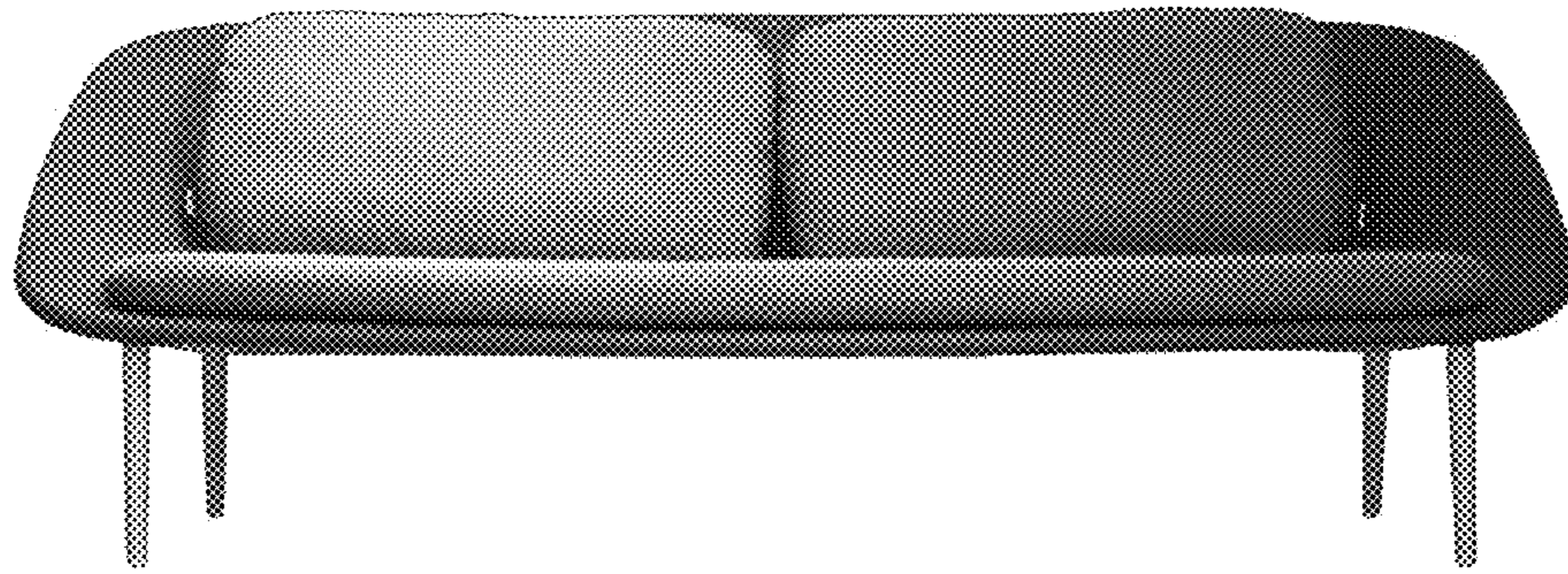

Fig. 15

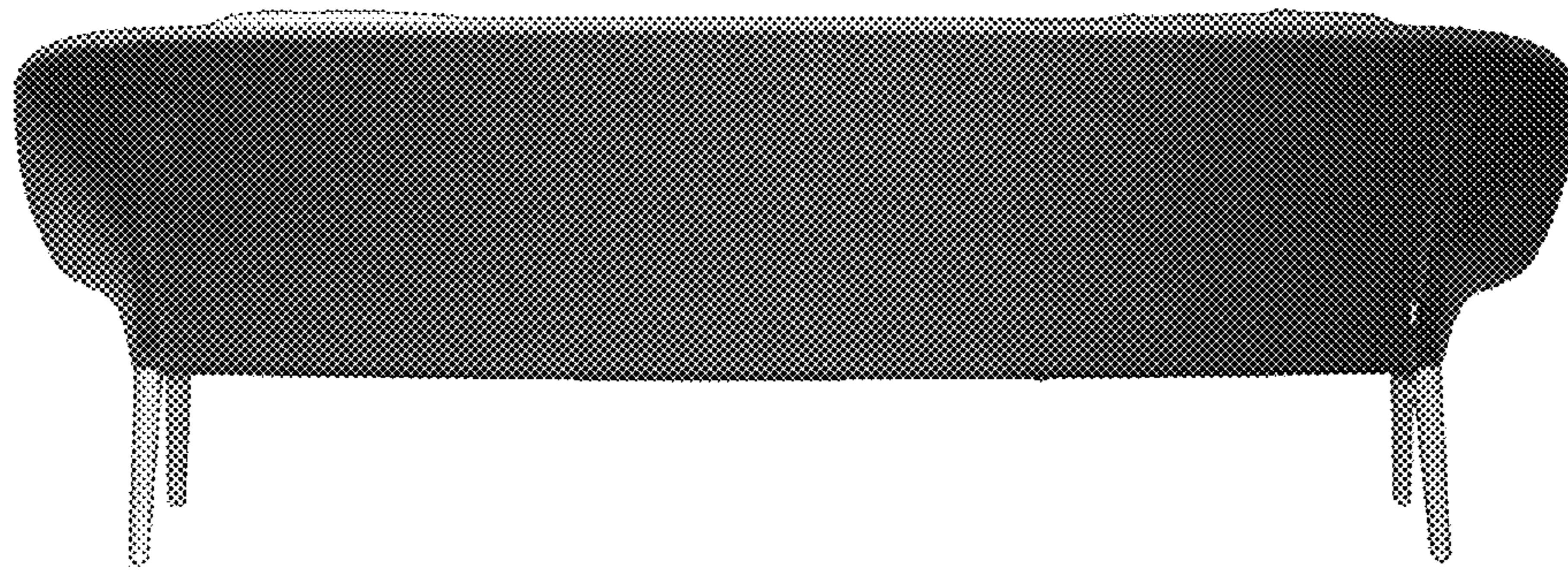

Fig. 16

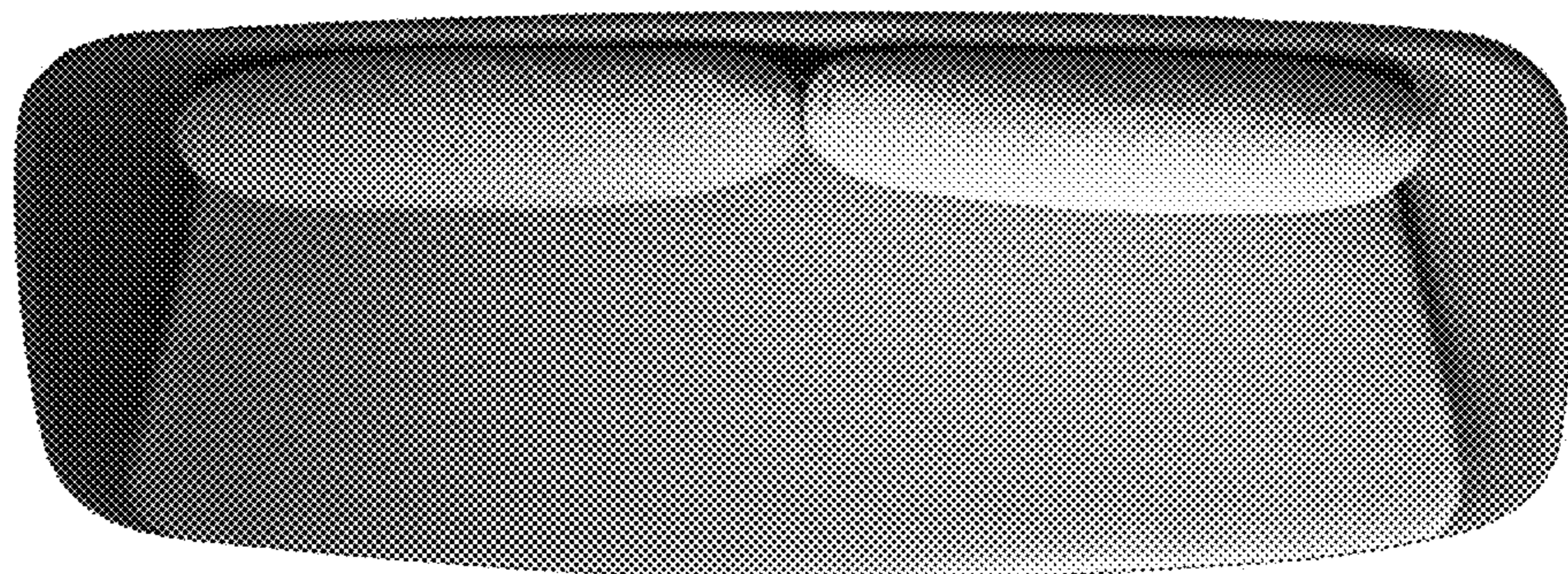

Fig. 17

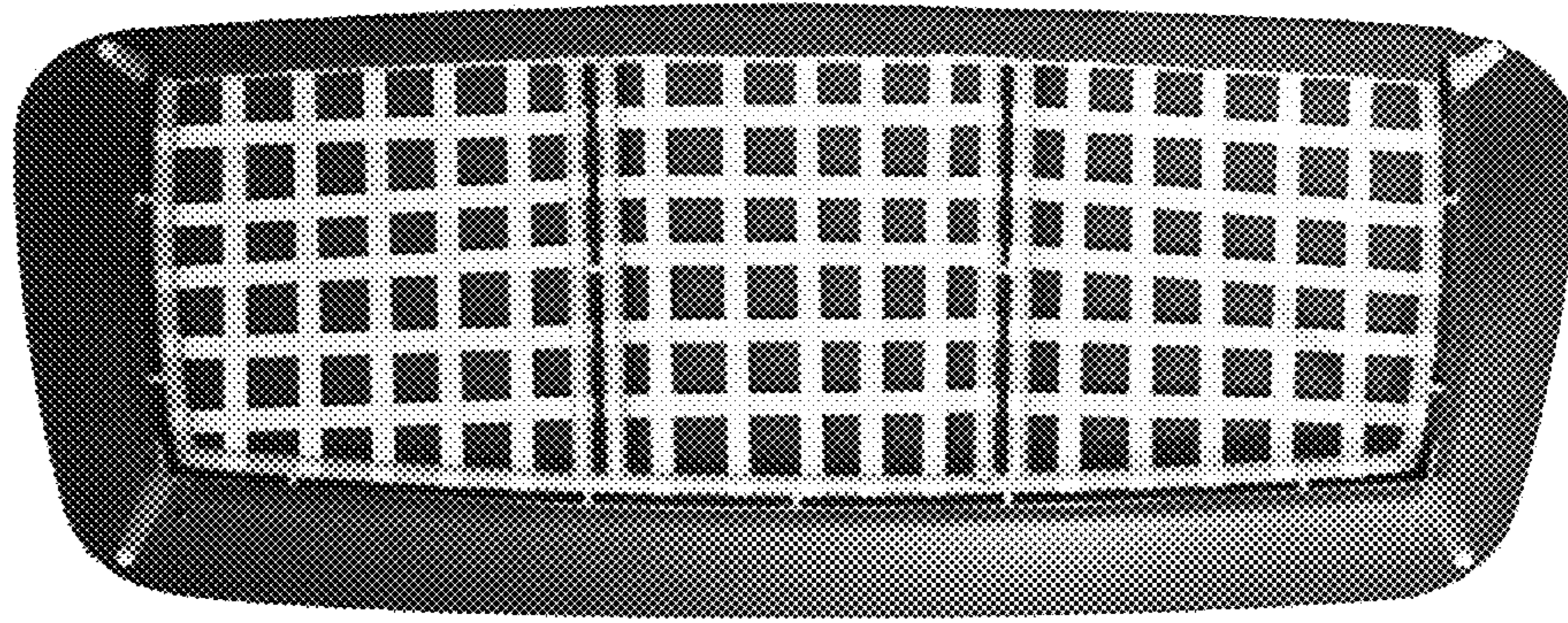

Fig. 18

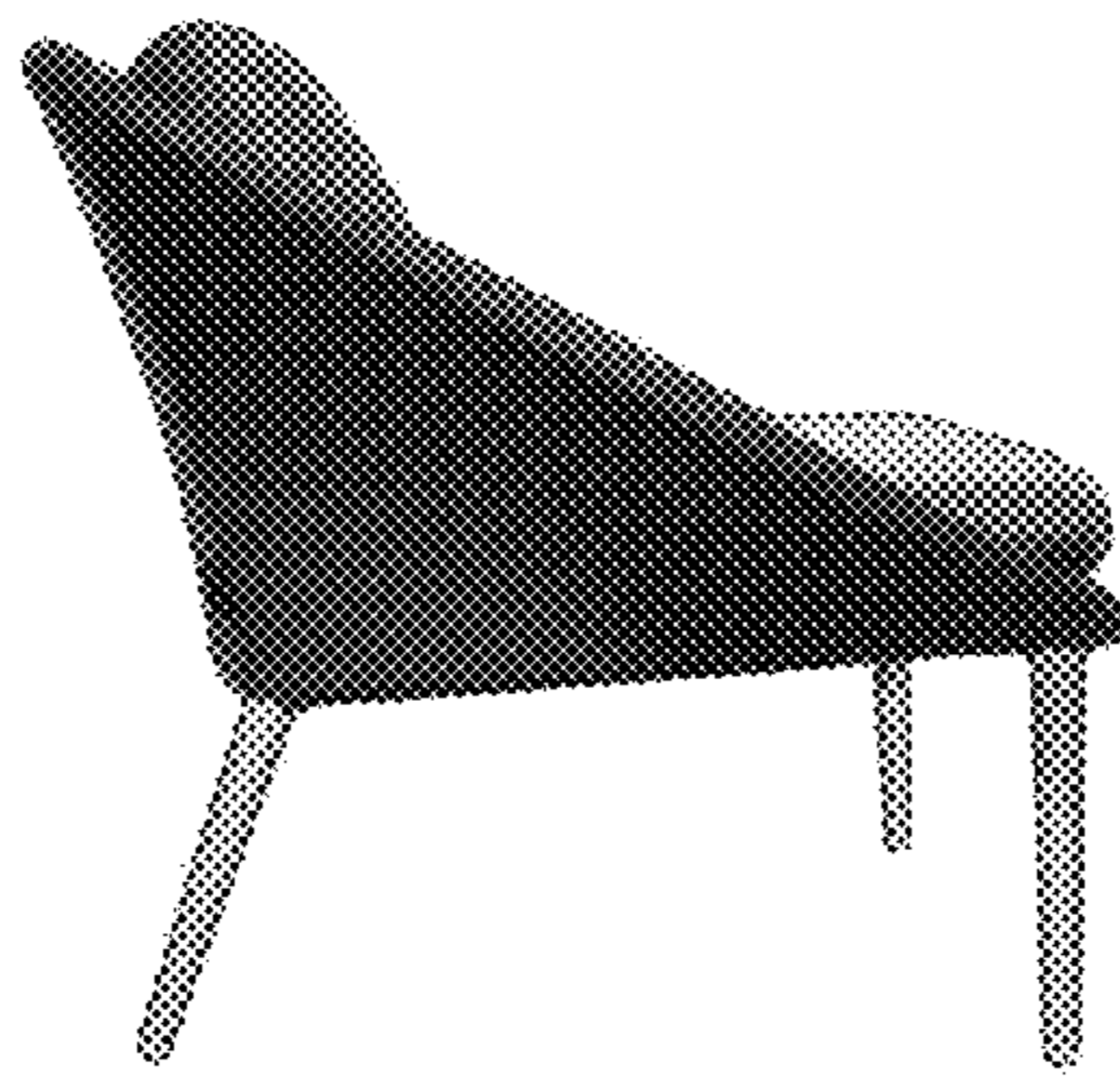

Fig. 19

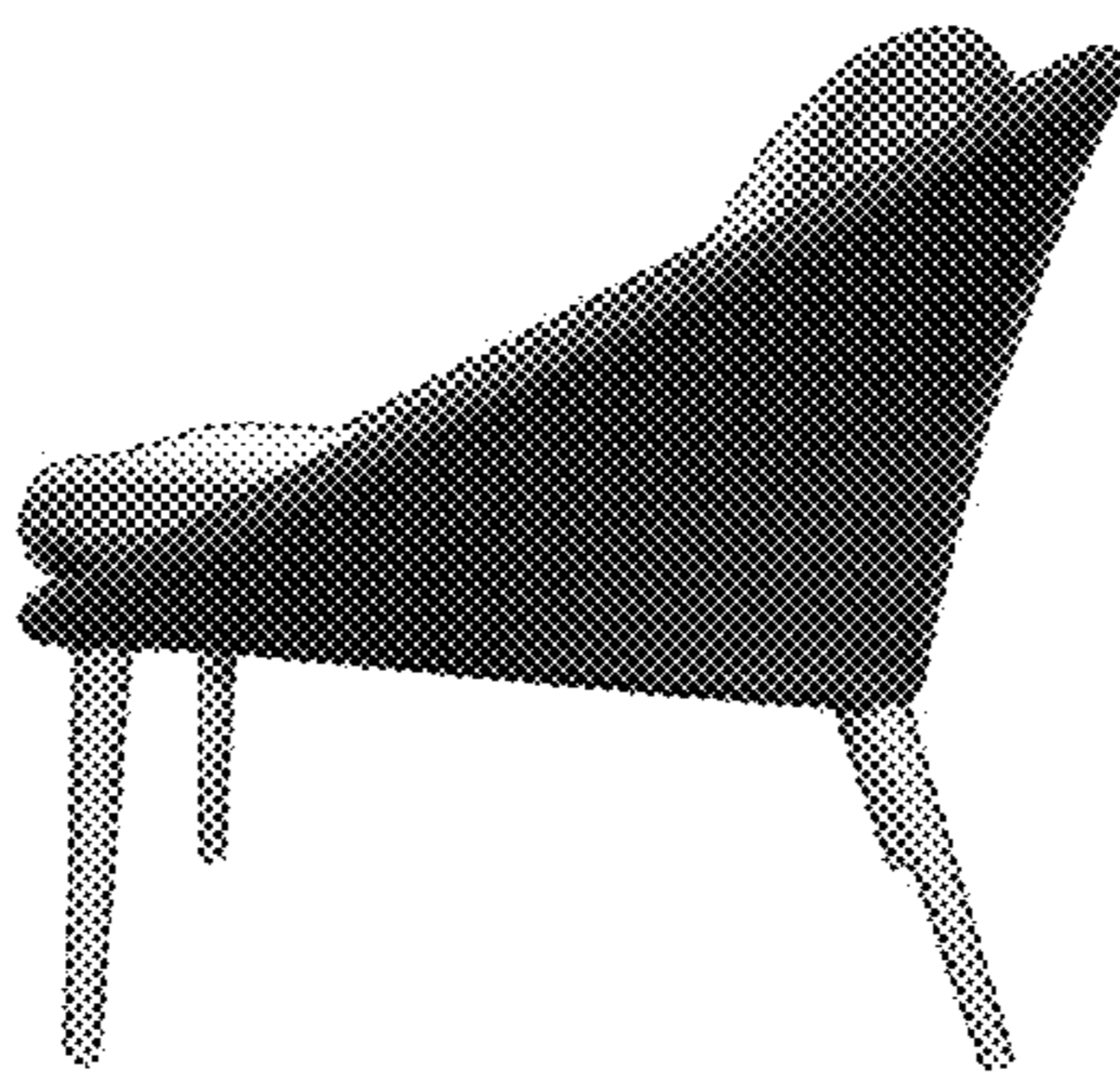

Fig. 20



Fig. 21