



US00D811099S

(12) **United States Design Patent**
Marchand et al.

(10) **Patent No.:** **US D811,099 S**
(45) **Date of Patent:** **** Feb. 27, 2018**

(54) **BASE FOR SUPPORTING ARTWORK**

DESCRIPTION

(71) Applicants: **Marie-Claude Marchand**, Montreal (CA); **Nancy Lahaie**, Laval (CA)

(72) Inventors: **Marie-Claude Marchand**, Montreal (CA); **Nancy Lahaie**, Laval (CA)

(**) Term: **15 Years**

(21) Appl. No.: **29/566,672**

(22) Filed: **Jun. 1, 2016**

(51) **LOC (11) Cl.** **06-07**

(52) **U.S. Cl.**
USPC **D6/310; D6/675**

(58) **Field of Classification Search**
USPC D6/300-314, 682, 682.1, 675, 708.17, D6/708.21; D19/86, 90, 91, 96, 34.1; D20/42-44; D9/432; D21/491
CPC G09F 15/00; G09F 15/0012; G09F 7/18; G09F 1/10; Y10S 248/91; A47G 1/06; A47G 2001/0661; A47G 2001/0688; A47G 2001/145

See application file for complete search history.

(56) **References Cited**

U.S. PATENT DOCUMENTS

- 1,152,461 A * 9/1915 Wright G09F 1/14 248/473
- 1,415,110 A * 5/1922 Pearl B42F 17/02 211/11
- D95,588 S * 5/1935 Holsman D20/10
- D101,143 S * 9/1936 Shank 211/50
- D139,166 S * 10/1944 Cushman D6/314

(Continued)

Primary Examiner — Deanna L Pratt

(57) **CLAIM**

The ornamental design for a “base for supporting artwork”, as shown.

FIG. 1 is a perspective view of a base for supporting artwork incorporating a design according to the invention;
 FIG. 2 is a rear elevational view thereof;
 FIG. 3 is a front elevational view thereof;
 FIG. 4 is a left side elevational view thereof;
 FIG. 5 is a right side elevational view thereof;
 FIG. 6 is a top plan view thereof;
 FIG. 7 is a bottom plan view thereof;
 FIG. 8 is a perspective environmental view thereof showing the base supporting artwork, the artwork being unclaimed and shown in phantom lines;
 FIG. 9 is a perspective view of the base for supporting artwork incorporating another design according to the invention;
 FIG. 10 is a rear elevational view thereof;
 FIG. 11 is a front elevational view thereof;
 FIG. 12 is a left side elevational view thereof;
 FIG. 13 is a right side elevational view thereof;
 FIG. 14 is a top plan view thereof;
 FIG. 15 is a bottom plan view thereof;
 FIG. 16 is a perspective environmental view thereof showing the base supporting artwork, the artwork being unclaimed and shown in phantom lines;
 FIG. 17 is a perspective view of the base for supporting artwork incorporating yet another design according to the invention;
 FIG. 18 is a rear elevational view thereof;
 FIG. 19 is a front elevational view thereof;
 FIG. 20 is a left side elevational view thereof;
 FIG. 21 is a right side elevational view thereof;
 FIG. 22 is a top plan view thereof;
 FIG. 23 is a bottom plan view thereof; and,
 FIG. 24 is a perspective environmental view thereof showing the base supporting artwork, the artwork being unclaimed and shown in phantom lines.

The features shown in phantom lines in the drawings depict environmental subject matter and form no part of the claimed design.

1 Claim, 17 Drawing Sheets

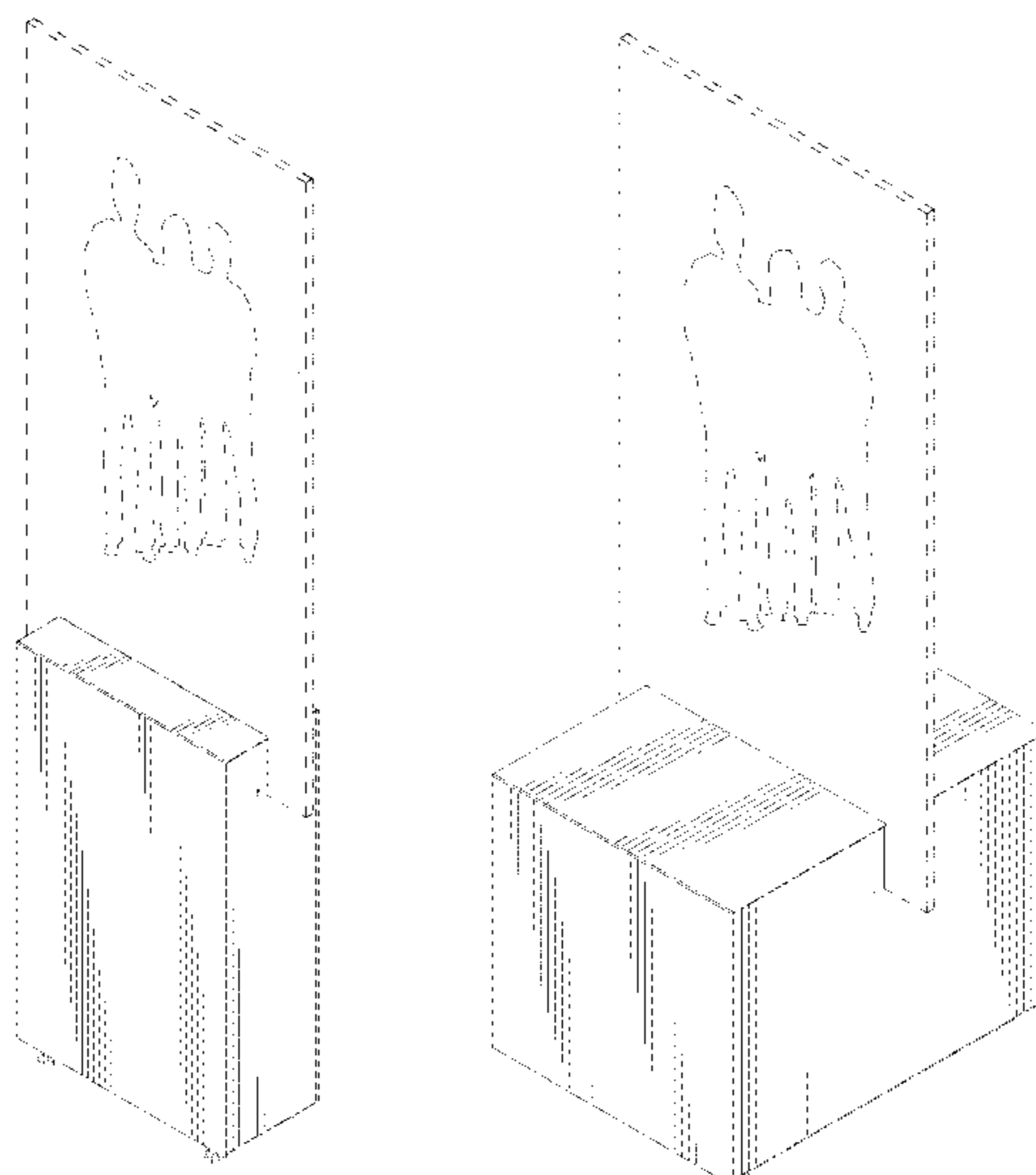

(56)

References Cited

U.S. PATENT DOCUMENTS

D149,202 S * 4/1948 Maugham D6/314
2,557,399 A * 6/1951 Teetor G09F 1/14
116/63 P
3,557,965 A * 1/1971 Agerholm A47B 63/00
211/11
4,125,243 A * 11/1978 Liptak A47F 7/142
248/205.3
D349,925 S * 8/1994 Charron D19/90
D397,270 S * 8/1998 Maalouf 5/636
5,857,654 A * 1/1999 Berman A47B 21/045
248/441.1
D425,730 S * 5/2000 Murphy D6/675
6,412,743 B1 * 7/2002 Fell A47F 5/0815
248/346.03
D465,660 S * 11/2002 Doeing D19/90
D477,920 S * 8/2003 McCarty D6/310
D501,887 S * 2/2005 Lee D19/90
D552,357 S * 10/2007 Fu D10/2
D652,457 S * 1/2012 Robins D21/491
D660,702 S * 5/2012 Malone D9/456
D674,070 S * 1/2013 Barron D23/366
D697,786 S * 1/2014 McMahan D6/310
D702,875 S * 4/2014 Klus D25/122
D716,870 S * 11/2014 Jungst D19/91
D716,928 S * 11/2014 Falduto D23/366
D730,090 S * 5/2015 Christal D6/675.3
D747,582 S * 1/2016 Weller D32/40
D756,211 S * 5/2016 Downs D8/395
9,560,912 B1 * 2/2017 Chin A47B 23/04
2008/0285785 A1 * 11/2008 Zieg H04R 5/023
381/370

* cited by examiner

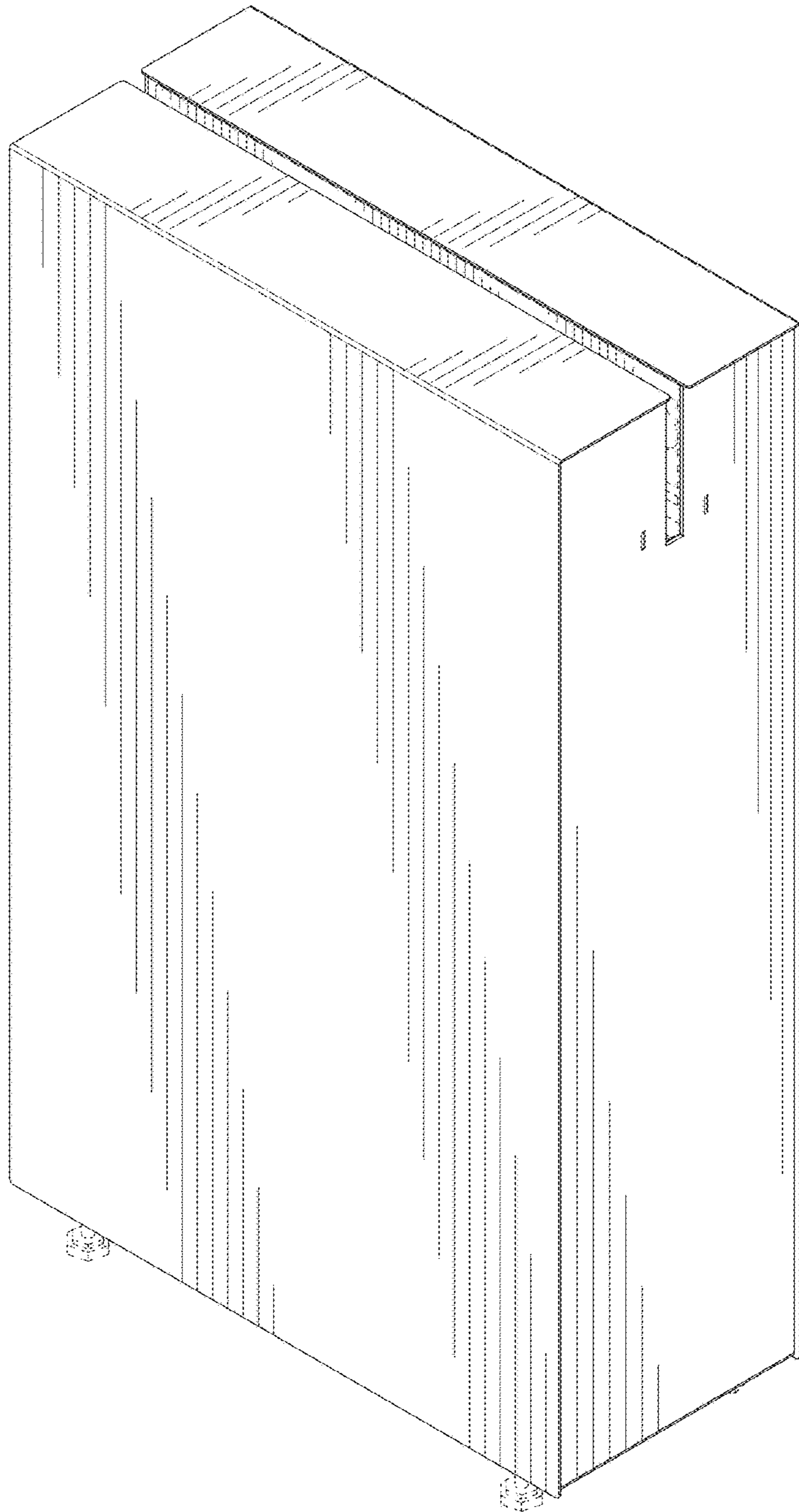

FIG.1

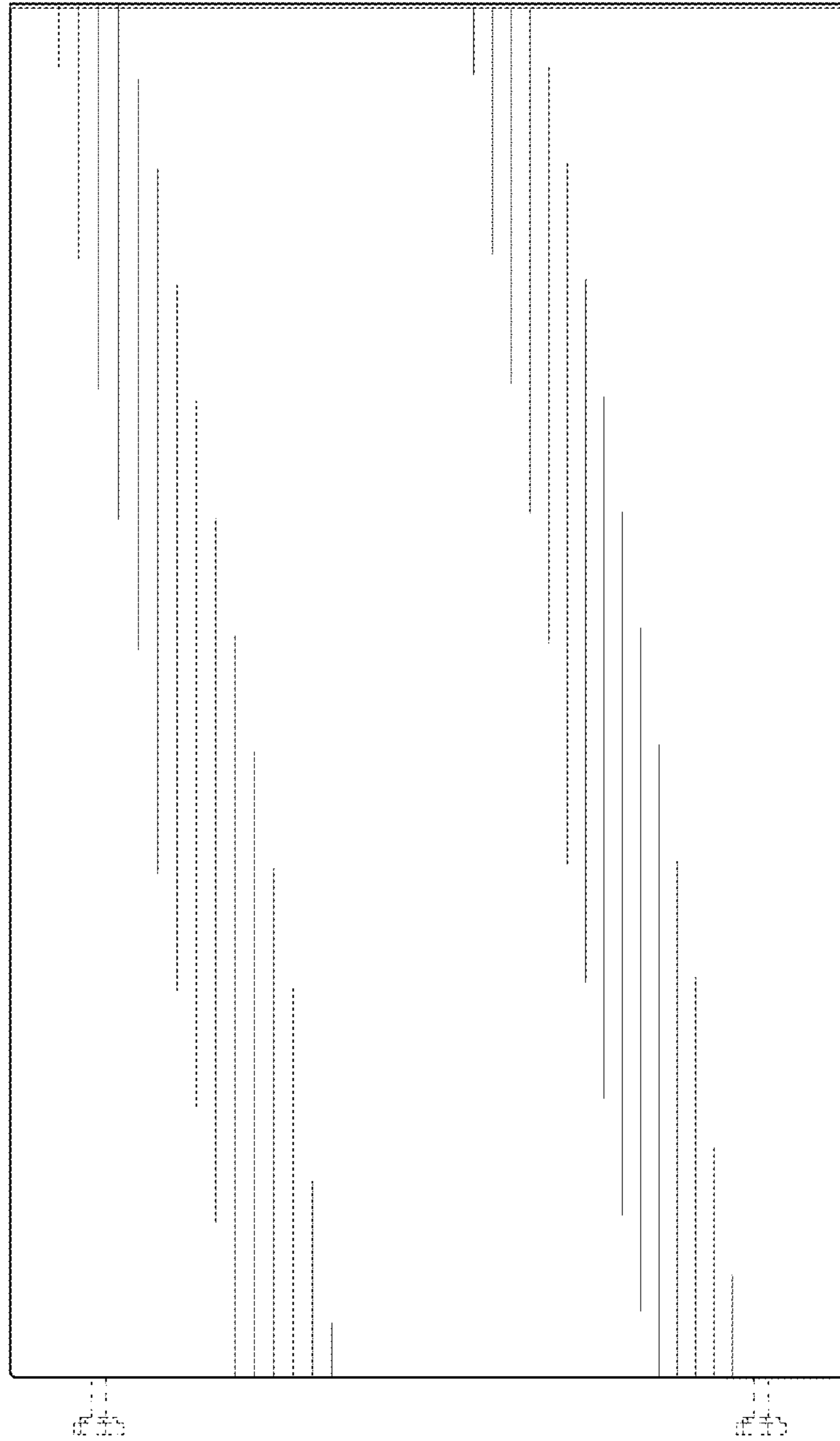

FIG.2

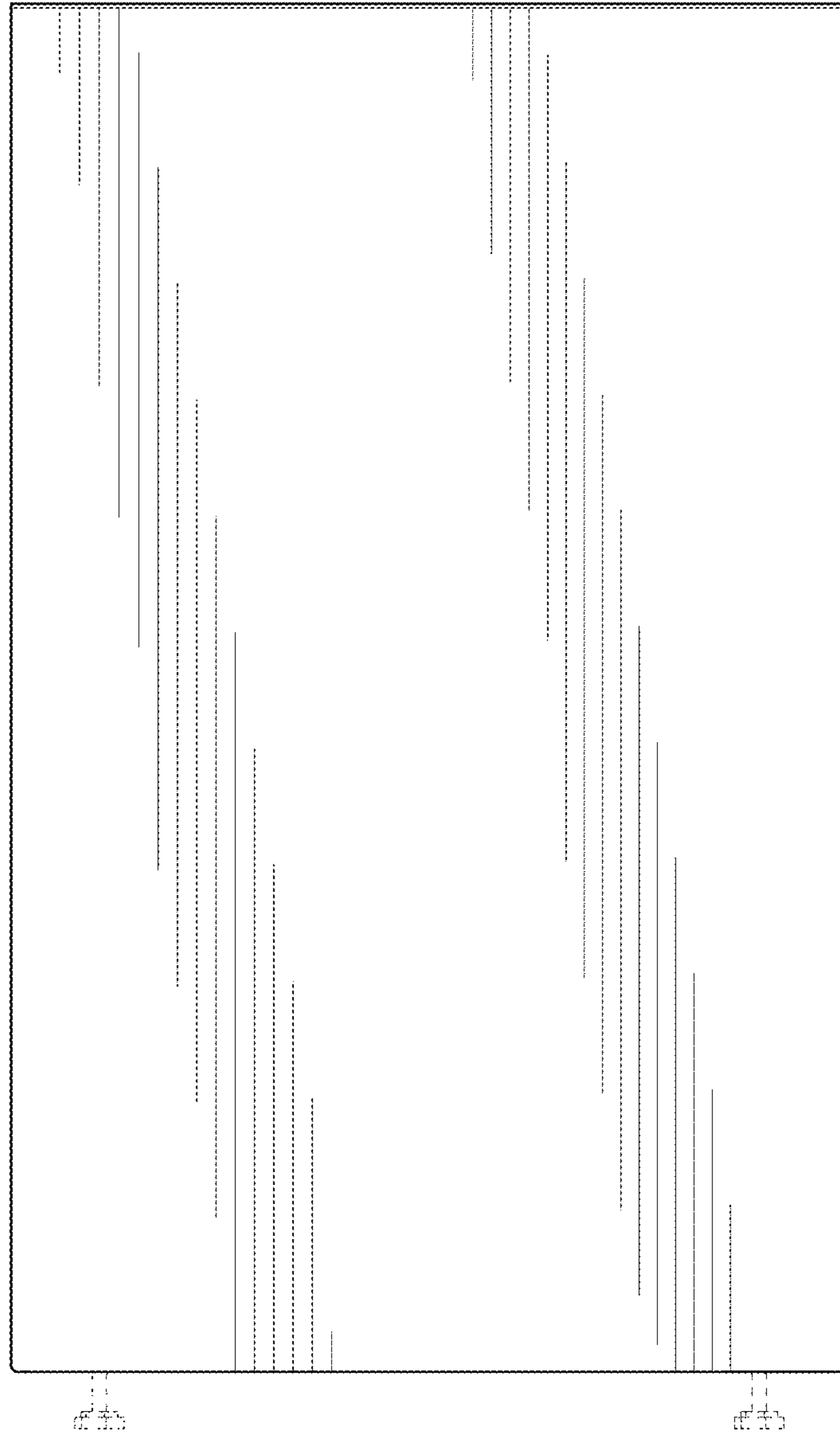

FIG.3

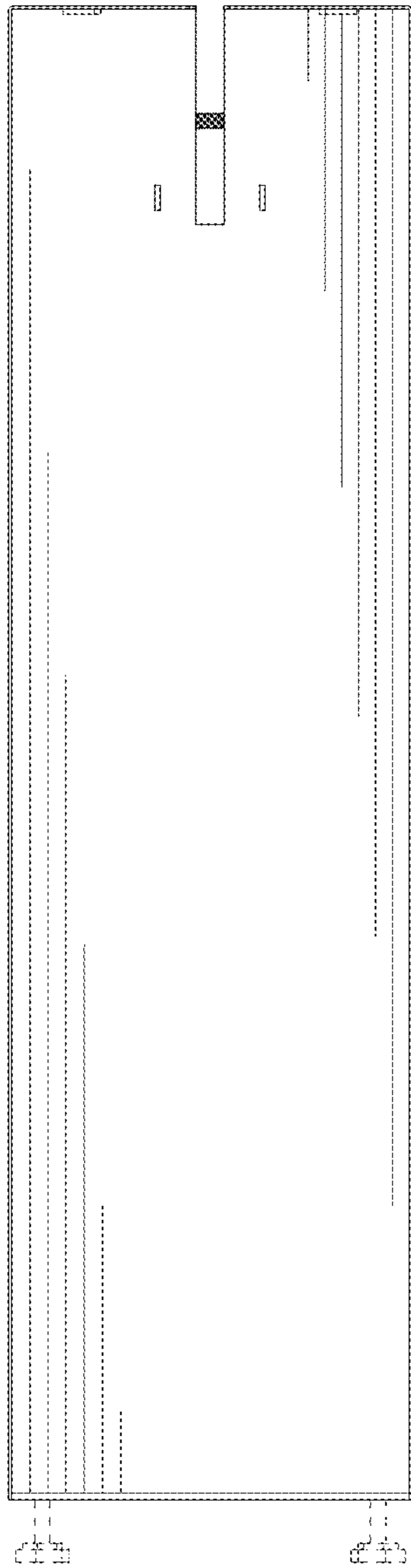

FIG. 4

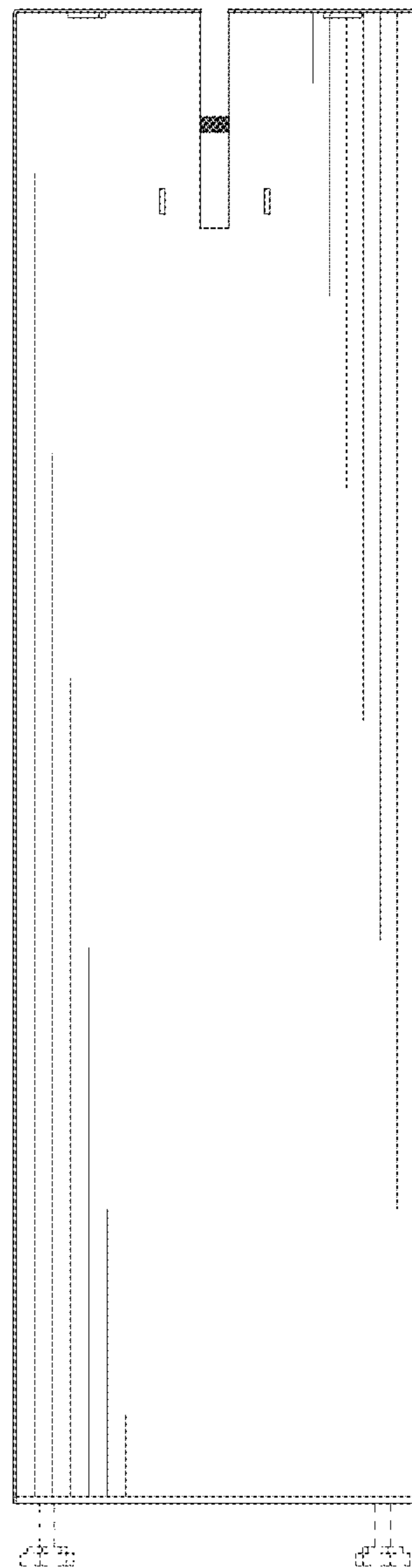

FIG. 5

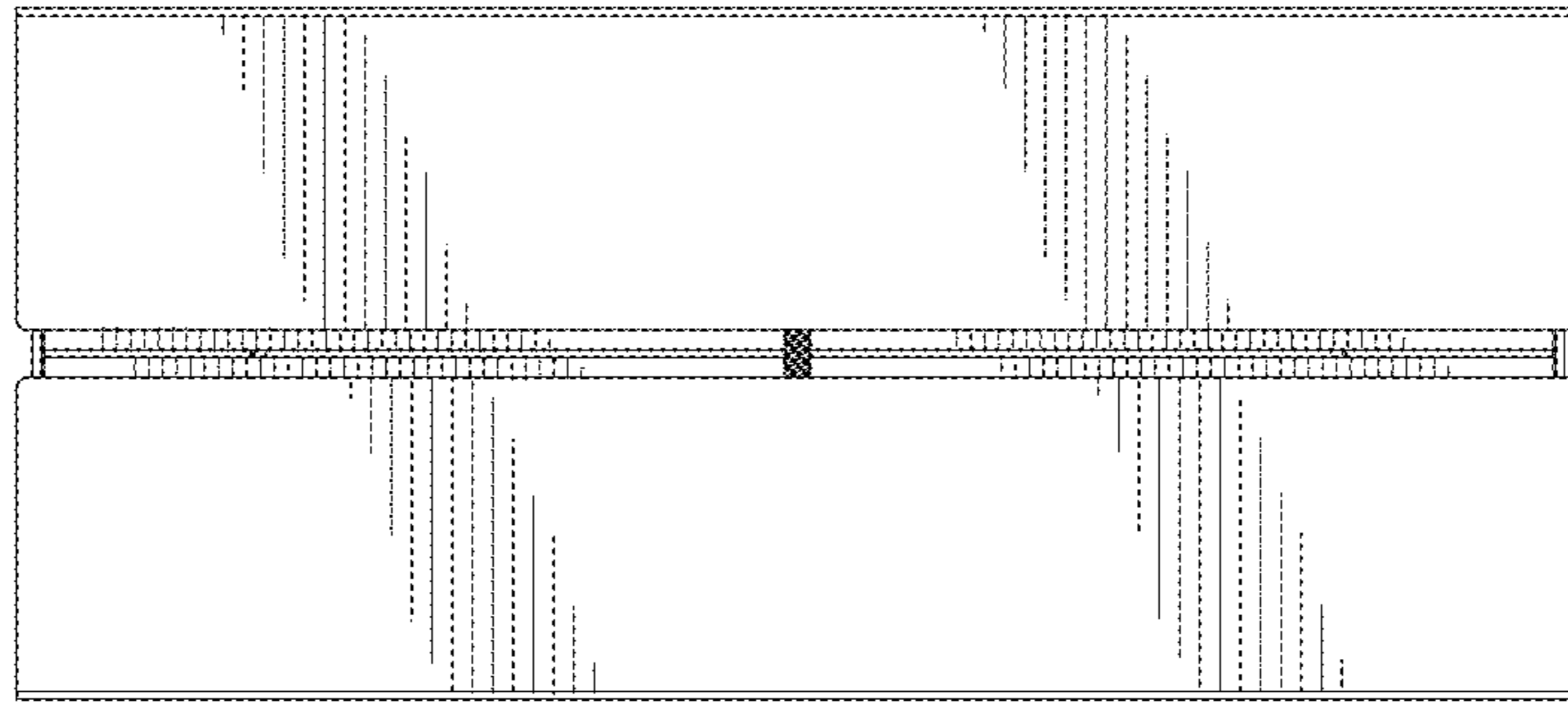

FIG. 6

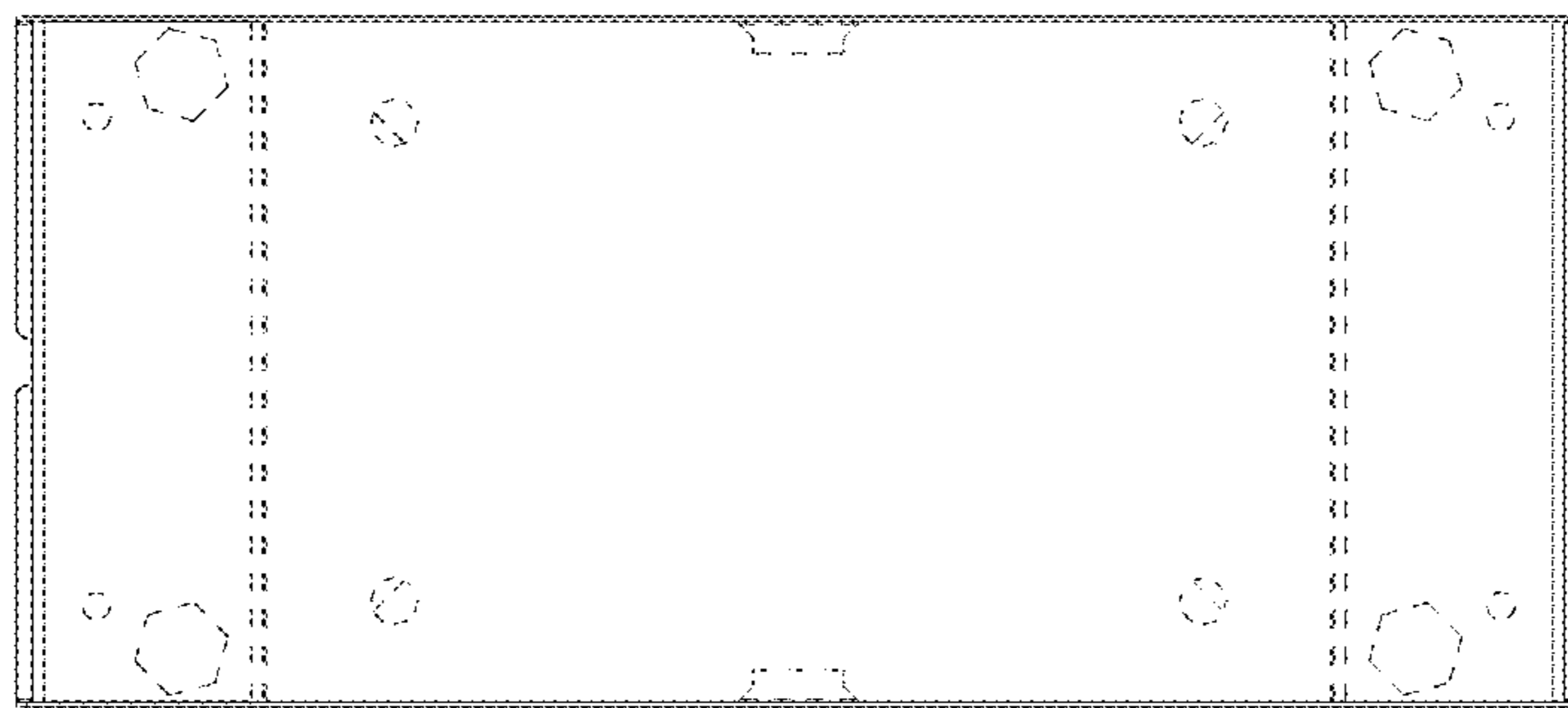

FIG. 7

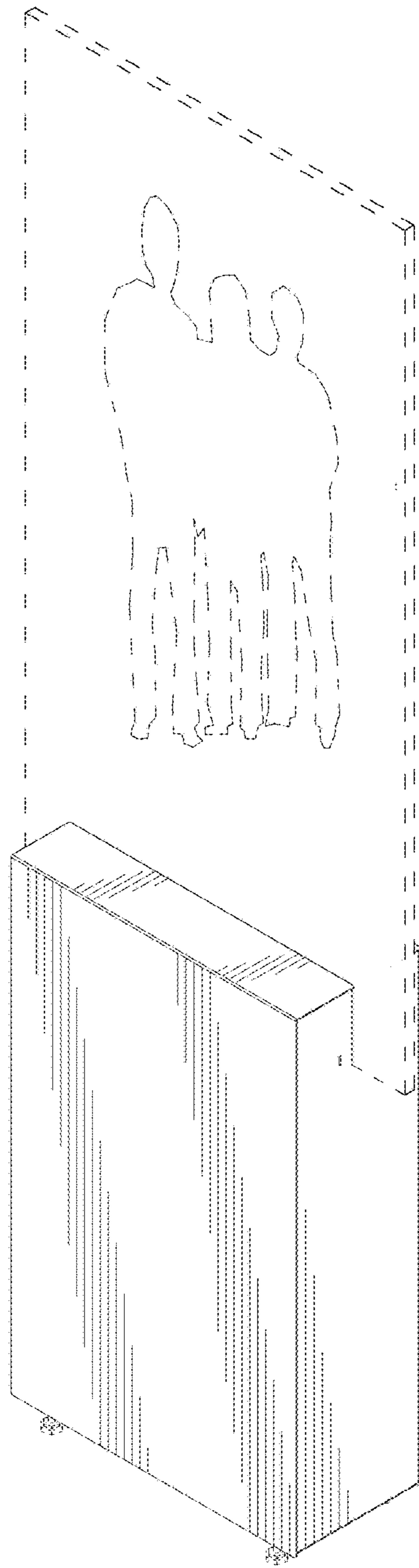

FIG.8

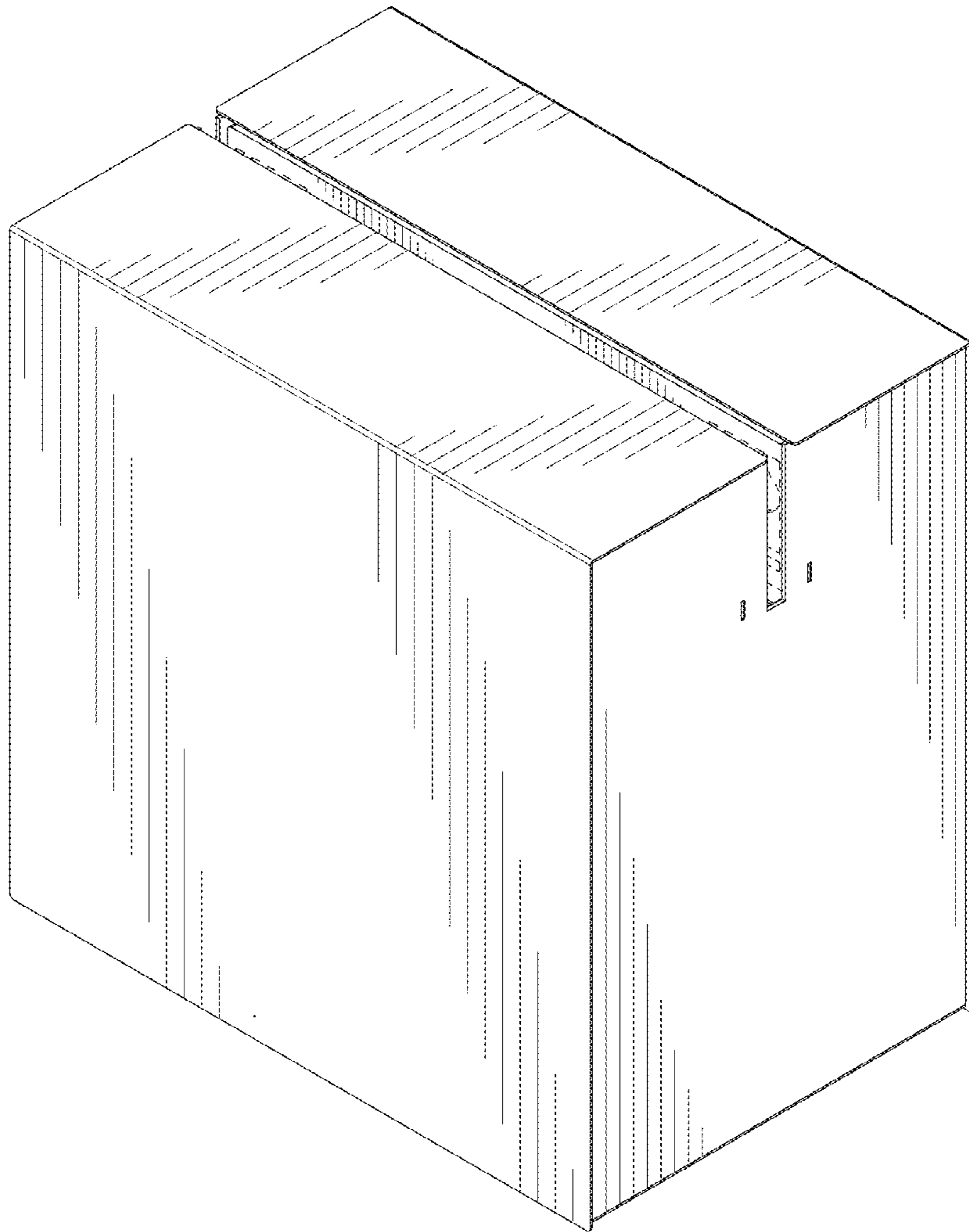

FIG.9

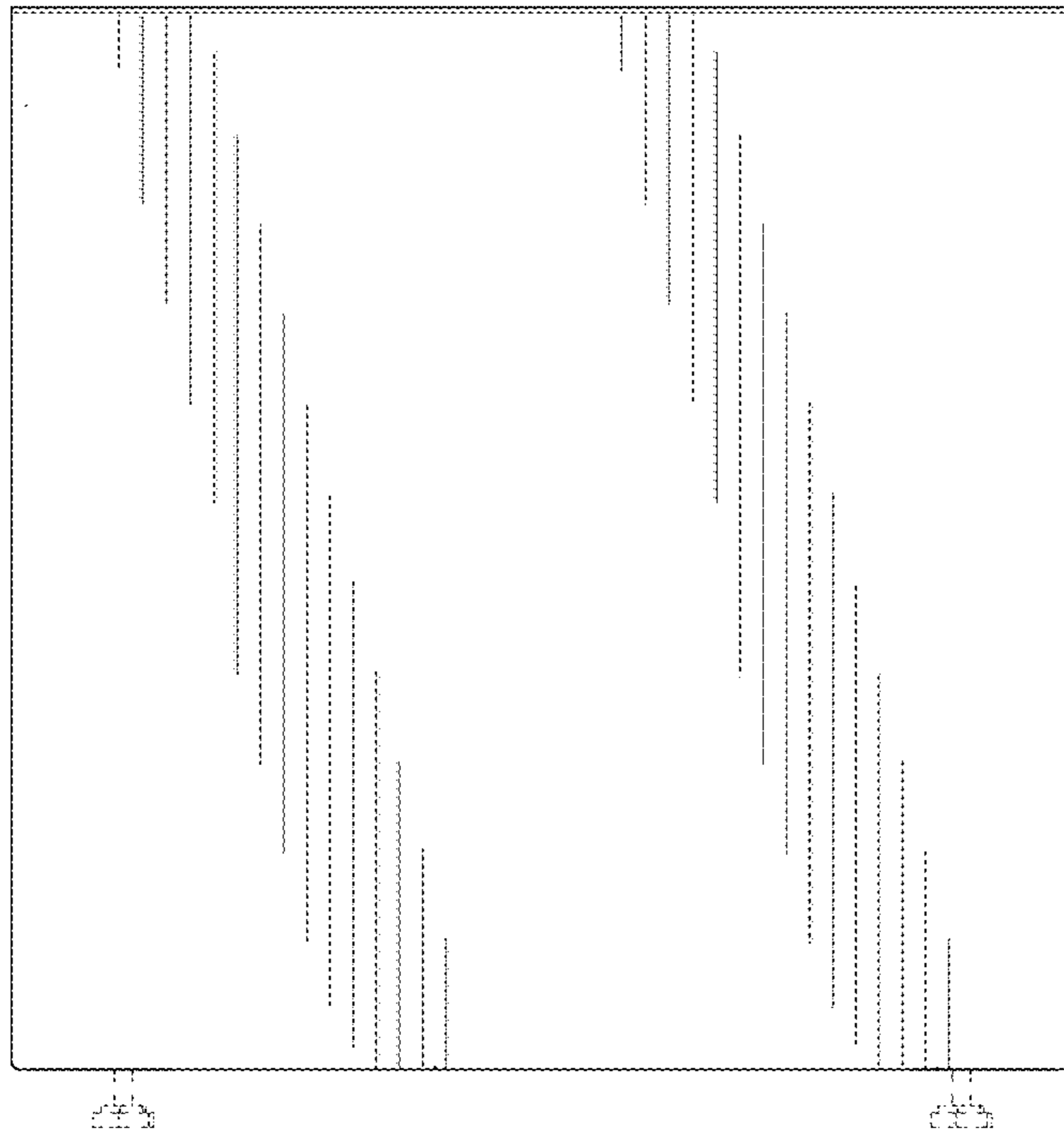

FIG.10

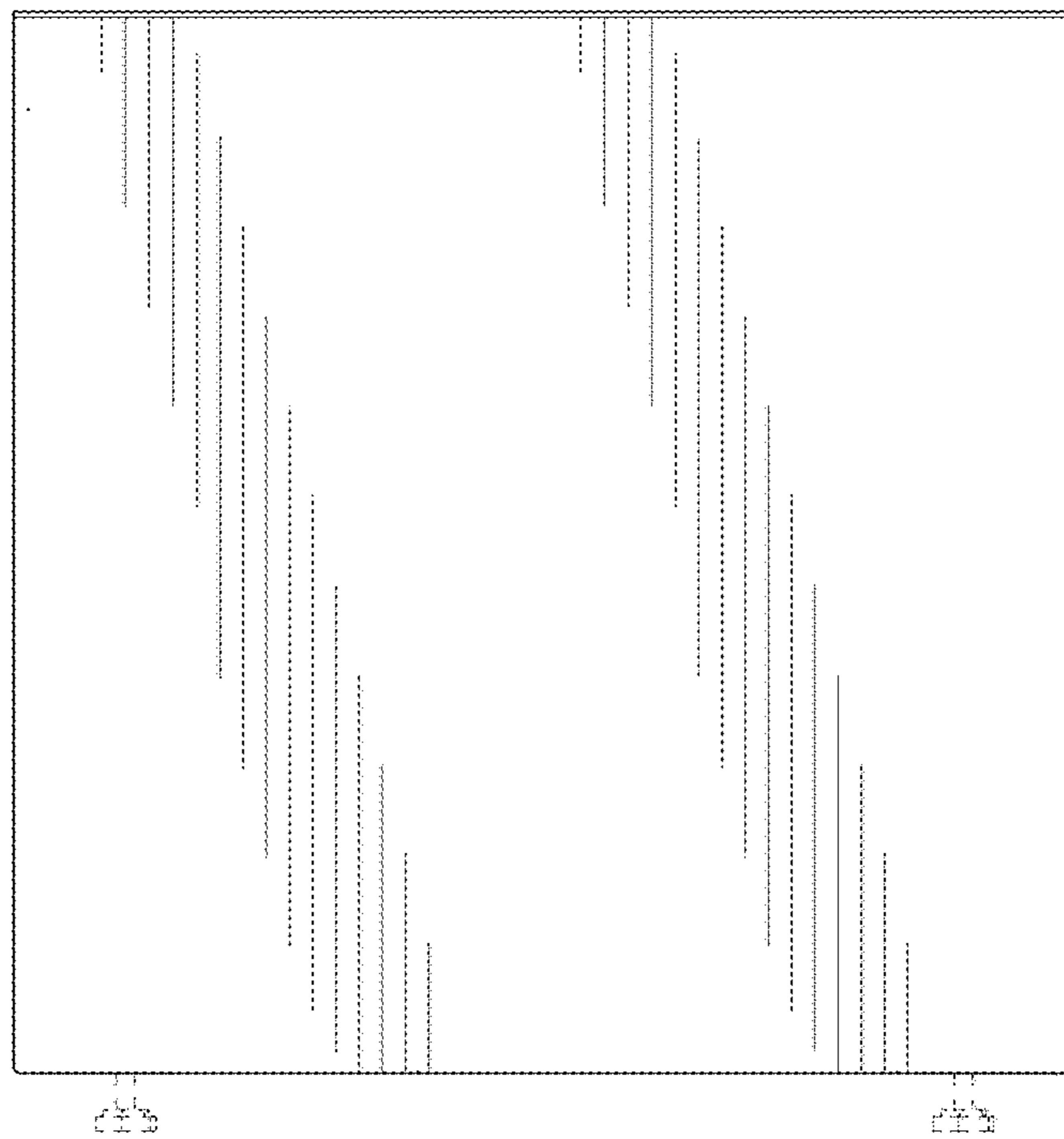

FIG.11

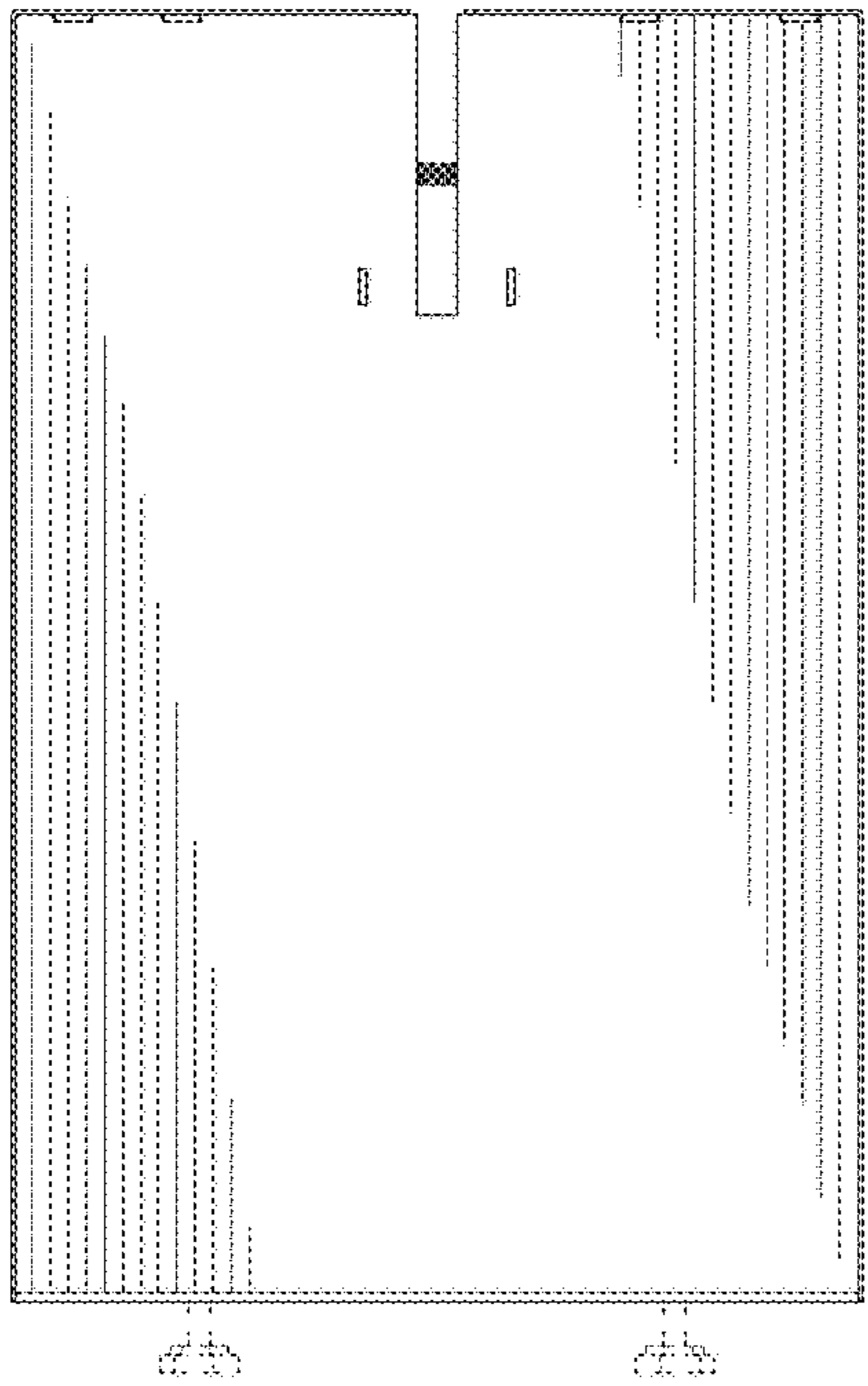

FIG. 12

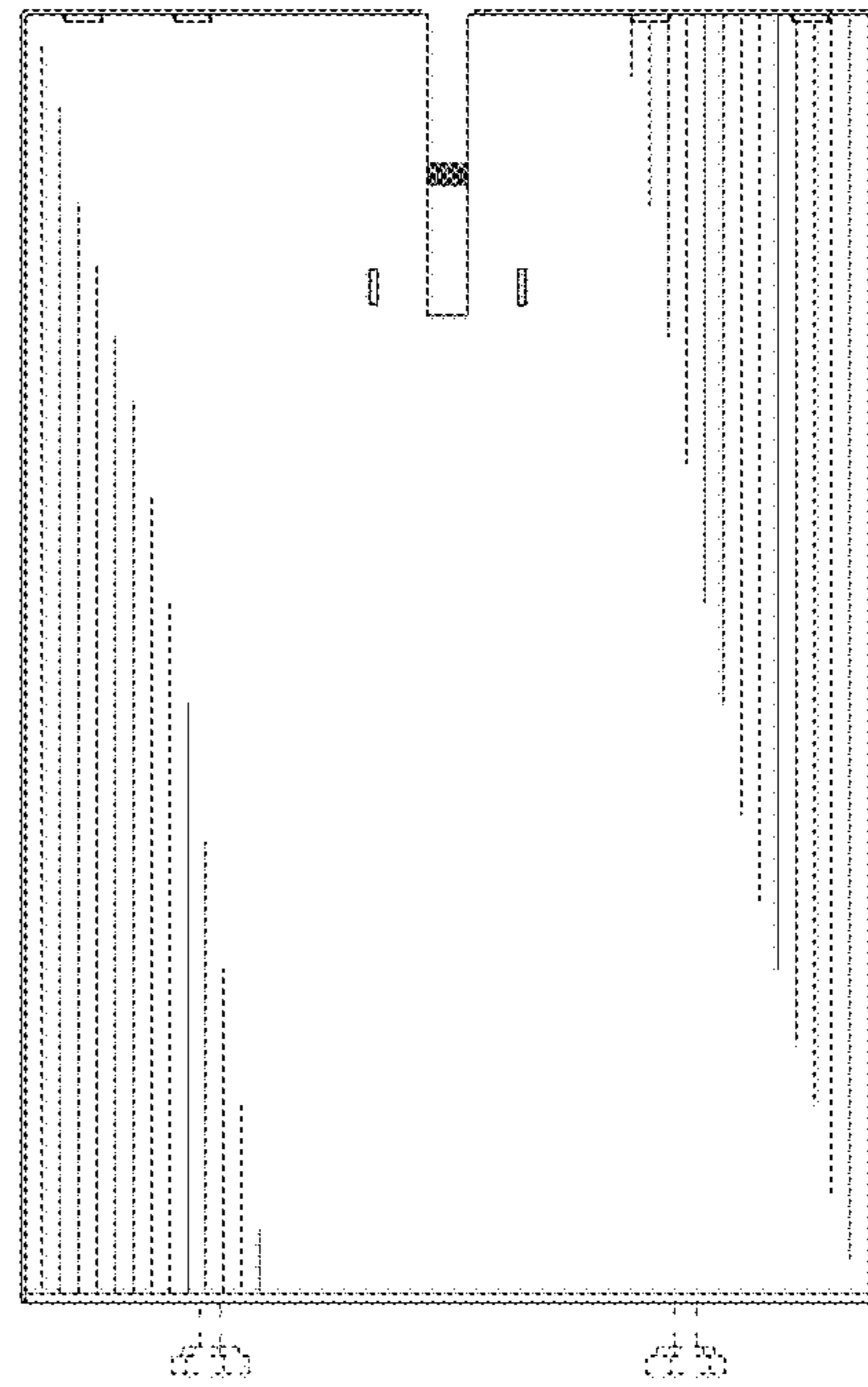

FIG. 13

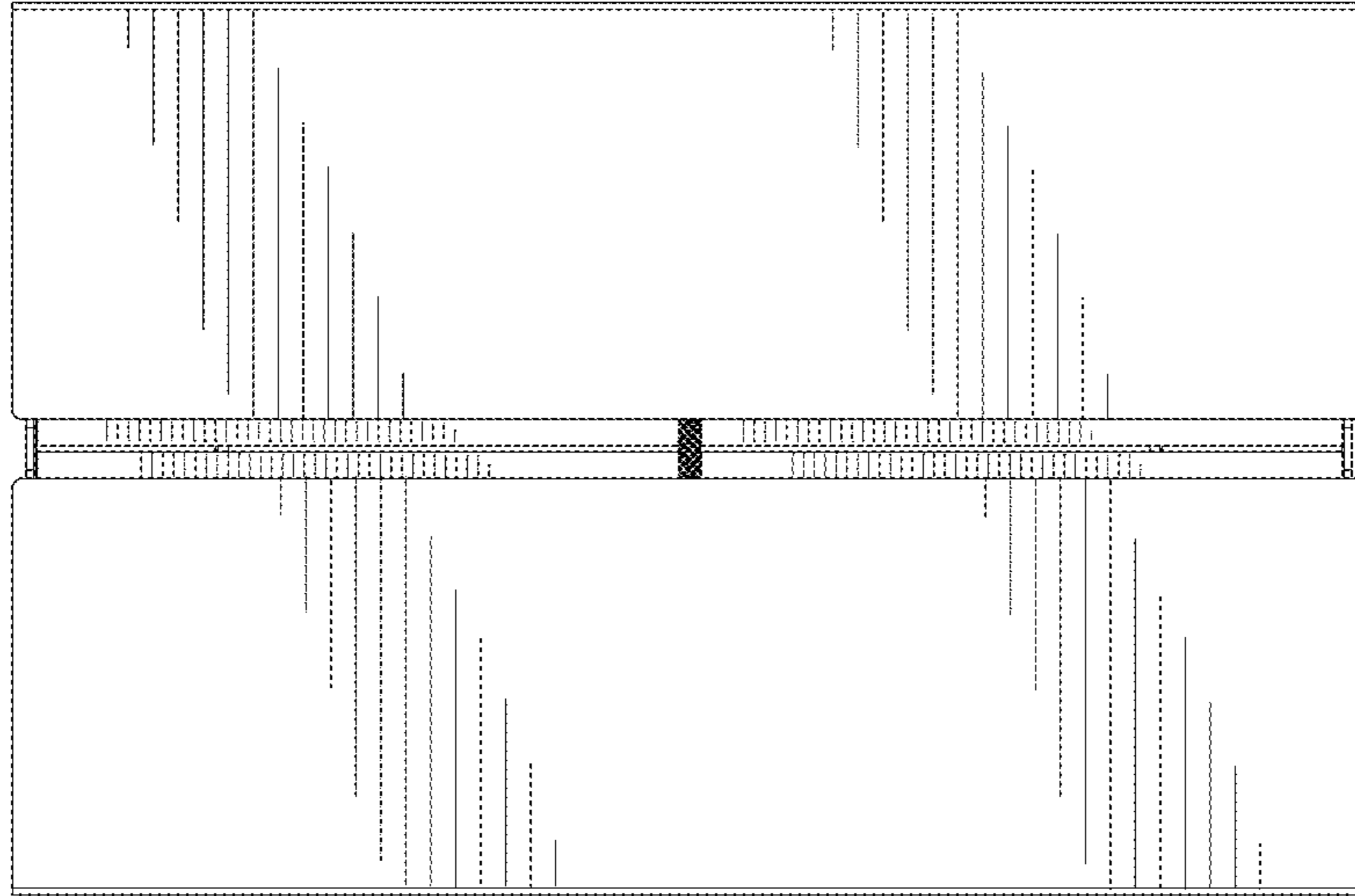

FIG.14

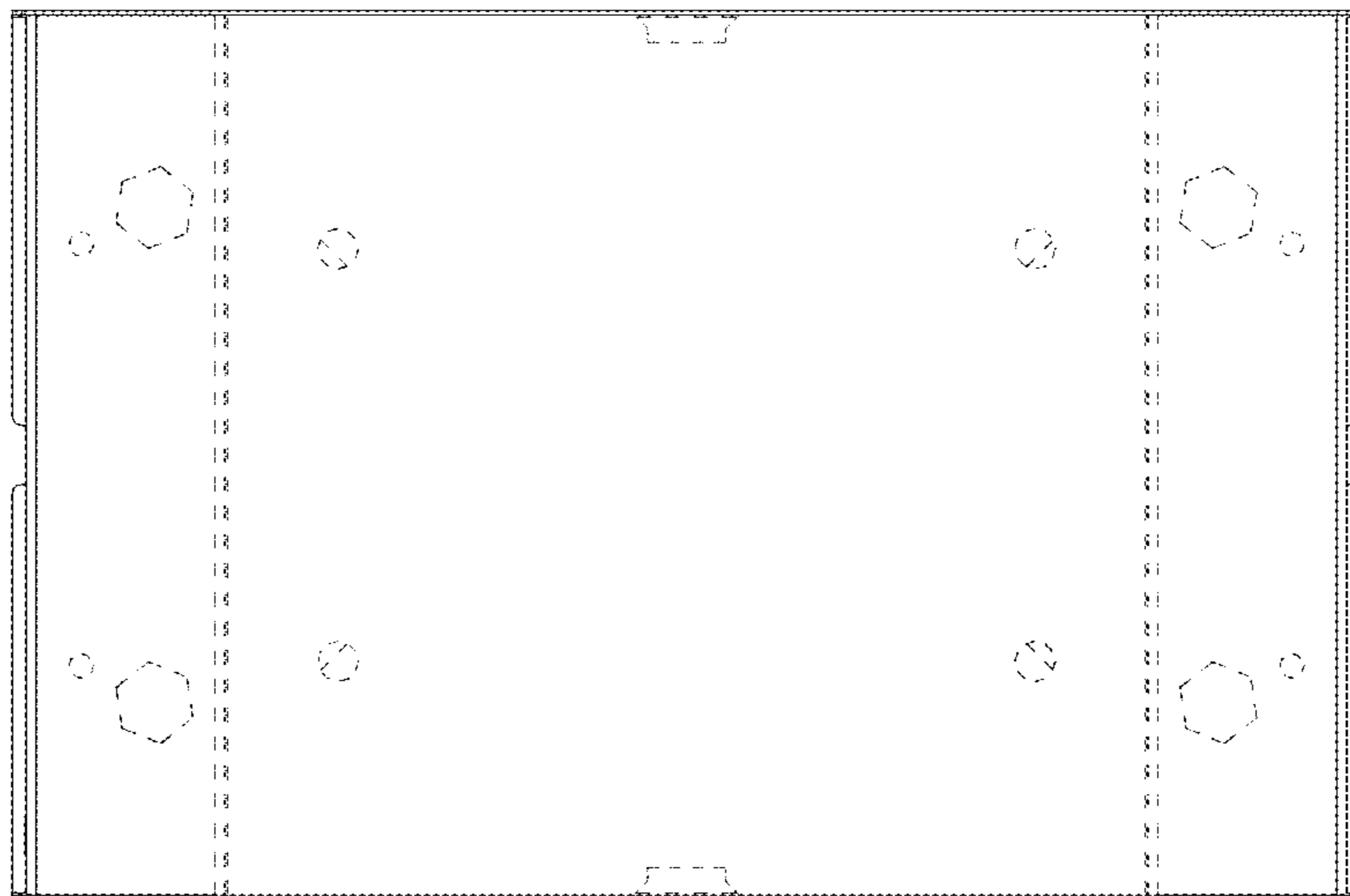

FIG.15

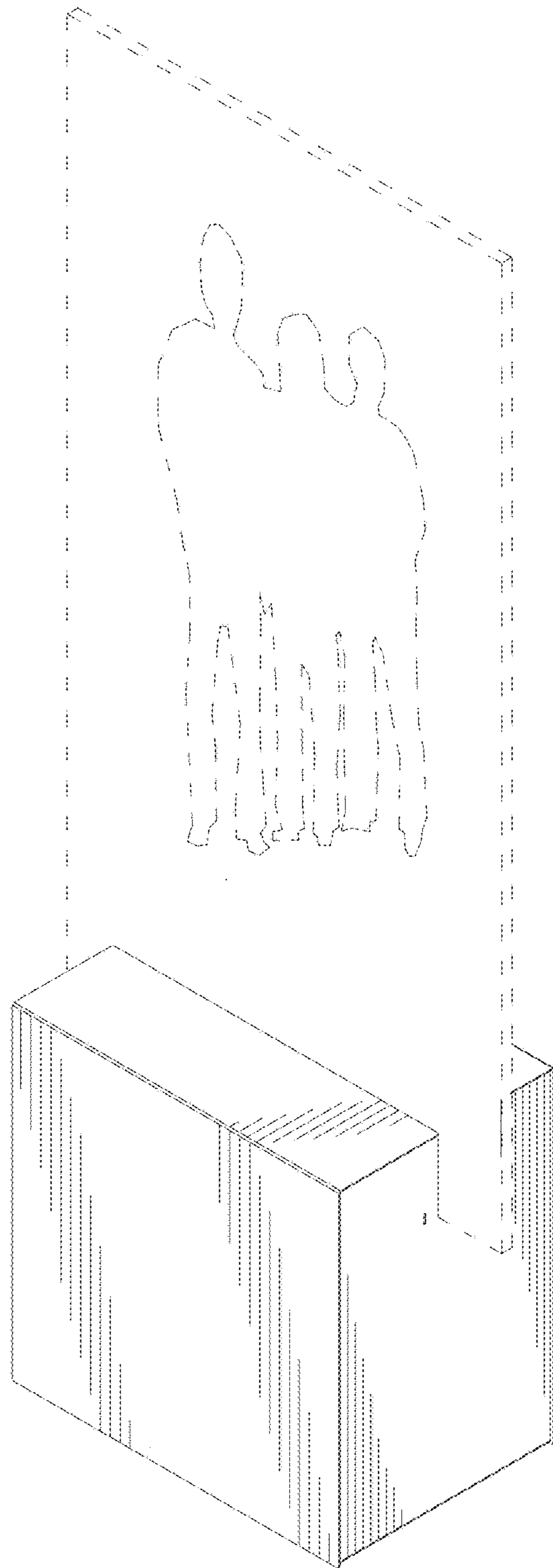

FIG.16

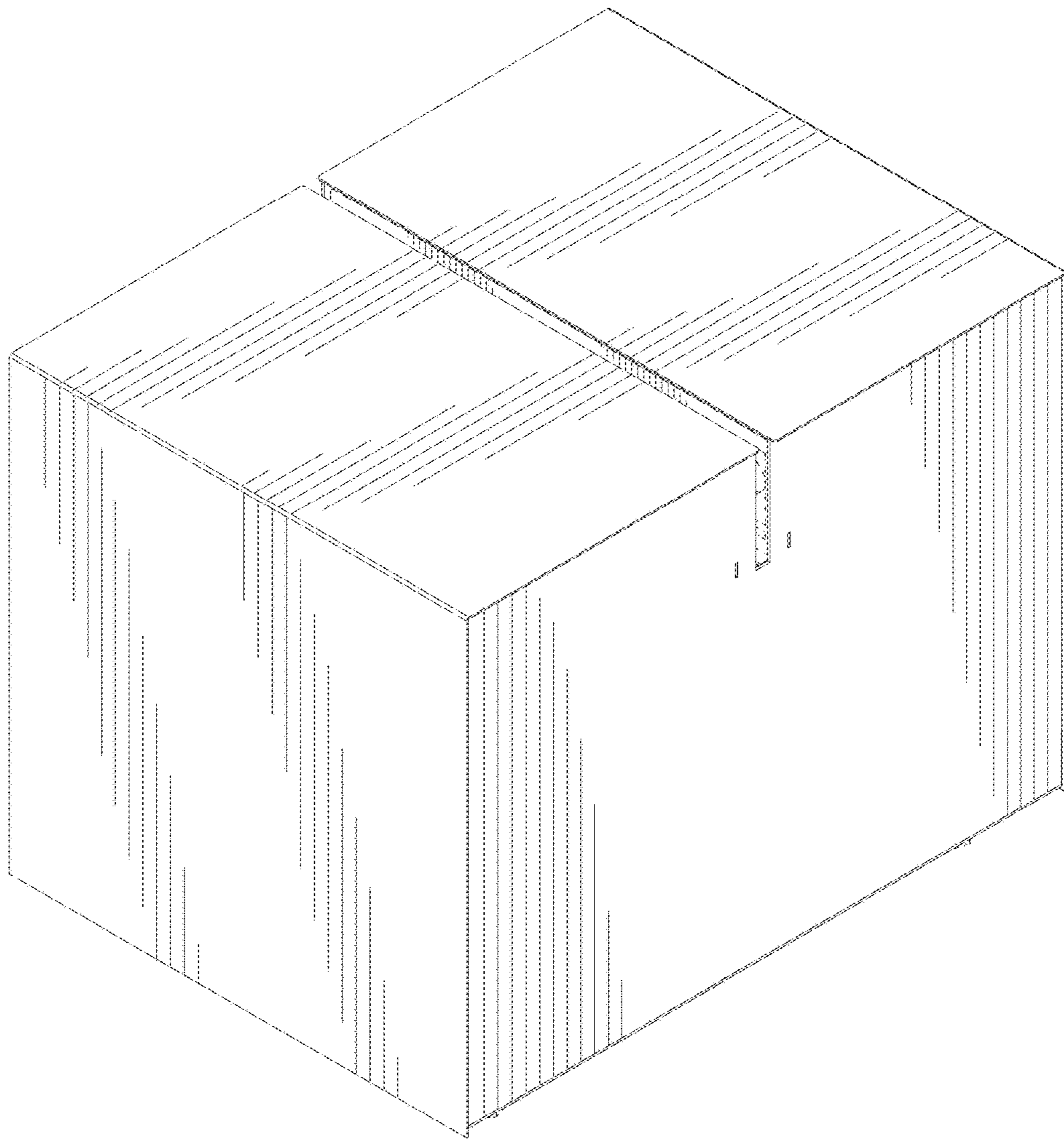

FIG.17

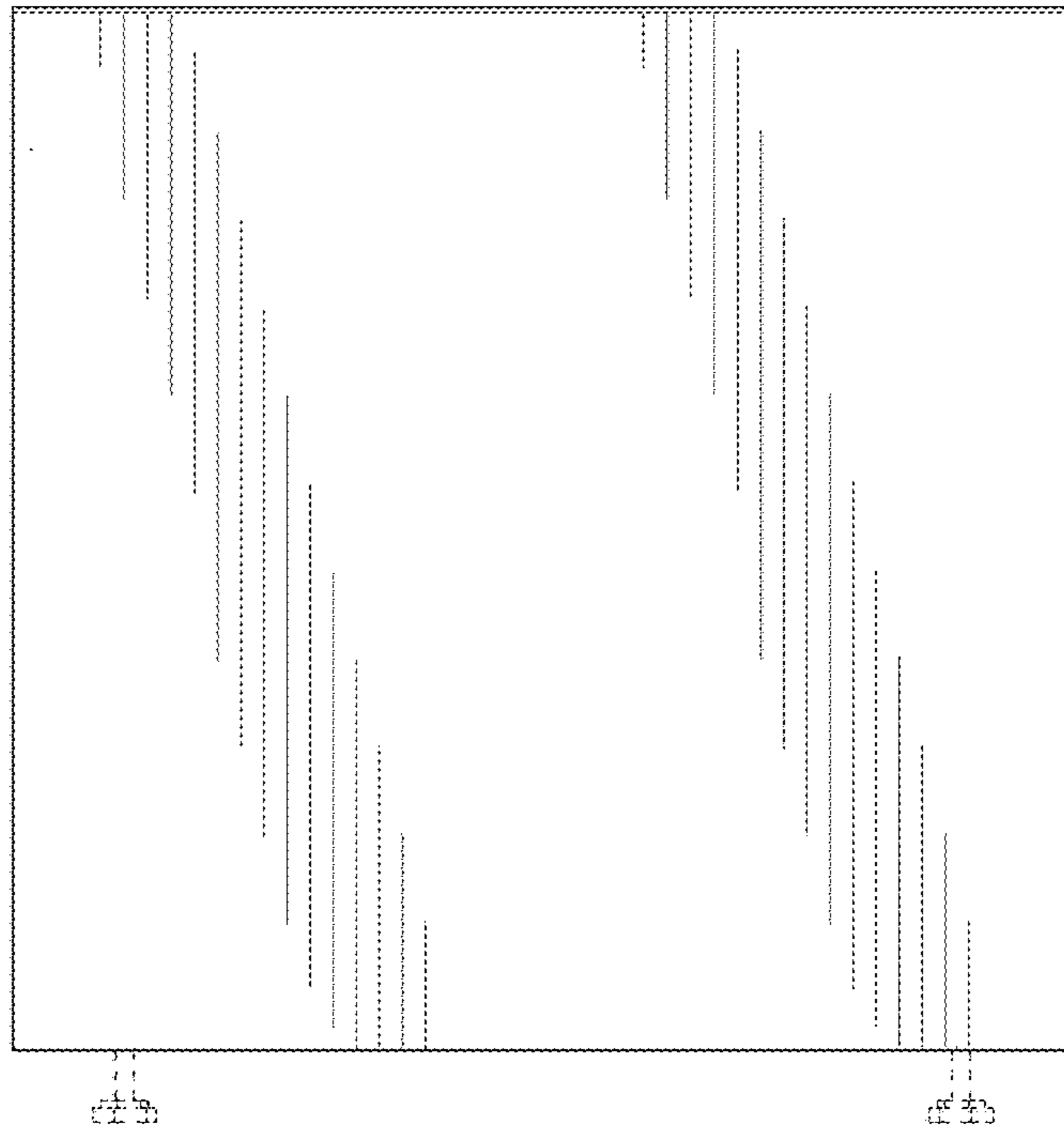

FIG. 18

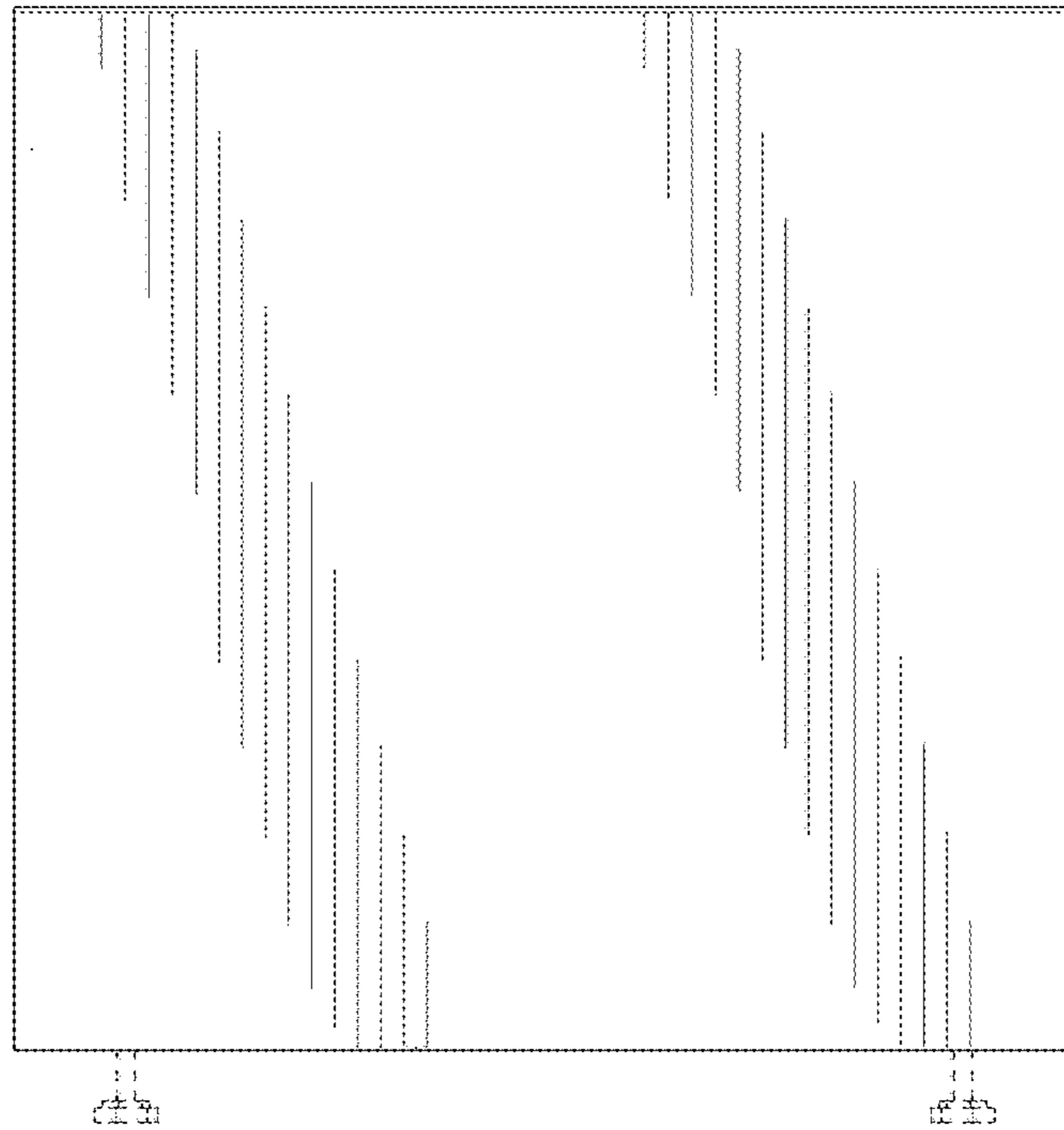

FIG. 19

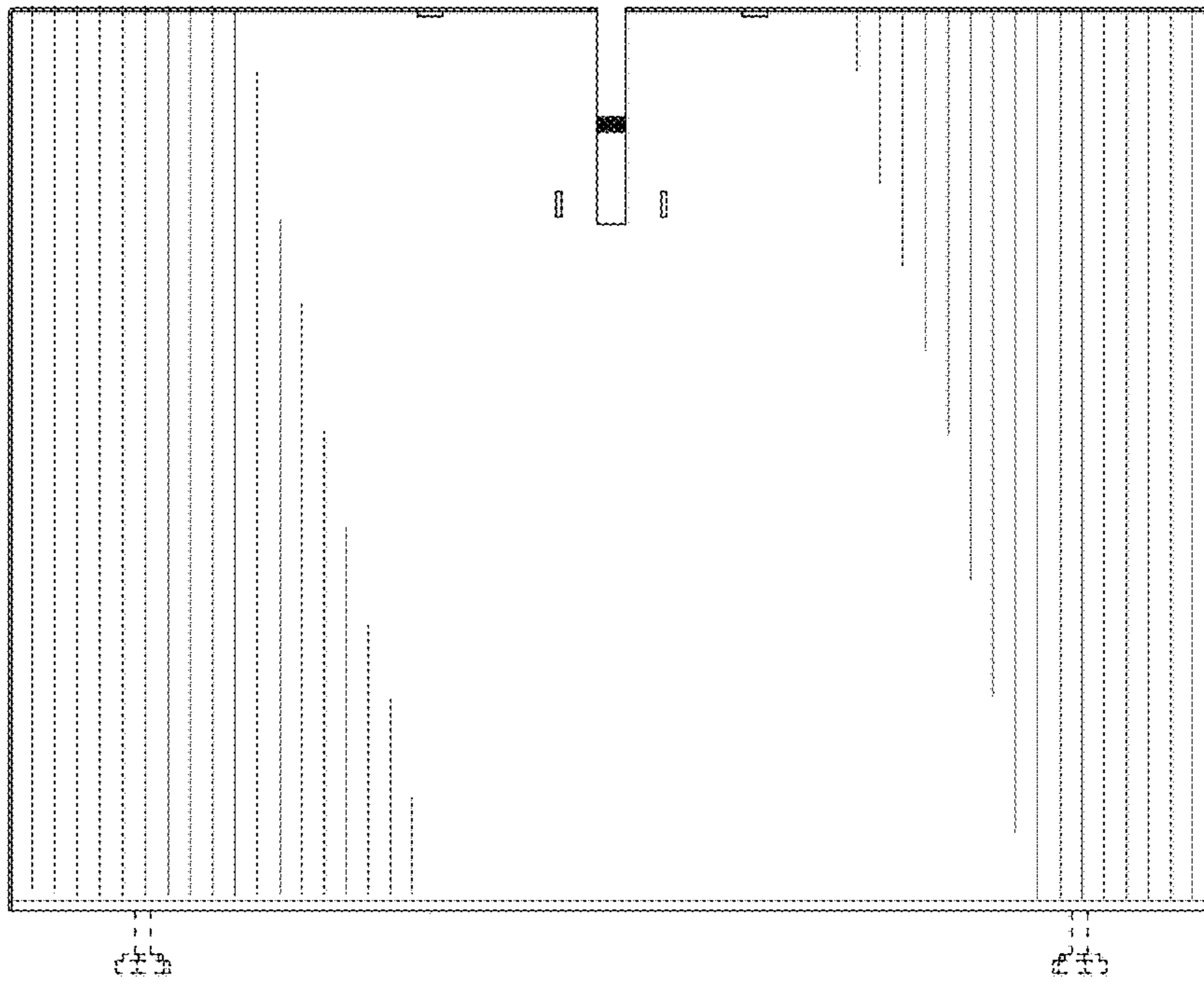

FIG. 20

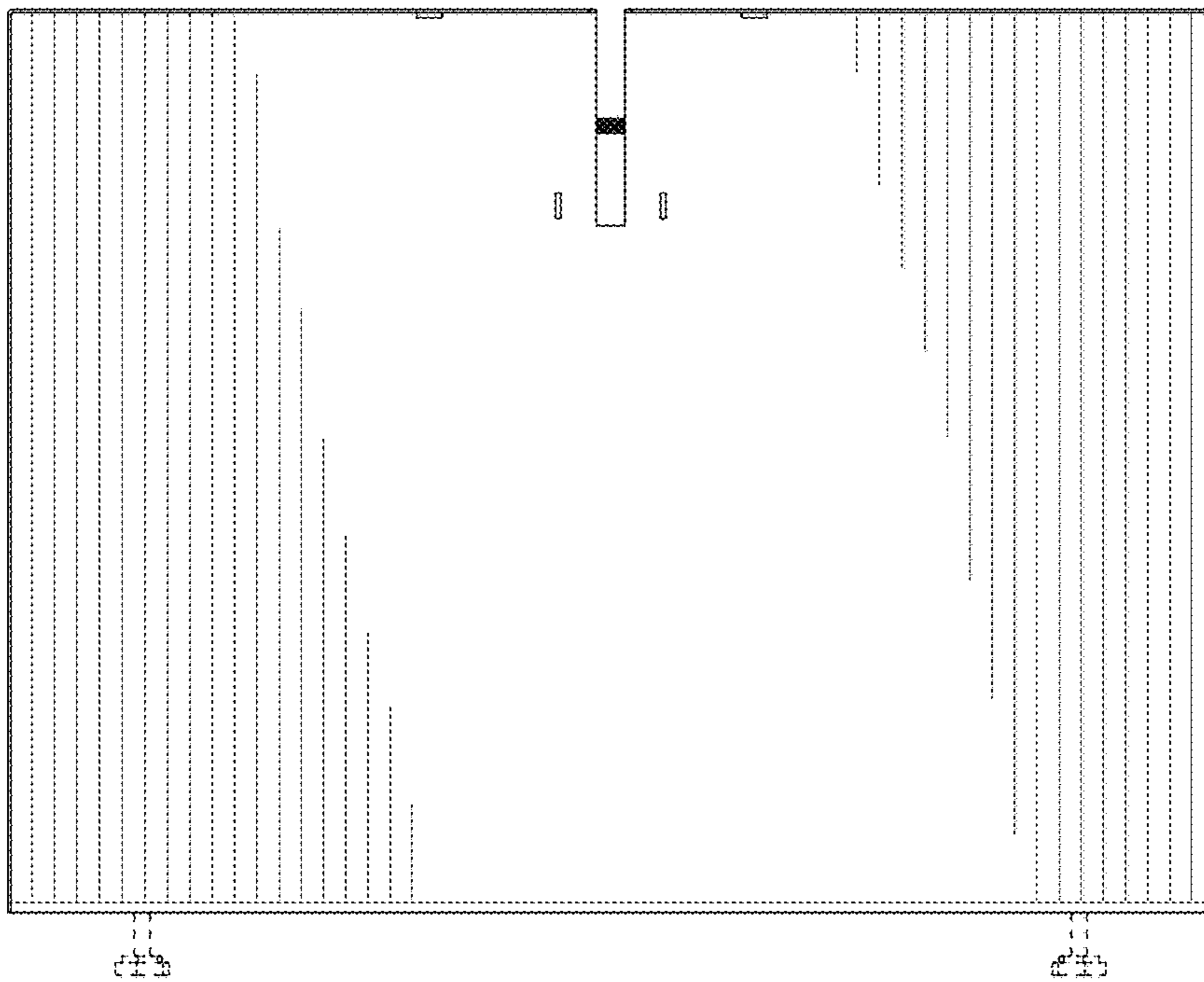

FIG. 21

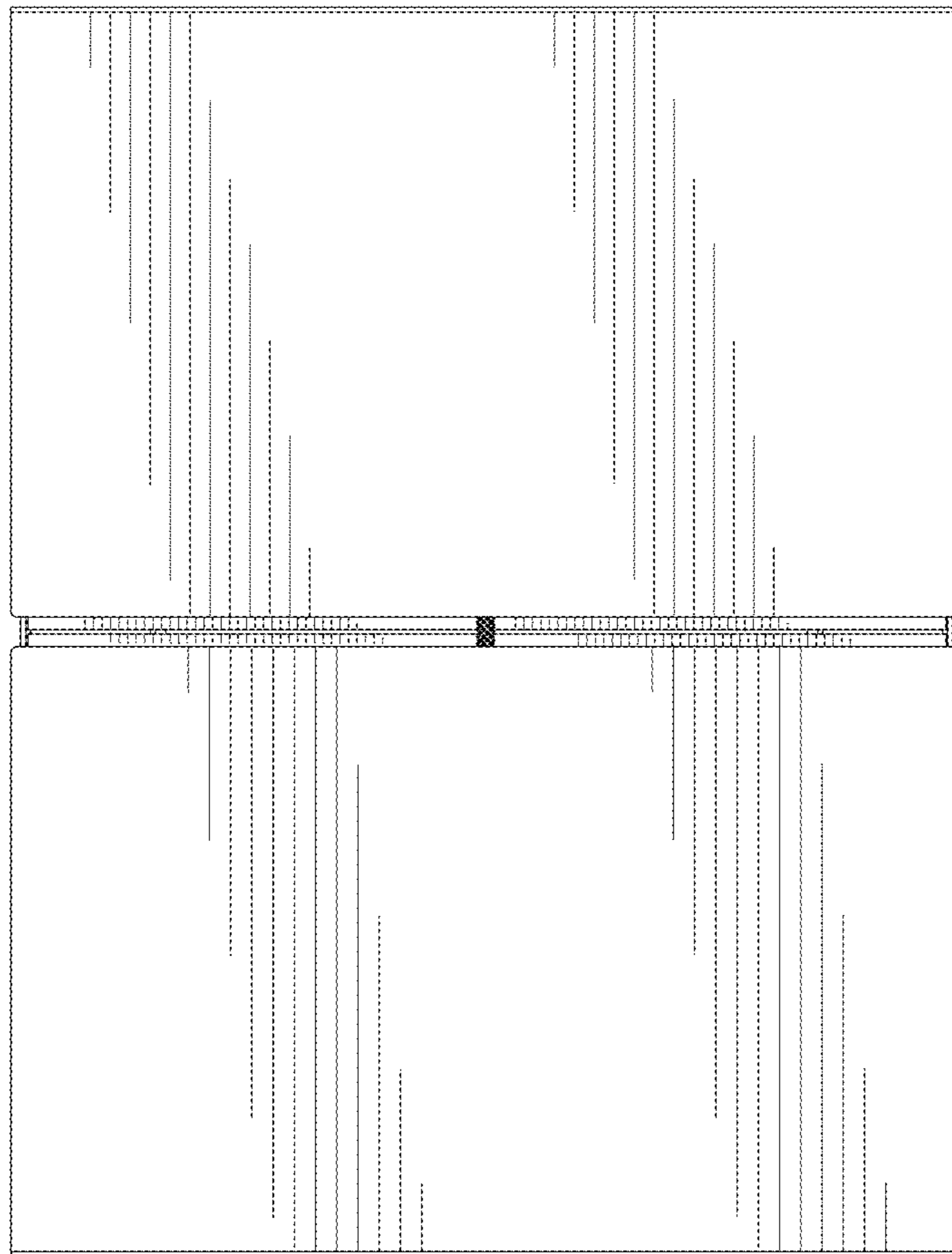

FIG.22

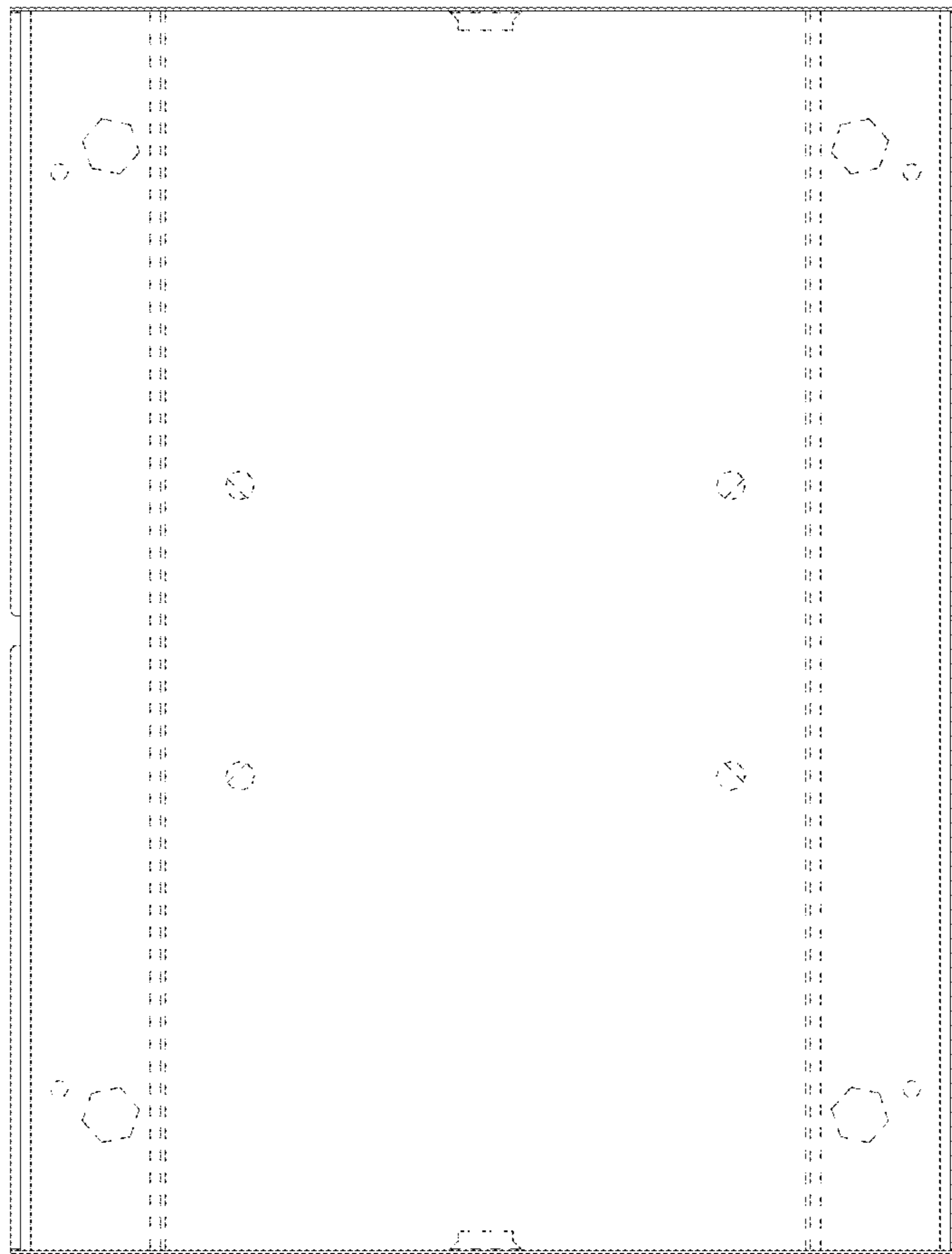

FIG.23

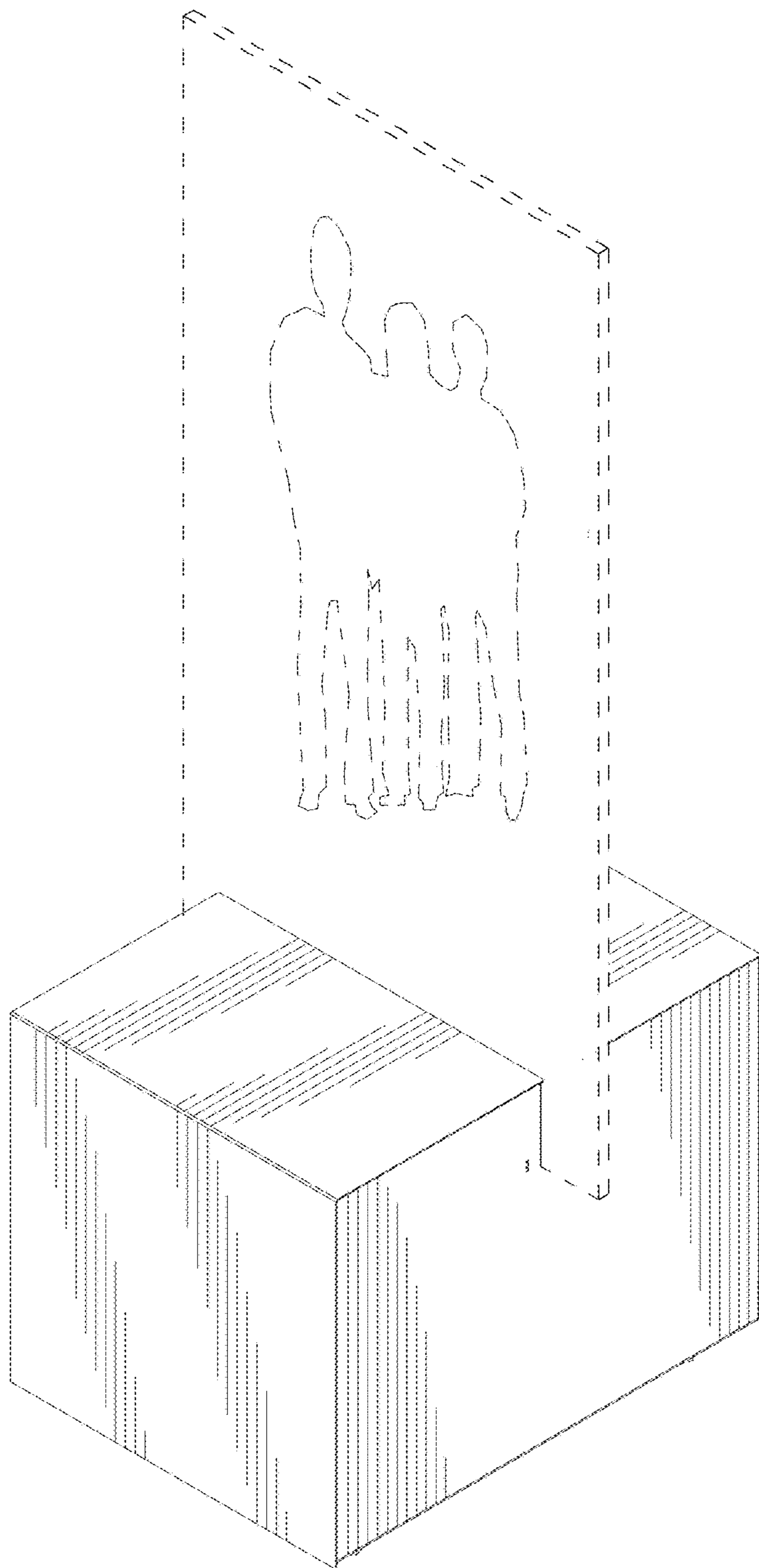

FIG.24