



US00D811094S

(12) **United States Design Patent**  
**Sedic**

(10) **Patent No.:** **US D811,094 S**  
(45) **Date of Patent:** **\*\* Feb. 27, 2018**

(54) **TOOTHBRUSH**

(71) Applicant: **Filip Sedic**, Shanghai (CN)

(72) Inventor: **Filip Sedic**, Shanghai (CN)

(\*\*) Term: **15 Years**

(21) Appl. No.: **29/585,179**

(22) Filed: **Nov. 21, 2016**

**Related U.S. Application Data**

(63) Continuation of application No. 29/542,030, filed on Oct. 9, 2015, now Pat. No. Des. 776,438.

(51) **LOC (11) Cl.** ..... **04-02**

(52) **U.S. Cl.**  
USPC ..... **D4/111**

(58) **Field of Classification Search**  
USPC ..... D1/106, 199; D4/100-104, 108-111, D4/127, 128, 132-136, 138, 199; D24/119, 146, 180; D30/158, 159  
CPC ..... A46B 5/00; A46B 2200/1066; A46B 2200/1073; A46B 2200/1086  
See application file for complete search history.

(56) **References Cited**

**U.S. PATENT DOCUMENTS**

659,593	A	10/1900	Richards
1,327,757	A	1/1920	Eggers
D59,127	S	9/1921	Perrault
2,225,331	A	12/1940	Campbell
3,734,106	A	5/1973	Zimmerman

(Continued)

**FOREIGN PATENT DOCUMENTS**

CN	2010070108	6/2008
FR	2909532	6/2008

(Continued)

*Primary Examiner* — Susan E Krakower

*Assistant Examiner* — L. A. Grabebstetter

(74) *Attorney, Agent, or Firm* — Evan Feldstein

(57) **CLAIM**

I claim the ornamental design for a toothbrush, as shown and described.

**DESCRIPTION**

FIG. 1 is a perspective view of a first embodiment of a toothbrush.

FIG. 2 is a front view of the first embodiment of the toothbrush.

FIG. 3 is a back view of the first embodiment of the toothbrush.

FIG. 4 is a left side view of the first embodiment of the toothbrush.

FIG. 5 is a right side view of the first embodiment of the toothbrush.

FIG. 6 is a top view of the first embodiment of the toothbrush.

FIG. 7 is a bottom view of the first embodiment of the toothbrush.

FIG. 8 is a perspective view of a second embodiment of the toothbrush.

FIG. 9 is a front view of the second embodiment of the toothbrush.

FIG. 10 is a back view of the second embodiment of the toothbrush.

FIG. 11 is a left side view of the second embodiment of the toothbrush.

FIG. 12 is a right side view of the second, embodiment of the toothbrush.

FIG. 13 is a top view of the second embodiment of the toothbrush; and,

FIG. 14 is a bottom view of the second embodiment of the toothbrush.

The broken lines depict portions of the toothbrush that form no part of the claimed design.

**1 Claim, 14 Drawing Sheets**

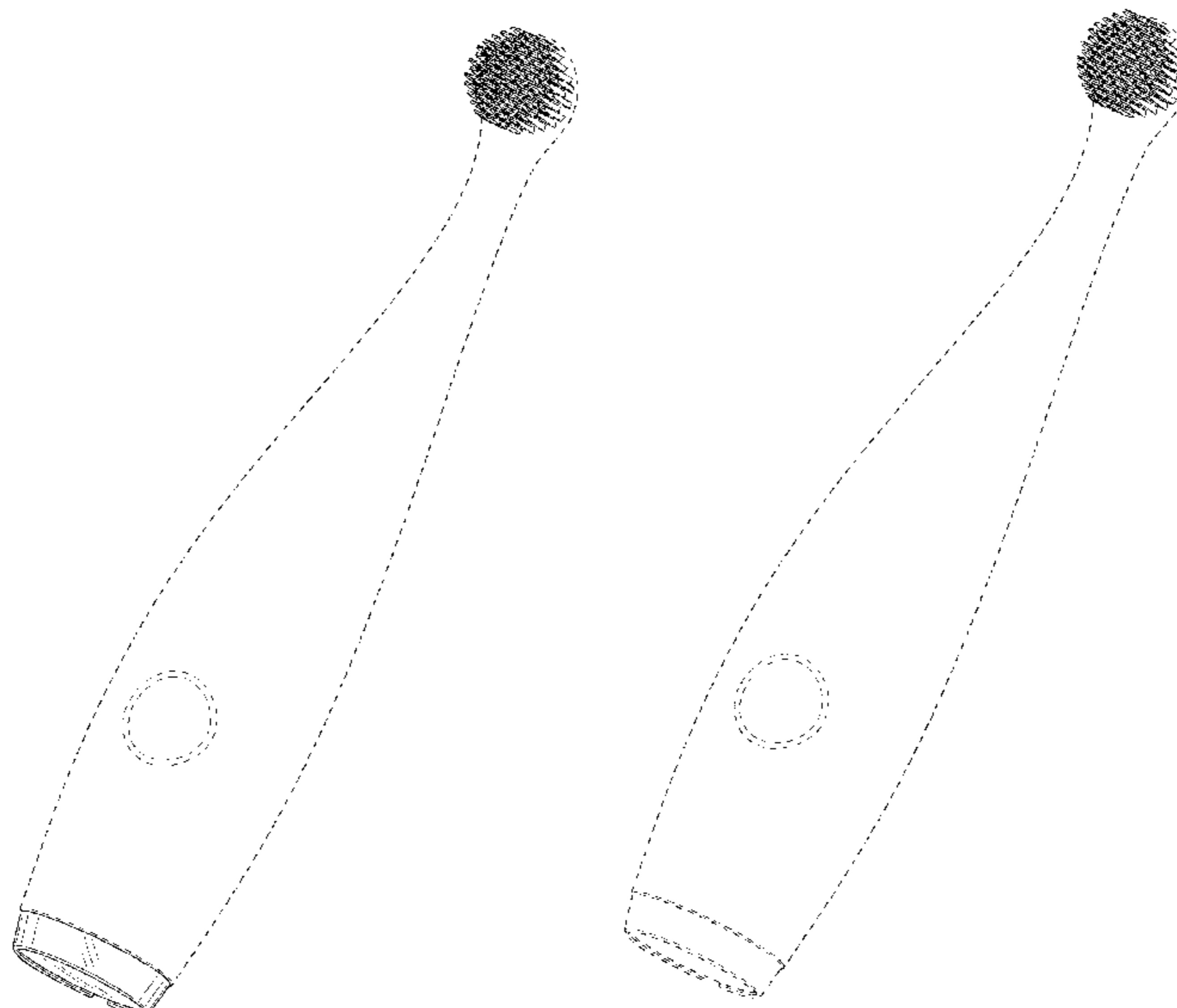

(56)

References Cited

U.S. PATENT DOCUMENTS

4,486,109 A \* 12/1984 Rosofsky ..... A46B 7/04  
15/110  
4,543,679 A \* 10/1985 Rosofsky ..... A46B 5/0016  
15/104.92  
4,608,968 A \* 9/1986 Rosofsky ..... A46B 7/04  
401/132  
D388,958 S \* 1/1998 Hartwein ..... D4/101  
D402,116 S 12/1998 Magloff et al.  
5,956,796 A 9/1999 Lodato  
D419,774 S 2/2000 Langue  
D444,303 S 7/2001 Reille  
D456,607 S \* 5/2002 Carlucci ..... D4/101  
6,490,760 B1 12/2002 Lauer et al.  
D503,852 S 4/2005 Hensel  
D509,362 S \* 9/2005 Maeda ..... D4/101  
D526,487 S \* 8/2006 Chenvainu ..... D4/101  
D532,202 S \* 11/2006 Hohlbein ..... D4/111  
D536,452 S 2/2007 Geiberger et al.  
7,303,347 B1 \* 12/2007 Duncan ..... A46B 15/0091  
206/223  
D577,199 S \* 9/2008 Zhuan ..... D4/101  
D578,772 S 10/2008 Provost et al.  
D579,664 S \* 11/2008 Fisher ..... D4/101  
D606,317 S \* 12/2009 Driesen ..... D4/101  
D611,254 S 3/2010 Lee  
D612,611 S \* 3/2010 Brown, Jr. .... D4/101  
D617,563 S 6/2010 Wagner  
D639,068 S 6/2011 Cobabe et al.  
D669,687 S 10/2012 Heil et al.

D676,662 S 2/2013 Jimenez et al.  
D687,636 S \* 8/2013 Driesen ..... D4/101  
D689,698 S \* 9/2013 Dickie ..... D4/101  
8,549,693 B2 10/2013 Gruber et al.  
D693,581 S 11/2013 Ballmaier et al.  
D706,033 S \* 6/2014 Dickie ..... D4/101  
D734,614 S \* 7/2015 Driesen ..... D4/101  
2003/0037391 A1 2/2003 Pfenniger et al.  
2005/0241091 A1 11/2005 Foster et al.  
2006/0064833 A1 3/2006 Jacobs  
2007/0050931 A1 3/2007 Jimenez et al.  
2007/0251034 A1 11/2007 Meressa et al.  
2007/0254260 A1 \* 11/2007 Alden, IV ..... A46B 15/0055  
433/85  
2008/0196184 A1 8/2008 Dooley  
2009/0007357 A1 \* 1/2009 Meadows ..... A46B 9/005  
15/167.1  
2010/0024143 A1 2/2010 Dickie  
2011/0010874 A1 1/2011 Dickie  
2011/0151404 A1 6/2011 Dombrowski  
2012/0036665 A1 \* 2/2012 Cho ..... A46B 9/026  
15/167.1  
2012/0121316 A1 \* 5/2012 Brown ..... A46B 11/0003  
401/282  
2013/0061412 A1 3/2013 Vashi

FOREIGN PATENT DOCUMENTS

KR 10-2012-0026955 3/2012  
WO WO2005096882 10/2005

\* cited by examiner

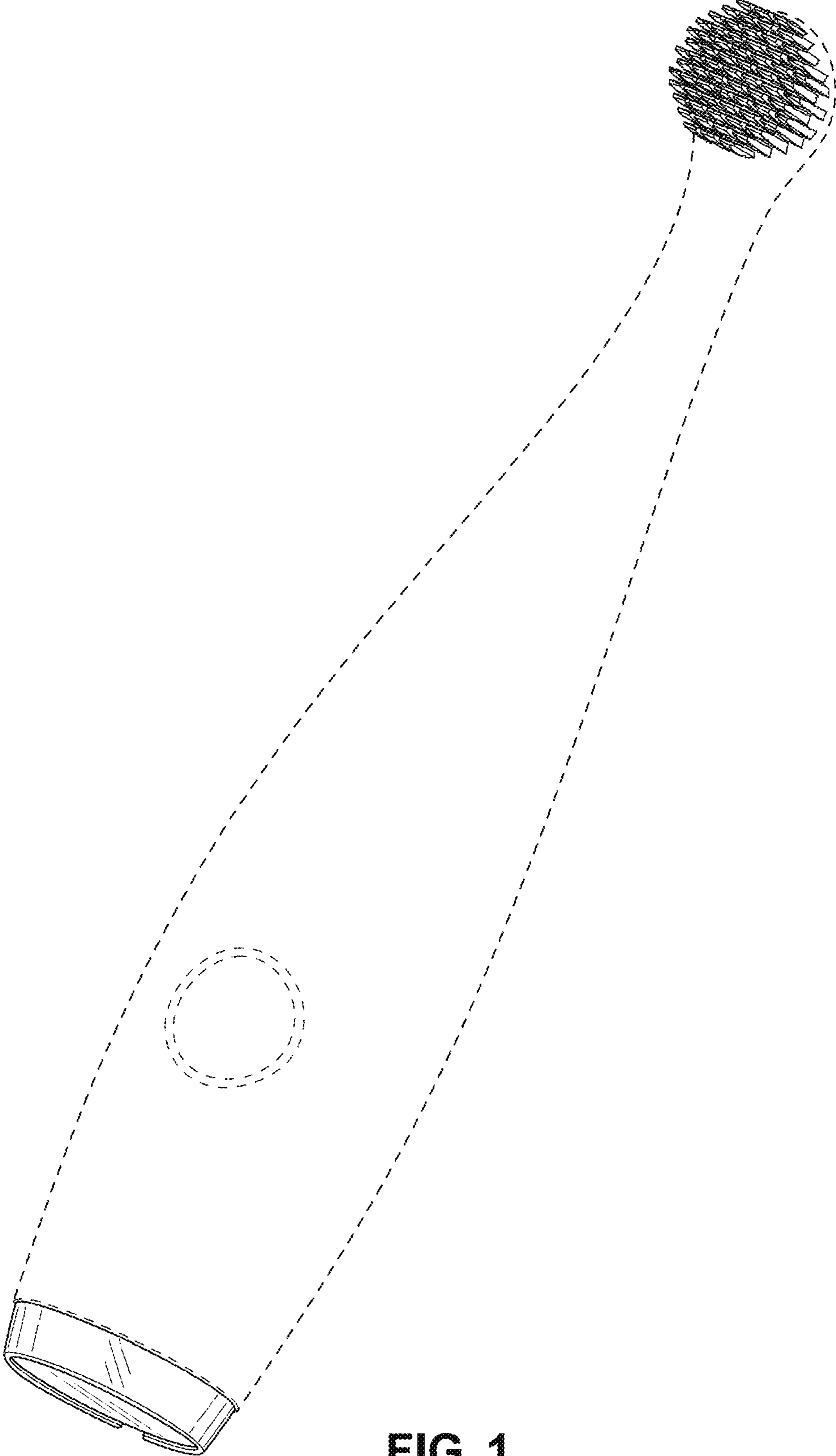
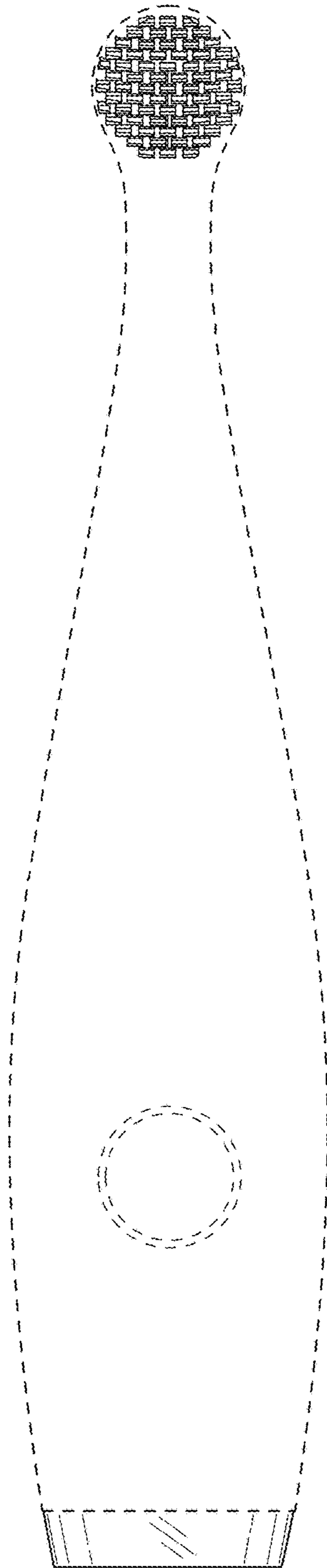
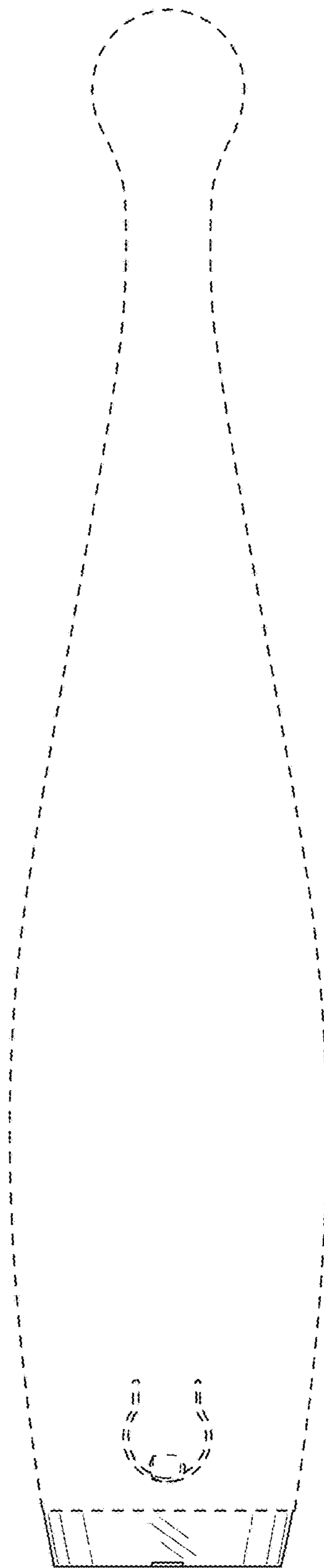

FIG. 1



**FIG. 2**



**FIG. 3**

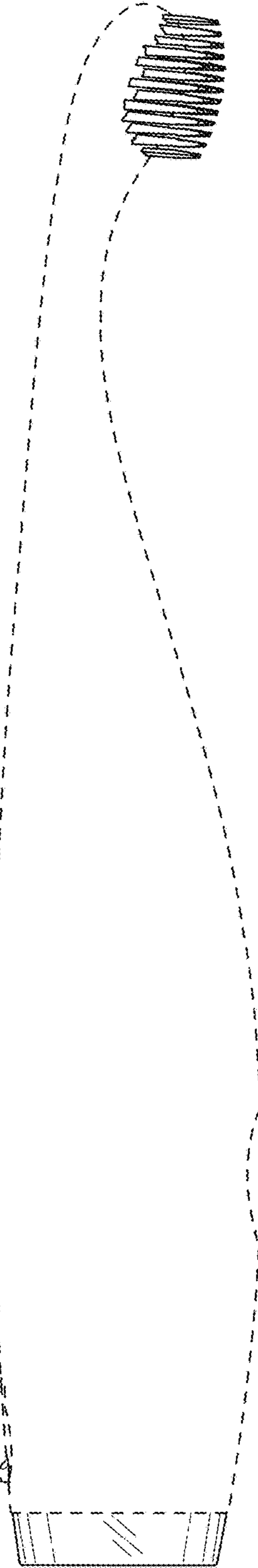

FIG. 4

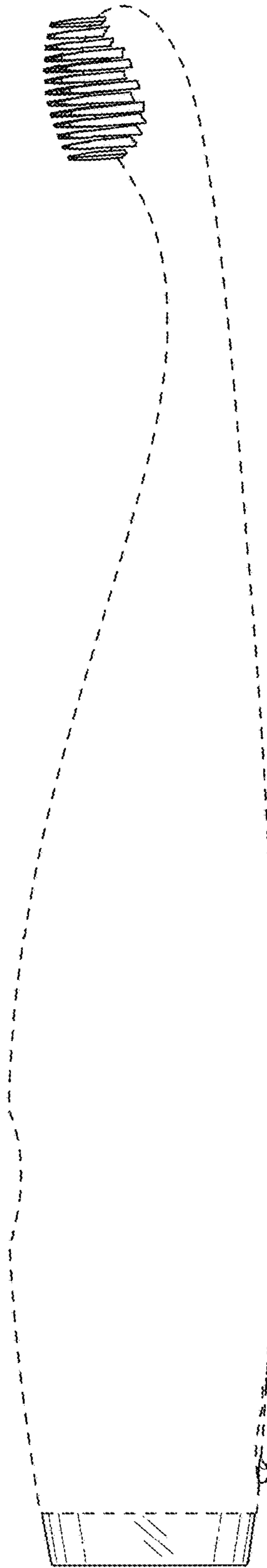
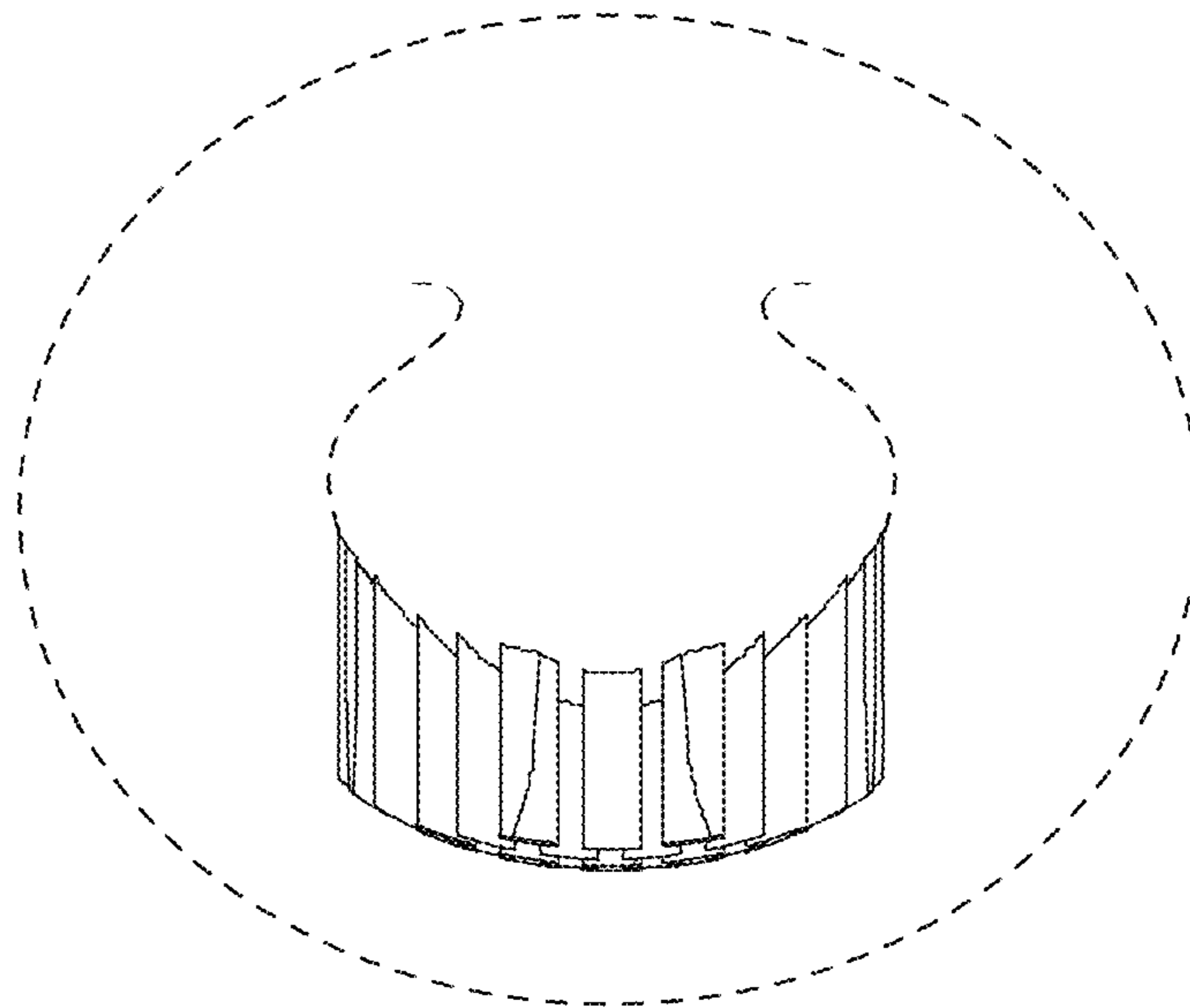
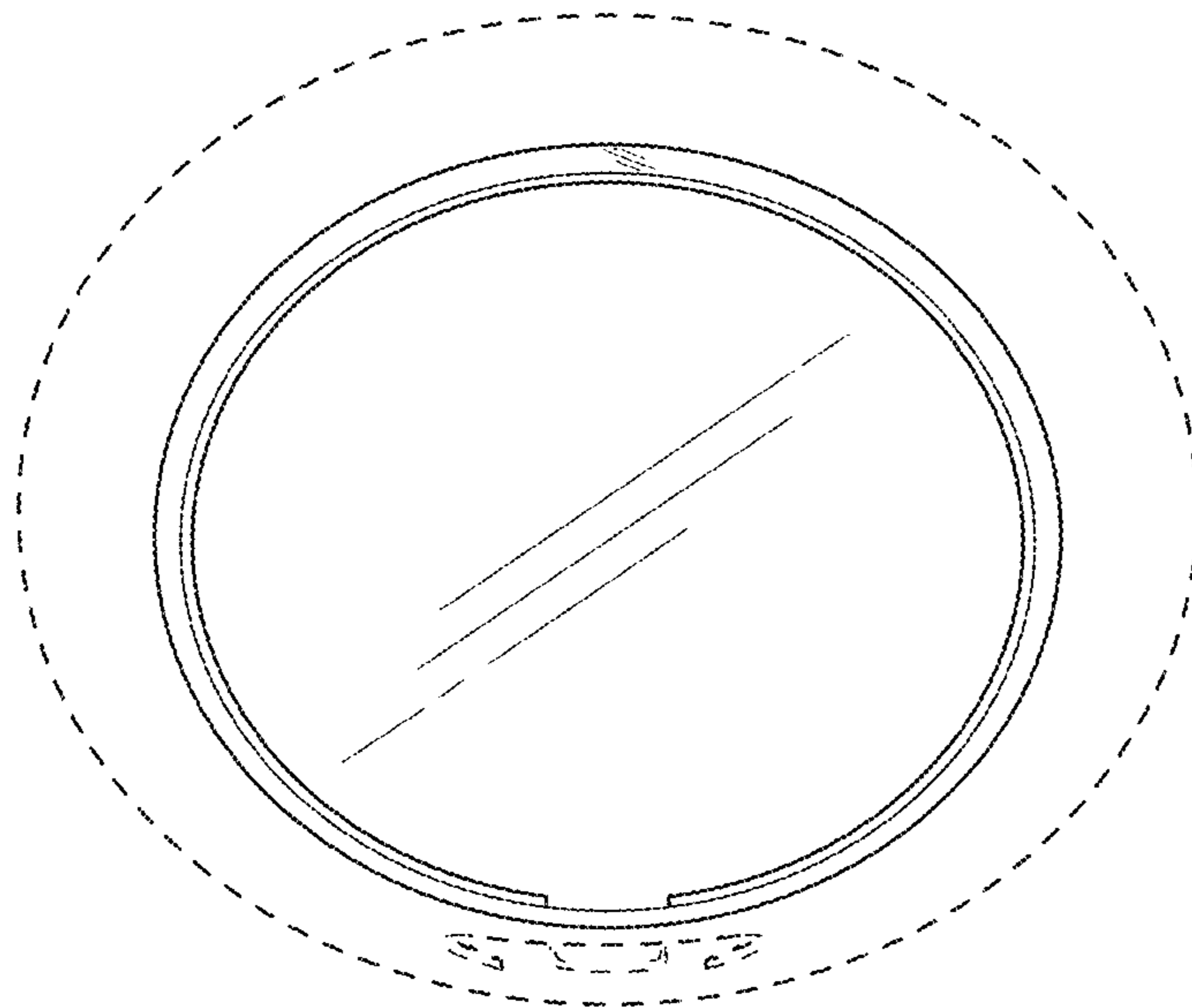

FIG. 5



**FIG. 6**





**FIG. 7**

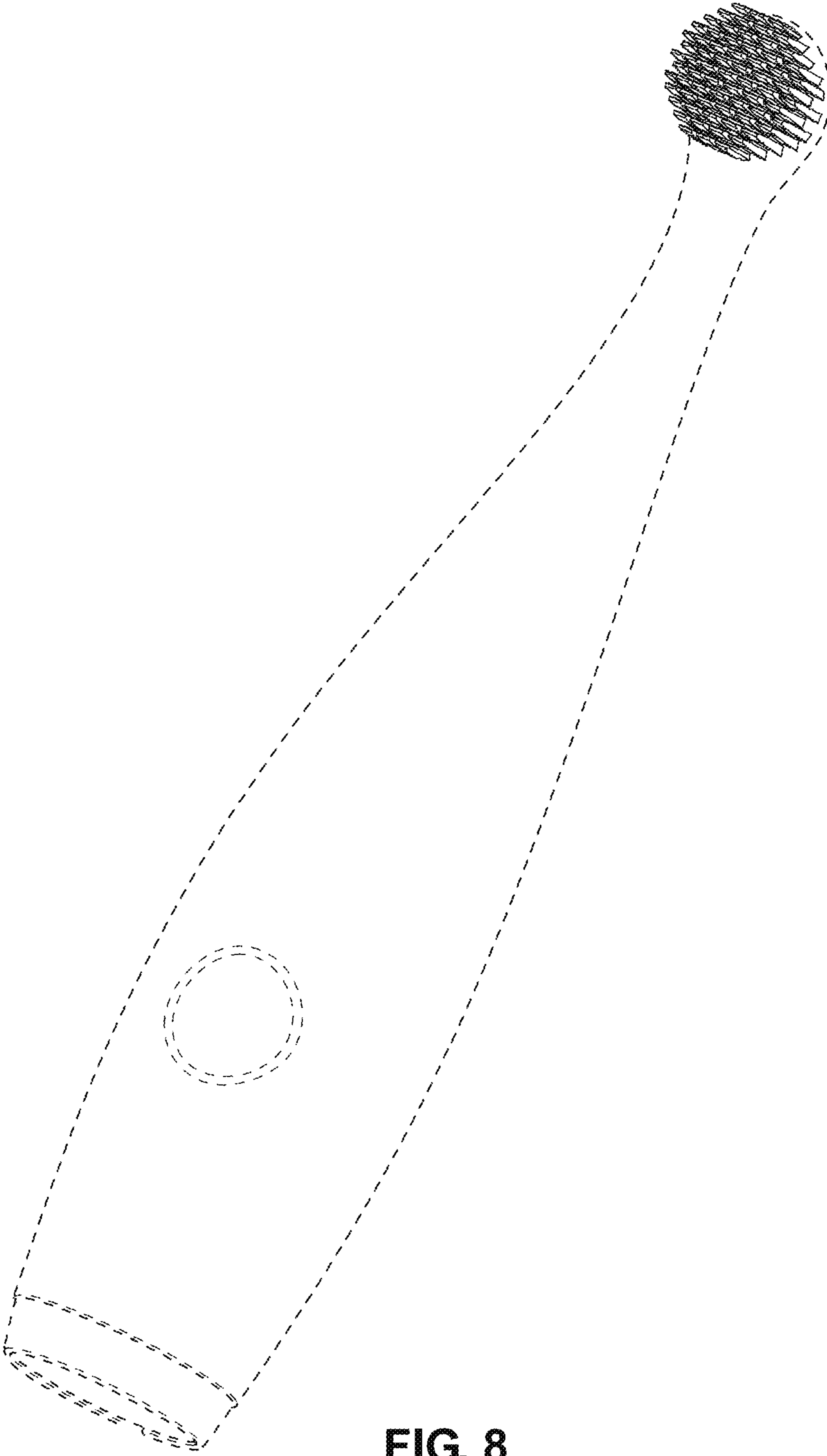
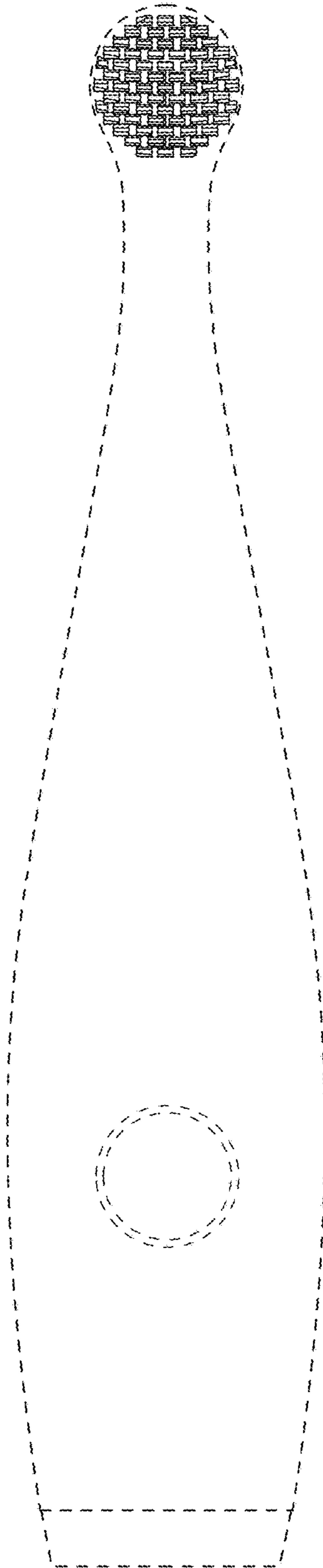
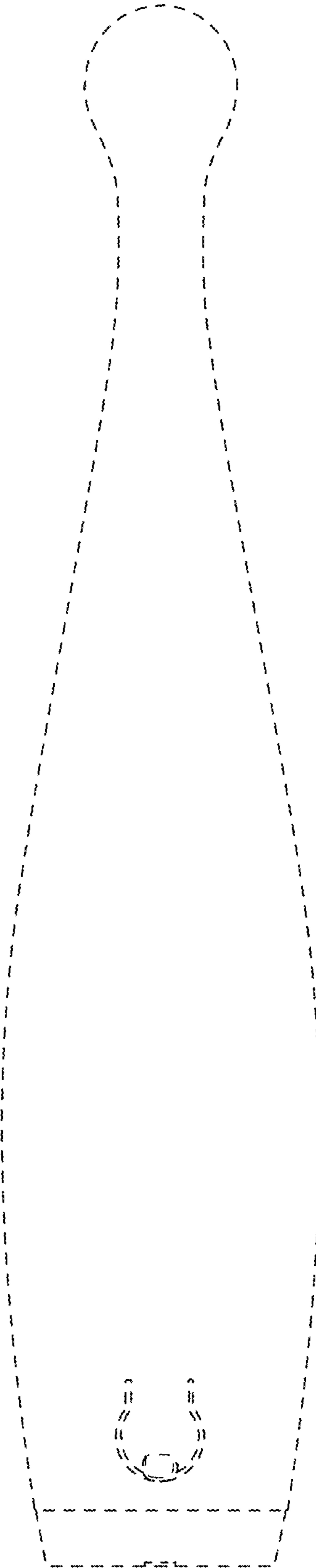

FIG. 8



**FIG. 9**



**FIG. 10**

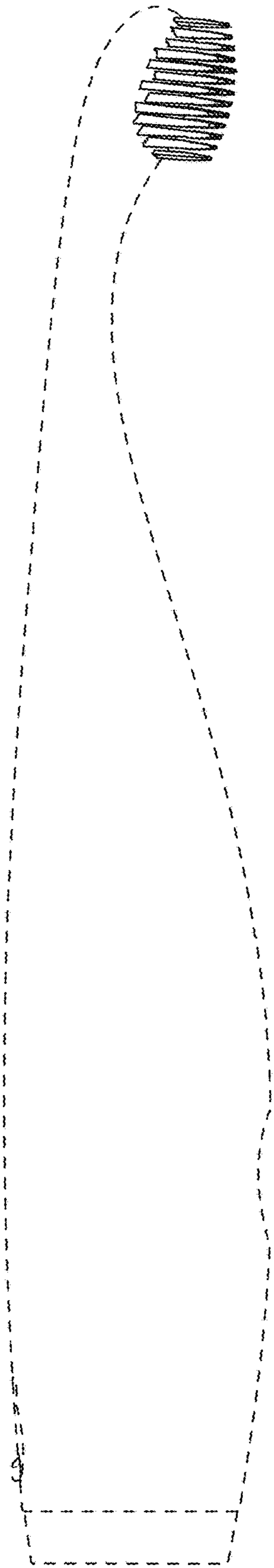
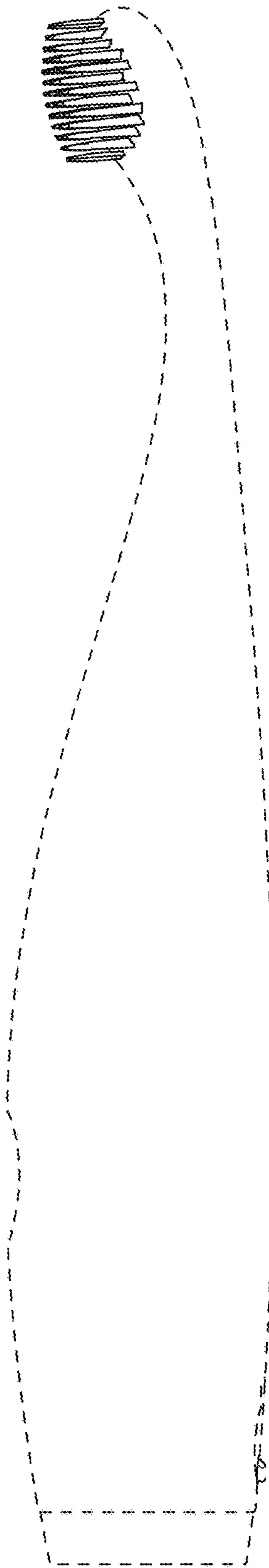
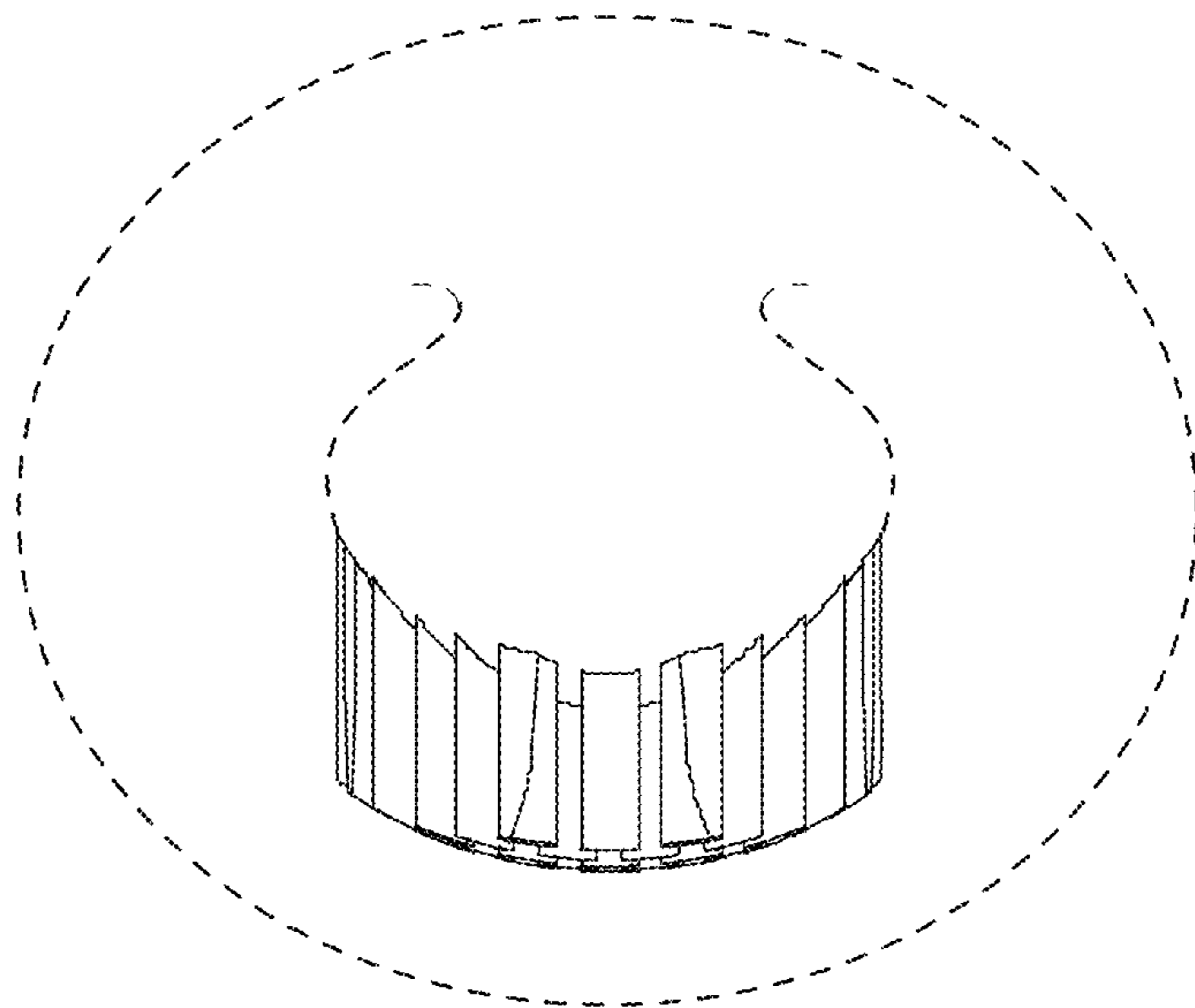

FIG. 11



**FIG. 12**



**FIG. 13**

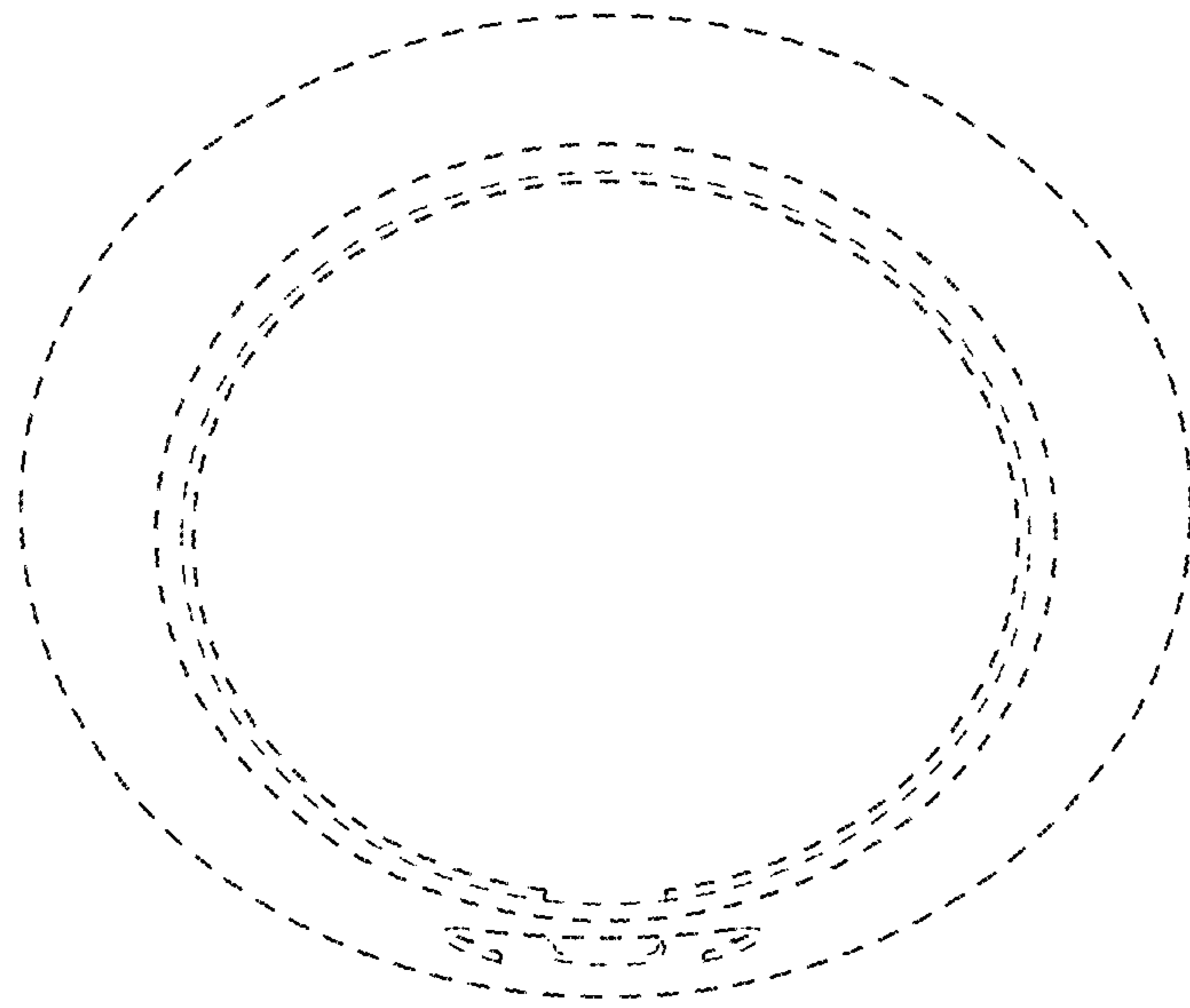

**FIG. 14**