



US00D811021S

(12) **United States Design Patent**  
**Myerson**

(10) **Patent No.:** **US D811,021 S**

(45) **Date of Patent:** **\*\* Feb. 20, 2018**

- (54) **PET LITTER SCOOP**
- (71) Applicant: **Maurice Myerson**, Atlanta, GA (US)
- (72) Inventor: **Maurice Myerson**, Atlanta, GA (US)
- (\*\*) Term: **15 Years**
- (21) Appl. No.: **29/548,777**
- (22) Filed: **Dec. 16, 2015**
- (51) **LOC (11) Cl.** ..... **30-99**
- (52) **U.S. Cl.**  
USPC ..... **D30/162**
- (58) **Field of Classification Search**  
USPC ..... D30/162, 161, 199; 119/867, 161, 166,  
119/174; D8/13, 10; D9/430;  
294/1.3-1.5, 19.1, 49, 50, 50.5, 55, 179,  
294/176, 180, 3, 7, 99.2, 177, 59, 57;  
209/418, 419; 15/257.1, 257.2, 1.7;  
210/464, 465, 470, 472; D7/692;  
D21/532; D32/74  
CPC ..... A01K 1/01; A01K 1/011; A01K 1/0128;  
A01K 1/0132; E01H 1/12; E01H 1/1206;  
E01H 2001/122; E01H 2001/1226; E01H  
2001/1233; E01H 2001/1246; E01H  
2001/126; E01H 2001/1266; E01H  
2001/1273; E01H 2001/128; B07B 1/00;  
B07B 1/005; B07B 1/02; E04H 4/1609;  
F24B 15/08  
See application file for complete search history.

(56) **References Cited**

**U.S. PATENT DOCUMENTS**

- 594,778 A \* 11/1897 Charles ..... A47L 13/52  
294/181
- 1,201,505 A \* 10/1916 Robson ..... A47L 13/52  
294/181
- 4,483,560 A \* 11/1984 Lordi ..... E01H 1/1206  
15/257.1
- D281,107 S \* 10/1985 Lordi ..... D30/162

- 5,662,366 A \* 9/1997 Fraske ..... A63B 47/02  
294/19.2
- 6,234,549 B1 \* 5/2001 Brownell ..... A01K 1/0114  
294/1.3
- 6,416,097 B1 \* 7/2002 O'Rourke ..... A01K 1/0114  
209/418
- 6,732,402 B1 \* 5/2004 Hsu ..... A47L 13/52  
15/257.6
- 7,523,973 B2 \* 4/2009 Lin ..... A01K 1/0114  
209/418
- D659,916 S \* 5/2012 Myerson ..... D30/162
- D675,493 S \* 2/2013 Cie La ..... D32/74
- 2003/0025344 A1 \* 2/2003 Schultice ..... E01H 5/02  
294/54.5

(Continued)

*Primary Examiner* — Susan Moon Lee

(74) *Attorney, Agent, or Firm* — Walter A. Rodgers

(57) **CLAIM**

The ornamental design for a pet litter scoop, as shown and described.

**DESCRIPTION**

FIG. 1 is a perspective view of a pet litter scoop showing my new design;  
 FIG. 2 is a front elevational view thereof, the rear being a mirror image thereof;  
 FIG. 3 is a left-side elevational view thereof;  
 FIG. 4 is a top plan view thereof;  
 FIG. 5 is a bottom plan view thereof;  
 FIG. 6 is a right-side elevation view thereof; and,  
 FIG. 7 is a perspective view of a second embodiment of the pet litter scoop.  
 The only difference in the second embodiment of the pet litter scoop is an increase in the number of scoop tines. All other aspects of the second embodiment of the pet litter scoop are the same as those of the first embodiment.  
 The broken lines shown represent unclaimed features of the pet litter scoop depicted for purposes of illustration and that form no part of the claimed design.

**1 Claim, 3 Drawing Sheets**

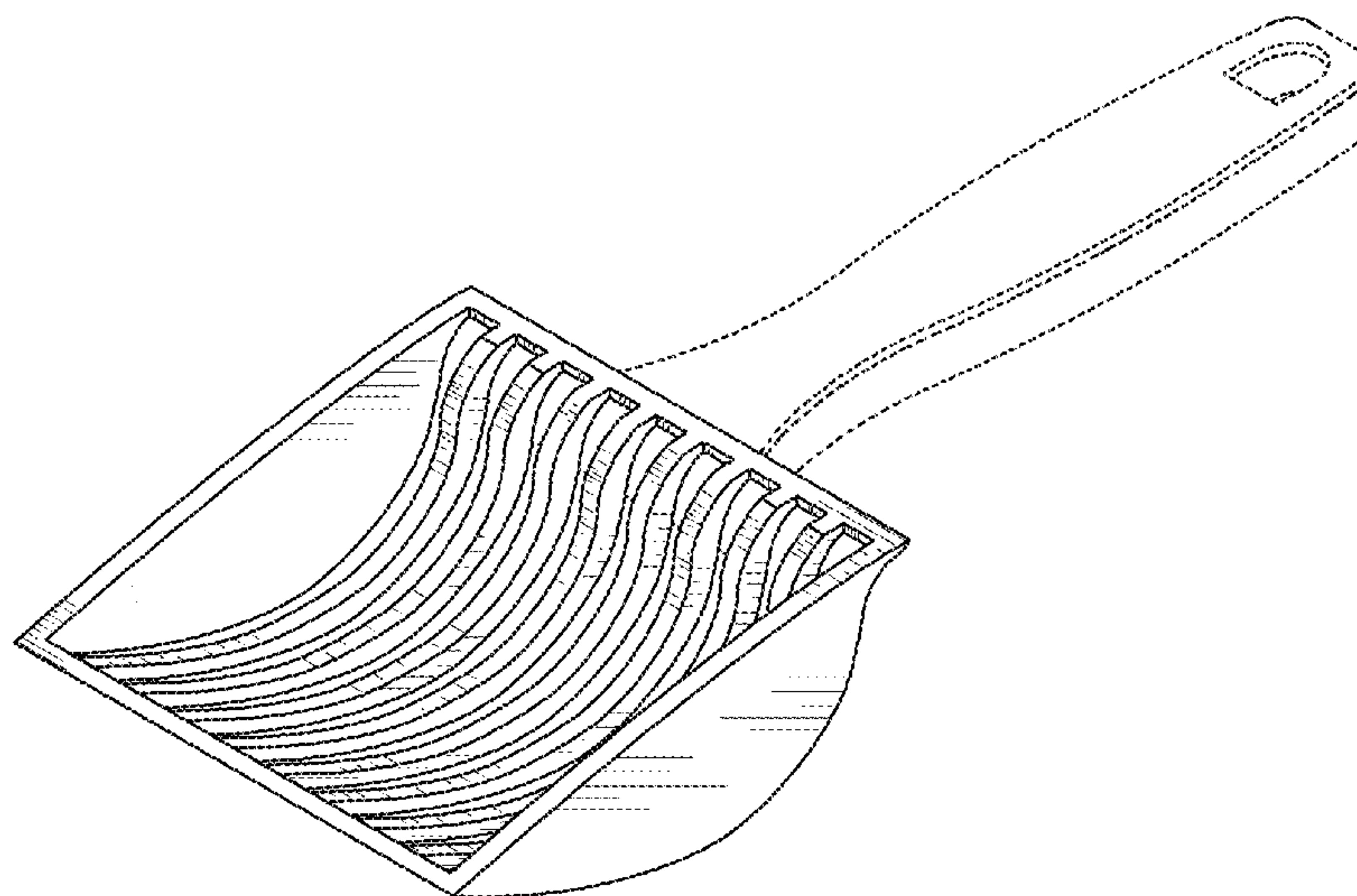

(56)

**References Cited**

U.S. PATENT DOCUMENTS

2004/0124646 A1\* 7/2004 Peko ..... A01K 23/005  
294/1.4  
2004/0227364 A1\* 11/2004 Pain ..... A01K 1/0114  
294/1.3  
2005/0173935 A1\* 8/2005 Pain ..... A01K 1/0114  
294/1.3  
2014/0070556 A1\* 3/2014 Price ..... A01B 1/02  
294/50.6  
2016/0295829 A1\* 10/2016 Mertz ..... A01K 1/0114

\* cited by examiner

Fig 1

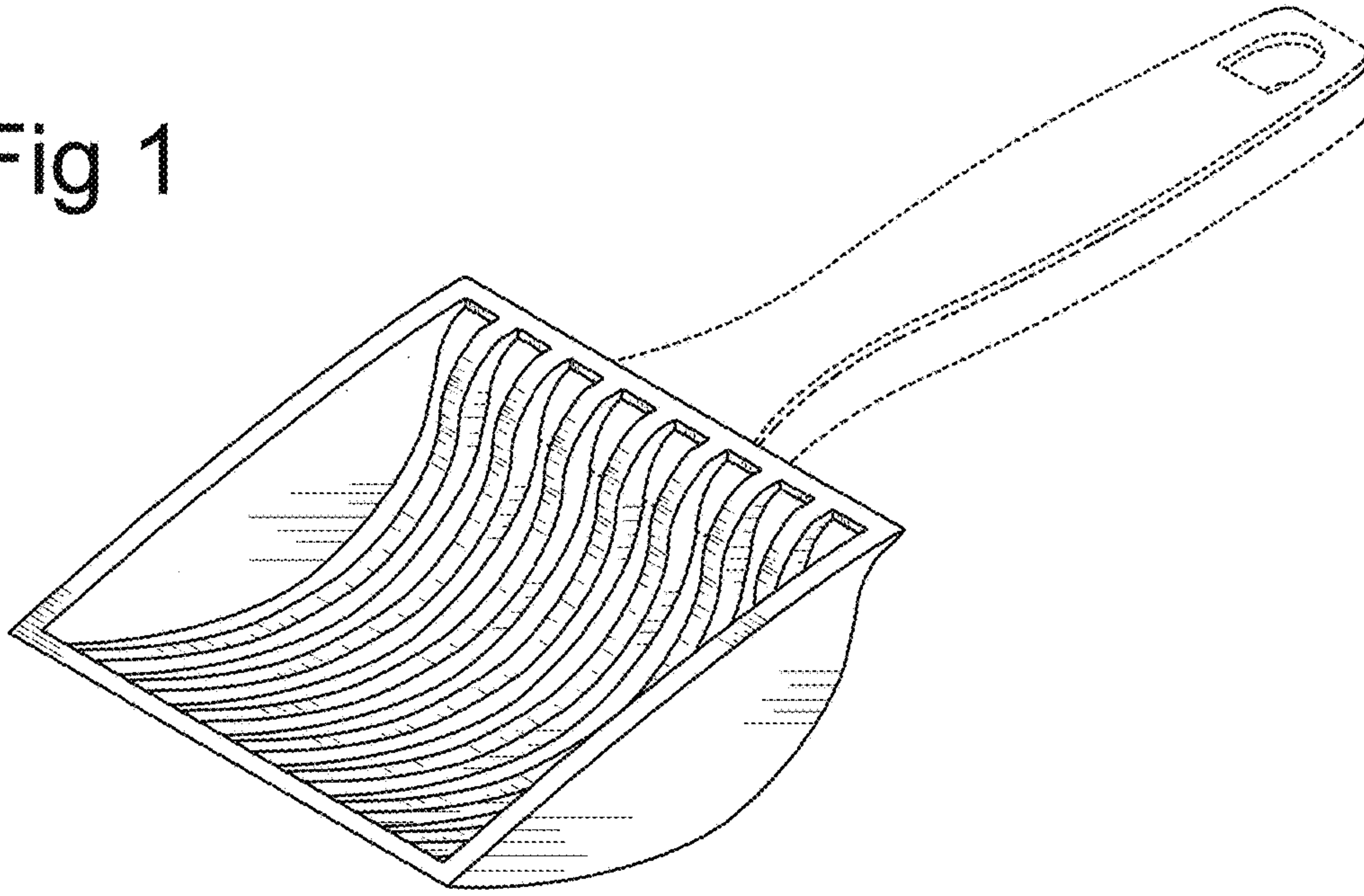

Fig 2

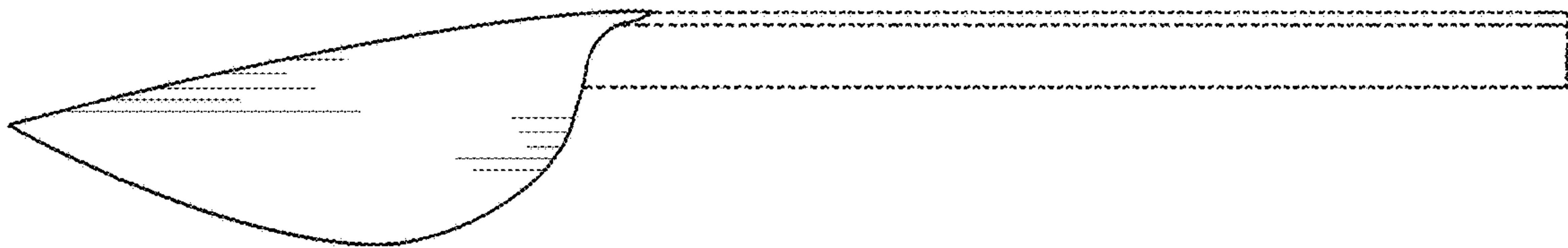

Fig 3

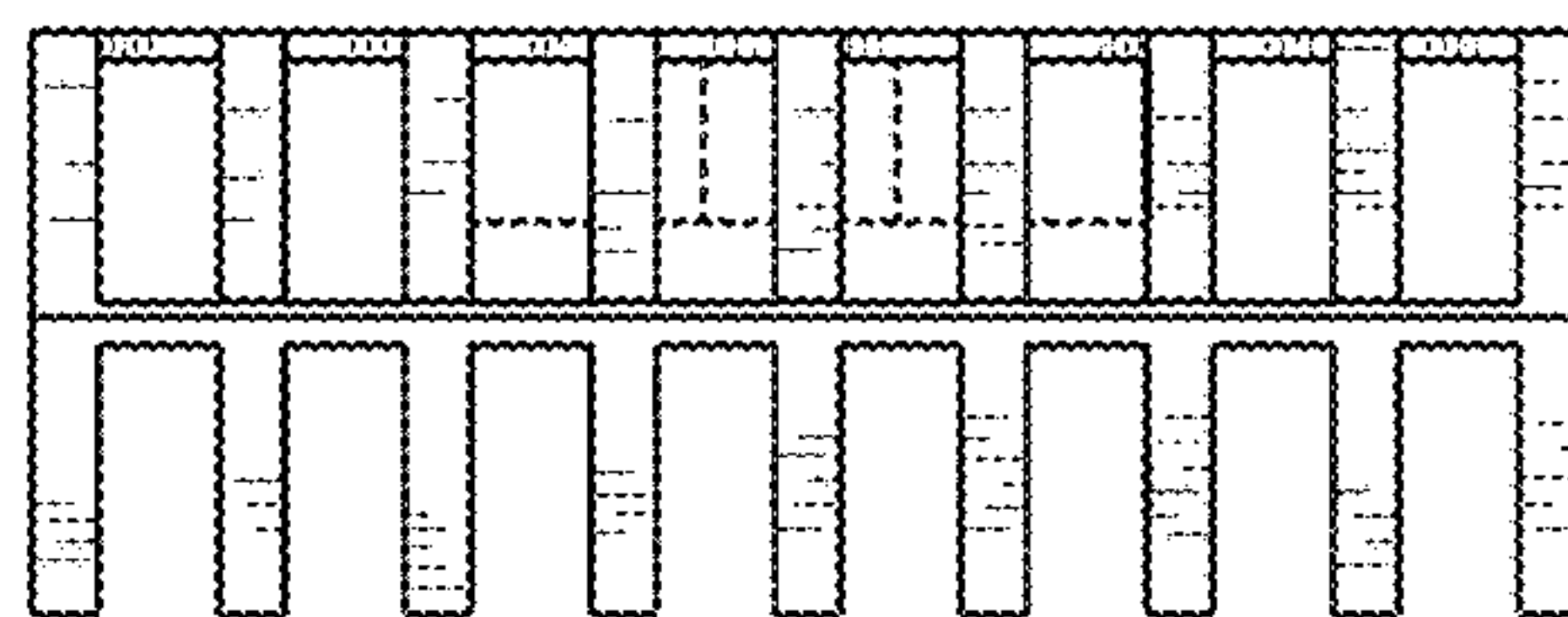

Fig 4

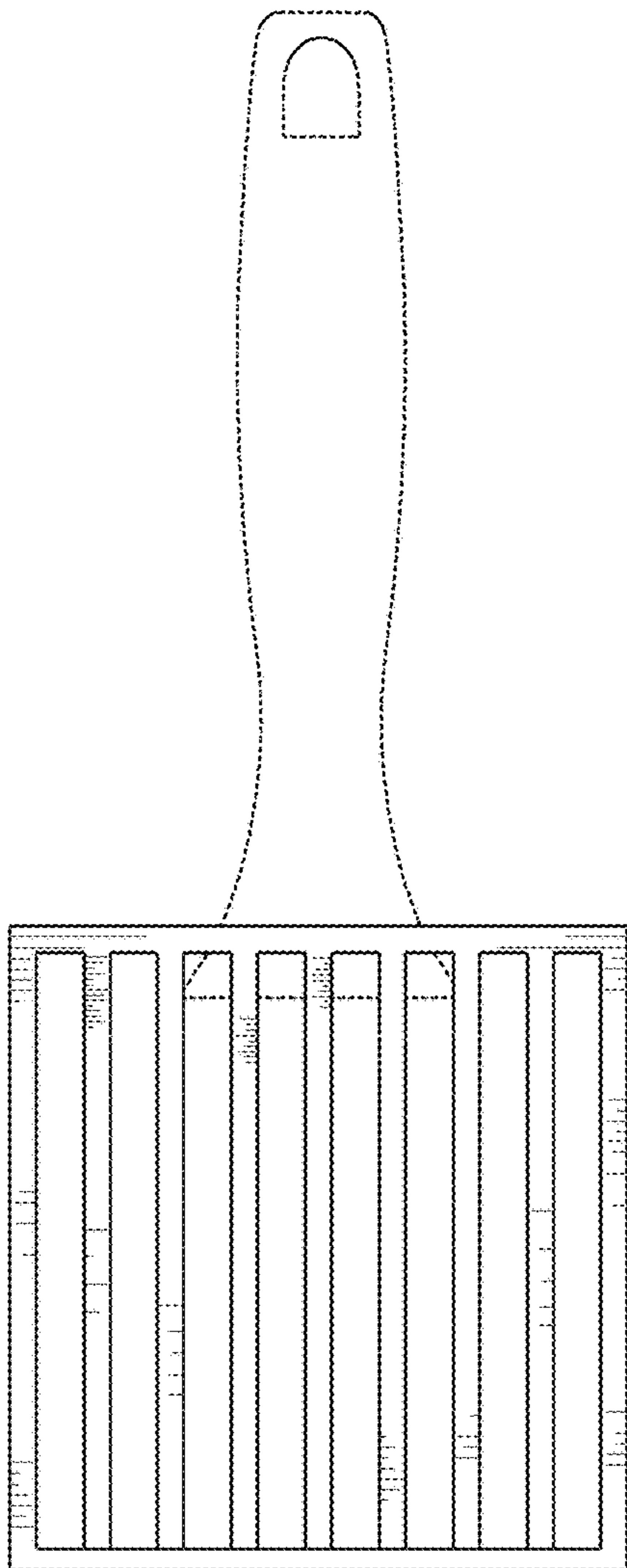

Fig 5

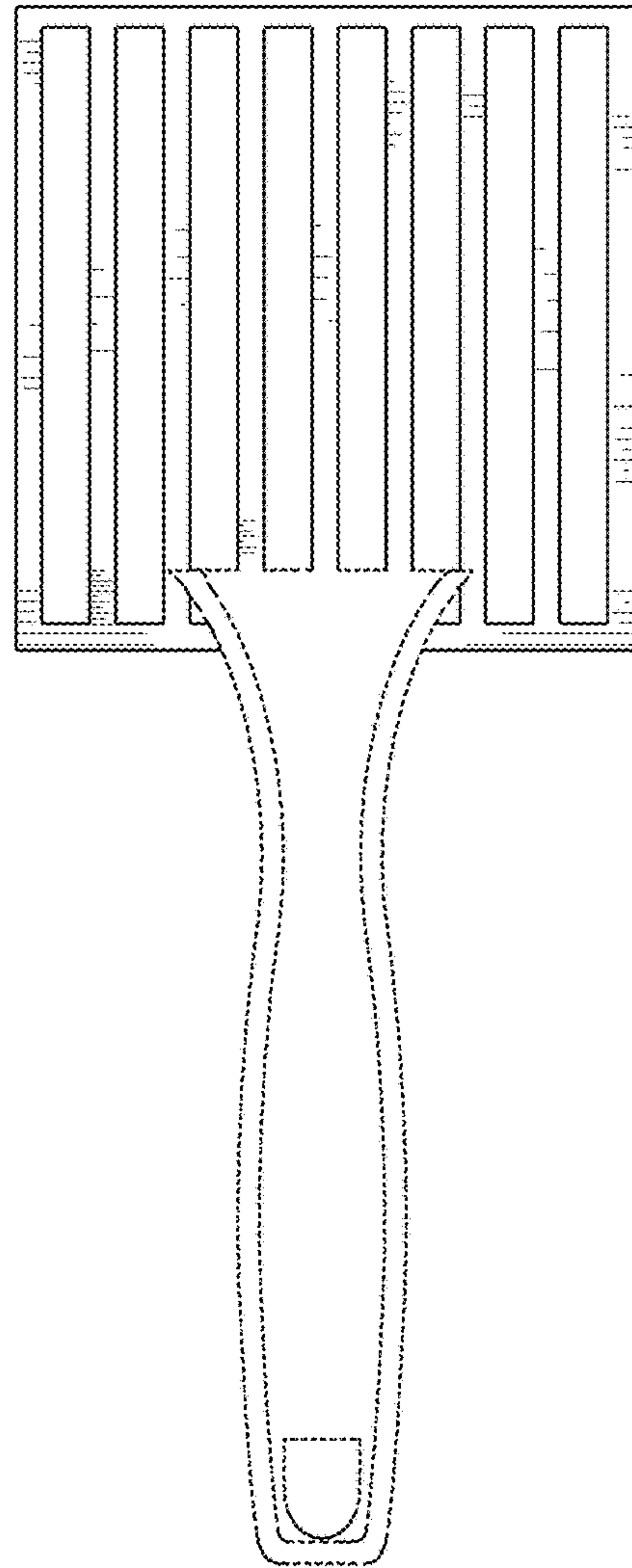



Fig 6

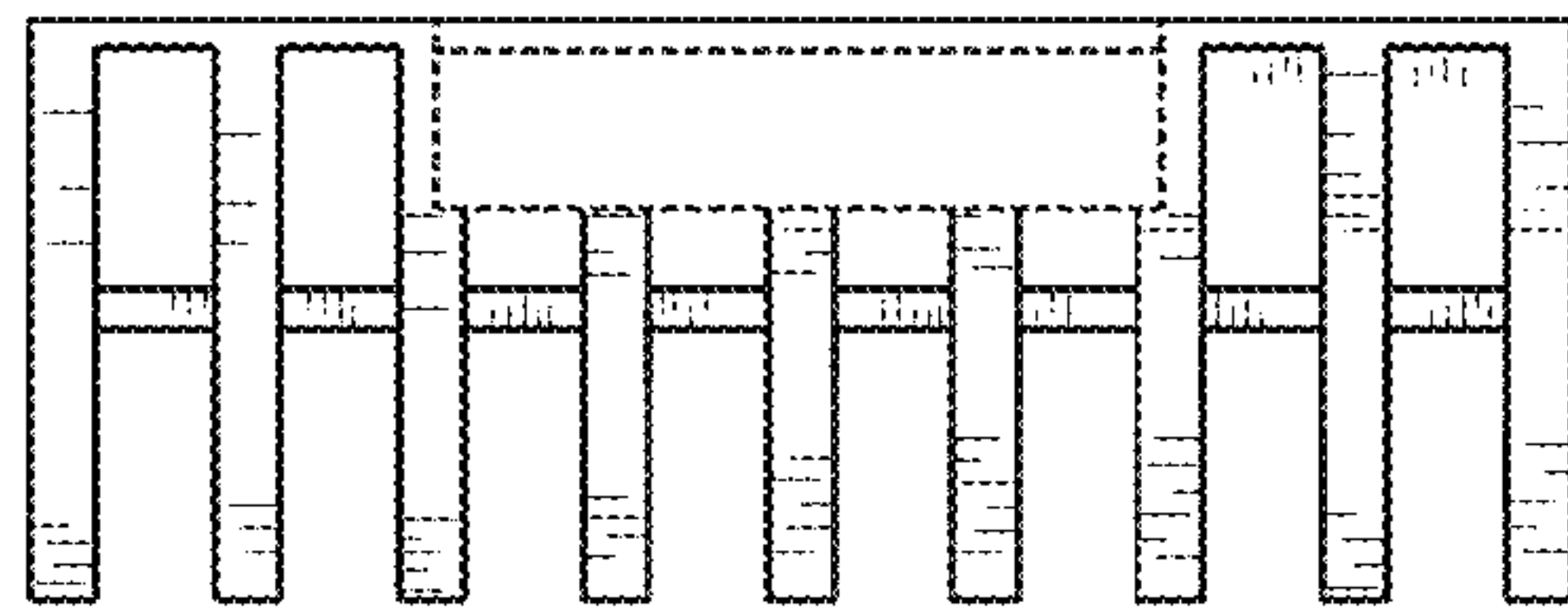

Fig 7

