



US00D810940S

(12) **United States Design Patent**
Goldberg

(10) **Patent No.:** **US D810,940 S**

(45) **Date of Patent:** **** Feb. 20, 2018**

(54) **IMPLANT**

(71) Applicant: **CATALYST ORTHOSCIENCE INC.**,
Naples, FL (US)

(72) Inventor: **Steven S. Goldberg**, Naples, FL (US)

(73) Assignee: **CATALYST ORTHOSCIENCE INC.**,
Naples, FL (US)

(**) Term: **15 Years**

(21) Appl. No.: **29/568,298**

(22) Filed: **Jun. 16, 2016**

Related U.S. Application Data

(63) Continuation of application No. 29/524,099, filed on Apr. 16, 2015, now Pat. No. Des. 759,819, which is a continuation of application No. 29/468,456, filed on Sep. 30, 2013, now Pat. No. Des. 730,522, which is a continuation of application No. 14/042,258, filed on Sep. 30, 2013, now Pat. No. 9,775,716.

(51) **LOC (11) Cl.** **24-00**

(52) **U.S. Cl.**
USPC **D24/155**

(58) **Field of Classification Search**
USPC D24/171, 155-157, 147, 33
CPC . A61F 2/4081; A61F 2/40; A61F 2002/30332
See application file for complete search history.

(56) **References Cited**

U.S. PATENT DOCUMENTS

4,106,130 A	8/1978	Scales	
4,206,517 A	6/1980	Pappas	
4,550,450 A	11/1985	Kinnett	
4,865,605 A *	9/1989	Dines	A61F 2/40 623/19.14
4,964,865 A *	10/1990	Burkhead	A61F 2/40 623/19.11

4,986,833 A	1/1991	Worland	
5,030,219 A *	7/1991	Matsen, III	A61B 17/1624 606/53
5,032,132 A *	7/1991	Matsen, III	A61F 2/4081 623/19.11
5,383,936 A	1/1995	Kubein Meesenburg	
5,489,309 A	2/1996	Lackey	
5,489,310 A *	2/1996	Mikhail	A61B 17/1684 623/19.11
5,702,447 A	12/1997	Walch	
5,723,018 A	3/1998	Cyprien	

(Continued)

FOREIGN PATENT DOCUMENTS

AU	2013209336	2/2014
CA	2821529	1/2014

(Continued)

Primary Examiner — Charles Hanson

(74) *Attorney, Agent, or Firm* — Maywood IP Law; G. Jo Hays; David W. Meibos

(57) **CLAIM**

The ornamental design for an implant, as shown and described.

DESCRIPTION

FIG. 1 is a back left perspective view of an implant; FIG. 2 is a back right perspective view of the implant; FIG. 3 is a front left perspective view of the implant; FIG. 4 is a front view of the implant; FIG. 5 is a back view of the implant; FIG. 6 is a left view of the implant; FIG. 7 is a right view of the implant; FIG. 8 is a bottom view of the implant; and, FIG. 9 is a top view of the implant.

In the drawings, the broken lines depict environmental subject matter only and form no part of the claimed design.

1 Claim, 8 Drawing Sheets

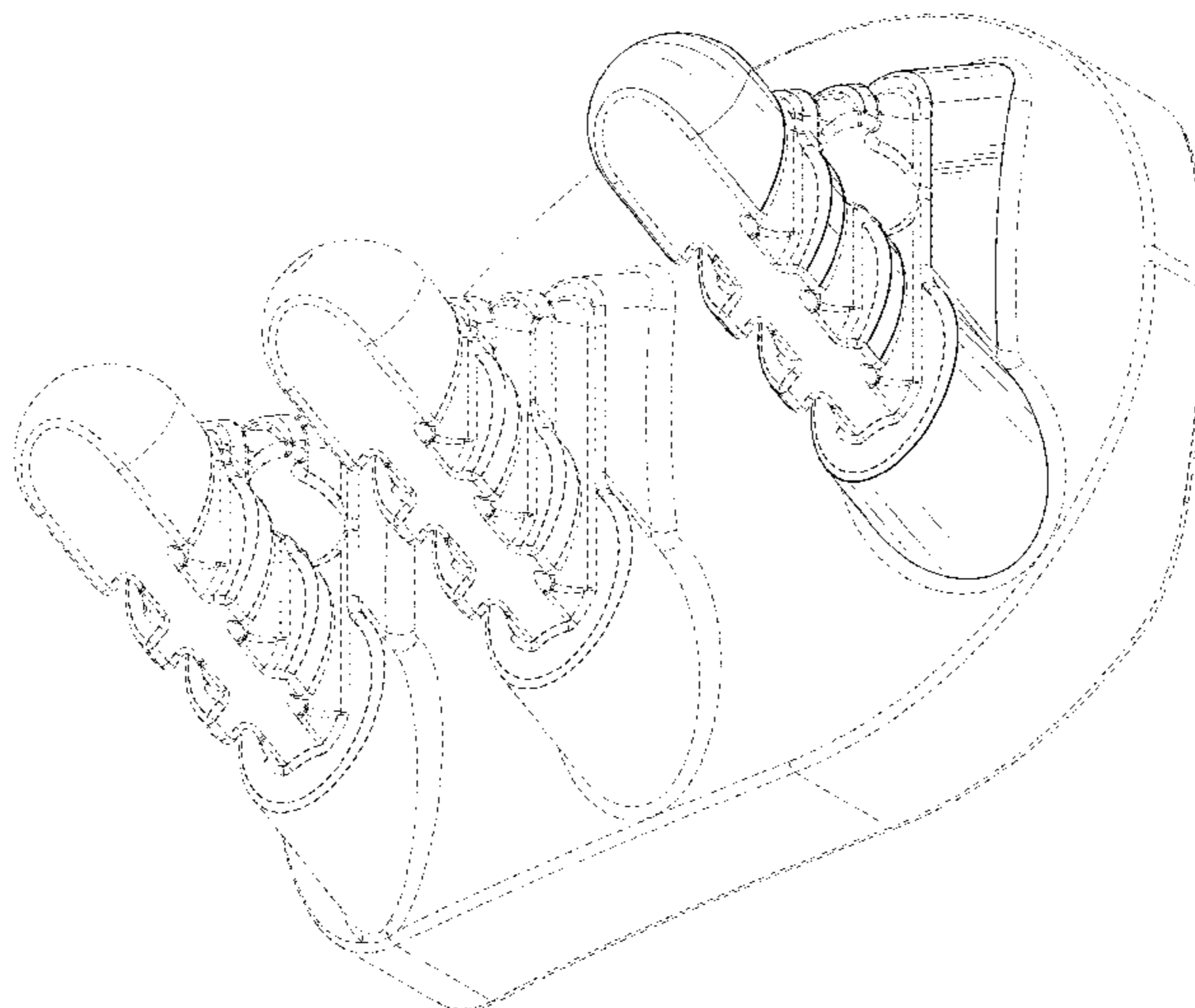

US D810,940 S

(56)

References Cited

U.S. PATENT DOCUMENTS

5,769,856	A	6/1998	Dong	
5,800,551	A	9/1998	Williamson	
5,814,049	A	9/1998	Pratt	
5,919,195	A	7/1999	Wilson	
5,928,285	A	7/1999	Bigliani	
5,944,758	A	8/1999	Mansat	
5,976,144	A	11/1999	Fishbein	
6,129,732	A	10/2000	Lechot	
6,245,074	B1	6/2001	Allard	
6,364,910	B1	4/2002	Shultz	
6,379,386	B1	4/2002	Resch	
6,406,495	B1 *	6/2002	Schoch	A61F 2/4081 623/19.11
6,475,221	B1	11/2002	White	
6,673,115	B2	1/2004	Resch	
6,679,916	B1	1/2004	Frankle	
6,783,549	B1	8/2004	Stone	
6,875,234	B2	4/2005	Lipman	
6,911,047	B2	6/2005	Rockwood, Jr.	
7,008,430	B2	3/2006	Dong	
7,048,740	B2	5/2006	White	
7,160,328	B2	1/2007	Rockwood, Jr.	
7,204,854	B2 *	4/2007	Guederian	A61B 17/864 623/19.11
7,217,272	B2	5/2007	Salyer	
7,294,149	B2	11/2007	Hozack	
7,329,284	B2	2/2008	Maroney	
7,588,572	B2	9/2009	White	
7,621,962	B2	11/2009	Lakin	
7,670,382	B2	3/2010	Parrott	
7,780,669	B2	8/2010	Lechot	
7,815,685	B2	10/2010	Farrar	
7,867,234	B2	1/2011	Collazo	
8,007,538	B2	8/2011	Gunther	
8,038,719	B2	10/2011	Gunther	
8,048,161	B2	11/2011	Guederian	
8,080,063	B2	12/2011	Ferrand	
8,157,866	B2	4/2012	Winslow	
8,308,809	B2	11/2012	Bishop	
8,425,614	B2	4/2013	Winslow	
8,444,646	B2	5/2013	Long	
8,465,548	B2	6/2013	Long	
8,475,460	B1	7/2013	Roger	
8,480,674	B1	7/2013	Roger	
8,540,778	B2	9/2013	Rhodes	
8,591,592	B2	11/2013	Dreyfuss	
8,673,015	B2	3/2014	Maroney	
8,764,836	B2	7/2014	De Wilde	
8,778,028	B2	7/2014	Gunther	
8,870,962	B2	10/2014	Roche	
8,876,907	B2	11/2014	Baptista	
8,974,537	B2	3/2015	Dreyfuss	
D730,522	S	5/2015	Goldberg	
9,119,643	B2	9/2015	Winslow	
9,180,016	B2	11/2015	Maroney	
9,233,003	B2	1/2016	Roche	
9,237,894	B2	1/2016	Hernandez	
9,283,076	B2	3/2016	Sikora	
9,351,844	B2	5/2016	Walch	
D759,819	S	6/2016	Goldberg	
9,370,428	B2	6/2016	Winslow	
9,433,507	B2	9/2016	Reubelt	
9,474,619	B2	10/2016	Reubelt	
9,610,166	B2	4/2017	Gunther	
2002/0082702	A1	6/2002	Resch	
2003/0187449	A1	10/2003	McCleary	
2003/0204263	A1	10/2003	Justin	
2005/0049709	A1	3/2005	Tornier	
2005/0222572	A1	10/2005	Chana	
2006/0074430	A1 *	4/2006	Deffenbaugh	A61B 17/1617 606/87
2006/0094958	A1	5/2006	Marquart	
2006/0111787	A1	5/2006	Bailie	
2007/0055380	A1 *	3/2007	Berelsman	A61F 2/4081 623/19.11

2007/0142917	A1 *	6/2007	Roche	A61F 2/4081 623/19.11
2007/0219637	A1 *	9/2007	Berelsman	A61F 2/4081 623/19.11
2007/0219638	A1	9/2007	Jones	
2007/0225817	A1 *	9/2007	Reubelt	A61F 2/4081 623/19.11
2007/0225818	A1	9/2007	Reubelt	
2008/0109000	A1	5/2008	Maroney	
2008/0147070	A1	6/2008	Michel	
2008/0287952	A1	11/2008	Mcminn	
2009/0005798	A1	1/2009	Brunner	
2009/0018664	A1	1/2009	Kropf	
2009/0125113	A1 *	5/2009	Guederian	A61F 2/4081 623/19.11
2009/0192621	A1	7/2009	Winslow	
2009/0226068	A1	9/2009	Fitz	
2010/0087876	A1	4/2010	Gunther	
2010/0087877	A1	4/2010	Gunther	
2010/0161065	A1 *	6/2010	Williams, Jr.	A61F 2/4081 623/19.11
2010/0241235	A1	9/2010	Basamania	
2010/0268239	A1	10/2010	Sikora	
2011/0035013	A1 *	2/2011	Winslow	A61F 2/4003 623/19.13
2011/0106266	A1	5/2011	Schwyzler	
2011/0230972	A1	9/2011	Katrana	
2011/0276144	A1	11/2011	Wirth	
2012/0130498	A1	5/2012	Long	
2012/0130500	A1	5/2012	Maroney	
2012/0209392	A1	8/2012	Angibaud	
2012/0239156	A1	9/2012	De Wilde	
2012/0310360	A1	12/2012	Parrott	
2013/0024000	A1	1/2013	Bojarski	
2013/0090737	A1	4/2013	Flaherty	
2013/0144393	A1	6/2013	Mutchler	
2013/0166033	A1	6/2013	Gunther	
2013/0309030	A1	11/2013	Winslow	
2014/0031945	A1 *	1/2014	Baptista	A61F 2/4081 623/19.11
2014/0257495	A1	9/2014	Goldberg	
2015/0119891	A1	4/2015	Goldberg	
2015/0320567	A1	11/2015	Terrill	
2016/0089164	A1	3/2016	Winslow	
2016/0095607	A1	4/2016	Hernandez	
2016/0242921	A1	8/2016	Walch	
2016/0287266	A1	10/2016	Sikora	
2017/0014238	A1	1/2017	Reubelt	
2017/0042689	A1	2/2017	Goldberg	
2017/0239058	A1	8/2017	Goldberg	

FOREIGN PATENT DOCUMENTS

CN	101442961	11/2012
CN	102014800	4/2014
CN	105377195	3/2016
DE	10130796	1/2003
DE	10134511	2/2003
EP	1518519	3/2005
EP	1159939	7/2005
EP	2238949	10/2010
EP	2446859	5/2012
EP	2559406	2/2013
EP	2689751	1/2014
EP	2967892	1/2016
FR	2825263	12/2002
FR	2836821	5/2004
GB	2308068	9/1999
WO	WO1998015241	4/1998
WO	WO2000018335	4/2000
WO	WO2002017822	3/2002
WO	WO2006110896	10/2006
WO	WO2007109800	9/2007
WO	WO2009108591	9/2009
WO	WO2012030794	3/2012
WO	WO2013020026	2/2013

(56)

References Cited

FOREIGN PATENT DOCUMENTS

WO	WO2014005644	1/2014
WO	WO2014164265	10/2014
WO	WO2015106136	7/2015

* cited by examiner

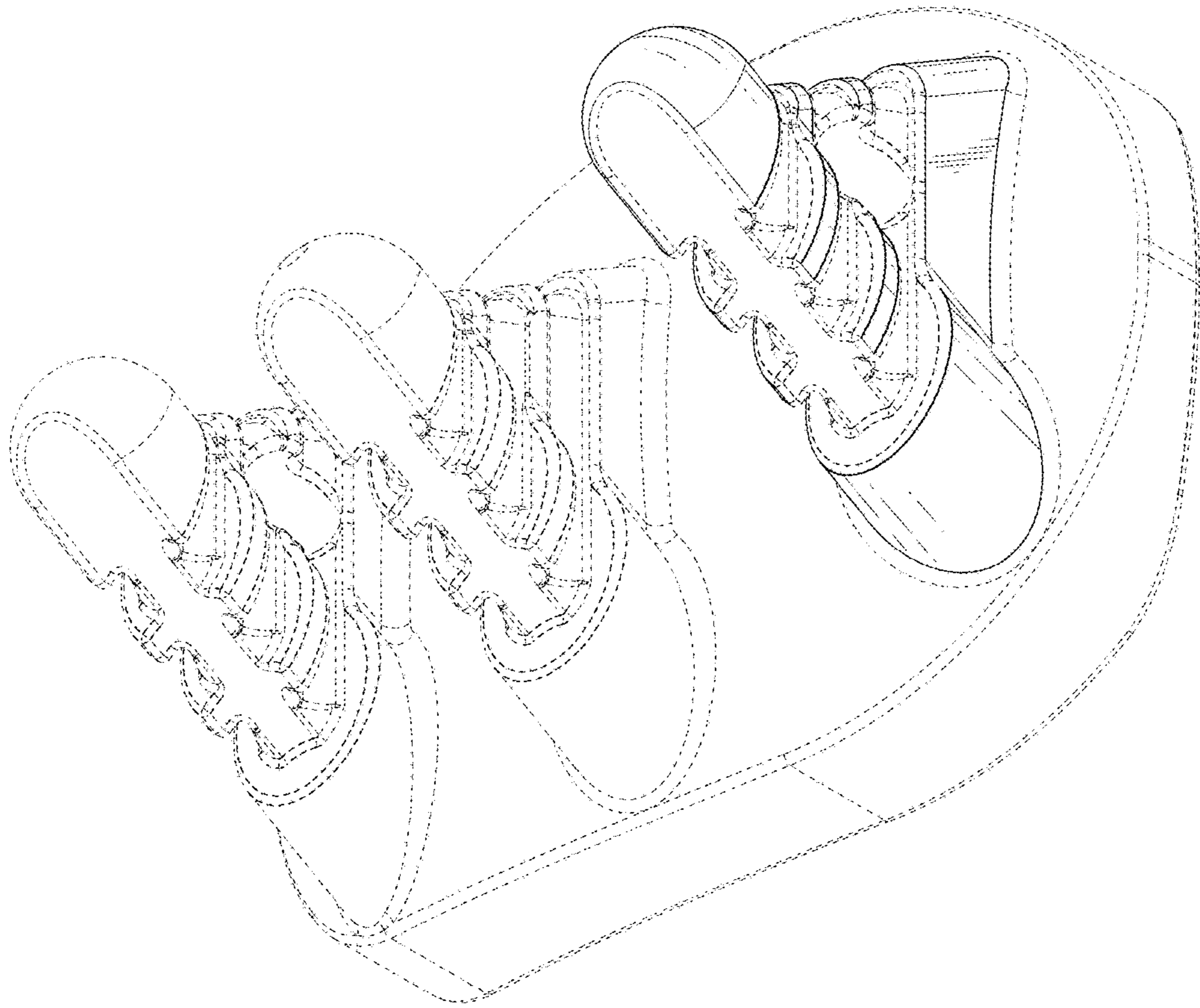

FIG. 1

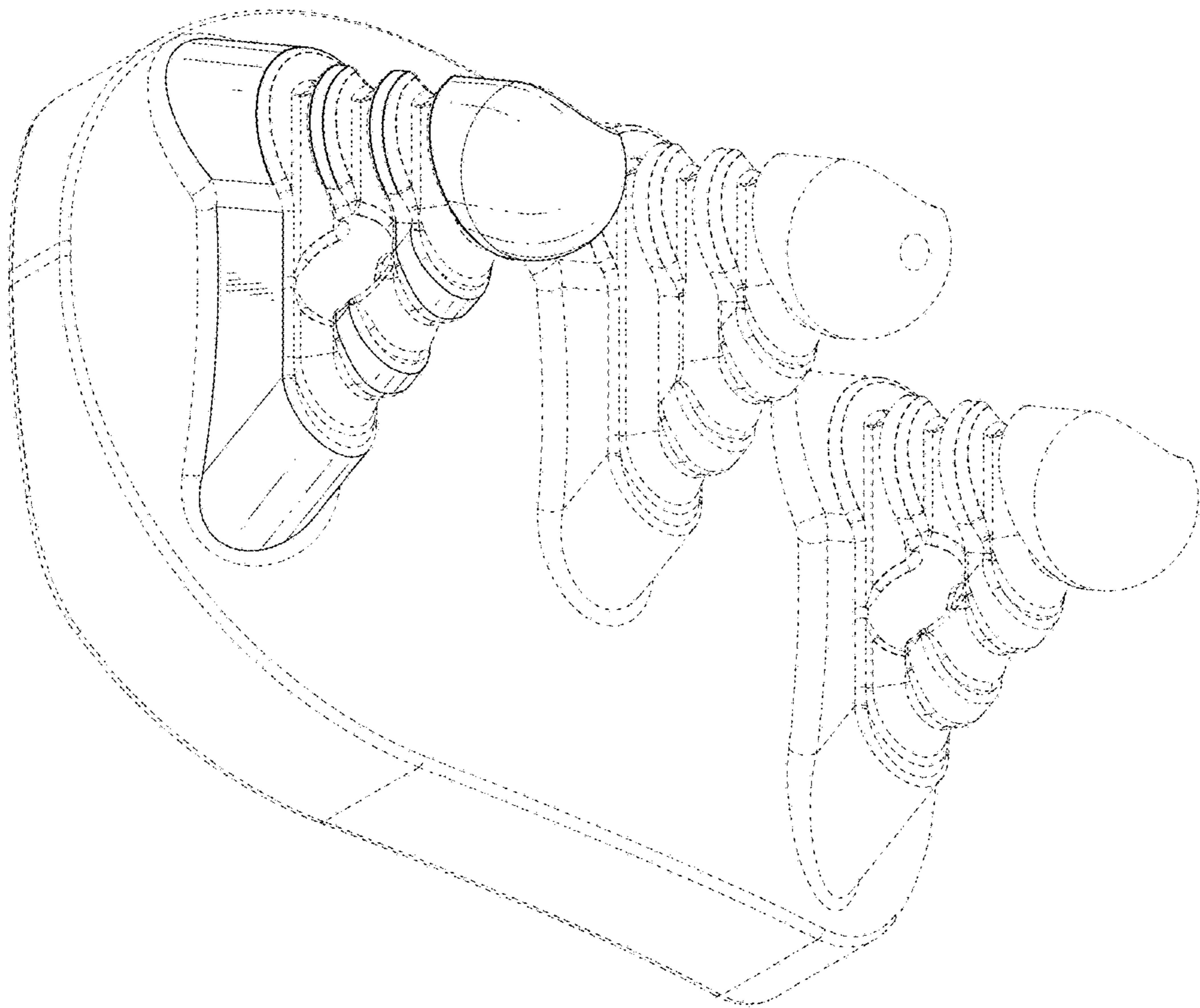

FIG. 2

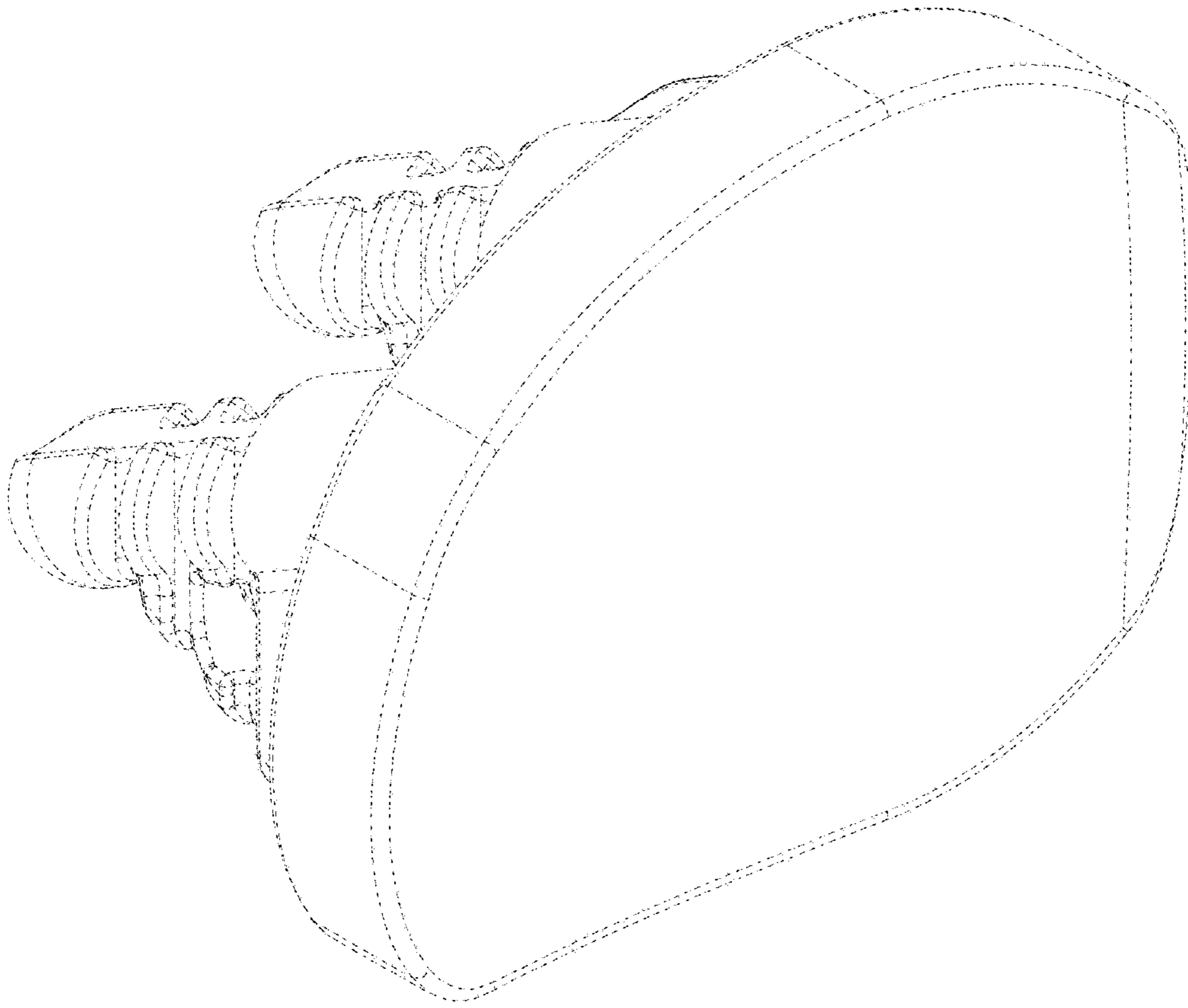

FIG. 3

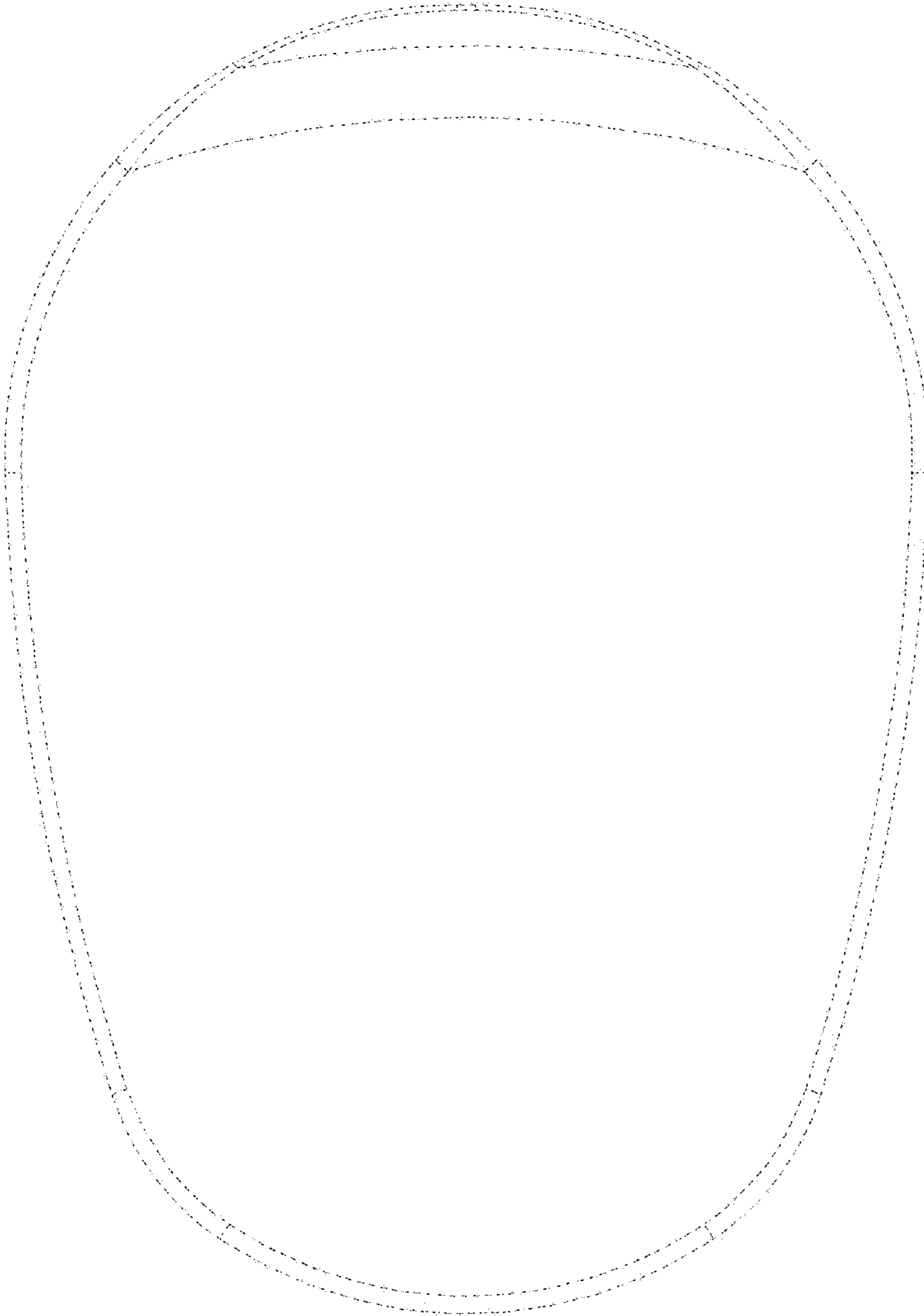

FIG. 4

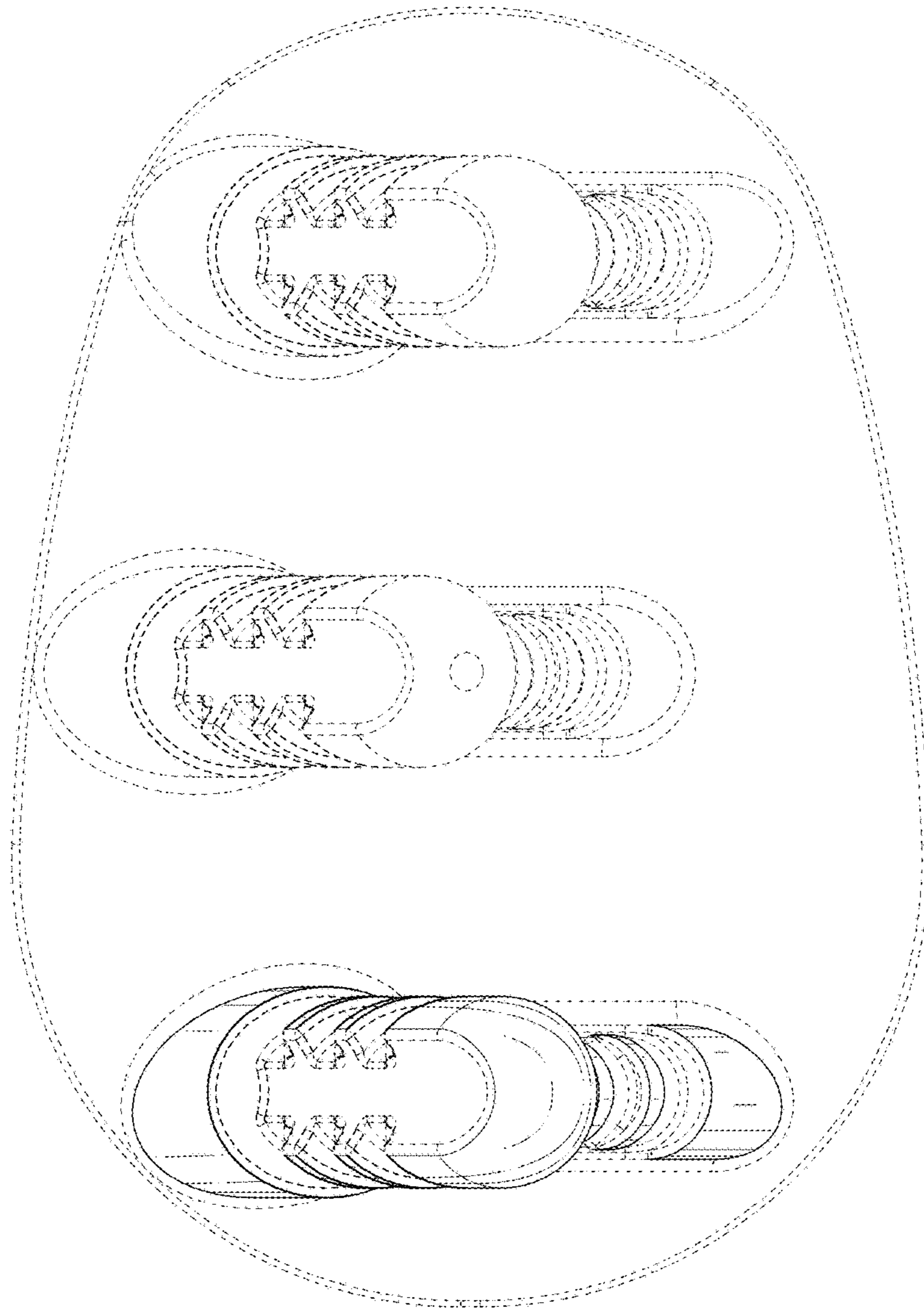

FIG. 5

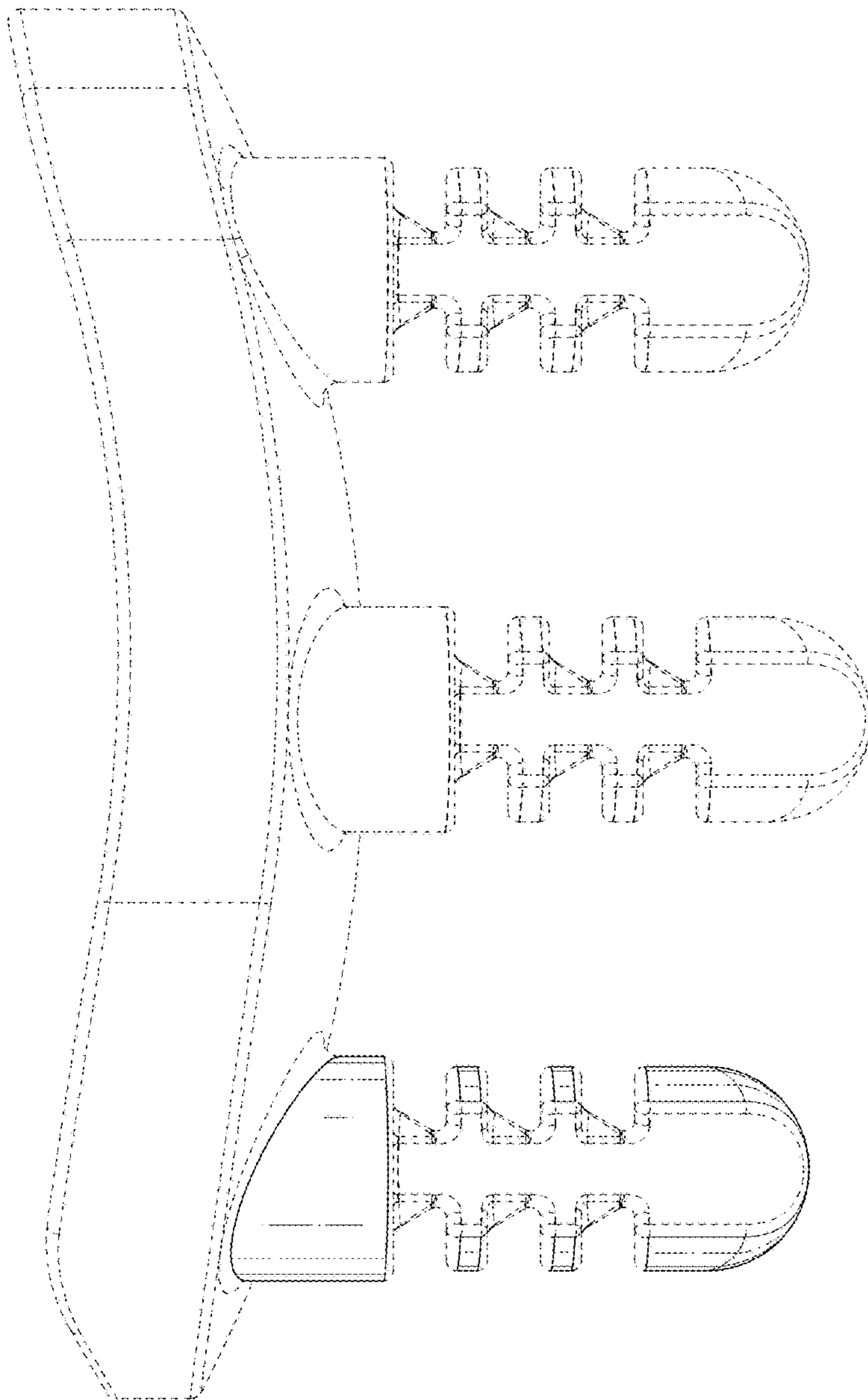

FIG. 6

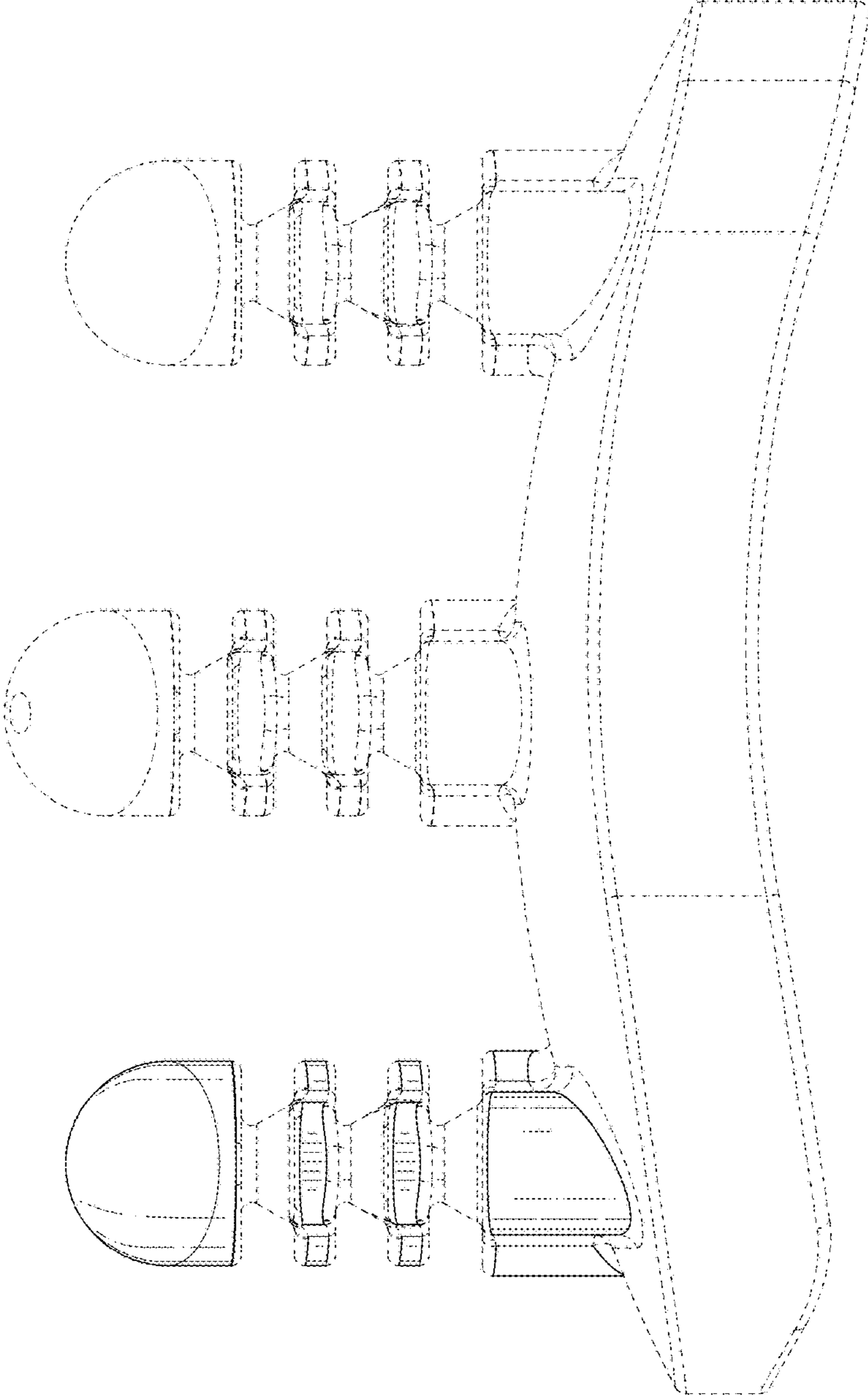

FIG. 7

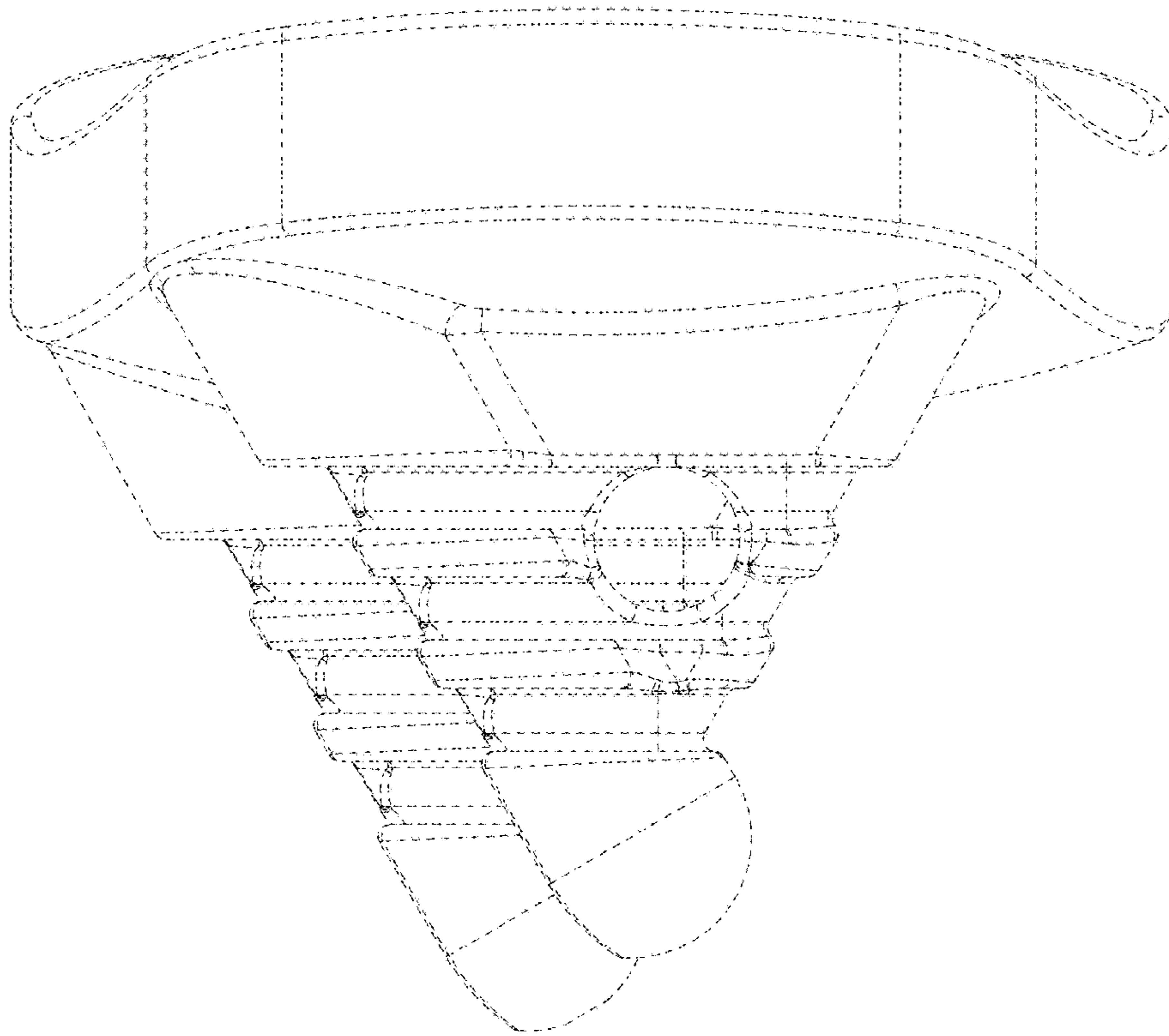

FIG. 9

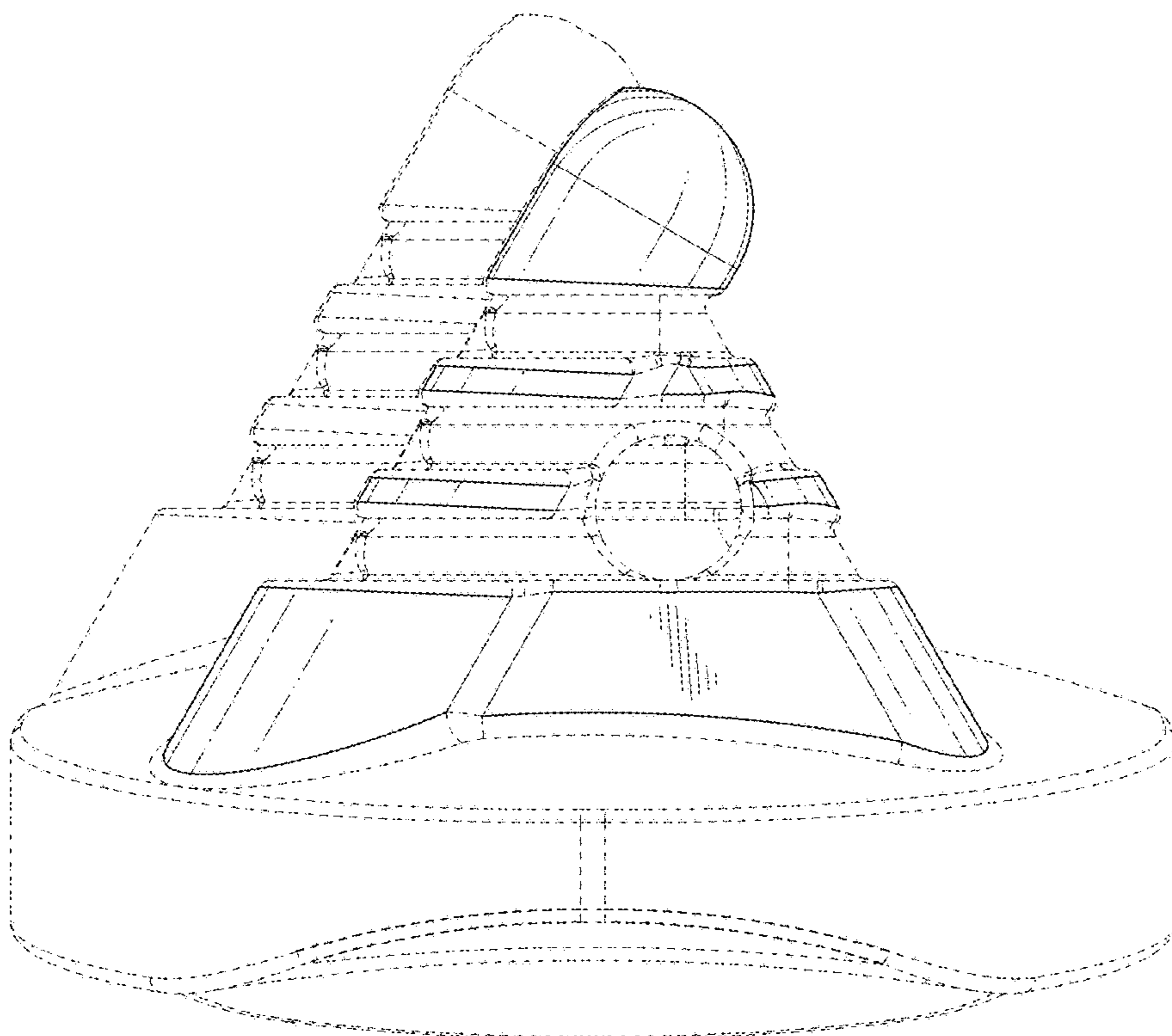

FIG. 8