



US00D810937S

(12) **United States Design Patent**  
**Wilkinson**

(10) **Patent No.:** **US D810,937 S**

(45) **Date of Patent:** **\*\* Feb. 20, 2018**

- (54) **INSERT FOR DENTAL INSTRUMENTS**
- (71) Applicant: **DENTSPLY SIRONA Inc.**, York, PA (US)
- (72) Inventor: **Kevin Wilkinson**, Bixby, OK (US)
- (73) Assignee: **Dentsply Sirona Inc.**, York, PA (US)
- (\*\*) Term: **15 Years**
- (21) Appl. No.: **29/590,038**
- (22) Filed: **Jan. 6, 2017**

- 2,807,361 A \* 9/1957 Junkin ..... B65D 5/504  
206/553
- 3,591,032 A \* 7/1971 Baxter ..... B65D 1/36  
206/564
- D221,380 S \* 8/1971 Chasen et al. .... D24/177
- D234,404 S \* 2/1975 Merrill ..... D24/230
- D240,537 S \* 7/1976 Sronce ..... D24/230

(Continued)

*Primary Examiner* — Wan Laymon

(74) *Attorney, Agent, or Firm* — David A. Zdurne;  
Douglas J. Hura; Leana Levin

(57) **CLAIM**

The ornamental design for an insert for dental instruments, as shown and described.

**DESCRIPTION**

FIG. 1 is a top perspective view of an insert for dental instruments of the present invention;  
 FIG. 2 is a top view of the insert shown in FIG. 1;  
 FIG. 3 is a bottom view of the insert shown in FIG. 1;  
 FIG. 4 is a left side view of the insert shown in FIG. 1;  
 FIG. 5 is a right side view of the insert shown in FIG. 1;  
 FIG. 6 is a back view of the insert shown in FIG. 1;  
 FIG. 7 is a front view of the insert shown in FIG. 1;  
 FIG. 8 is a top perspective view of another insert for dental instruments of the present invention;  
 FIG. 9 is a top view of the insert shown in FIG. 8;  
 FIG. 10 is a bottom view of the insert shown in FIG. 8;  
 FIG. 11 is a left side view of the insert shown in FIG. 8;  
 FIG. 12 is a right side view of the insert shown in FIG. 8;  
 FIG. 13 is a back view of the insert shown in FIG. 8; and,  
 FIG. 14 is a front view of the insert shown in FIG. 8.

The broken lines immediately adjacent the claimed areas represent the bounds of the claim, and all other broken lines are included for the purpose of illustrating portions of the present invention that form no part of the claimed design. None of the broken lines form part of the claimed design.

**1 Claim, 6 Drawing Sheets**

**Related U.S. Application Data**

- (62) Division of application No. 29/530,758, filed on Jun. 19, 2015, now abandoned.
- (51) **LOC (11) Cl.** ..... **24-02**
- (52) **U.S. Cl.**  
USPC ..... **D24/152**
- (58) **Field of Classification Search**  
USPC ..... D24/152, 156, 176–177, 127–128, 221,  
D24/224–232; D3/203.01, 203.3, 203.6,  
D3/272; D9/420, 433; D19/85, 100;  
206/363, 366, 370, 559–564  
CPC ..... B65D 71/72; B65D 71/70; B65D  
5/503–5/504; B65D 5/5038  
See application file for complete search history.

(56) **References Cited**

**U.S. PATENT DOCUMENTS**

- 585,713 A \* 7/1897 Smith ..... A61B 50/33  
206/370
- 746,999 A \* 12/1903 Schmitz ..... A61B 50/33  
206/370
- D60,340 S \* 2/1922 Grier ..... D24/230
- 1,906,031 A \* 4/1933 Wilmarth ..... B65D 5/504  
206/562

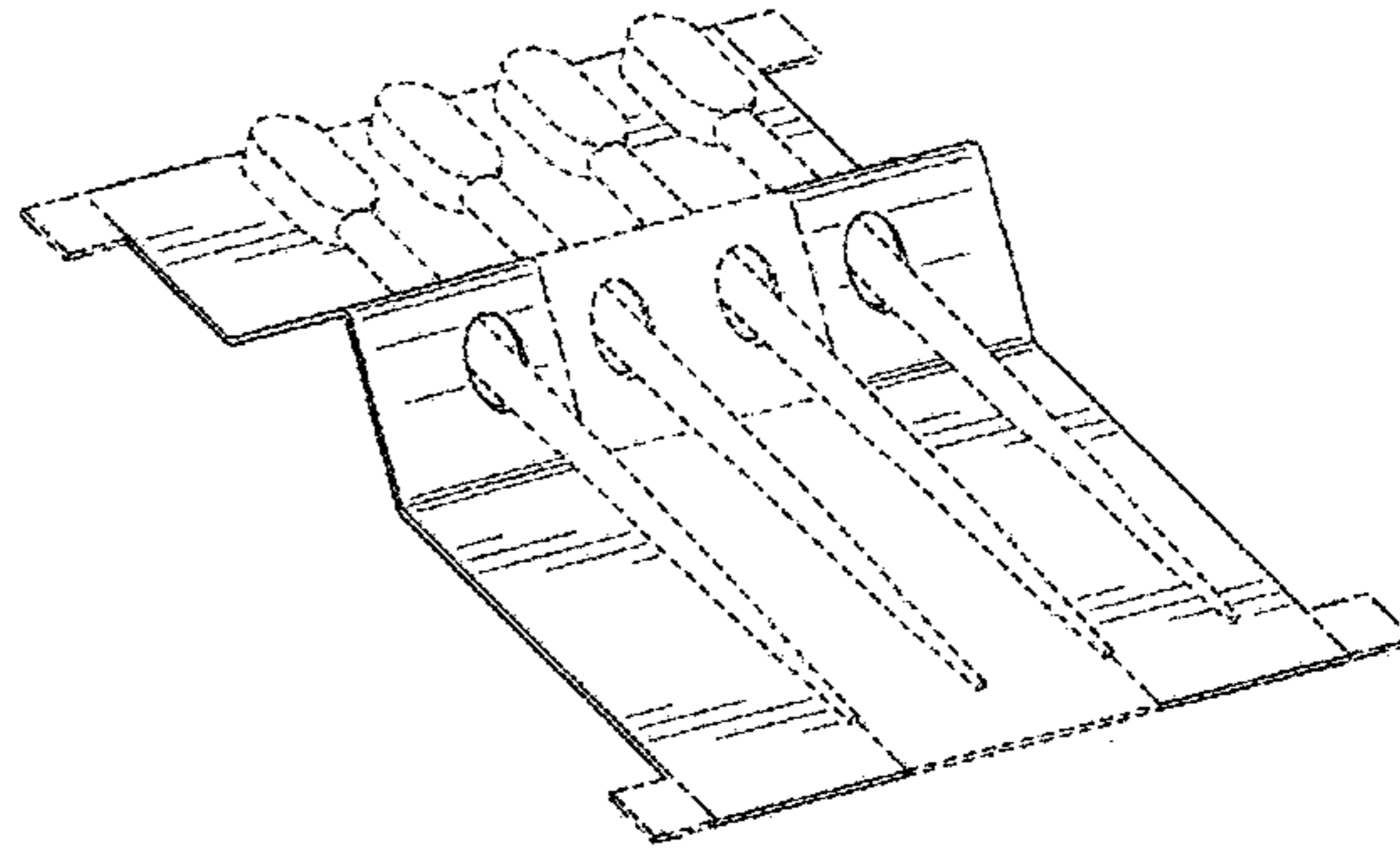
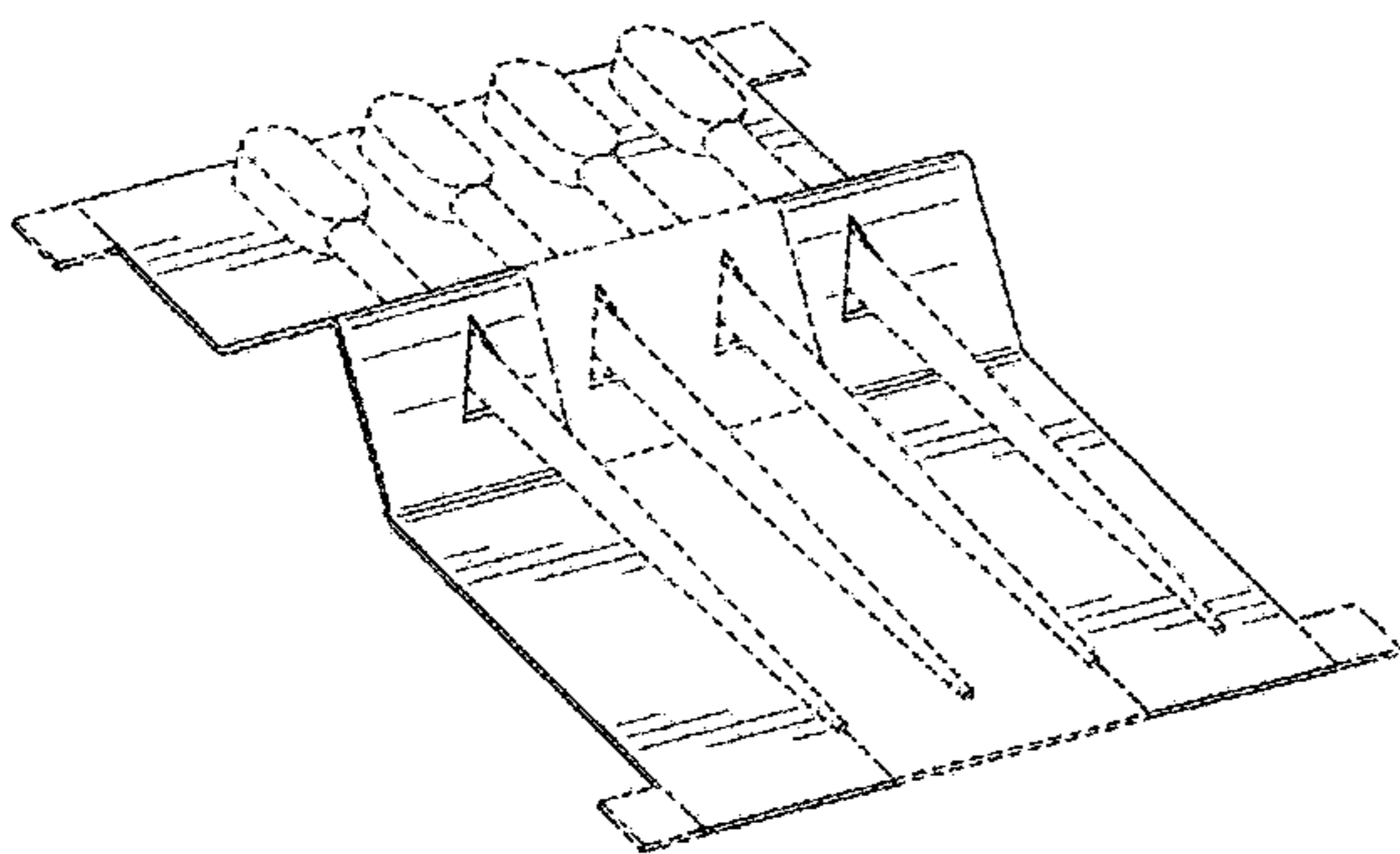

(56)

**References Cited**

U.S. PATENT DOCUMENTS

|            |   |         |                |         |
|------------|---|---------|----------------|---------|
| D261,424 S | * | 10/1981 | Anson .....    | D24/229 |
| D288,846 S | * | 3/1987  | Leonard .....  | D24/229 |
| D313,276 S | * | 12/1990 | McHugh .....   | D24/177 |
| D733,315 S | * | 6/2015  | Lui .....      | D24/227 |
| D780,936 S | * | 3/2017  | Guaragno ..... | D24/227 |

\* cited by examiner

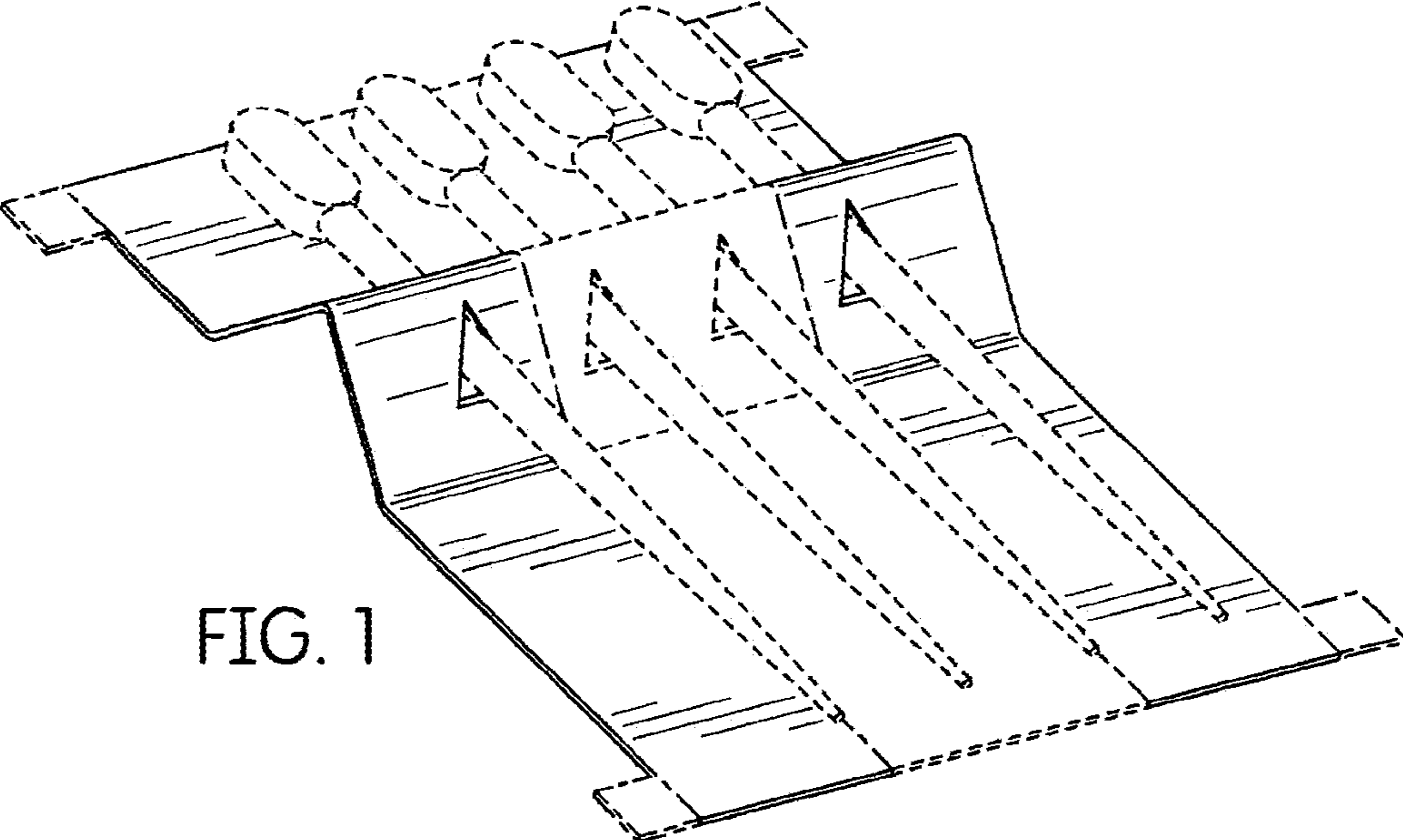

FIG. 1

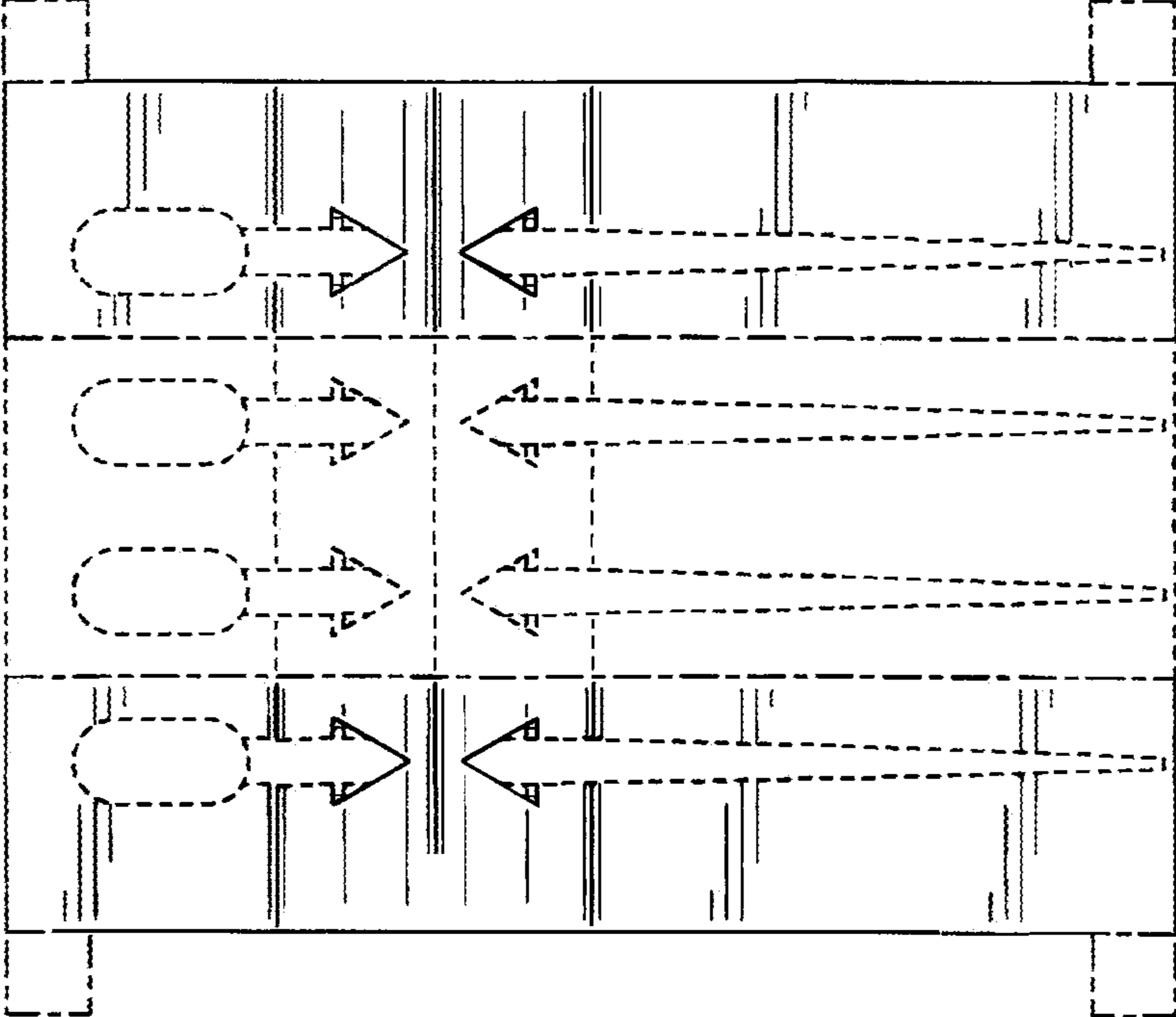

FIG. 2

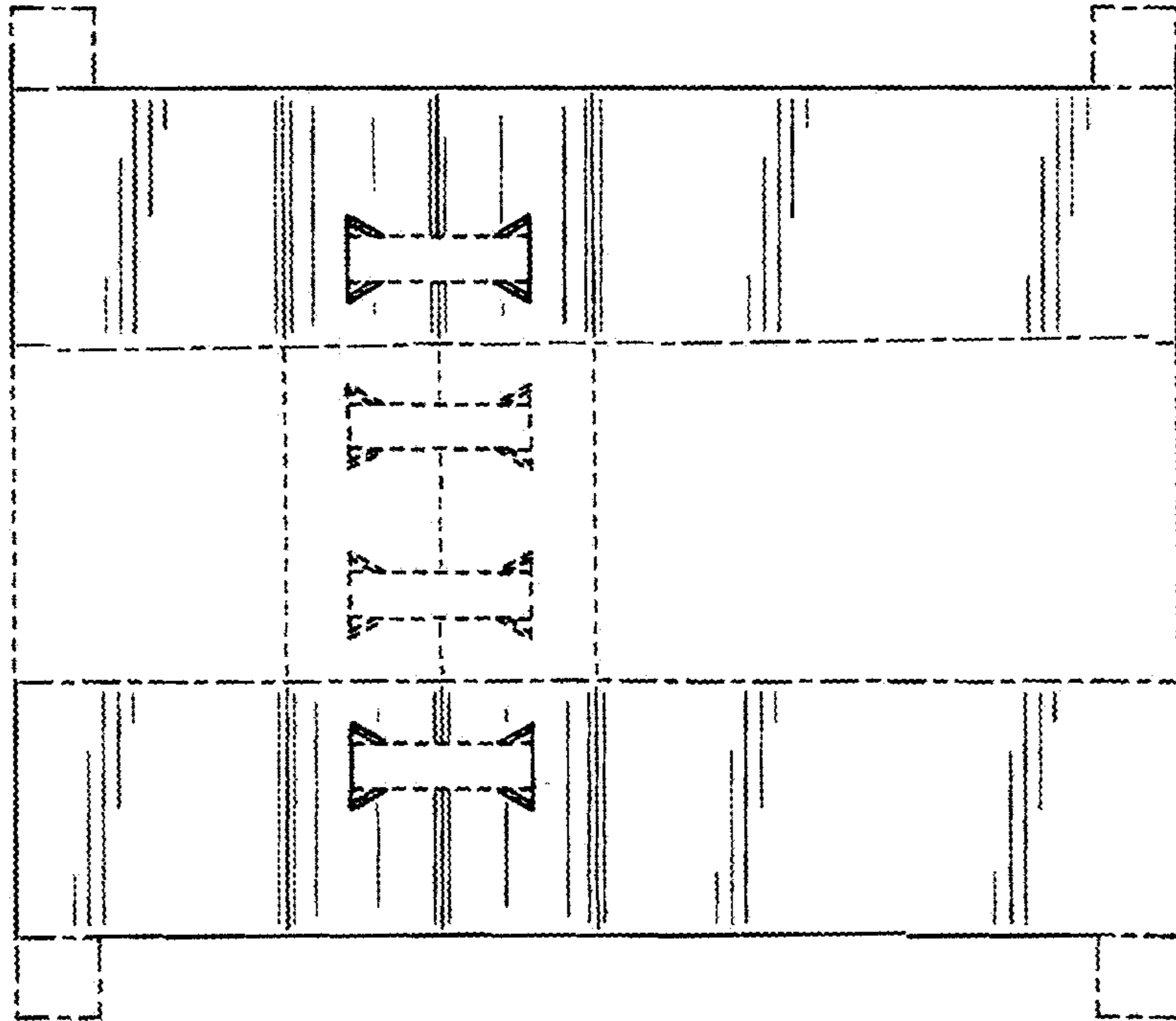

FIG. 3

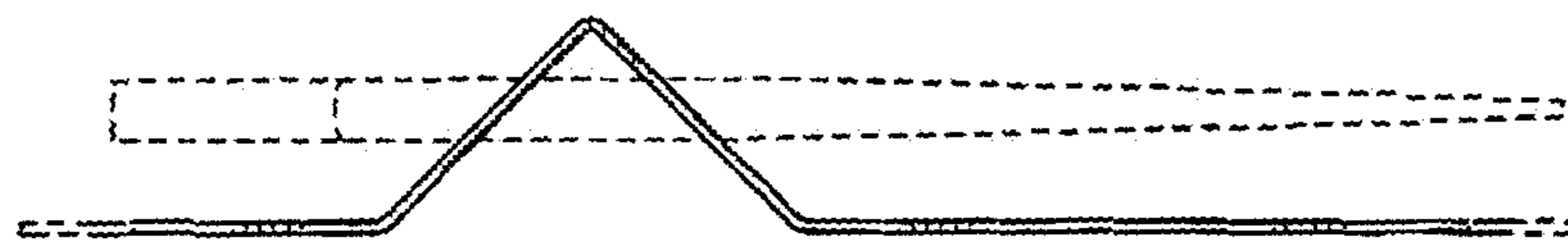

FIG. 4

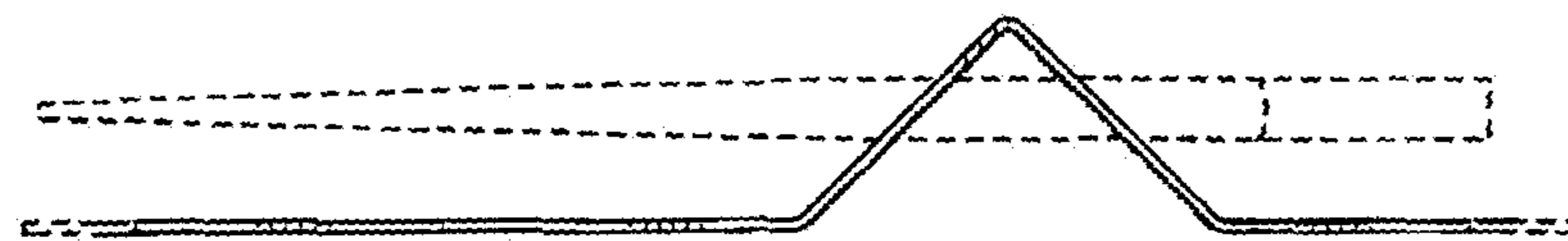

FIG. 5

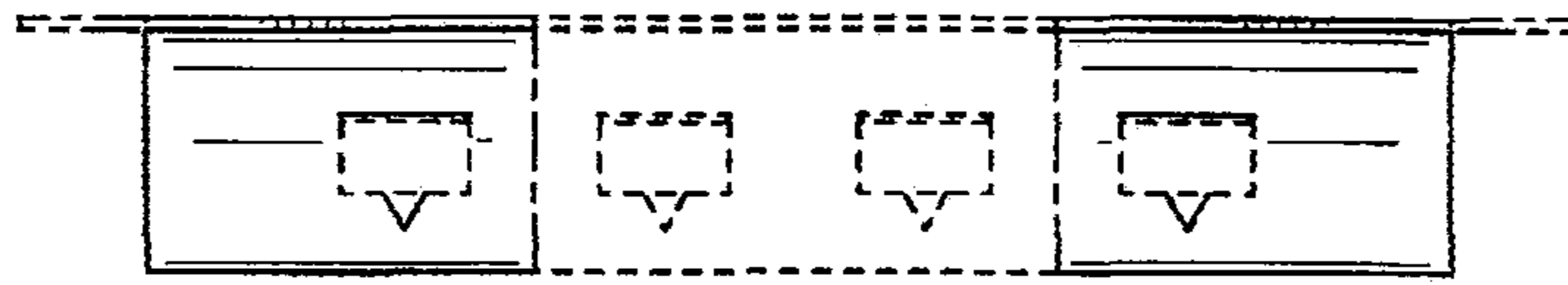
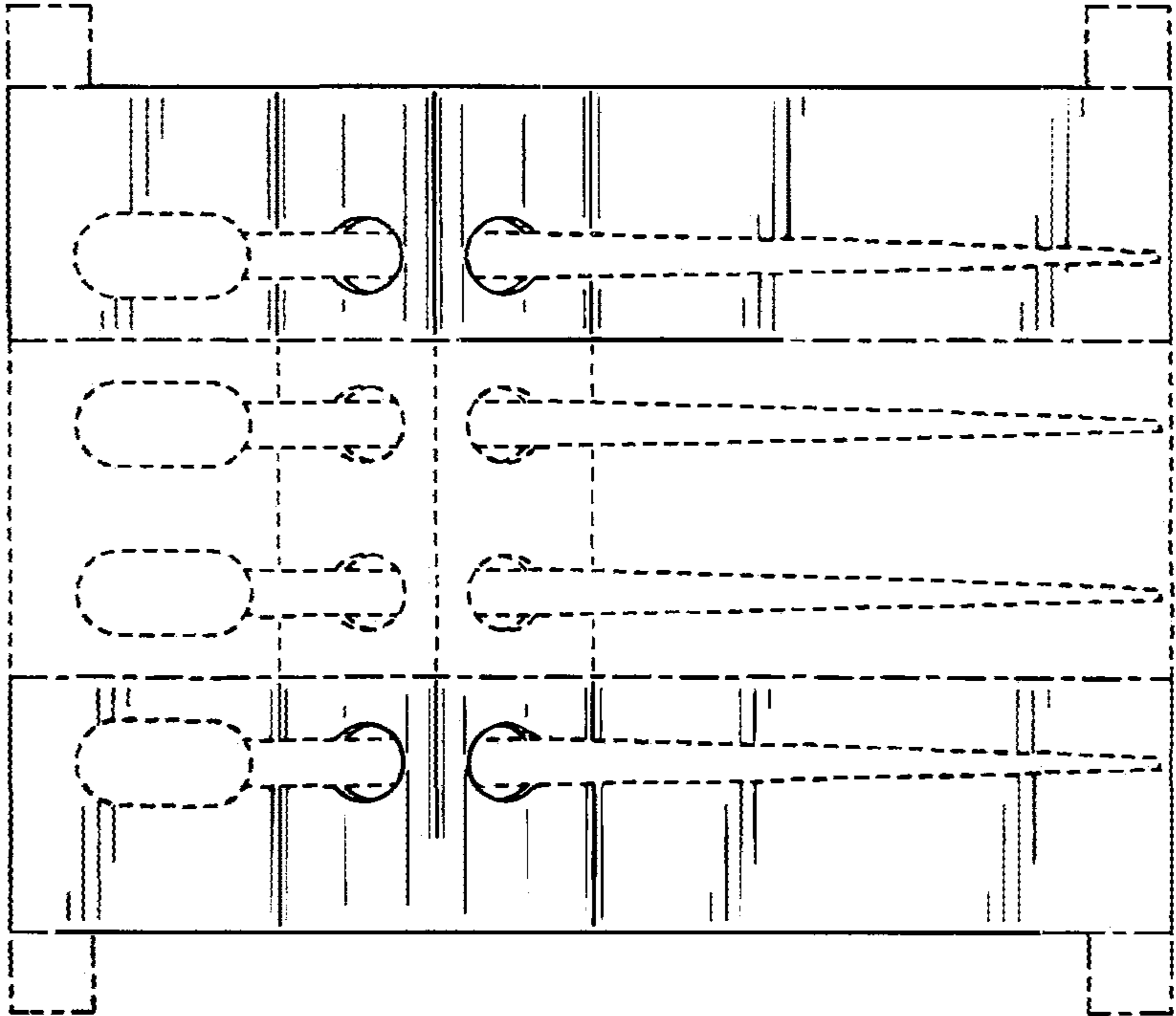
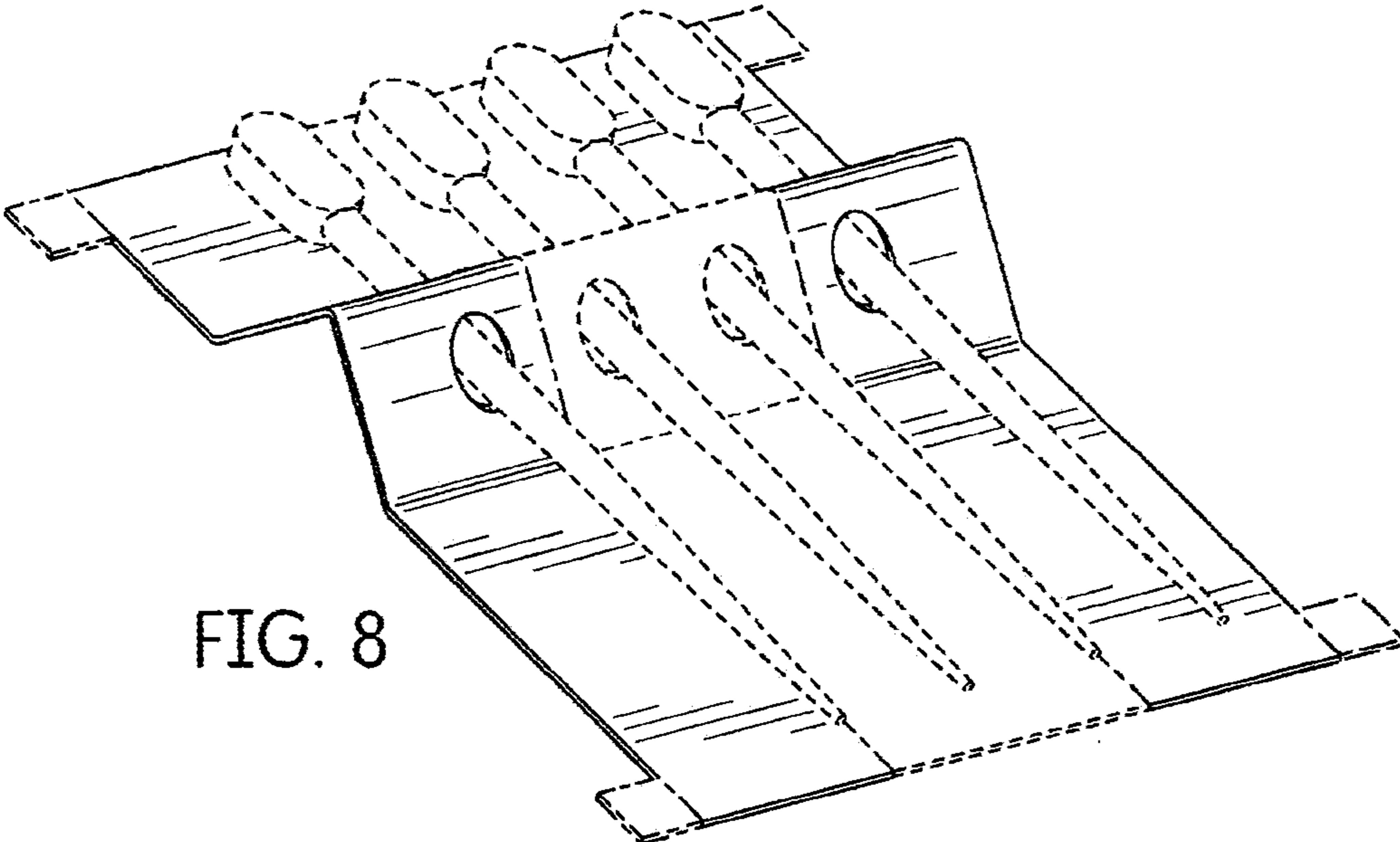

FIG. 6



FIG. 7





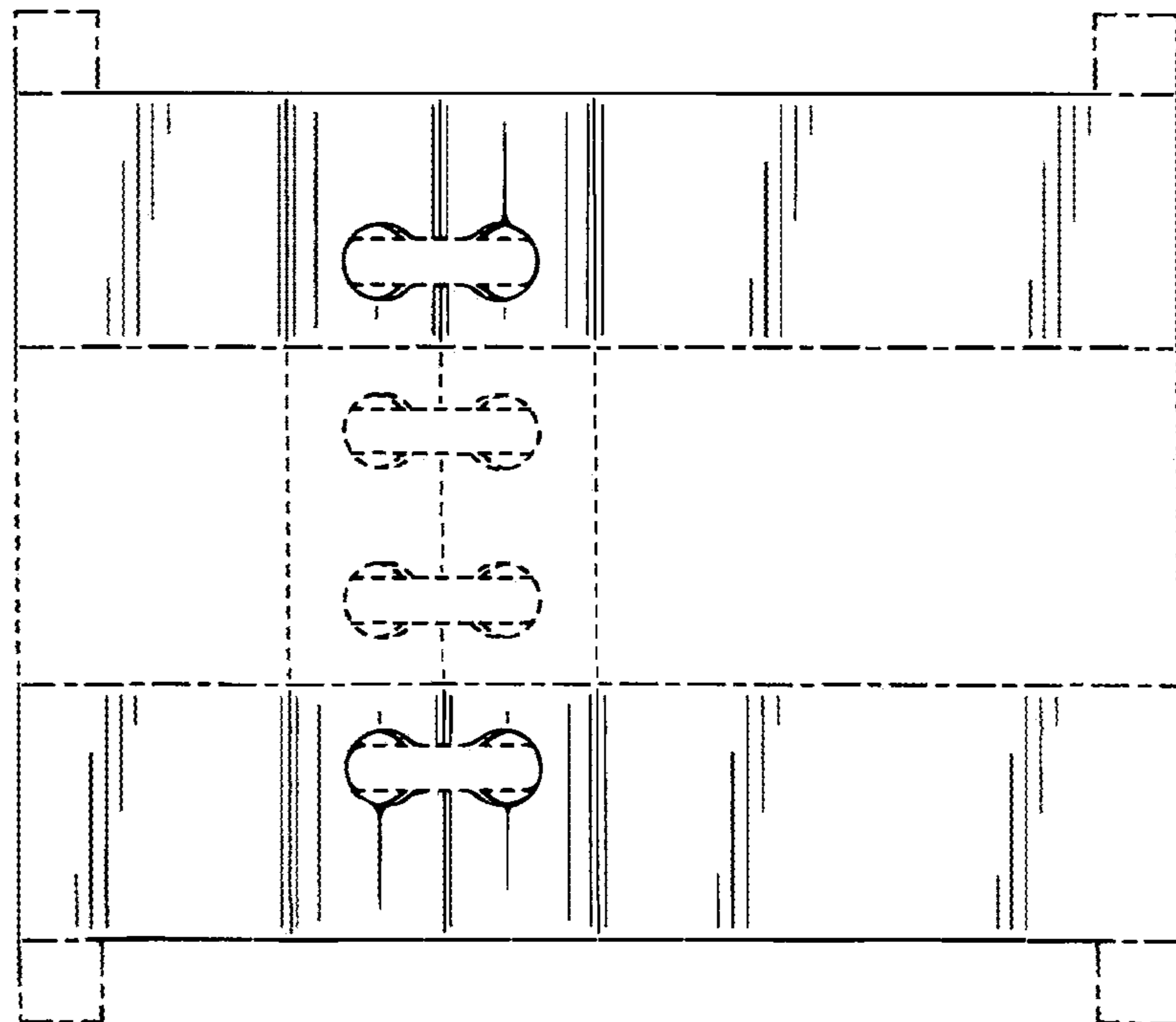

FIG. 10

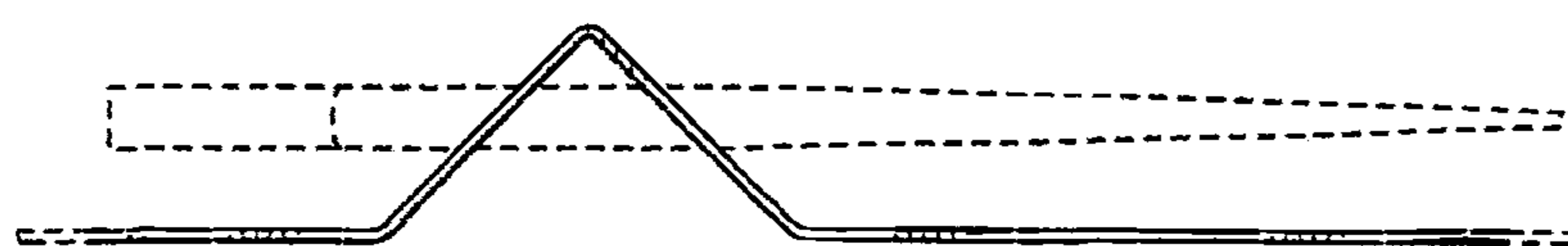

FIG. 11

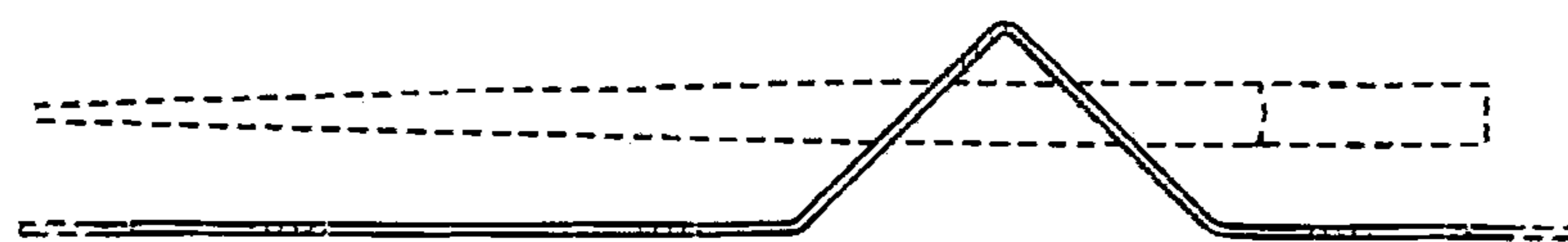

FIG. 12

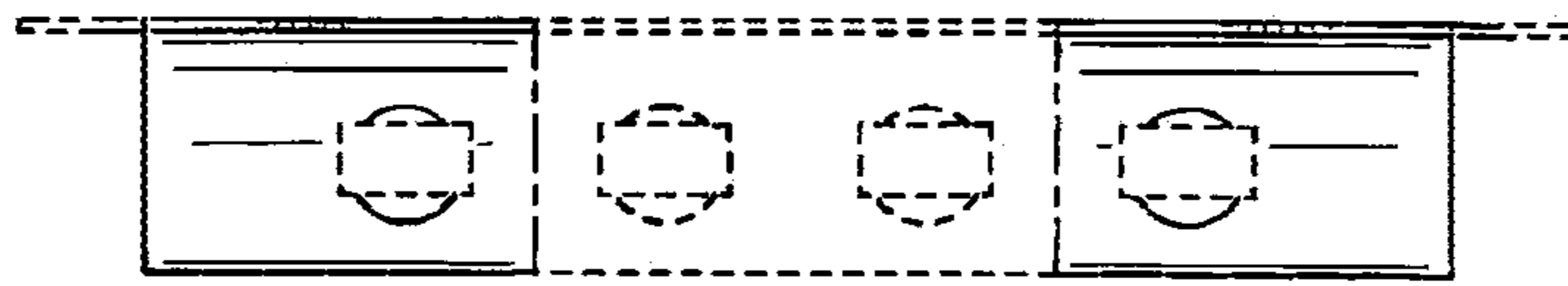

FIG. 13

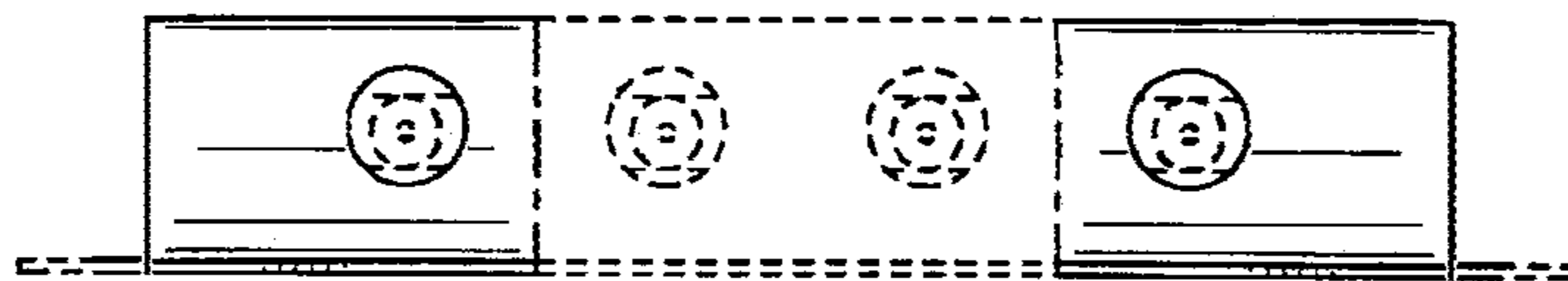

FIG. 14