



US00D810814S

(12) **United States Design Patent**
Da Forno et al.

(10) **Patent No.:** **US D810,814 S**
(45) **Date of Patent:** **** Feb. 20, 2018**

- (54) **SUNGLASSES**
- (71) Applicant: **OMEGA LTD**, Biel/Bienne (CH)
- (72) Inventors: **Alessandro Da Forno**, Pieve di Cadore (IT); **Jean-Claude Monachon**, Bevaix (CH)
- (73) Assignee: **OMEGA LTD**, Biel/Bienne (CH)
- (**) Term: **15 Years**
- (21) Appl. No.: **29/577,252**
- (22) Filed: **Sep. 12, 2016**
- (30) **Foreign Application Priority Data**
Mar. 10, 2016 (WO) DM/089 847
- (51) **LOC (11) Cl.** **16-06**
- (52) **U.S. Cl.**
USPC **D16/326**
- (58) **Field of Classification Search**
USPC D16/300, 309, 311-315, 317, 322, 327, 330
D16/325-327, 330
CPC ... G02C 7/12; G02C 5/00; G02C 1/10; G02C 5/008; G02C 5/08
See application file for complete search history.

- D708,662 S * 7/2014 Strickman Levitas D16/326
- D711,959 S * 8/2014 Javh D16/300
- D718,373 S * 11/2014 Markovitz D16/326
- D722,104 S * 2/2015 Markovitz D16/326

OTHER PUBLICATIONS

ASVP Large Frame Retro Sunglasses, posted at amazon.co.uk, posting date Apr. 22, 2010, [online], [site visited Nov. 15, 2017]. Available from Internet, URL: <https://www.amazon.co.uk/ASVP-Ladies-Womens-Vintage-Sunglasses/dp/B003IOL6GM/>.*

(Continued)

Primary Examiner — George D. Kirschbaum

Assistant Examiner — Maria J Edwards

(74) *Attorney, Agent, or Firm* — Abelman, Frayne & Schwab

CLAIM

(57) The ornamental design for sunglasses, as shown and described.

DESCRIPTION

FIG. 1 is a front right perspective view of sunglasses showing our new design;
 FIG. 2 is a rear left perspective view thereof;
 FIG. 3 is a front view thereof;
 FIG. 4 is a rear view thereof;
 FIG. 5 is a left side view thereof;
 FIG. 6 is a top view thereof;
 FIG. 7 is a bottom view thereof;
 FIG. 8 is a front right perspective view folded up thereof;
 FIG. 9 is a rear left perspective view thereof;
 FIG. 10 is a front view thereof;
 FIG. 11 is a rear view thereof;
 FIG. 12 is a left side view thereof;
 FIG. 13 is a right side view thereof;
 FIG. 14 is a top view thereof; and,
 FIG. 15 is a bottom view thereof.

1 Claim, 10 Drawing Sheets

- (56) **References Cited**
U.S. PATENT DOCUMENTS
D203,482 S * 1/1966 McCulloch D16/317
D216,485 S * 1/1970 Bloch D16/326
D217,697 S * 5/1970 McCracken D16/317
D243,010 S * 1/1977 Shindler D16/326
D275,399 S * 9/1984 Zancaner D16/324
D280,639 S * 9/1985 Zancaner D16/323
D633,938 S * 3/2011 Della Valle D16/321
D682,921 S * 5/2013 Sallard D16/323
D694,809 S * 12/2013 Della Valle D16/326

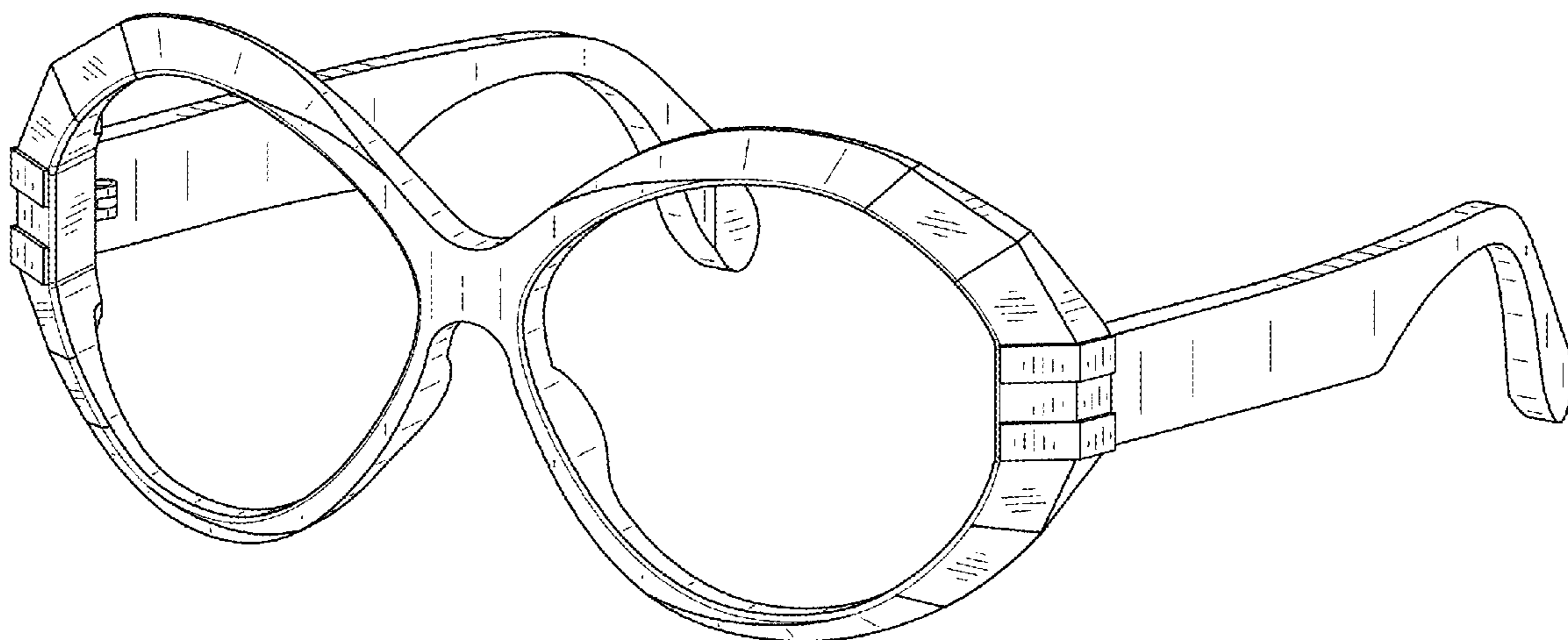

(56)

References Cited

OTHER PUBLICATIONS

Burberry BE4160, posted at sunglasshut.com, posting date not given, [online], [site visited Nov. 15, 2017]. Available from Internet, URL: <http://www.sunglasshut.com/us/8053672203776>.*

Omega S680, posted at omegawatches.com, posting date Sep. 12, 2016 as found by tineye.com, [online], [site visited Nov. 15, 2017]. Available from Internet, URL: <https://tineye.com/search/6ee71d38f8b0a82f41ae5e57e46c81b74b49282a/>.*

Ray-Ban Women's Jackie Ohh II Butterfly Sunglasses, posted at ebay.com, posting date not given, [online], [site visited Nov. 15, 2017]. Available from Internet, URL: <https://www.ebay.com/itm/Ray-Ban-Womens-Jackie-Ohh-II-Butterfly-Sunglasses-RB4098-601-8G-60/152547088230>.*

* cited by examiner

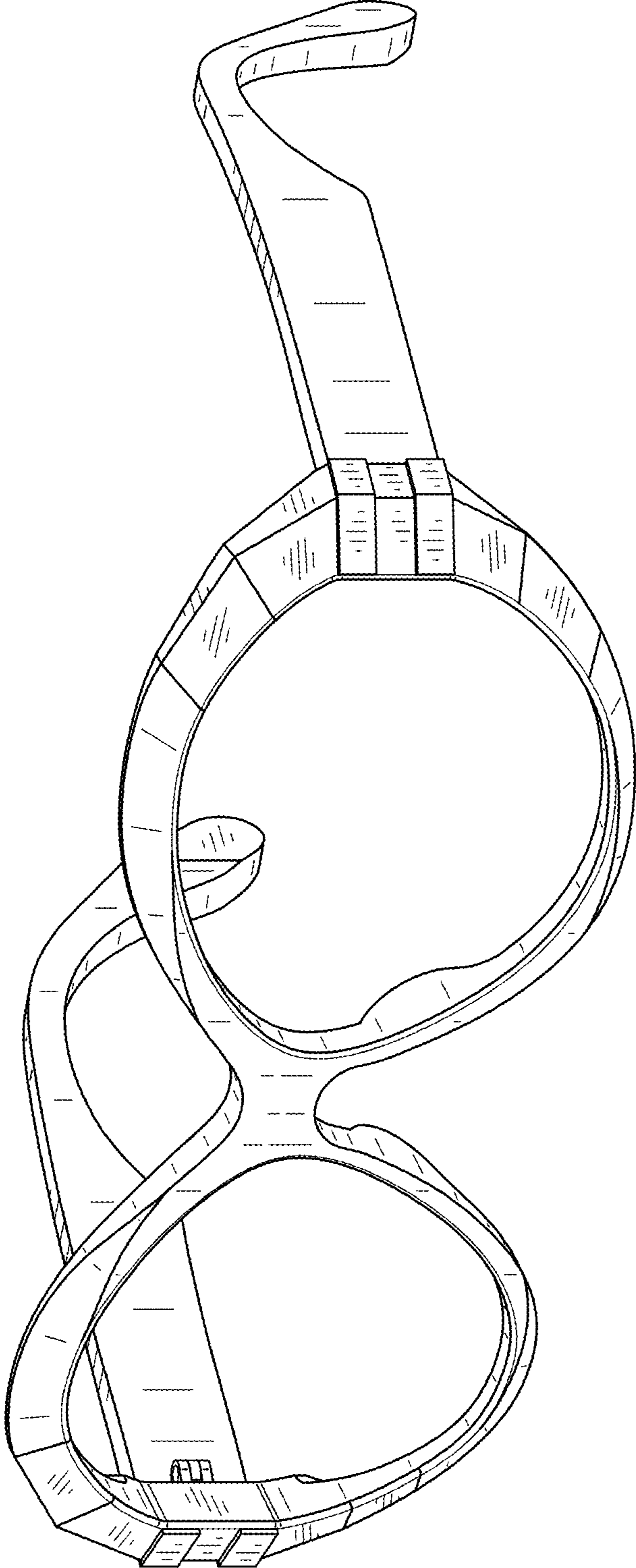

FIG. 1

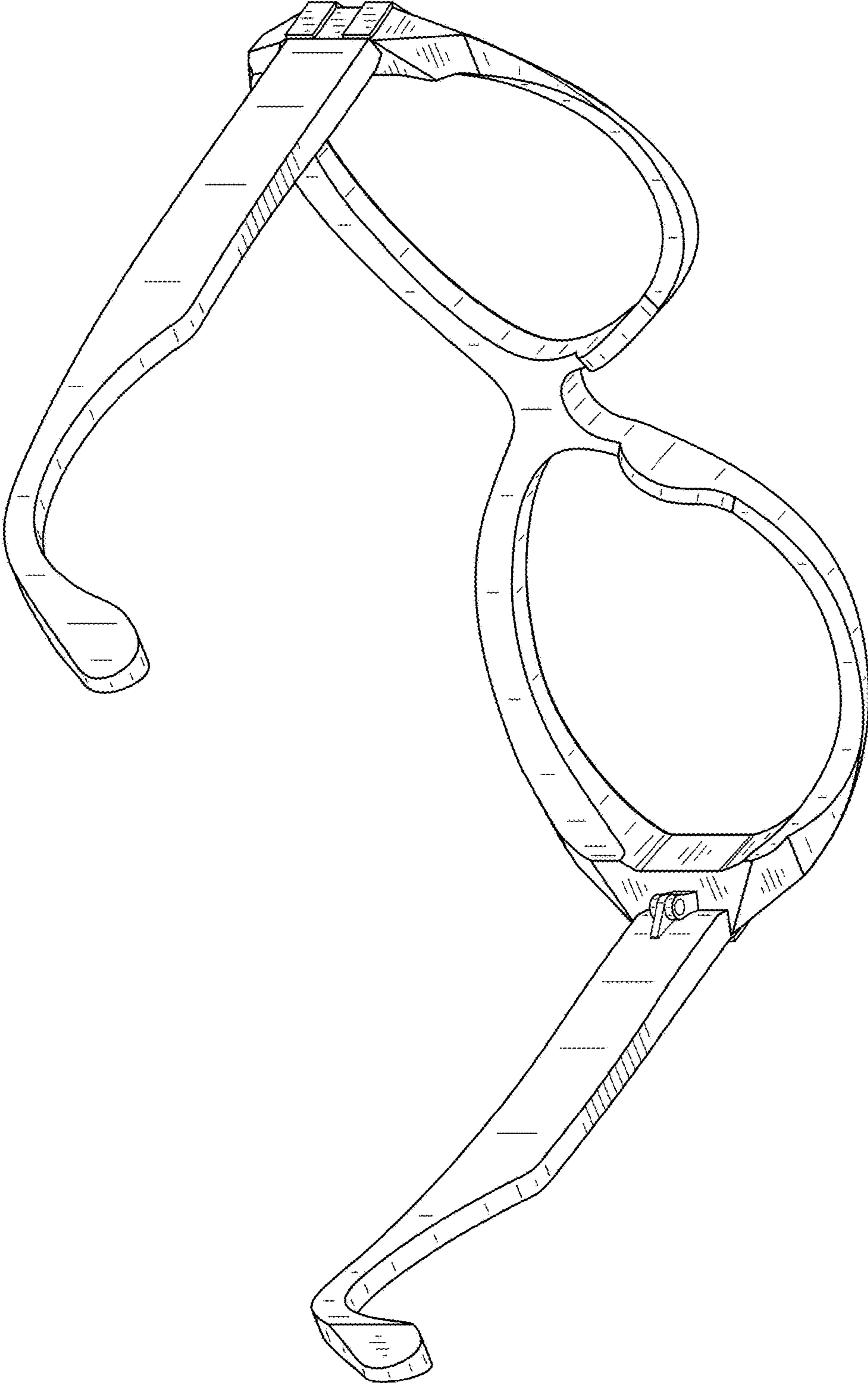

FIG. 2

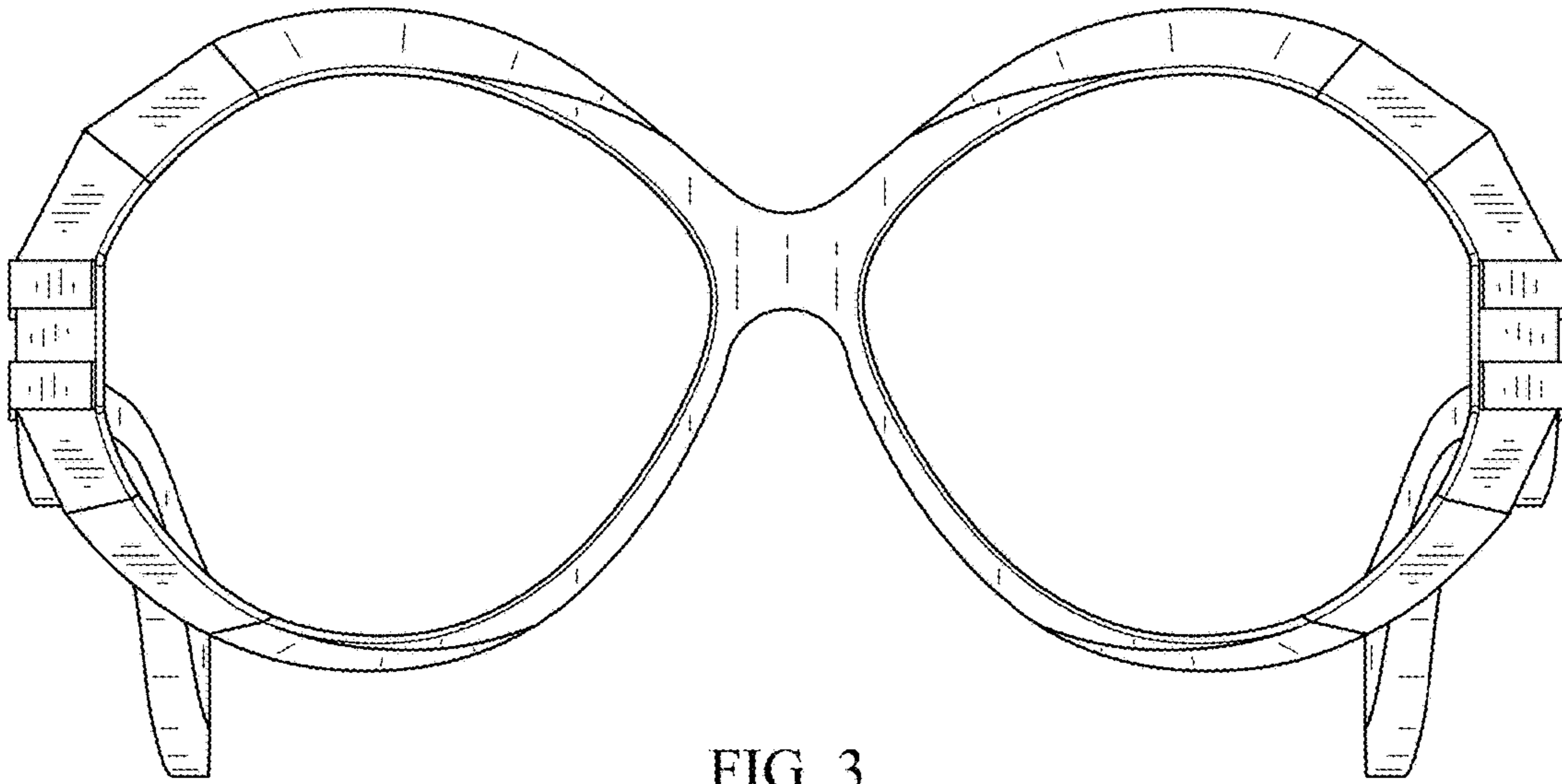

FIG. 3

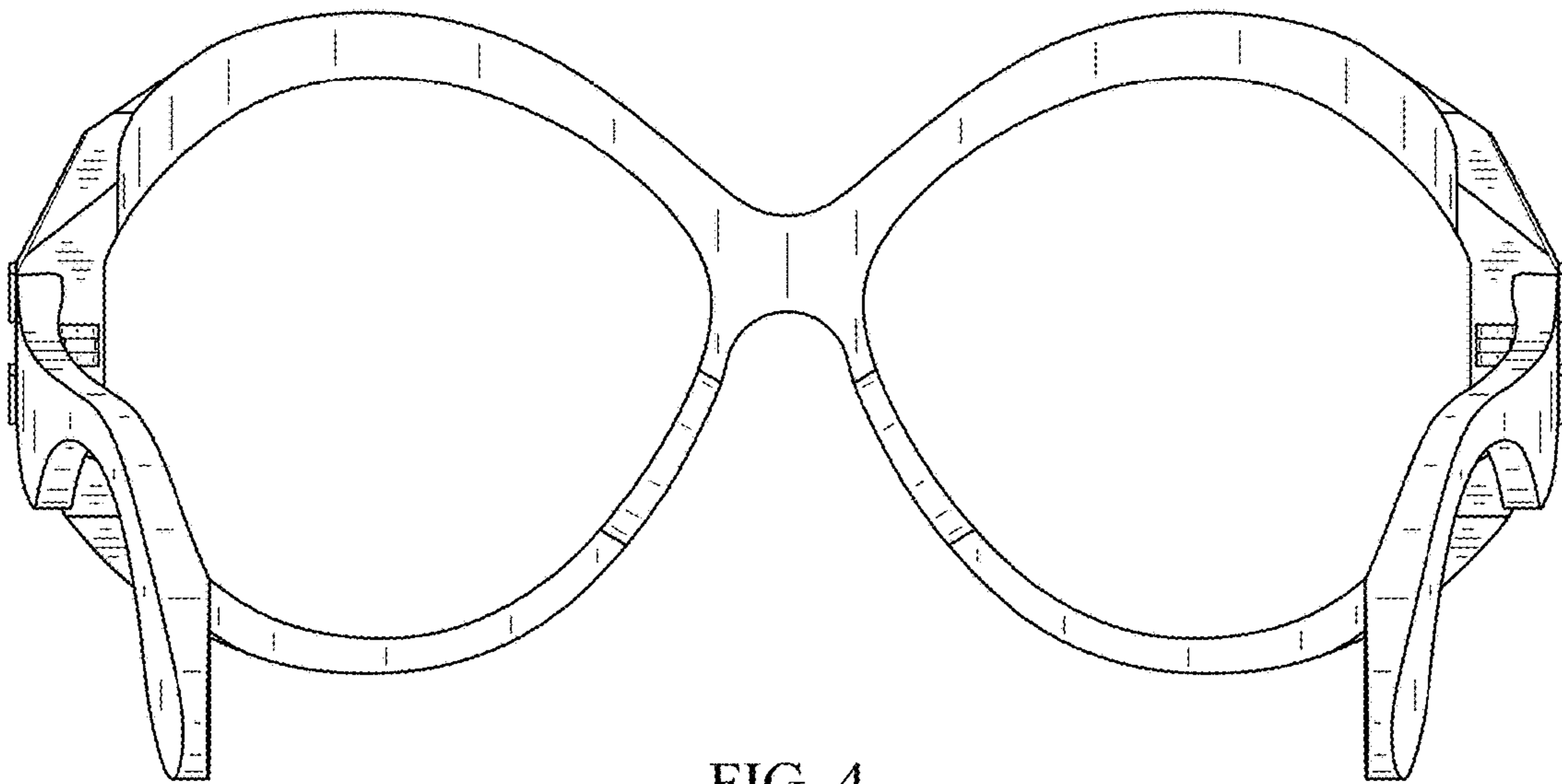

FIG. 4

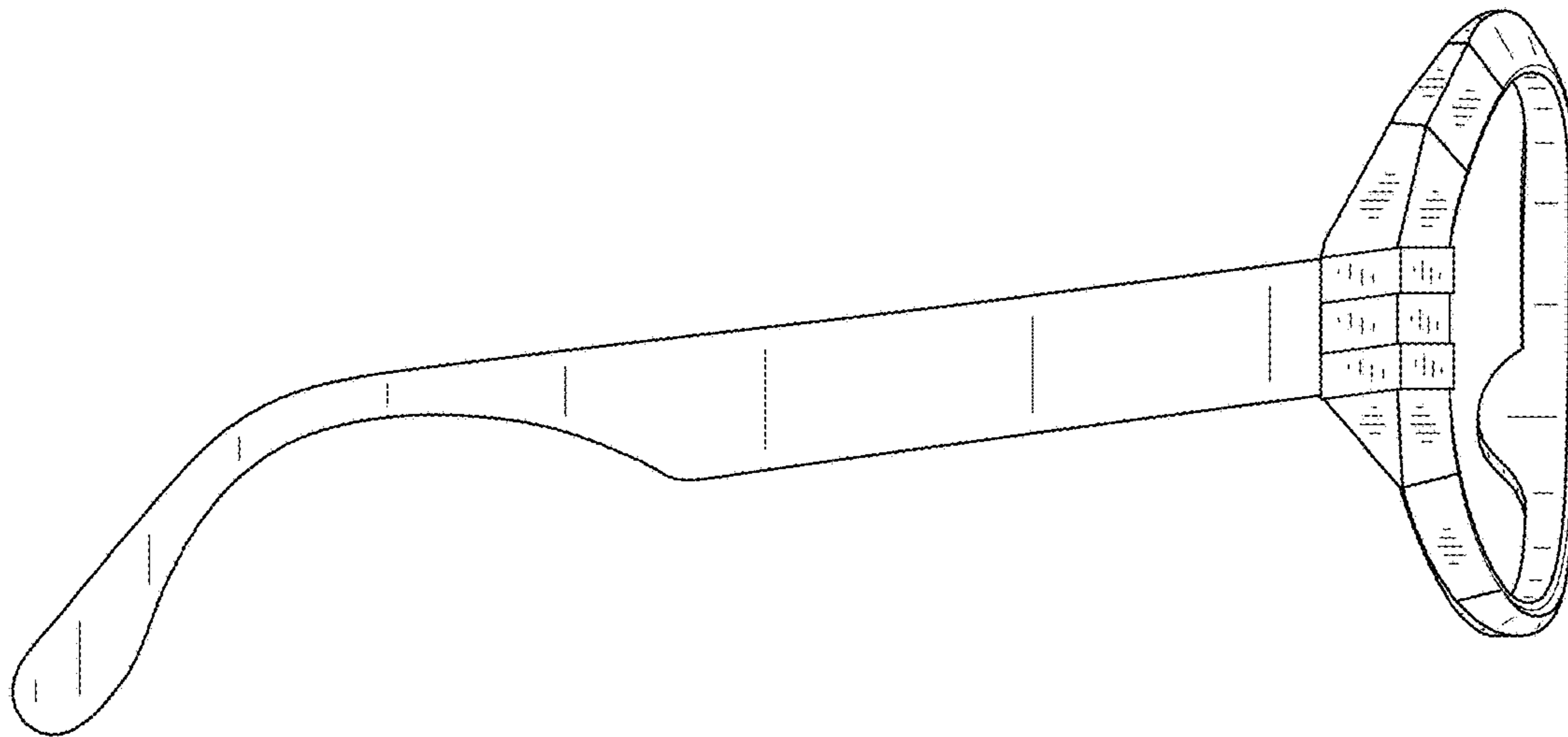

FIG. 5

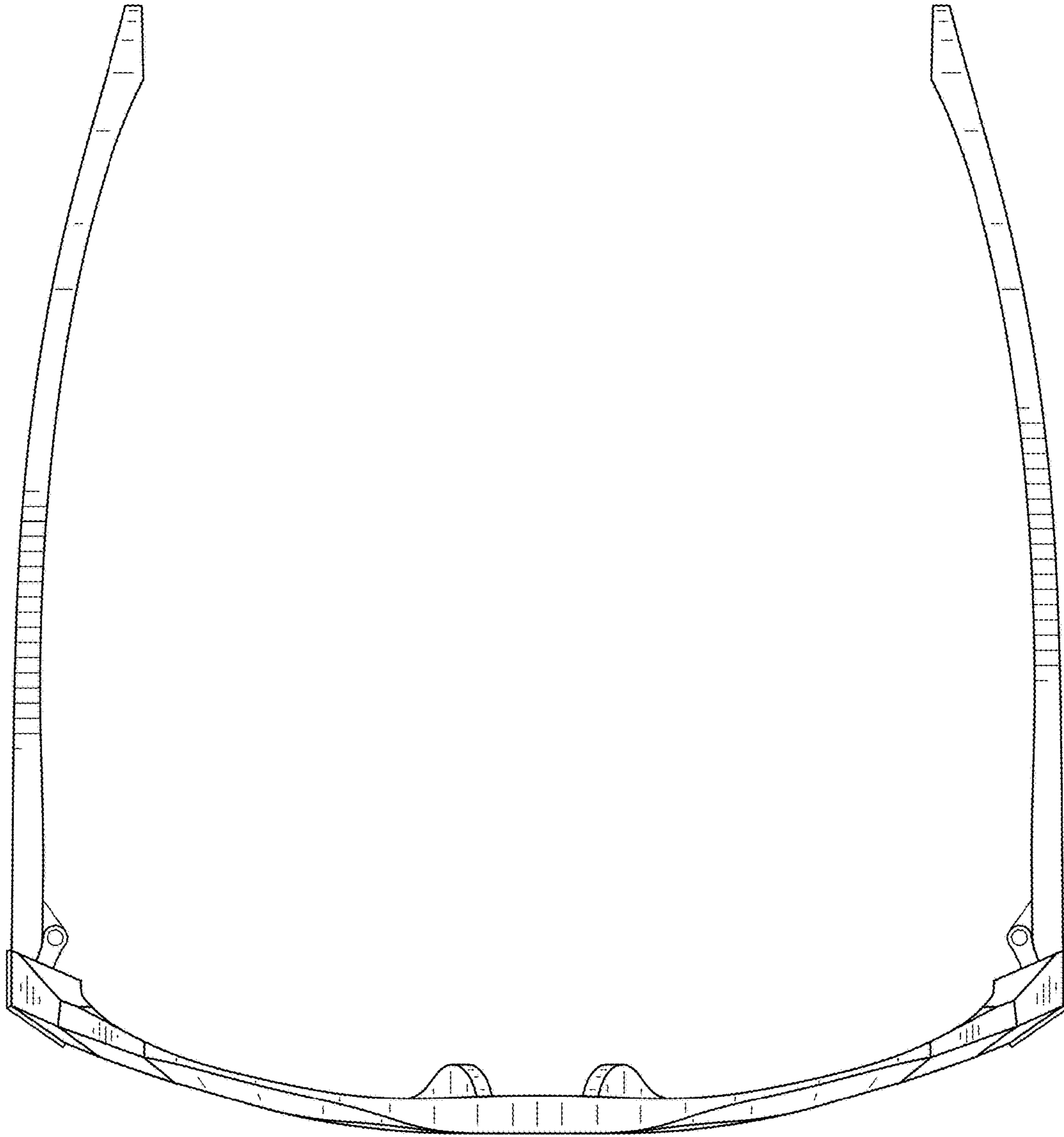

FIG. 6

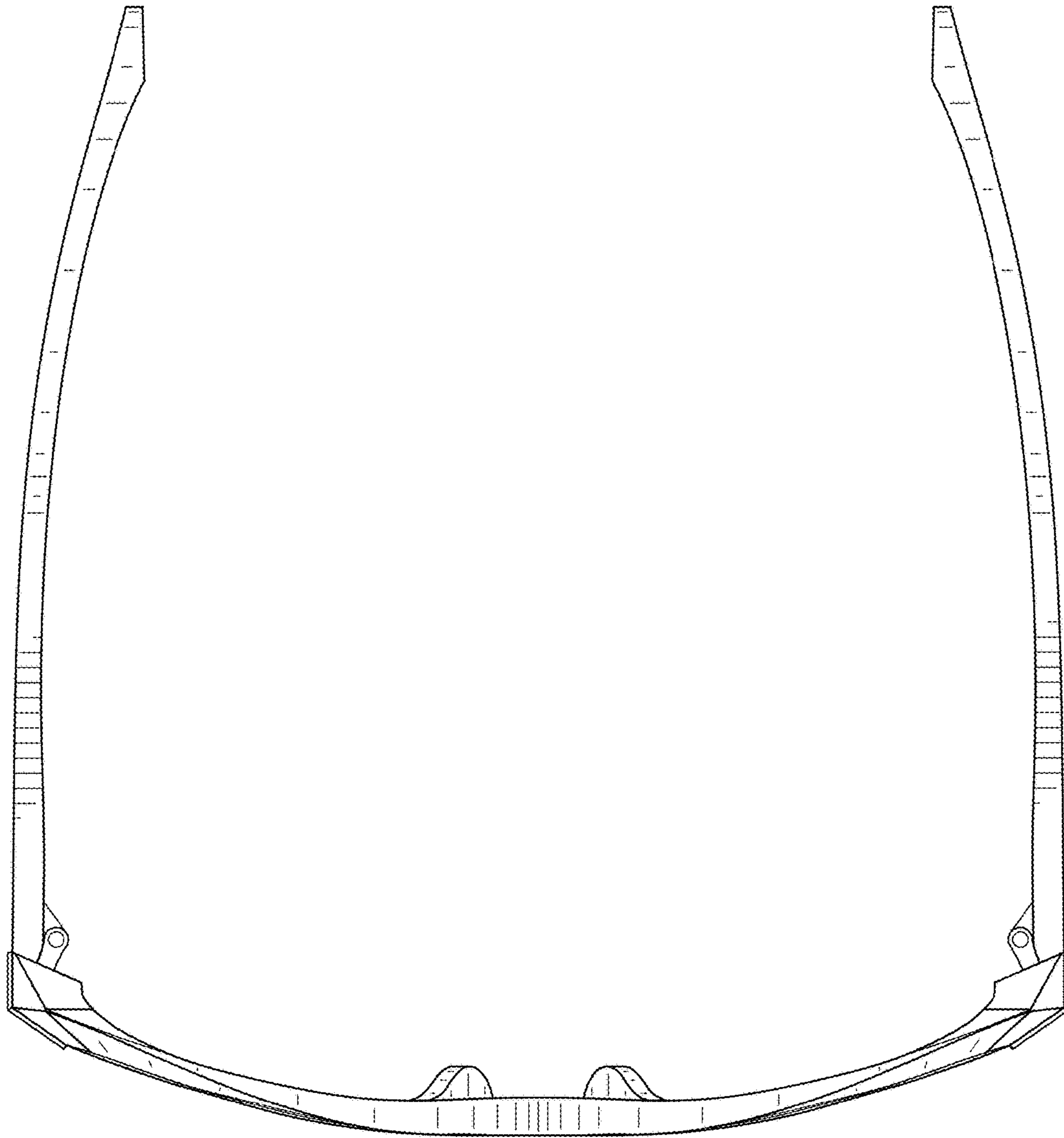

FIG. 7

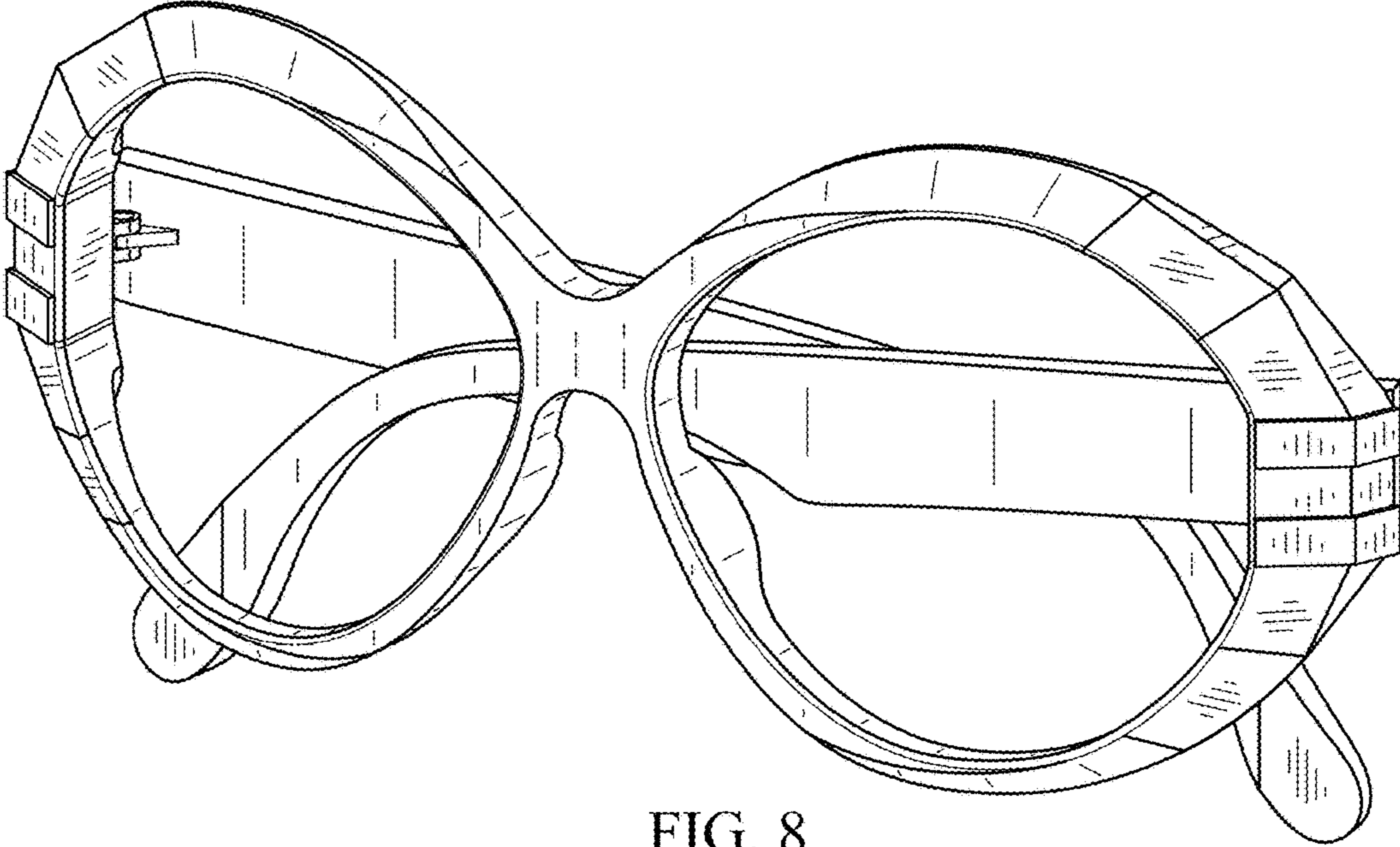

FIG. 8

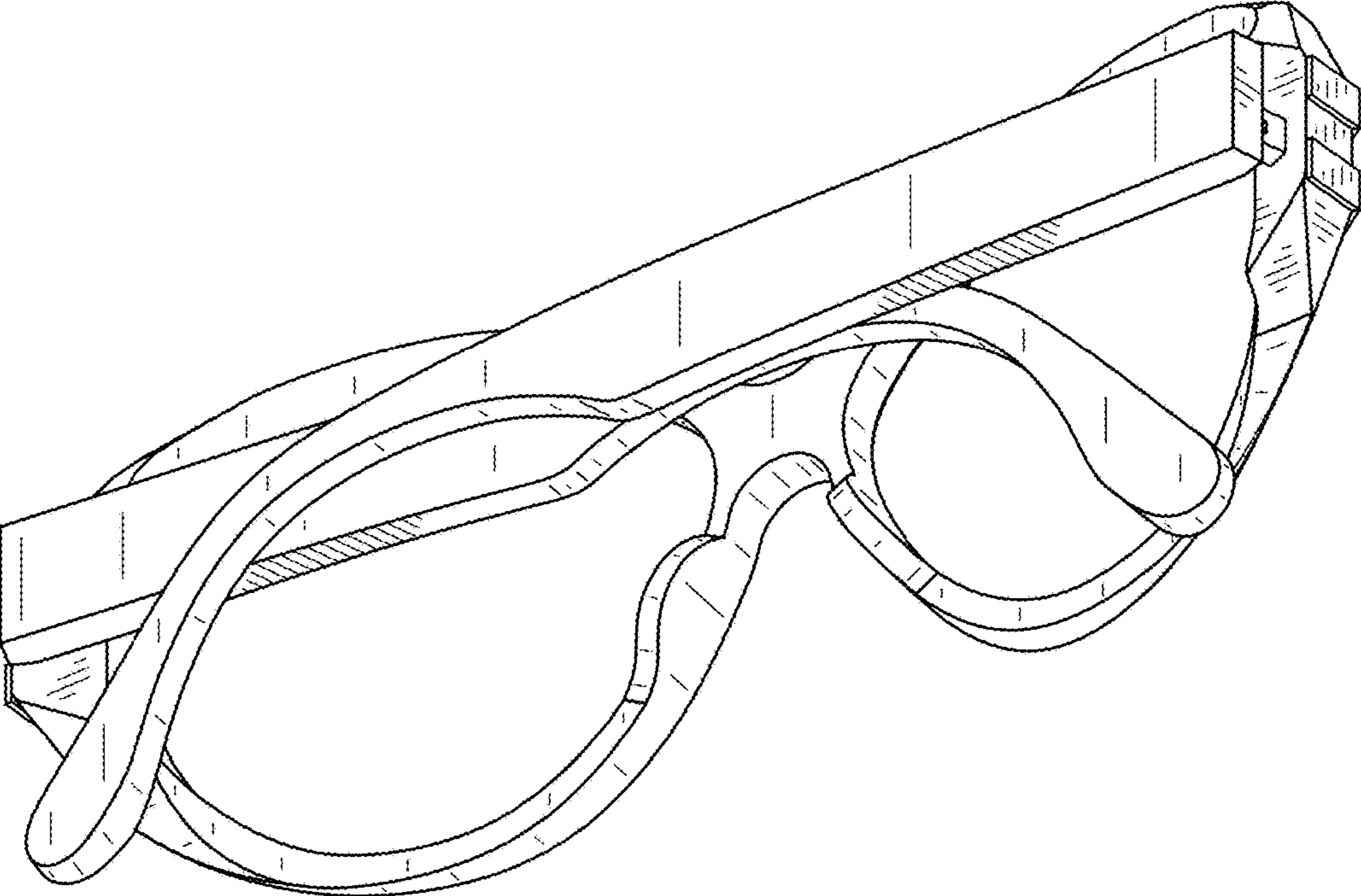

FIG. 9

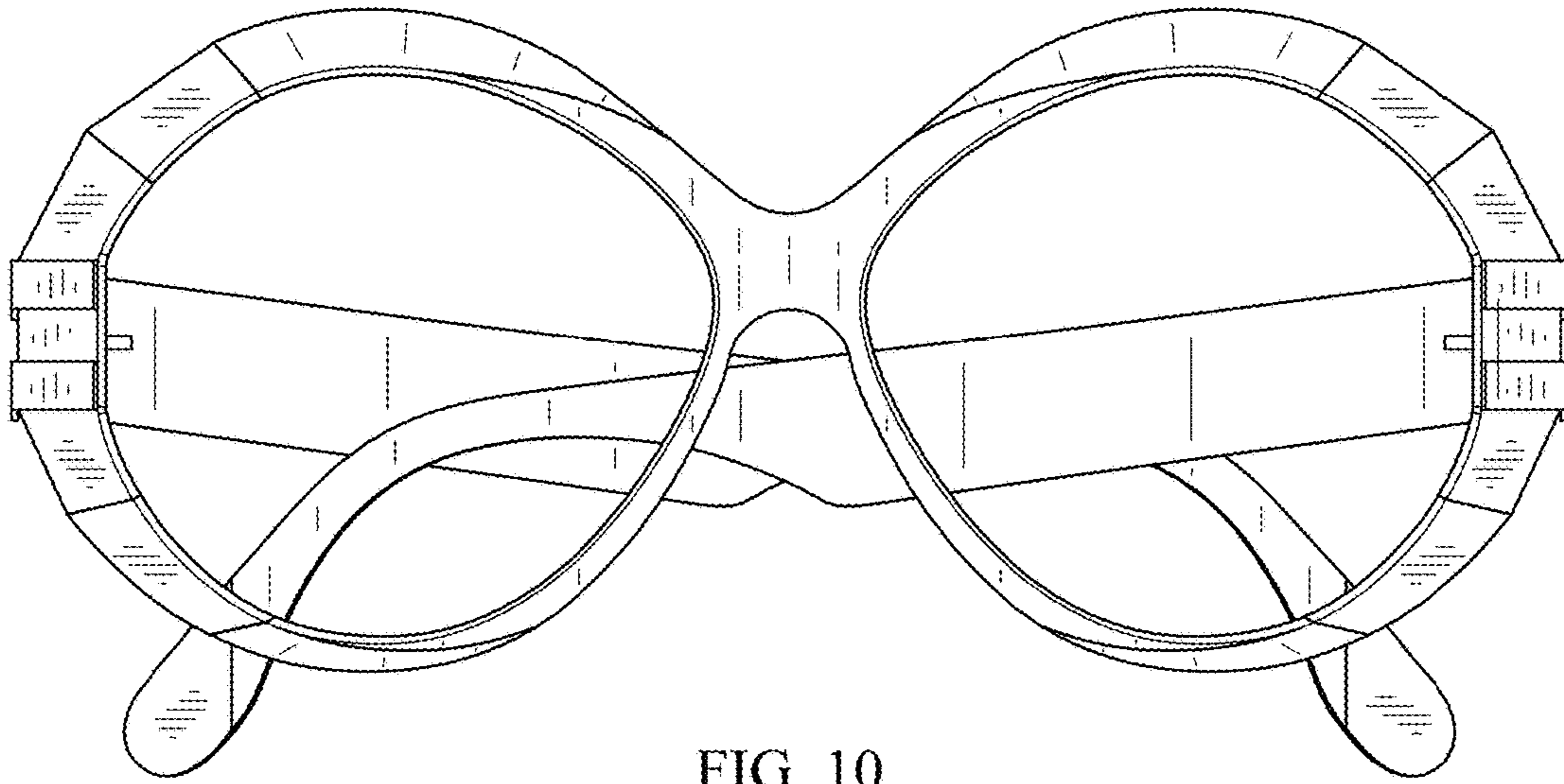

FIG. 10

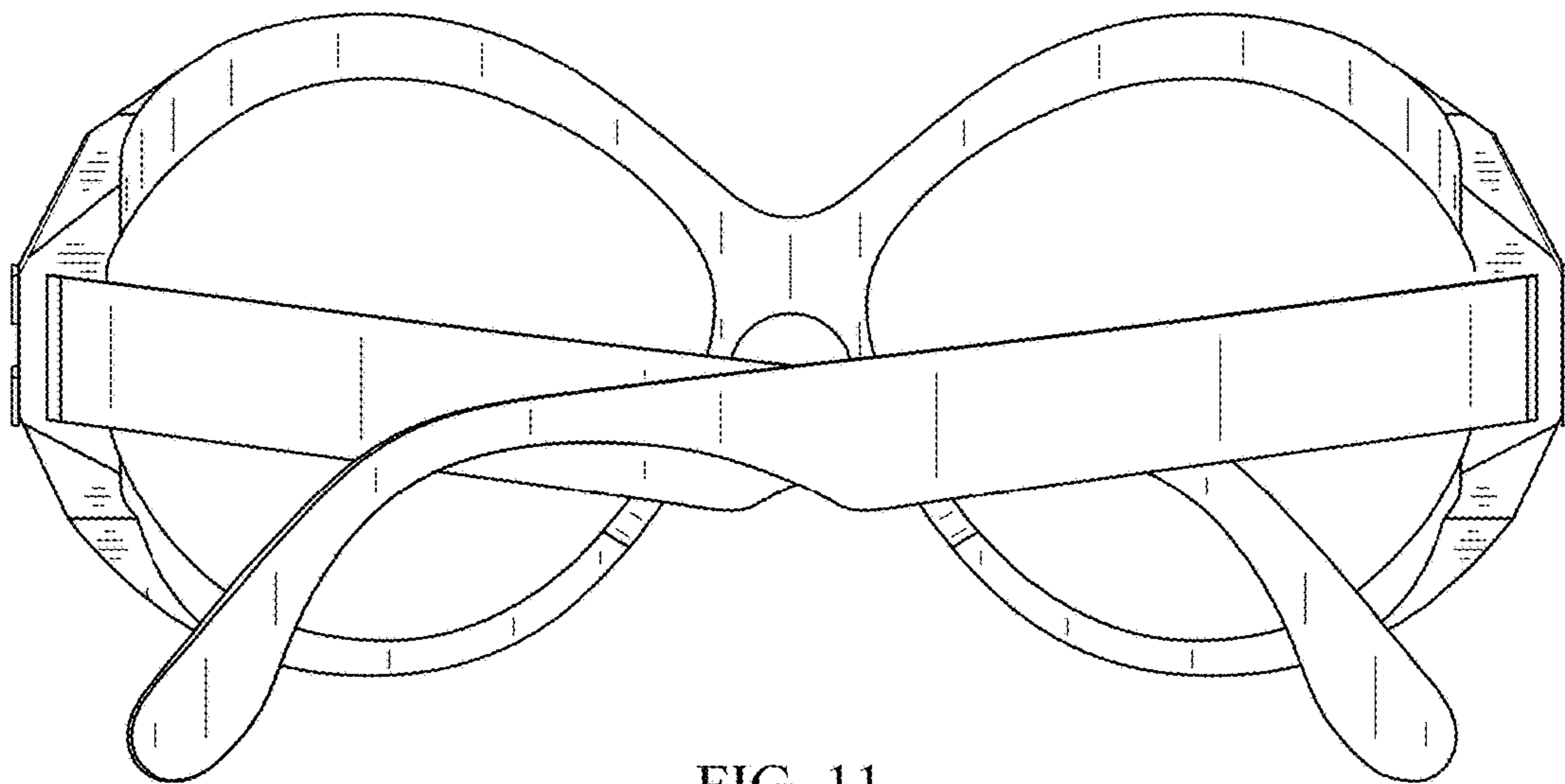

FIG. 11

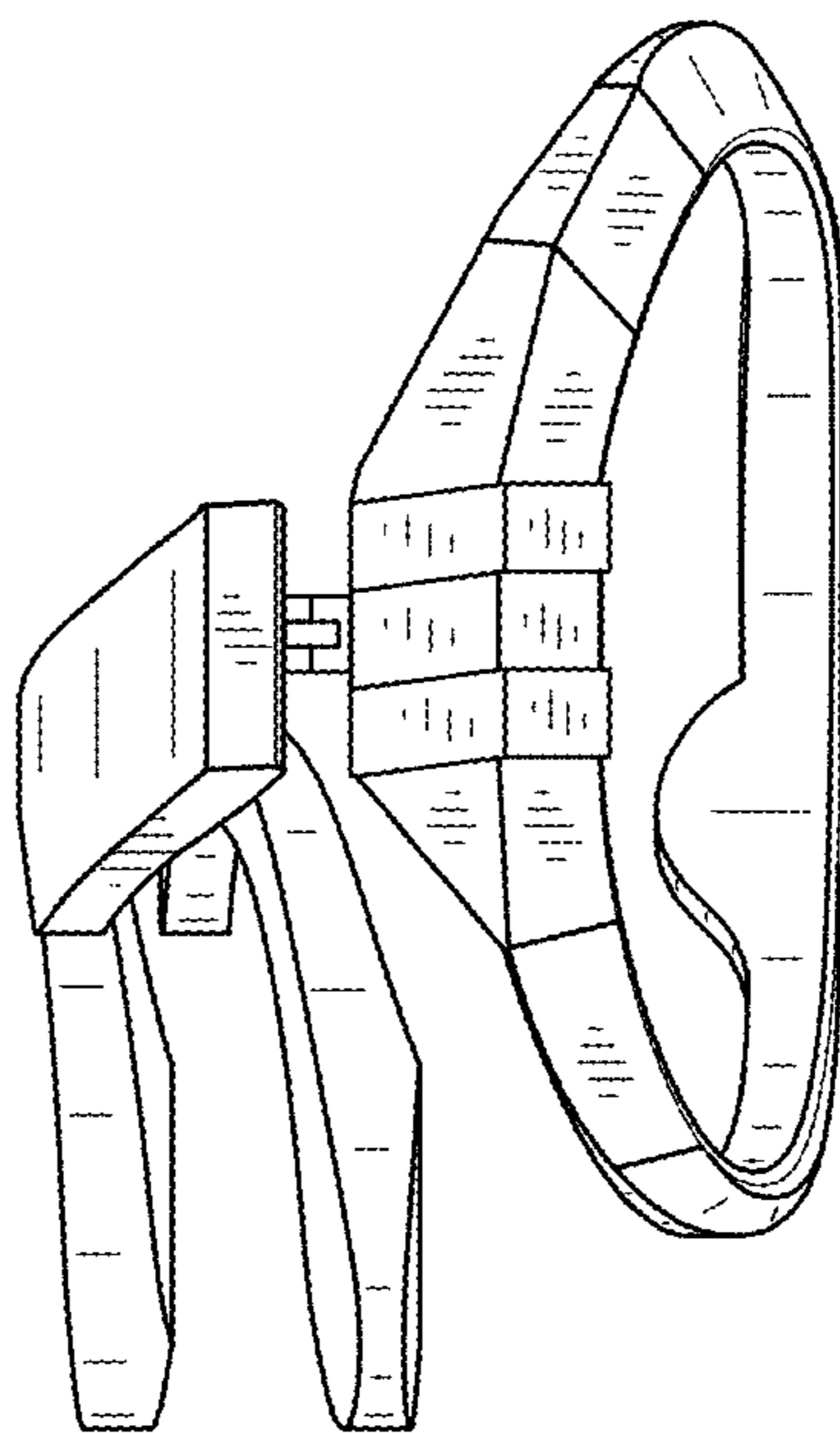

FIG. 12

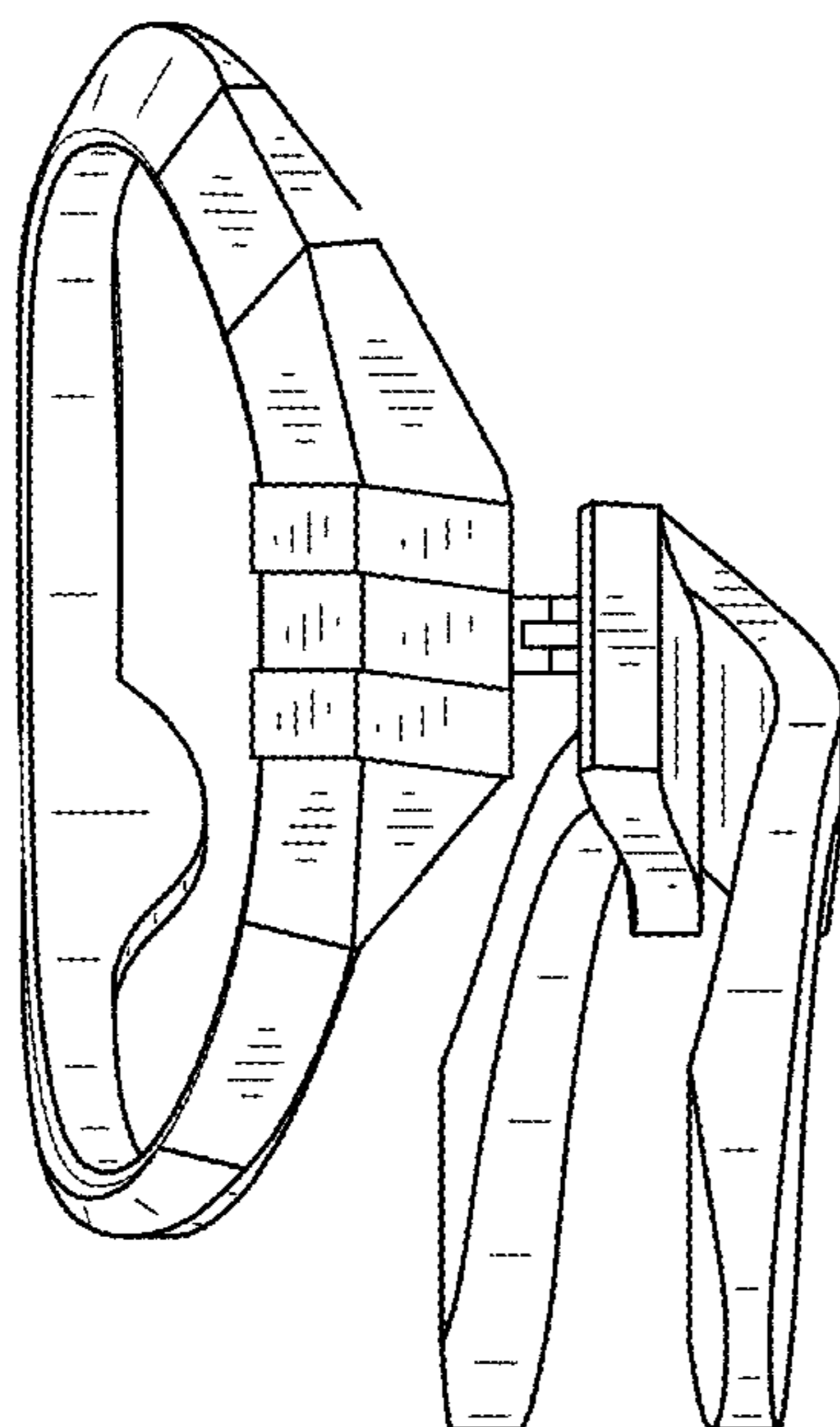

FIG. 13

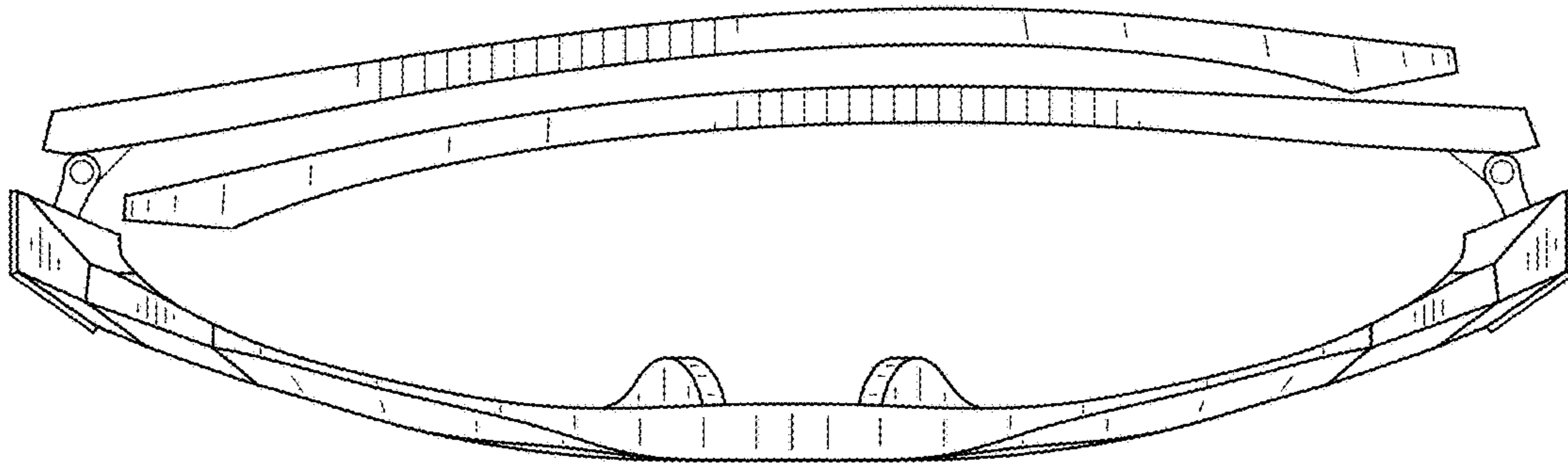

FIG. 14

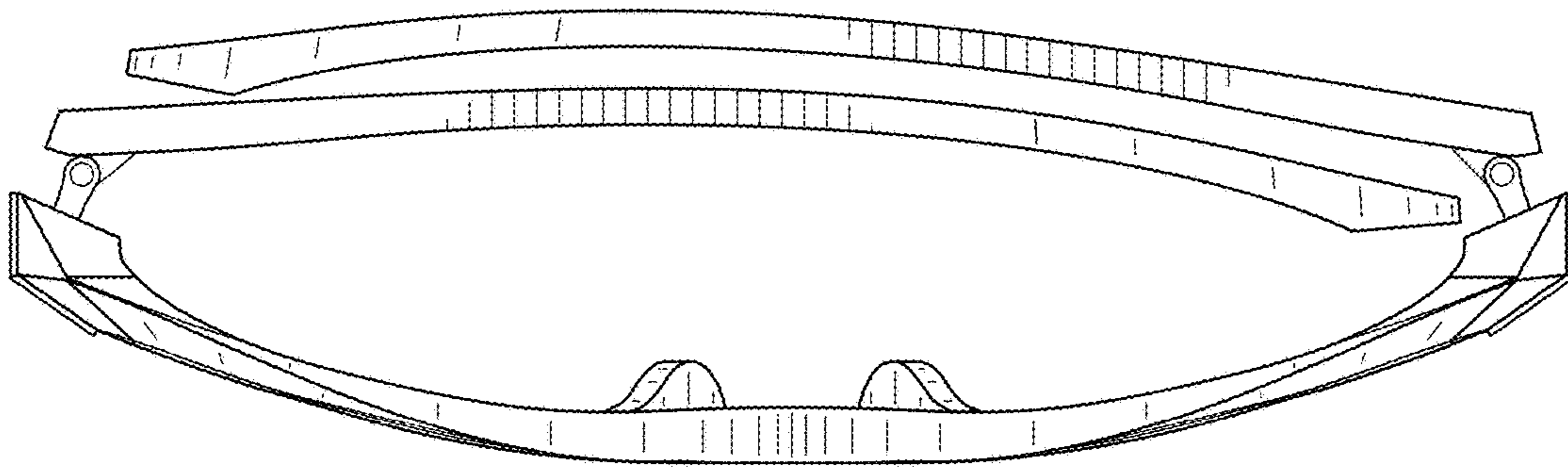

FIG. 15