



US00D810739S

(12) **United States Design Patent** (10) **Patent No.:** **US D810,739 S**  
**Mitsugi et al.** (45) **Date of Patent:** **\*\* Feb. 20, 2018**

(54) **WEARABLE DEVICE**

- (71) Applicant: **SONY CORPORATION**, Tokyo (JP)
- (72) Inventors: **Masakazu Mitsugi**, Kanagawa (JP); **Yuki Sugiue**, Tokyo (JP); **Yoichi Ito**, Tokyo (JP); **Masaaki Yamamoto**, Chiba (JP); **Michiko Takematsu**, Kanagawa (JP); **Hiroshi Saeki**, Tokyo (JP)
- (73) Assignee: **SONY CORPORATION**, Tokyo (JP)
- (\*\*) Term: **15 Years**
- (21) Appl. No.: **29/607,111**
- (22) Filed: **Jun. 9, 2017**

**Related U.S. Application Data**

- (62) Division of application No. 29/516,138, filed on Jan. 29, 2015, now Pat. No. Des. 794,012.

(30) **Foreign Application Priority Data**

- Sep. 3, 2014 (JP) ..... D2014-019436  
 Sep. 3, 2014 (JP) ..... D2014-019437  
 Sep. 4, 2014 (CN) ..... 2014 3 0326439

- (51) **LOC (11) Cl.** ..... **14-02**

- (52) **U.S. Cl.**  
 USPC ..... **D14/344**; D10/38

(58) **Field of Classification Search**

- USPC ..... D2/623, 626, 639, 878; D8/88, 356;  
 D10/30-39, 70, 98; D11/3, 87, 93-94,  
 D11/200, 201, 210, 216, 218, 221,  
 D11/230-231; D14/344, 138 R, 144,  
 D14/358; D24/167, 169, 186-187  
 CPC ..... G06F 1/163; G06F 1/1628; G06F 1/1626;  
 G06F 1/1635; G06F 1/08; G06F 1/10;  
 G06F 1/04; G06F 1/14; G06F 1/3203;  
 A41D 1/002; H04M 1/02; H04M 1/03;  
 H04M 1/04; H04M 1/05; H04M 1/667;  
 H04M

(Continued)

(56) **References Cited**

U.S. PATENT DOCUMENTS

- 3,789,601 A \* 2/1974 Bergey ..... G04G 5/04  
 368/239  
 D235,788 S 7/1975 Eberhardt  
 5,297,121 A 3/1994 Sepehri  
 (Continued)

FOREIGN PATENT DOCUMENTS

- JP 2007-078670 A 3/2007

OTHER PUBLICATIONS

柄が変わる！？文字盤 ベルトー 体型の電子紙ペーパーウォッチ [FES Watch], posted Sep. 22, 2014, [retrieved Sep. 27, 2017]. Retrieved from Internet, <URL: <https://www.makuake.com/project/fes-watch/>>.\*

(Continued)

*Primary Examiner* — Barbara Fox

*Assistant Examiner* — Kristin E Reed

(74) *Attorney, Agent, or Firm* — Michael Best and Friedrich LLP

(57) **CLAIM**

The ornamental design for a wearable device, as shown and described.

**DESCRIPTION**

FIG. 1 is a perspective view of a wearable device showing our new design;  
 FIG. 2 is a front elevational view thereof;  
 FIG. 3 is a rear elevational view thereof;  
 FIG. 4 is a left side elevational view thereof;  
 FIG. 5 is a right side elevational view thereof;  
 FIG. 6 is a top plan view thereof; and,  
 FIG. 7 is a bottom plan view thereof.

**1 Claim, 4 Drawing Sheets**

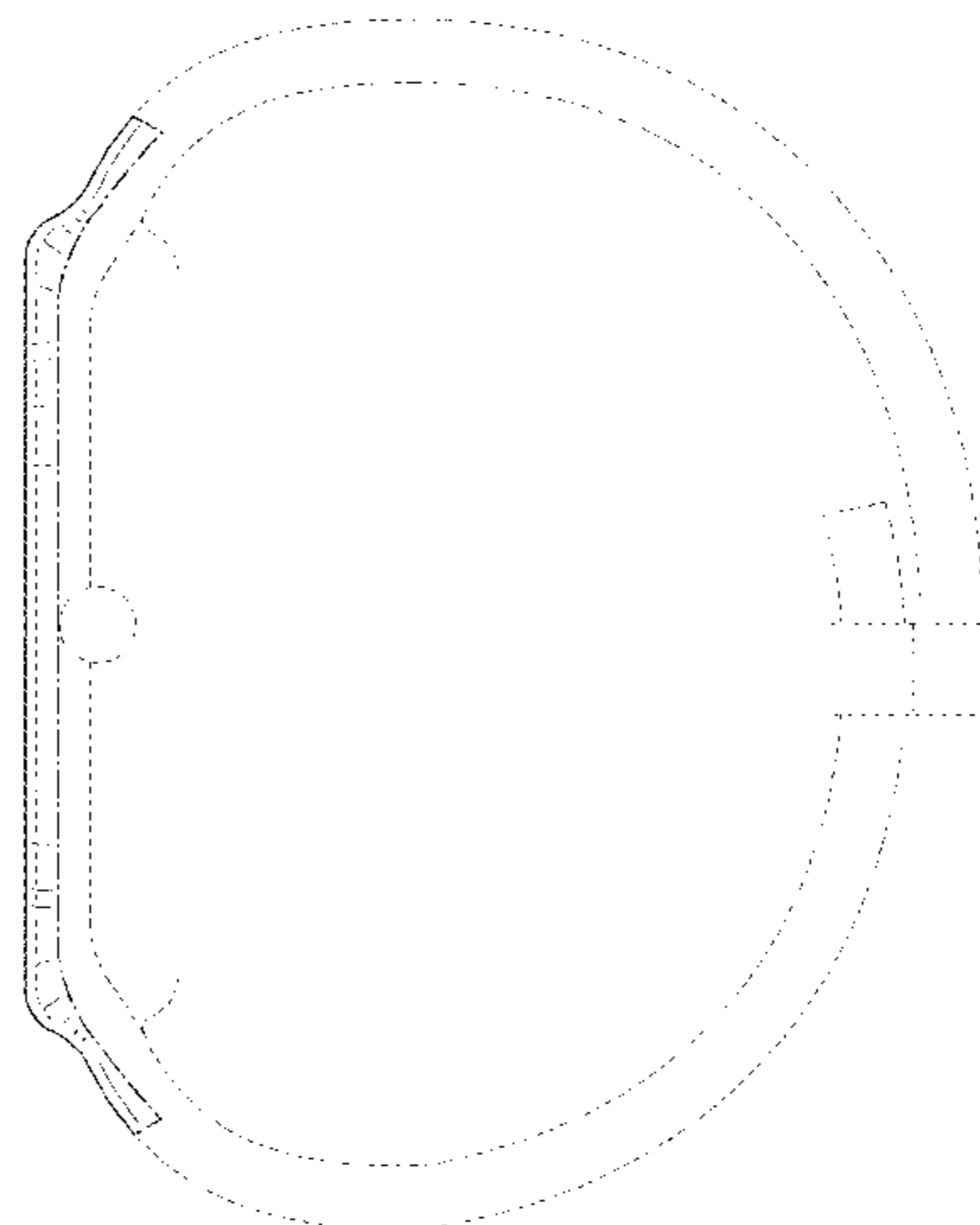
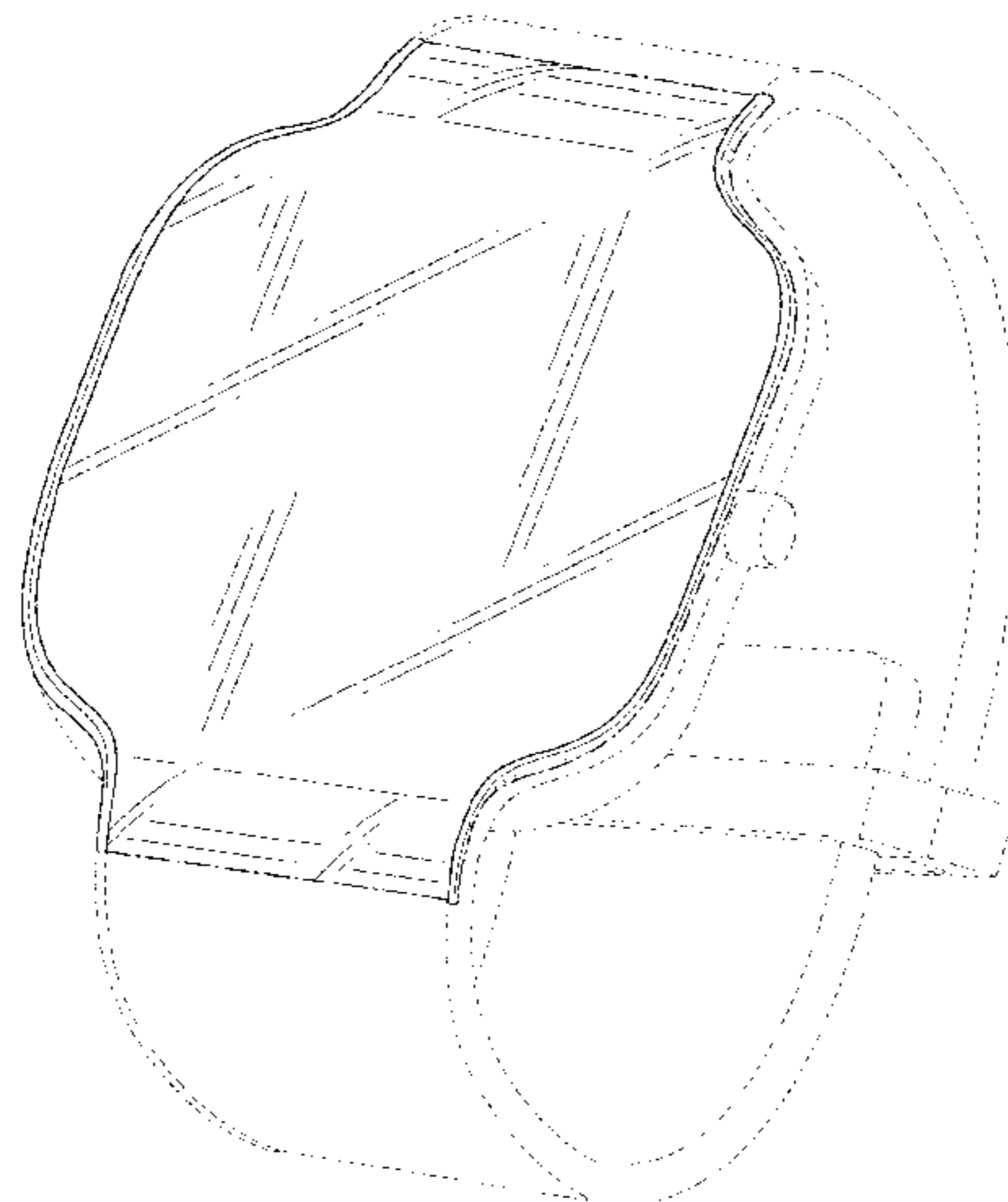

(58) **Field of Classification Search**  
 CPC .. 1/6058; Y02B 60/1217; H04B 1/385; H04B  
 1/3888; H04B 1/3833; A44C 5/00  
 See application file for complete search history.

D738,749 S \* 9/2015 Bibl ..... D10/32  
 D749,965 S 2/2016 Lutgen  
 D752,579 S \* 3/2016 Lee ..... D14/344  
 D759,622 S \* 6/2016 Dahlberg ..... D10/32  
 D765,072 S \* 8/2016 Kwon ..... D10/38  
 D781,852 S 3/2017 Yu

(56) **References Cited**

U.S. PATENT DOCUMENTS

D361,042 S \* 8/1995 Nanayakkara ..... D10/30  
 D368,433 S 4/1996 Schulze  
 D413,530 S 9/1999 Flury  
 6,388,612 B1 \* 5/2002 Neher ..... G01S 5/0018  
 224/164  
 D503,894 S 4/2005 Tu  
 D513,997 S 1/2006 Wilson  
 D528,928 S \* 9/2006 Burton ..... D10/38  
 D559,125 S 1/2008 Figueiredo  
 D581,811 S 12/2008 Messmer  
 D588,472 S 3/2009 Messmer  
 D631,373 S 1/2011 Mikkelsen  
 D638,725 S \* 5/2011 Morrison ..... D10/39  
 D640,948 S 7/2011 Quigley  
 D645,360 S \* 9/2011 Kiser ..... D10/32  
 D653,968 S 2/2012 Blank  
 D653,969 S 2/2012 Jorst  
 D672,667 S \* 12/2012 Mix ..... D10/65  
 D687,736 S 8/2013 Wycoff  
 D695,749 S 12/2013 Hirano  
 D701,504 S \* 3/2014 Christopher ..... D14/344  
 D708,980 S \* 7/2014 Brantman ..... D10/128  
 D709,873 S \* 7/2014 Aumiller ..... D14/344  
 D709,874 S 7/2014 Aumiller  
 D709,875 S 7/2014 Aumiller  
 D710,570 S 8/2014 Zieth  
 D711,872 S 8/2014 Aumiller  
 D719,123 S \* 12/2014 Park ..... D10/38  
 D724,047 S \* 3/2015 Kim ..... D10/38  
 D729,654 S 5/2015 Nuovo  
 D731,455 S 6/2015 Park  
 D734,331 S \* 7/2015 Wu ..... D14/344  
 D738,748 S 9/2015 Bibl

OTHER PUBLICATIONS

Sony FES Watch Re-Introduces You to E-Ink, posted Nov. 28, 2014, [retrieved Sep. 27, 2017]. Retrieved from Internet, <URL: <http://www.ablogtowatch.com/sony-fes-watch-re-introduces-a-ink/>>.\*  
 Rip Curl Women's A2550G-BLU Square Sport Watch with Silicone Coating, posted Mar. 29, 2012, [retrieved Sep. 27, 2017]. Retrieved from Internet, <URL: <https://www.amazon.com/Rip-Curl-A2550G-BLU-Silicone-Coating/dp/B007PNT8SU>>.\*  
 Vestal Men's The Brig Watch, posted Oct. 15, 2010, [retrieved Sep. 27, 2017]. Retrieved from Internet, <URL: <https://www.amazon.com/Vestal-Mens-BRG001-Train-Watch/dp/B0047DYZHU>>.\*  
 Decision on Appeal No. 2015-15754 issued in Japanese Application No. D2014-019437, dated Jan. 19, 2016.  
 柄が変わる！？文字盤ベルト 一体型の電子ペーパーウォッチ [FES Watch], posted Sep. 22, 2014, [retrieved Mar. 23, 2017]. Retrieved from Internet, <URL: <https://www.makuake.com/project/fes-watch/>>.\*  
 Sony FES Watch Re-Introduces You To E-Ink, posted Nov. 28, 2014, [retrieved Mar. 23, 2017]. Retrieved from Internet, <URL: <http://www.ablogtowatch.com/sony-fes-watch-re-introduces-e-ink/>>.\*  
 [GadgetStyle] Touch Skin OLEO Watch, die Chameleon-Uhr, posted Jul. 28, 2012, [retrieved Mar. 23, 2017]. Retrieved from Internet, <URL: <http://www.techfieber.de/2012/07/28/gadgetstyle-touch-skin-die-chameleon-uhr/>>.\*  
 Apple's iWatch expected to be even bigger than the iPad in its first year, posted Jun. 10, 2014, [retrieved Mar. 23, 2017]. Retrieved from Internet, <URL: <http://bgr.com/2014/06/10/apple-iwatch-price-and-launch/>>.\*

\* cited by examiner

FIG.1

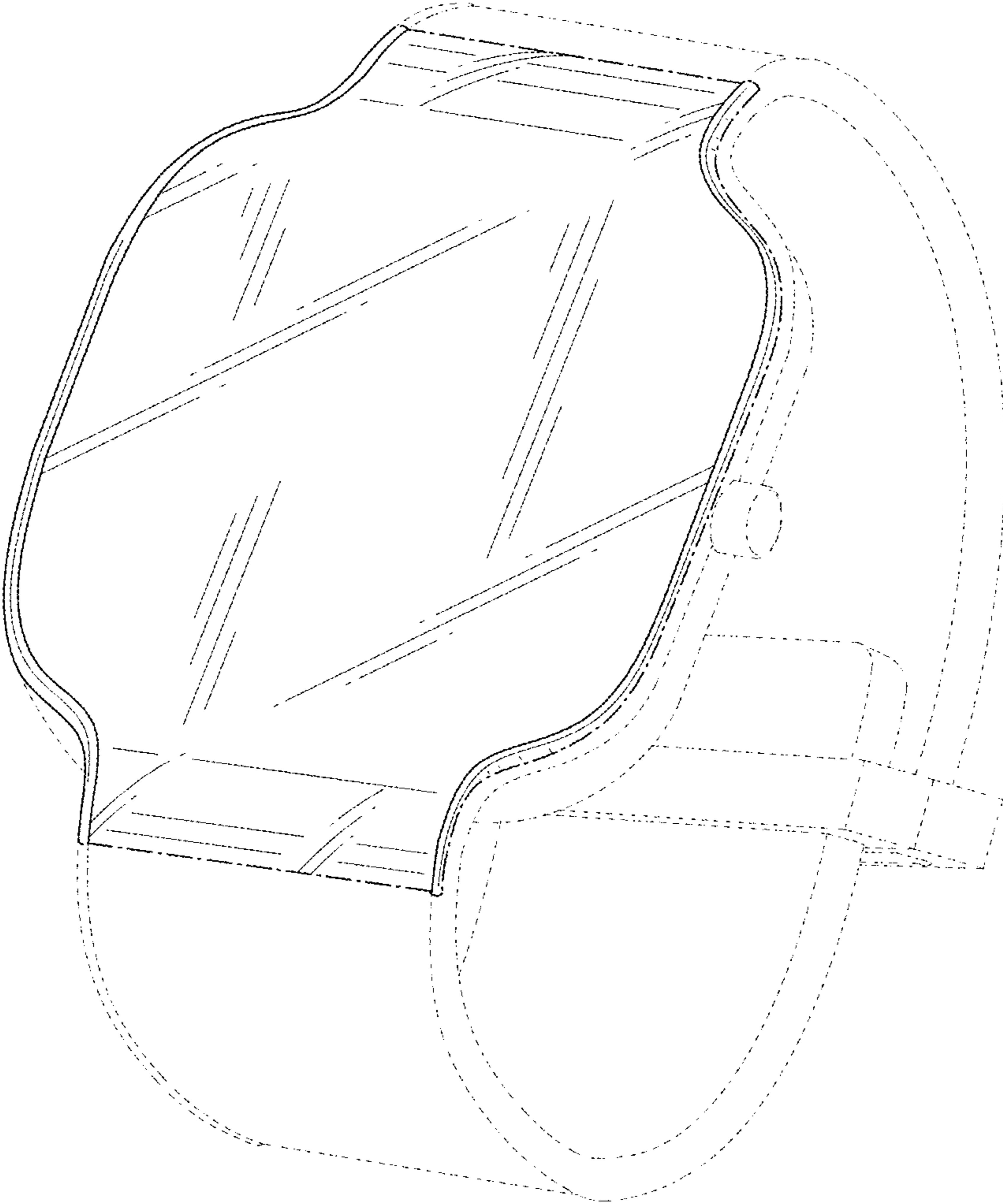

FIG.3

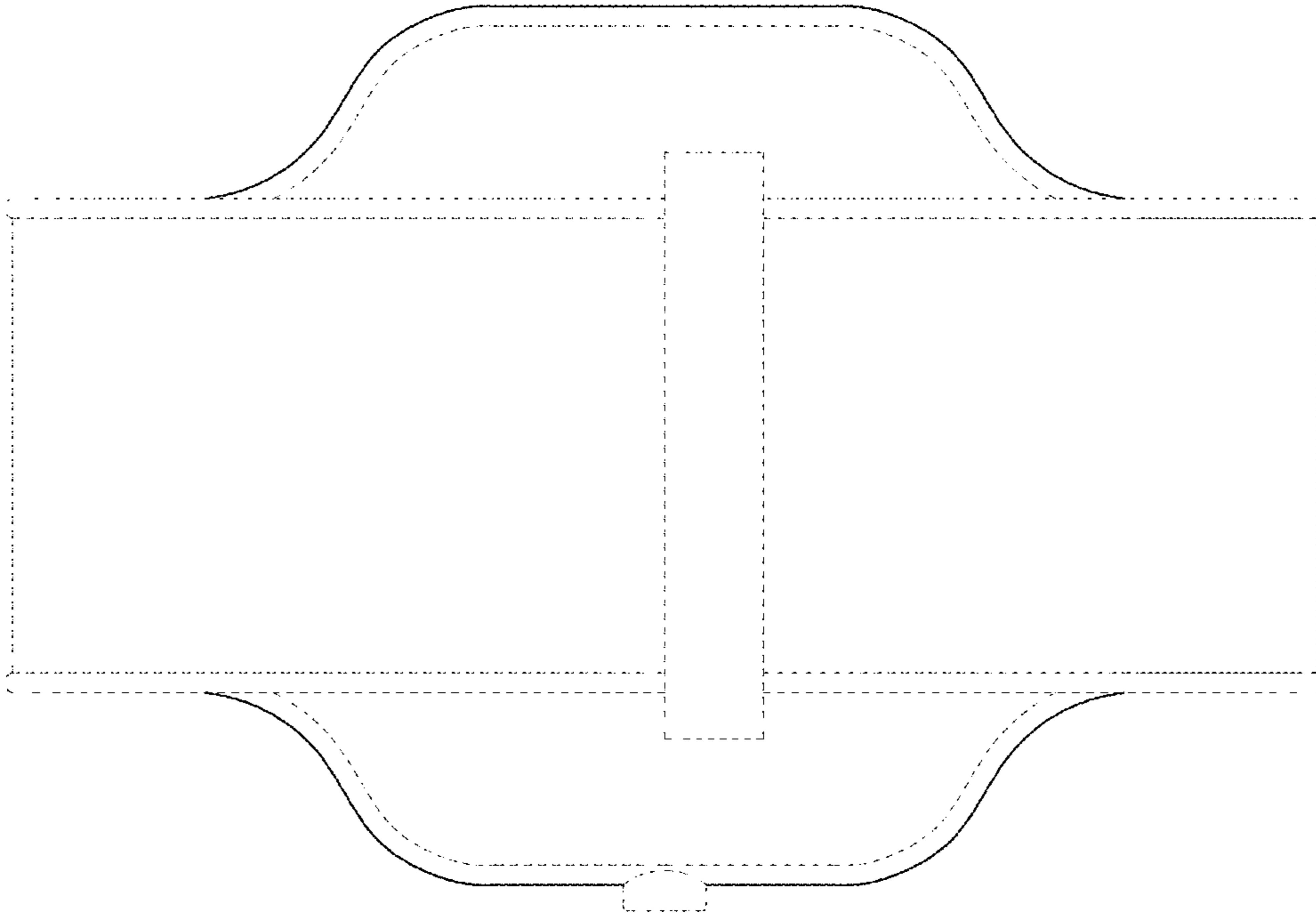

FIG.2

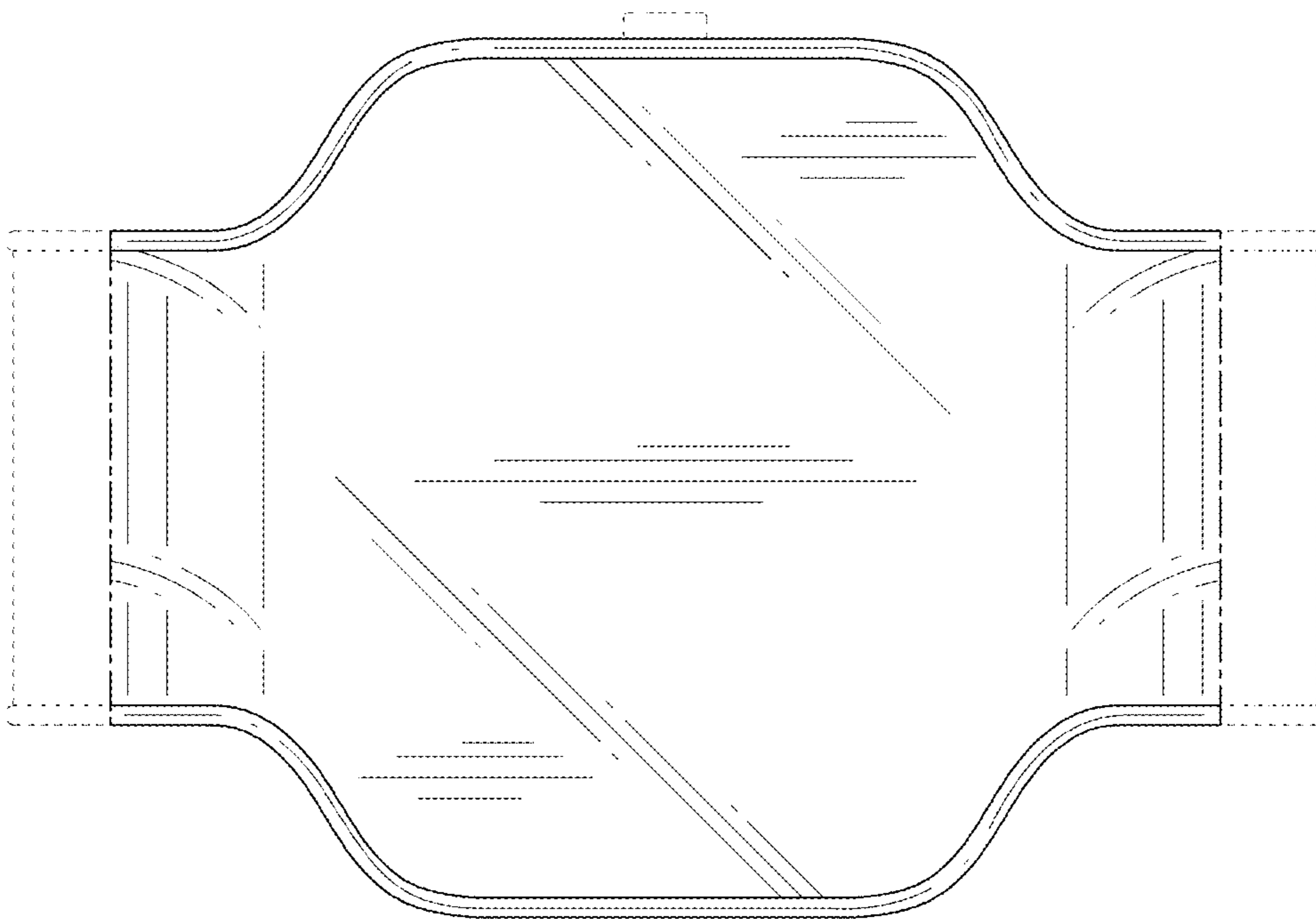



FIG.5

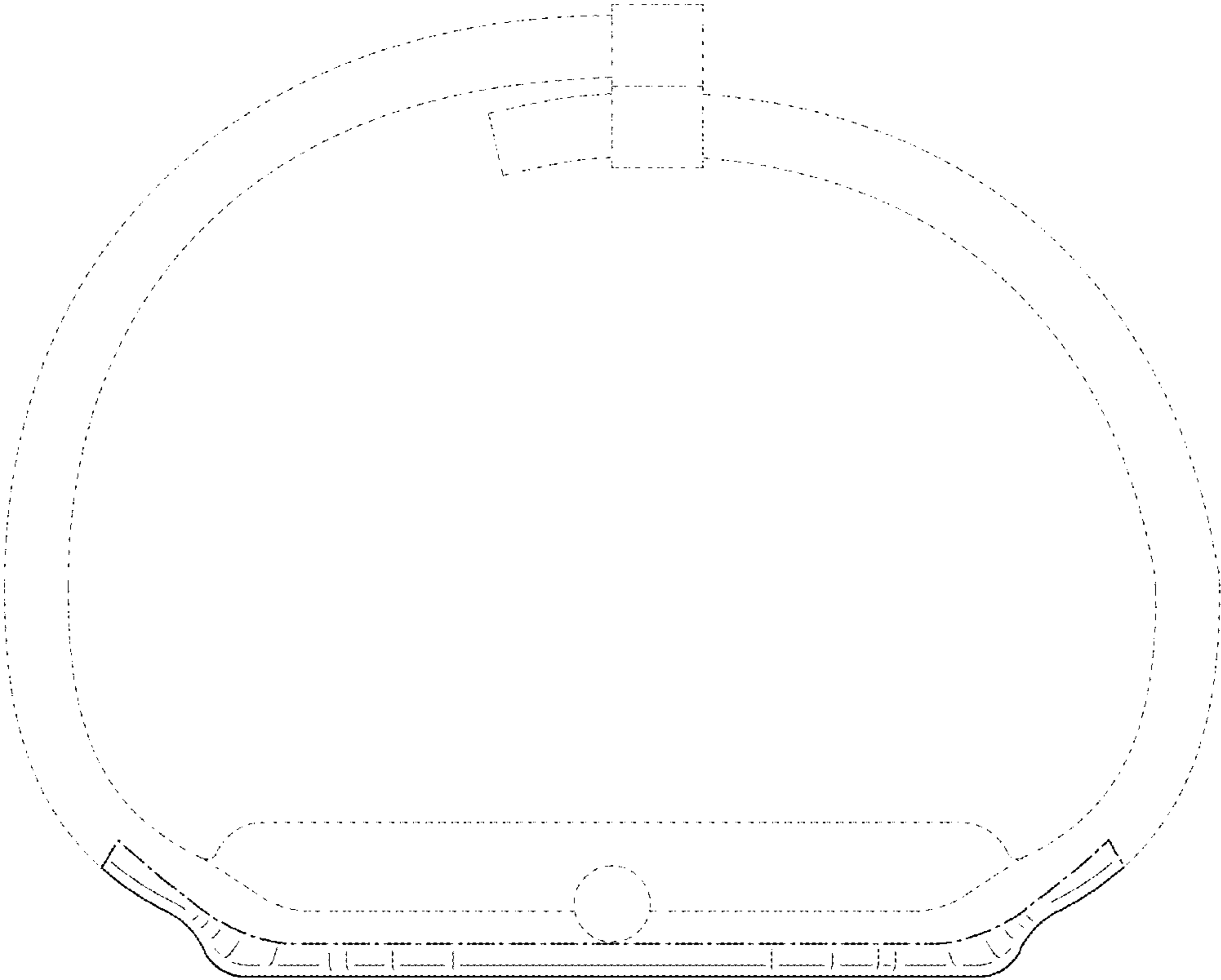

FIG.4

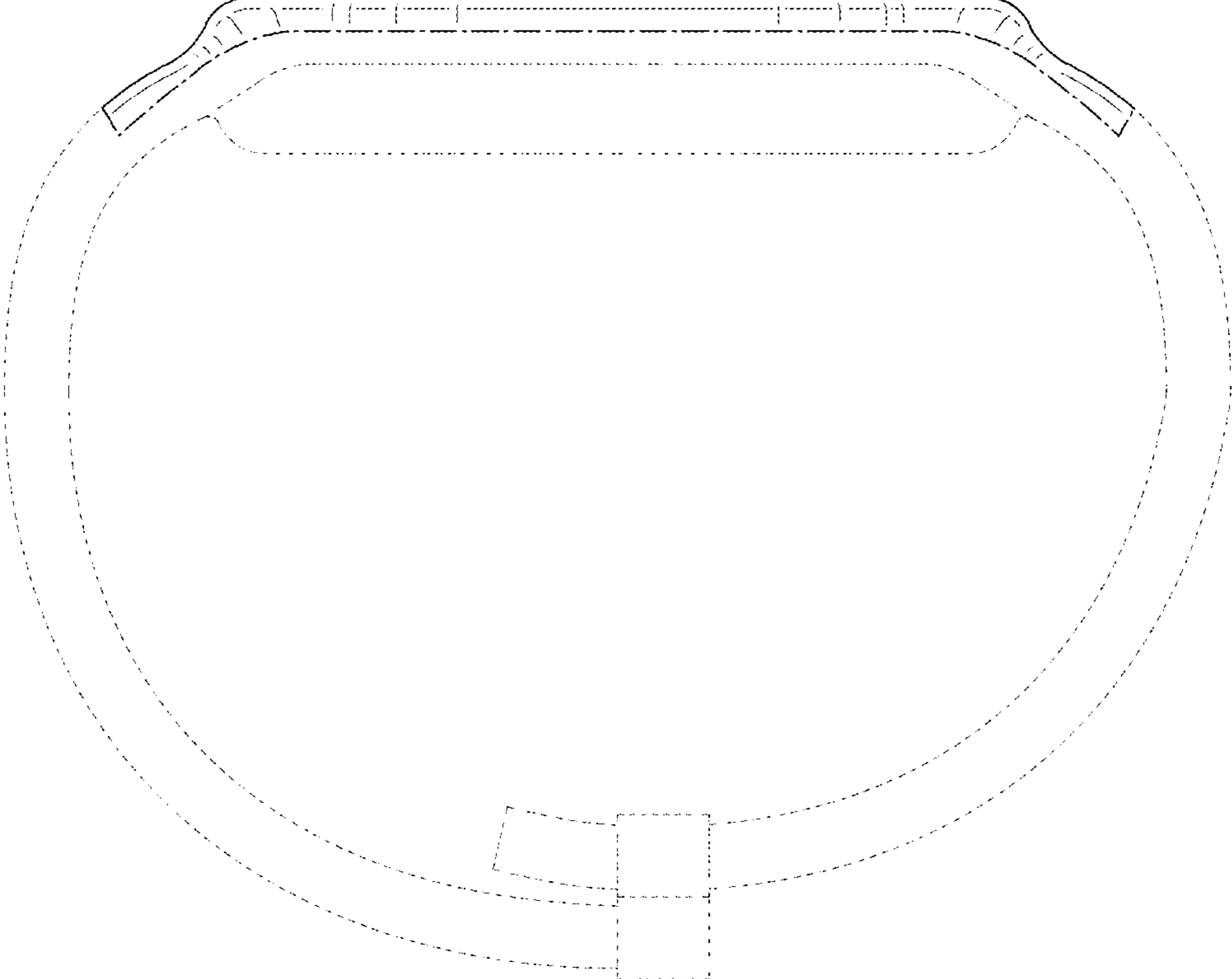

FIG.7

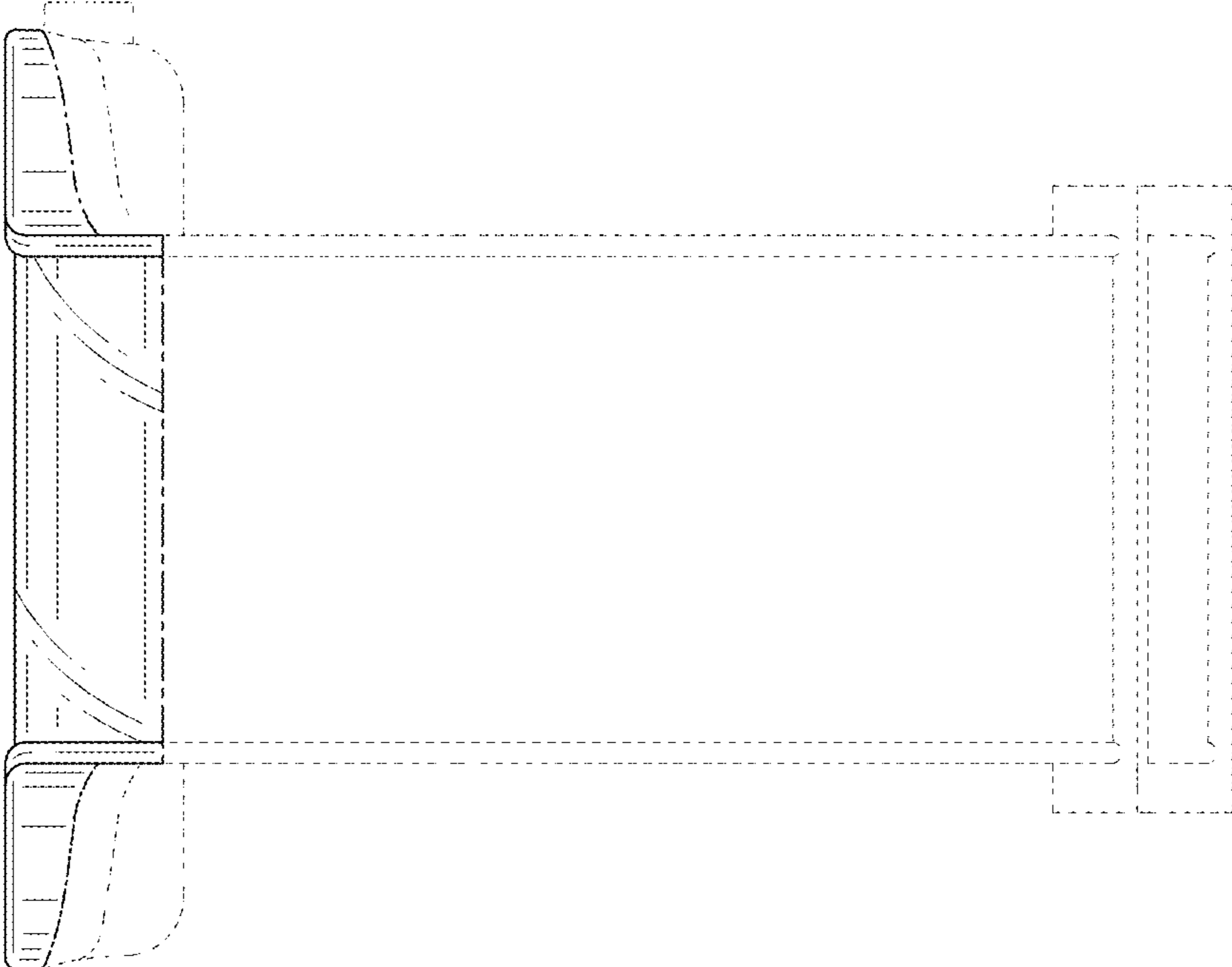

FIG.6

