



US00D810726S

(12) **United States Design Patent** (10) **Patent No.:** **US D810,726 S**  
**Chou et al.** (45) **Date of Patent:** **\*\* Feb. 20, 2018**

(54) **PORTABLE ELECTRONIC DEVICE**

(71) Applicant: **HTC Corporation**, Taoyuan (TW)

(72) Inventors: **Chin-Wei Chou**, Taoyuan (TW);  
**Yi-Shen Wang**, Taoyuan (TW);  
**Chien-Hsin Huang**, Taoyuan (TW);  
**Meng-Sheng Chiang**, Taoyuan (TW);  
**Lee-Wei Chen**, Taoyuan (TW);  
**Yien-chun Kuo**, Taoyuan (TW);  
**Hung-Yu Chen**, Taoyuan (TW)

(73) Assignee: **HTC Corporation**, Taoyuan (TW)

(\*\*) Term: **15 Years**

(21) Appl. No.: **29/573,395**

(22) Filed: **Aug. 5, 2016**

(51) **LOC (11) Cl.** ..... **14-03**

(52) **U.S. Cl.**  
USPC ..... **D14/248**

(58) **Field of Classification Search**

USPC ..... D14/138 G, 138 AD, 341, 138 R, 496,  
D14/203.1, 203.3, 203.5, 203.7, 248;  
455/575.1, 556.2; D21/517, 329;  
361/679.3, 679.56  
CPC . G06F 1/1626; H04M 1/0266; H04M 1/0264;  
H04M 1/0202  
See application file for complete search history.

(56) **References Cited**

**U.S. PATENT DOCUMENTS**

D597,067 S \* 7/2009 Oh ..... D14/203.7  
D681,032 S \* 4/2013 Akana ..... D14/341  
D685,365 S \* 7/2013 Murchison ..... D14/250  
8,796,611 B2 \* 8/2014 Wittenberg ..... H03K 17/9631  
174/520  
8,953,083 B2 \* 2/2015 Hegde ..... H04M 1/0264  
348/335  
D733,693 S \* 7/2015 Wang ..... D14/248  
D739,391 S \* 9/2015 Chen ..... D14/248  
D741,279 S \* 10/2015 Tai ..... D14/138 G

(Continued)

**OTHER PUBLICATIONS**

HTC Desire 10 Lifestyle, announced Sep. 2016, [online], [site visited Sep. 16, 2017]. Available from Internet, <URL: [http://www.gsmarena.com/htc\\_desire\\_10\\_lifestyle-pictures-8276.php](http://www.gsmarena.com/htc_desire_10_lifestyle-pictures-8276.php)>.\*  
HTC Desire 10 Pro, announced Dec. 2016, [online], [site visited Sep. 16, 2017]. Available from Internet, <URL: [http://www.gsmarena.com/htc\\_desire\\_10\\_pro-pictures-8277.php](http://www.gsmarena.com/htc_desire_10_pro-pictures-8277.php)>.\*  
Alcatel PulseMix, announced Aug. 2017, [online], [site visited Sep. 16, 2017]. Available from Internet, <URL: [http://www.gsmarena.com/alcatel\\_pulsemix-pictures-8803.php](http://www.gsmarena.com/alcatel_pulsemix-pictures-8803.php)>.\*  
Archos 50b Cobalt, announced Jan. 2017, [online], [site visited Sep. 16, 2017]. Available from Internet, <URL: [http://www.gsmarena.com/archos\\_50b\\_cobalt-pictures-8546.php](http://www.gsmarena.com/archos_50b_cobalt-pictures-8546.php)>.\*  
Asus Zenfone Live ZB501KL, announced Mar. 2017, [online], [site visited Sep. 16, 2017]. Available from Internet, <URL: [http://www.gsmarena.com/asus\\_zenfone\\_live\\_zb501kl-pictures-8579.php](http://www.gsmarena.com/asus_zenfone_live_zb501kl-pictures-8579.php)>.\*  
Panasonic Eluga Ray, announced May 2017, [online], [site visited Sep. 16, 2017]. Available from Internet, <URL: [http://www.gsmarena.com/panasonic\\_eluga\\_ray-pictures-8688.php](http://www.gsmarena.com/panasonic_eluga_ray-pictures-8688.php)>.\*

(Continued)

*Primary Examiner* — Jeffrey D Asch

(74) *Attorney, Agent, or Firm* — JCIPRNET

(57) **CLAIM**

The ornamental design for a portable electronic device, as shown and described.

**DESCRIPTION**

FIG. 1 is a perspective view of a first embodiment of a portable electronic device in accordance with our new design;  
FIG. 2 is another perspective view thereof;  
FIG. 3 is a front view thereof;  
FIG. 4 is a rear view thereof;  
FIG. 5 is a left side view thereof;  
FIG. 6 is a right side view thereof;  
FIG. 7 is a top view thereof;  
FIG. 8 is a bottom view thereof;  
FIG. 9 is a perspective view of a second embodiment of a portable electronic device in accordance with our new design;  
FIG. 10 is another perspective view thereof;  
FIG. 11 is a front view thereof;  
FIG. 12 is a rear view thereof;  
FIG. 13 is a left side view thereof;  
FIG. 14 is a right side view thereof;  
FIG. 15 is a top view thereof; and,  
FIG. 16 is a bottom view thereof.

The portions of the portable electronic device shown in broken lines form no part of the claimed design.

**1 Claim, 12 Drawing Sheets**

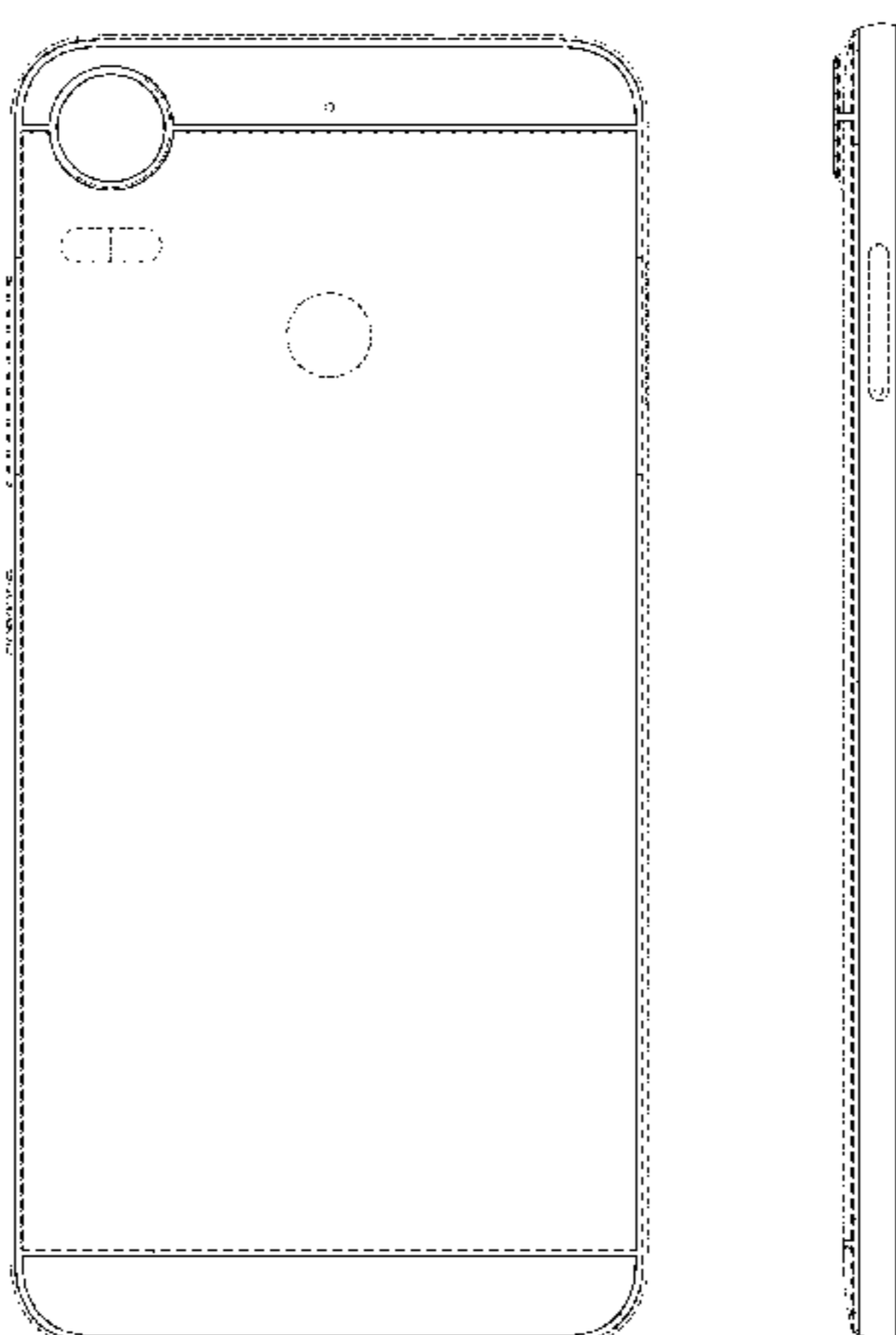

(56)

References Cited

U.S. PATENT DOCUMENTS

D746,275 S \* 12/2015 Mohammad ..... D14/250  
 D756,951 S \* 5/2016 Kim ..... D14/138 G  
 D756,952 S \* 5/2016 Simonian ..... D14/138 G  
 D761,239 S \* 7/2016 Kim ..... D14/250  
 D769,850 S \* 10/2016 Lee ..... D14/248  
 9,462,113 B2 \* 10/2016 Hung ..... H04M 1/72566  
 D770,411 S \* 11/2016 Zhang ..... D14/138 G  
 D775,097 S \* 12/2016 Husgafvel ..... D14/138 G  
 D777,129 S \* 1/2017 Xu ..... D14/138 G  
 D780,146 S \* 2/2017 Song ..... D14/248  
 D780,748 S \* 3/2017 Wang ..... D14/138 G  
 D781,807 S \* 3/2017 Hubbard ..... D14/138 G  
 D782,435 S \* 3/2017 Yuan ..... D14/138 AA  
 9,591,111 B1 \* 3/2017 Holmes ..... H04N 5/2254  
 D783,602 S \* 4/2017 Akana ..... D14/341  
 D784,282 S \* 4/2017 Kim ..... D14/138 G  
 D788,727 S \* 6/2017 Kuo ..... D14/138 G  
 D788,732 S \* 6/2017 Choe ..... D14/138 G  
 D789,314 S \* 6/2017 Lee ..... D14/138 G  
 D791,732 S \* 7/2017 Xu ..... D14/138 G  
 D792,366 S \* 7/2017 Zhang ..... D14/138 G  
 D793,982 S \* 8/2017 Seo ..... D14/138 G  
 D796,469 S \* 9/2017 Jin ..... D14/138 G  
 D797,072 S \* 9/2017 Seo ..... D14/138 G  
 D800,716 S \* 10/2017 Akana ..... D14/341  
 D801,296 S \* 10/2017 Kim ..... D14/138 G  
 2014/0284096 A1 \* 9/2014 Wu ..... H05K 5/04  
 174/520  
 2017/0125897 A1 \* 5/2017 Rubin ..... H01Q 21/28  
 2017/0126268 A1 \* 5/2017 Evans ..... H04B 1/3888  
 2017/0179992 A1 \* 6/2017 Yu ..... H04B 1/3888  
 2017/0194696 A1 \* 7/2017 Chang ..... H01Q 1/243

OTHER PUBLICATIONS

Lava A77, announced May 2017, [online], [site visited Sep. 16, 2017]. Available from Internet, <URL: [http://www.gsmarena.com/lava\\_a77-pictures-8692.php](http://www.gsmarena.com/lava_a77-pictures-8692.php)>.\*  
 Blu Studio G Max, announced Nov. 2016, [online], [site visited Sep. 16, 2017]. Available from Internet, <URL: [http://www.gsmarena.com/blu\\_studio\\_g\\_max-pictures-8428.php](http://www.gsmarena.com/blu_studio_g_max-pictures-8428.php)>.\*  
 BlackBerry Keyone, announced Apr. 2017, [online], [site visited Sep. 16, 2017]. Available from Internet, <URL: [http://www.gsmarena.com/blackberry\\_keyone-8508.php](http://www.gsmarena.com/blackberry_keyone-8508.php)>.\*  
 Xolo LT900, announced Oct. 2013, [online], [site visited Sep. 16, 2017]. Available from Internet, <URL: [http://www.gsmarena.com/xolo\\_lt900-pictures-5923.php](http://www.gsmarena.com/xolo_lt900-pictures-5923.php)>.\*  
 HTC Desire 825, announced Apr. 2016, [online], [site visited Sep. 16, 2017]. Available from Internet, <URL: [http://www.gsmarena.com/htc\\_desire\\_825-pictures-7942.php](http://www.gsmarena.com/htc_desire_825-pictures-7942.php)>.\*  
 HTC Desire 820, announced Nov. 2014, [online], [site visited Sep. 16, 2017]. Available from Internet, <URL: [http://www.gsmarena.com/htc\\_desire\\_820-pictures-6636.php](http://www.gsmarena.com/htc_desire_820-pictures-6636.php)>.\*  
 Meizu E2, announced Apr. 2017, [online], [site visited Sep. 16, 2017]. Available from Internet, <URL: [http://www.gsmarena.com/meizu\\_e2-pictures-8659.php](http://www.gsmarena.com/meizu_e2-pictures-8659.php)>.\*  
 Gionee 10C, announced Jul. 2017, [online], [site visited Sep. 16, 2017]. Available from Internet, <URL: [http://www.gsmarena.com/gionee\\_s10c-pictures-8702.php](http://www.gsmarena.com/gionee_s10c-pictures-8702.php)>.\*  
 Apple iPhone 7, announced Sep. 2016, [online], [site visited Sep. 16, 2017]. Available from Internet, <URL: [http://www.gsmarena.com/apple\\_iphone\\_7-pictures-8064.php](http://www.gsmarena.com/apple_iphone_7-pictures-8064.php)>.\*  
 "R9", <http://www.oppo.com/au/smartphone-r9>, OPPO Mobile Communications Co., Ltd.

\* cited by examiner

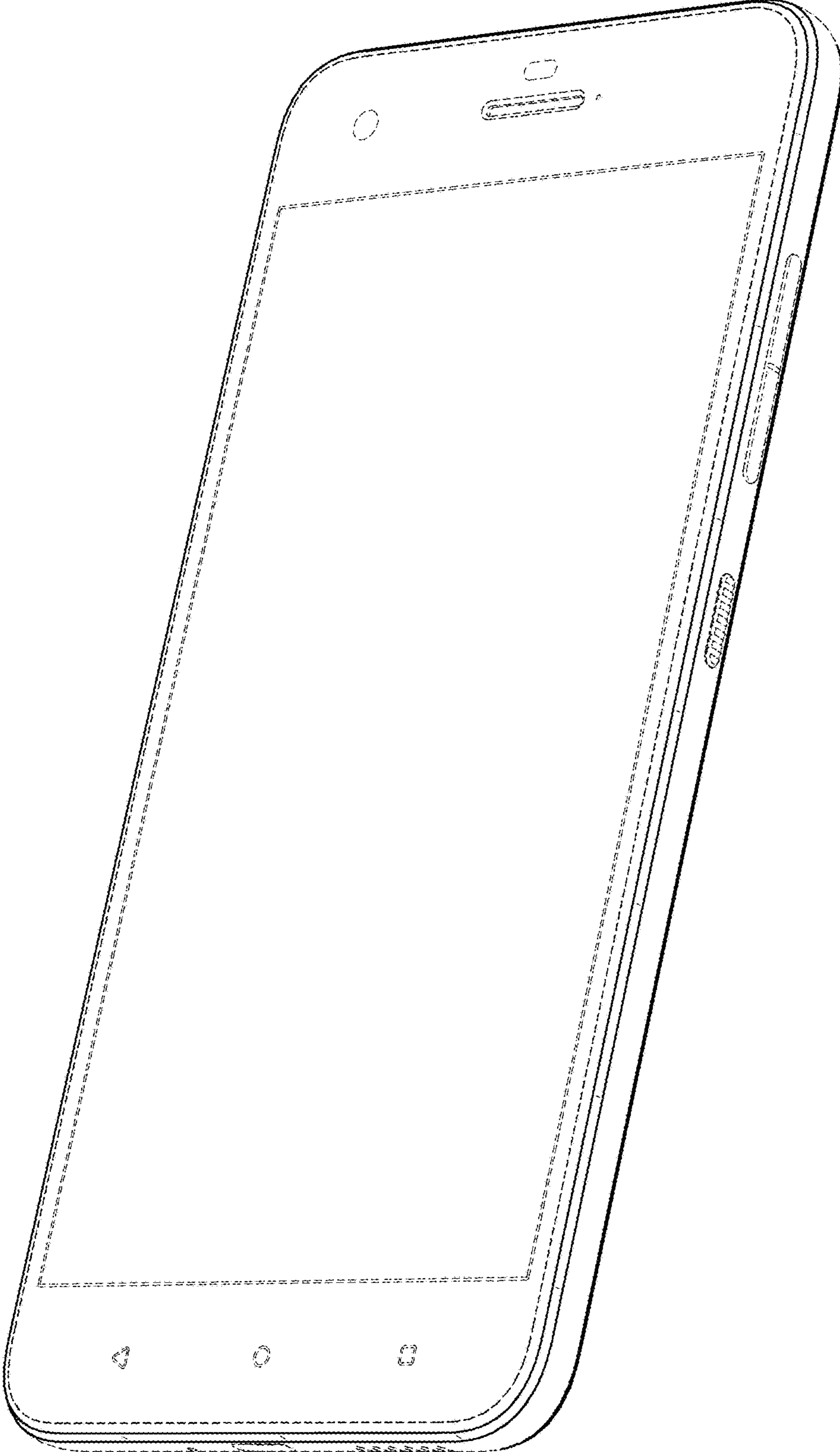

FIG. 1



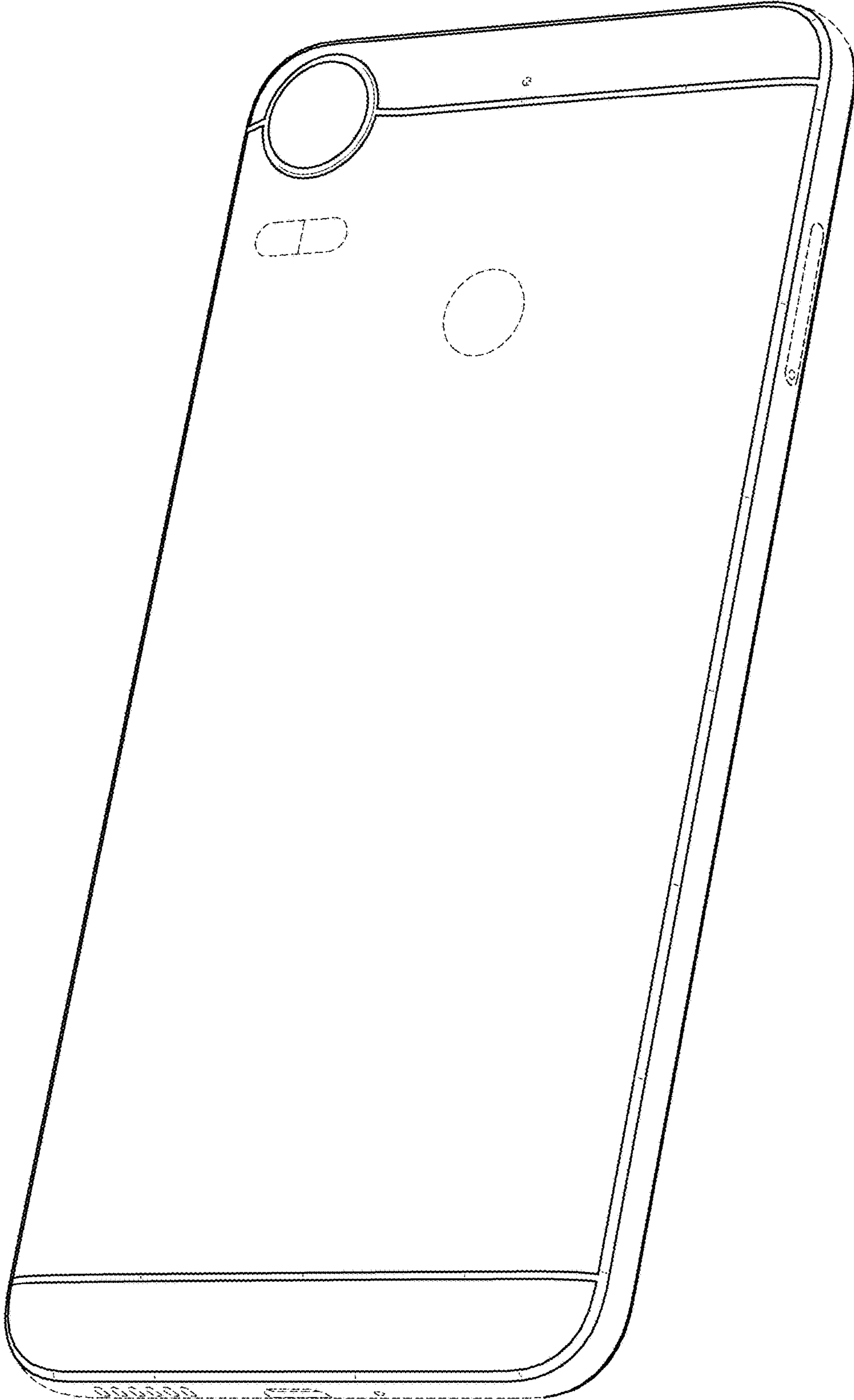

FIG. 2

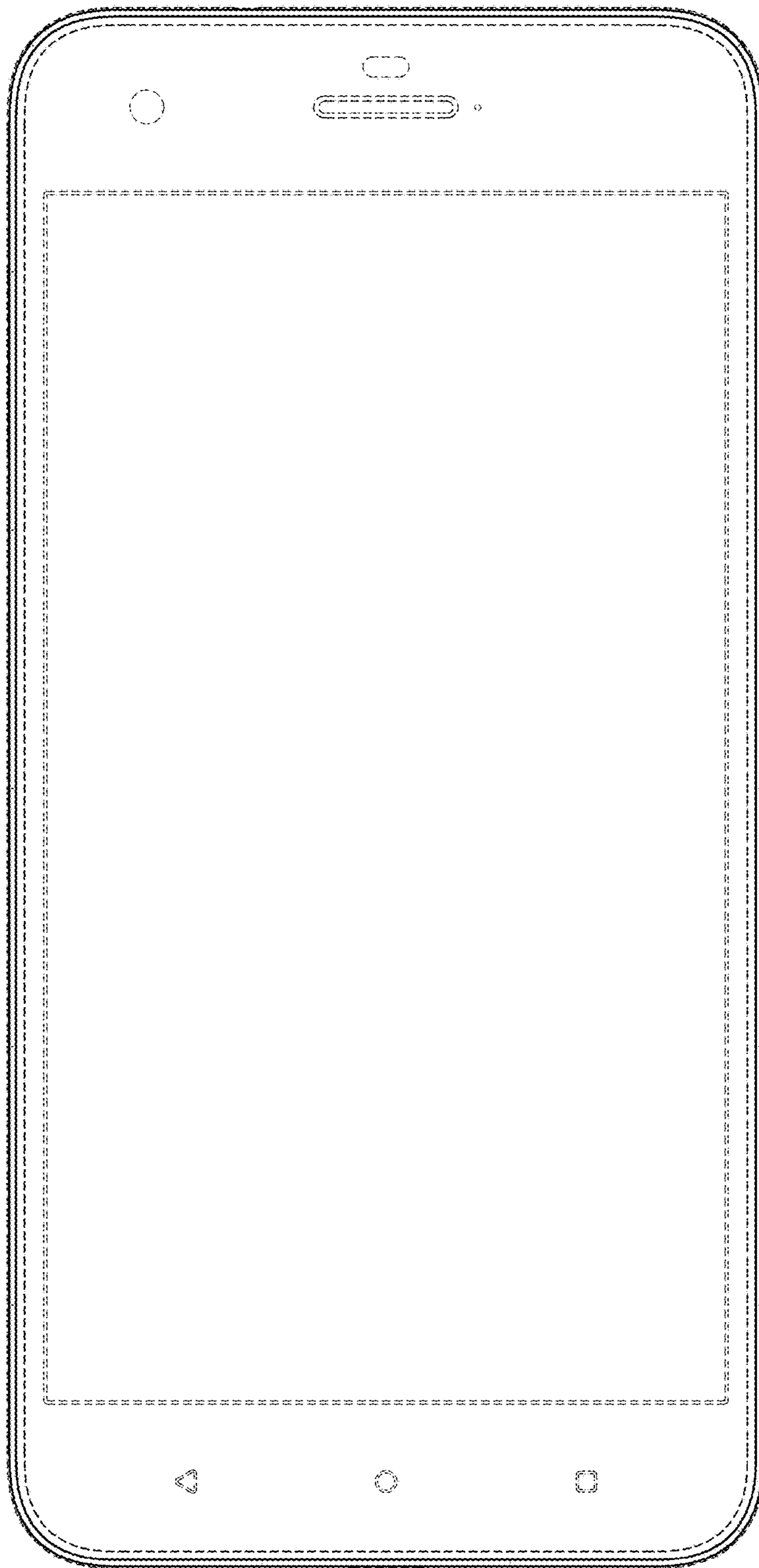

FIG. 3

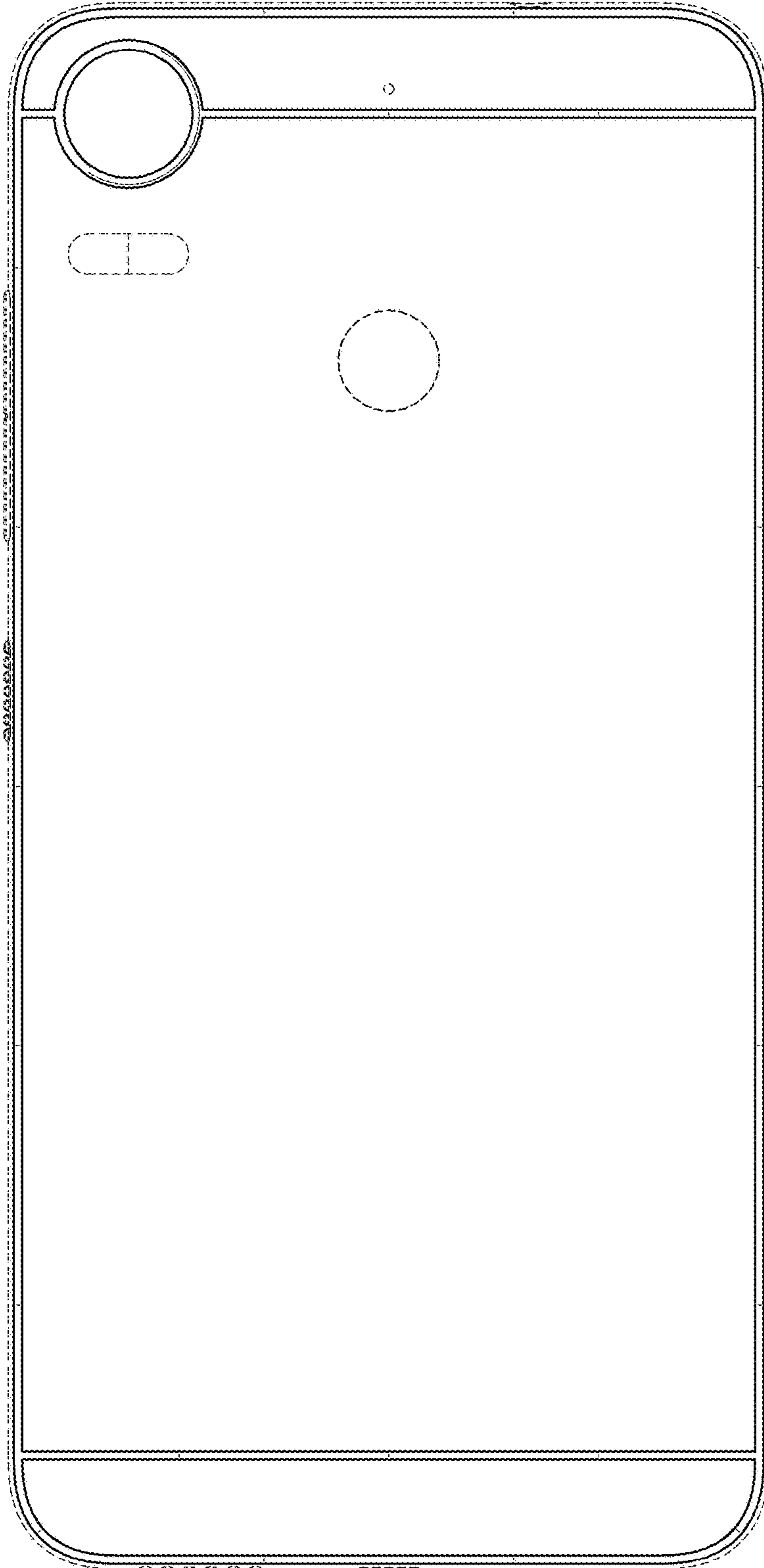

FIG. 4

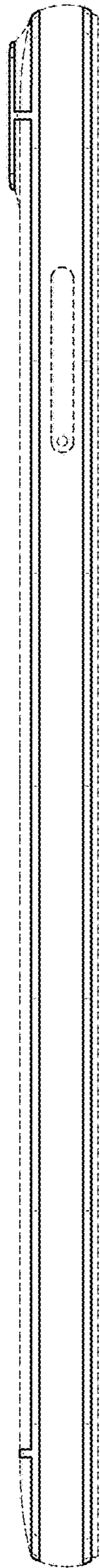

FIG. 5

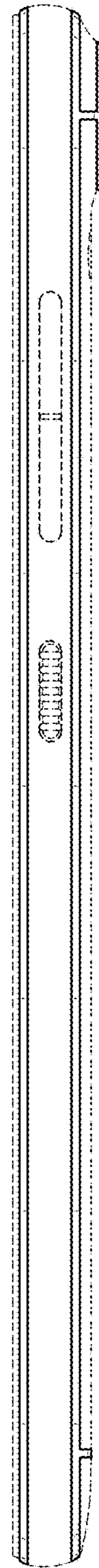

FIG. 6

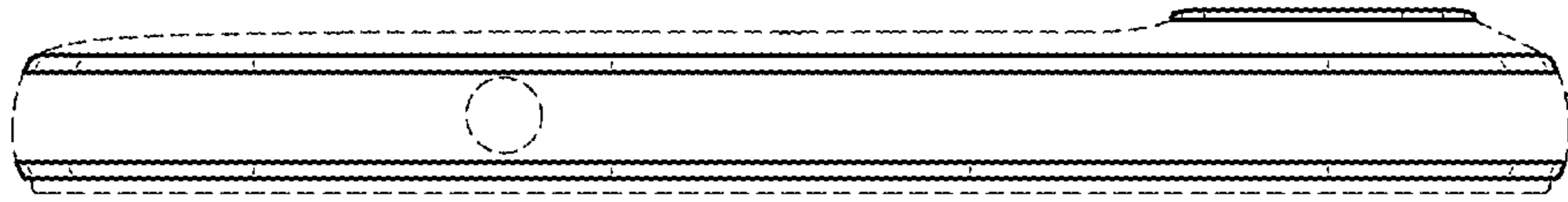

FIG. 7

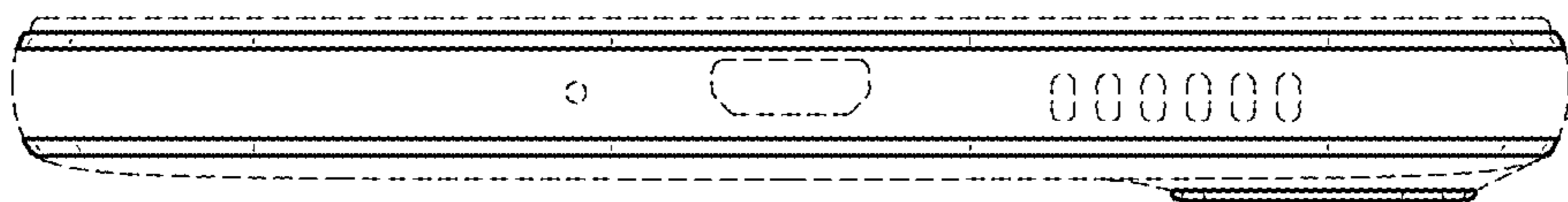

FIG. 8



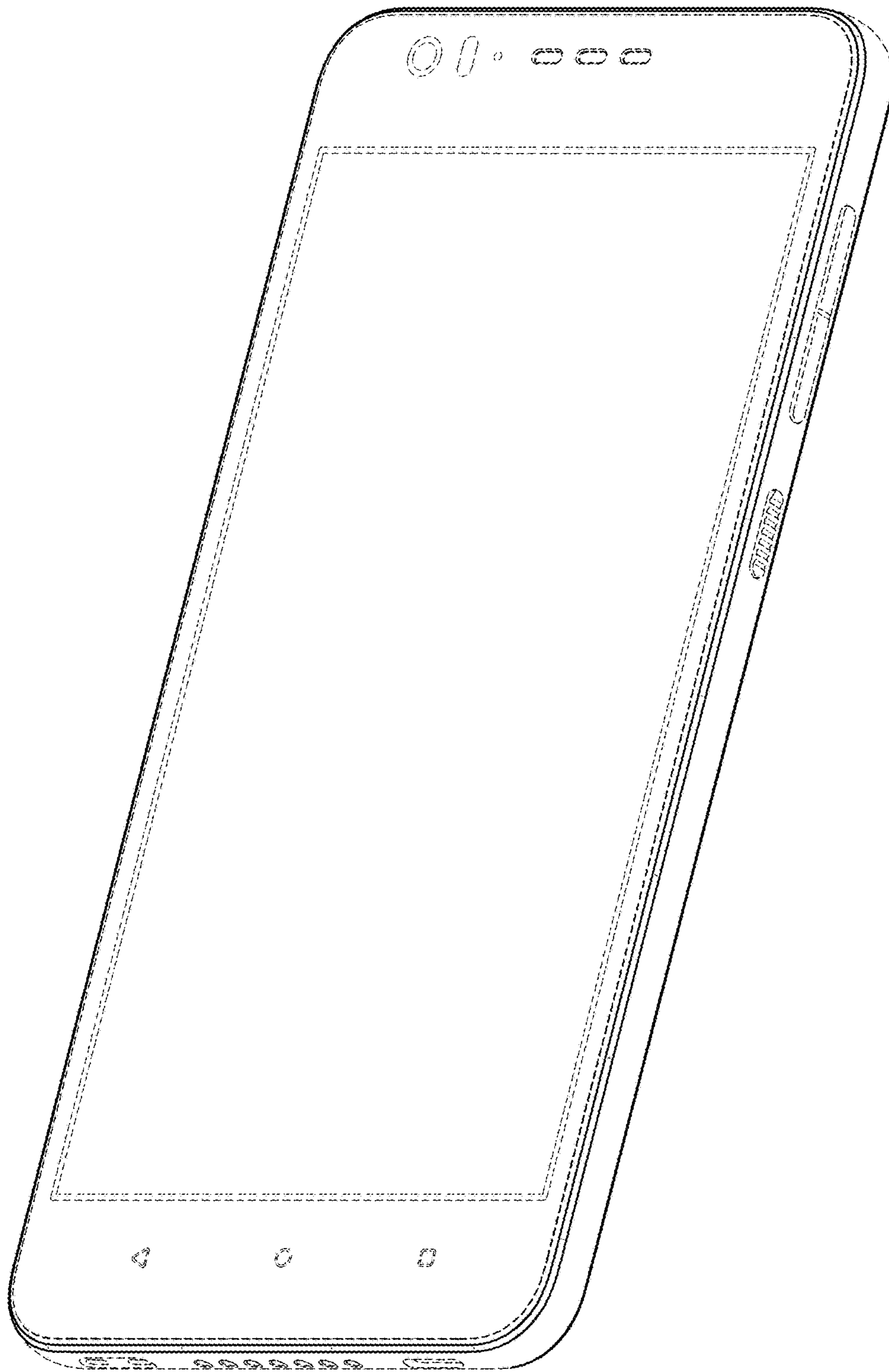

FIG. 9

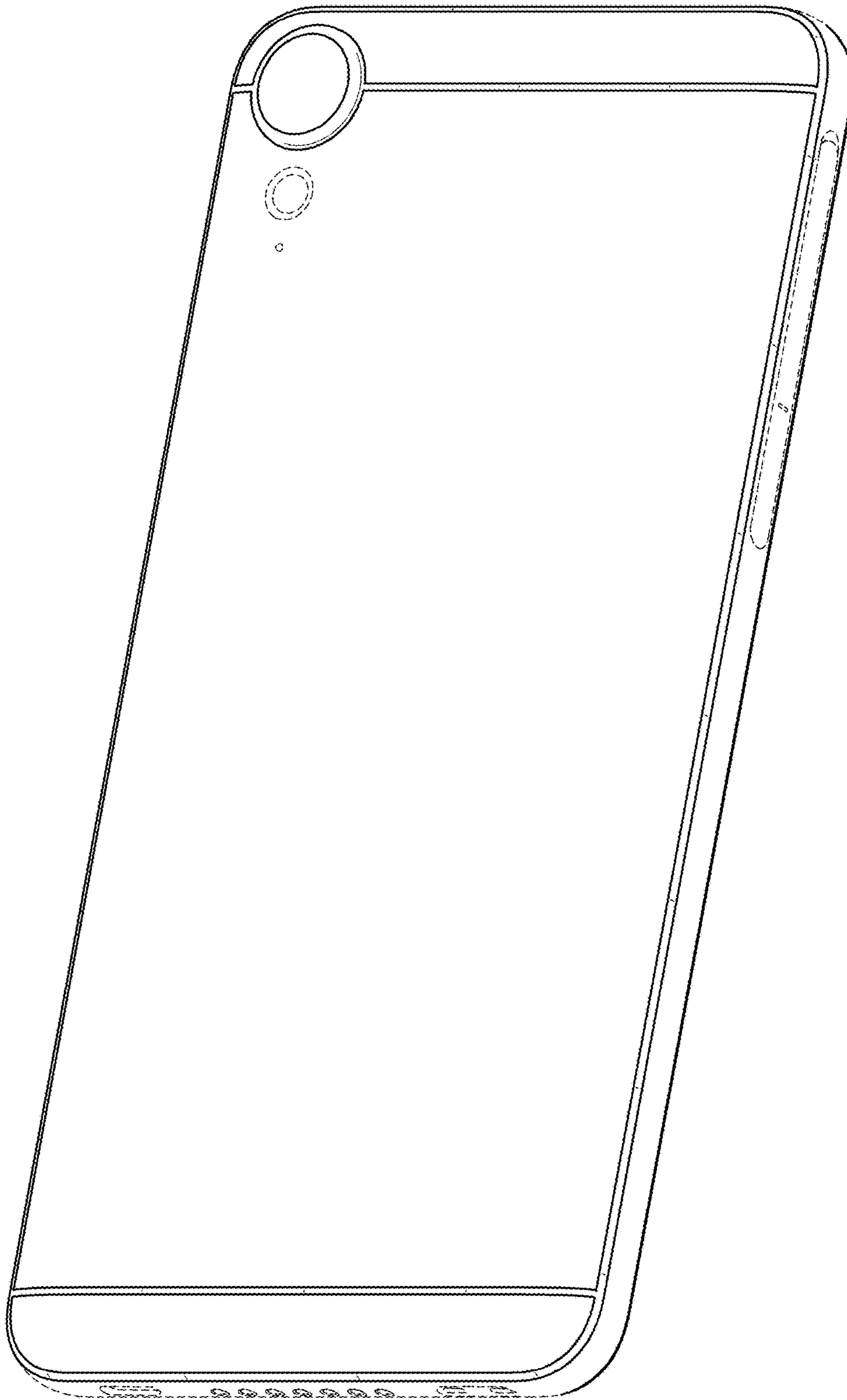

FIG. 10

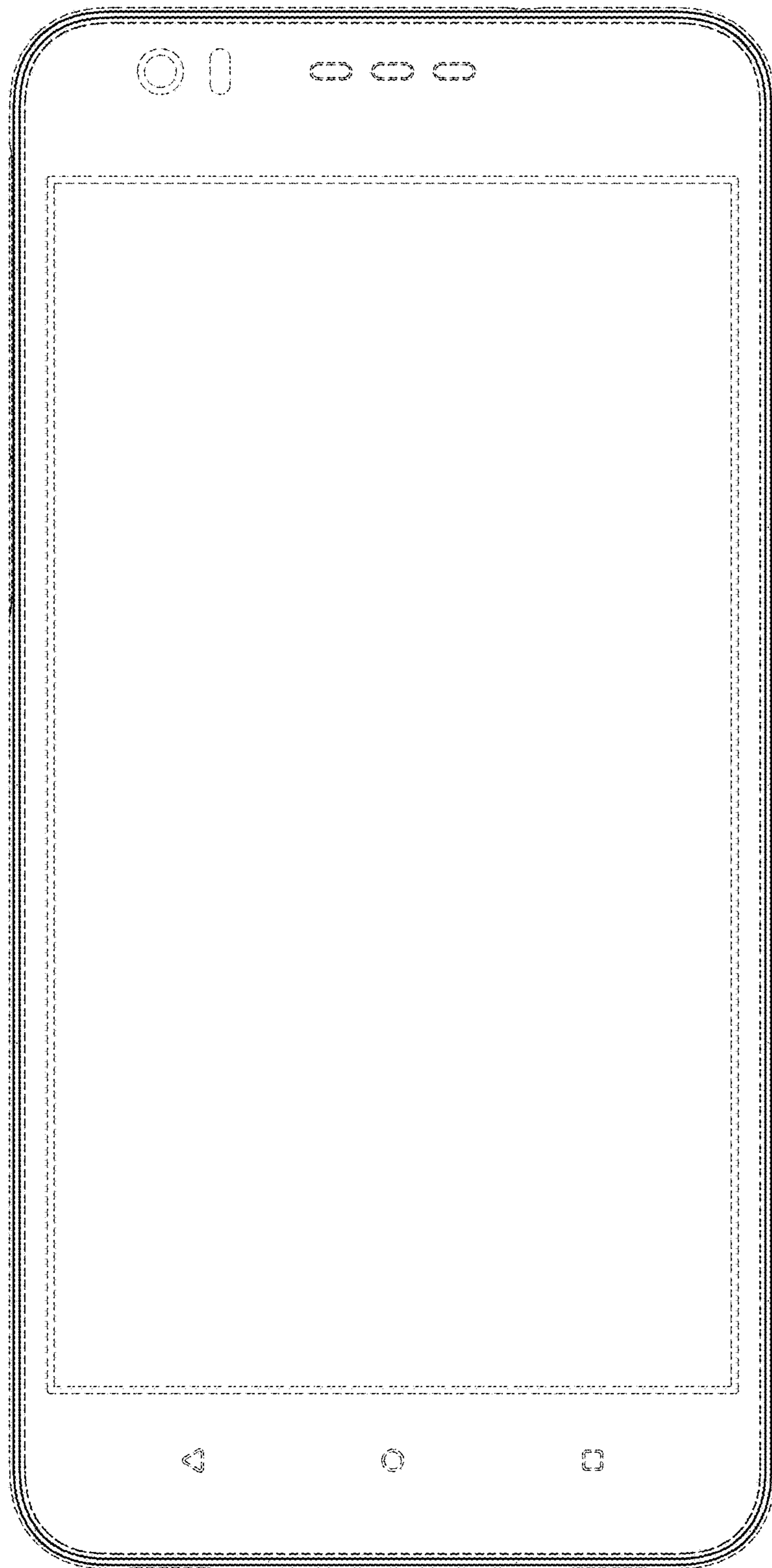

FIG. 11

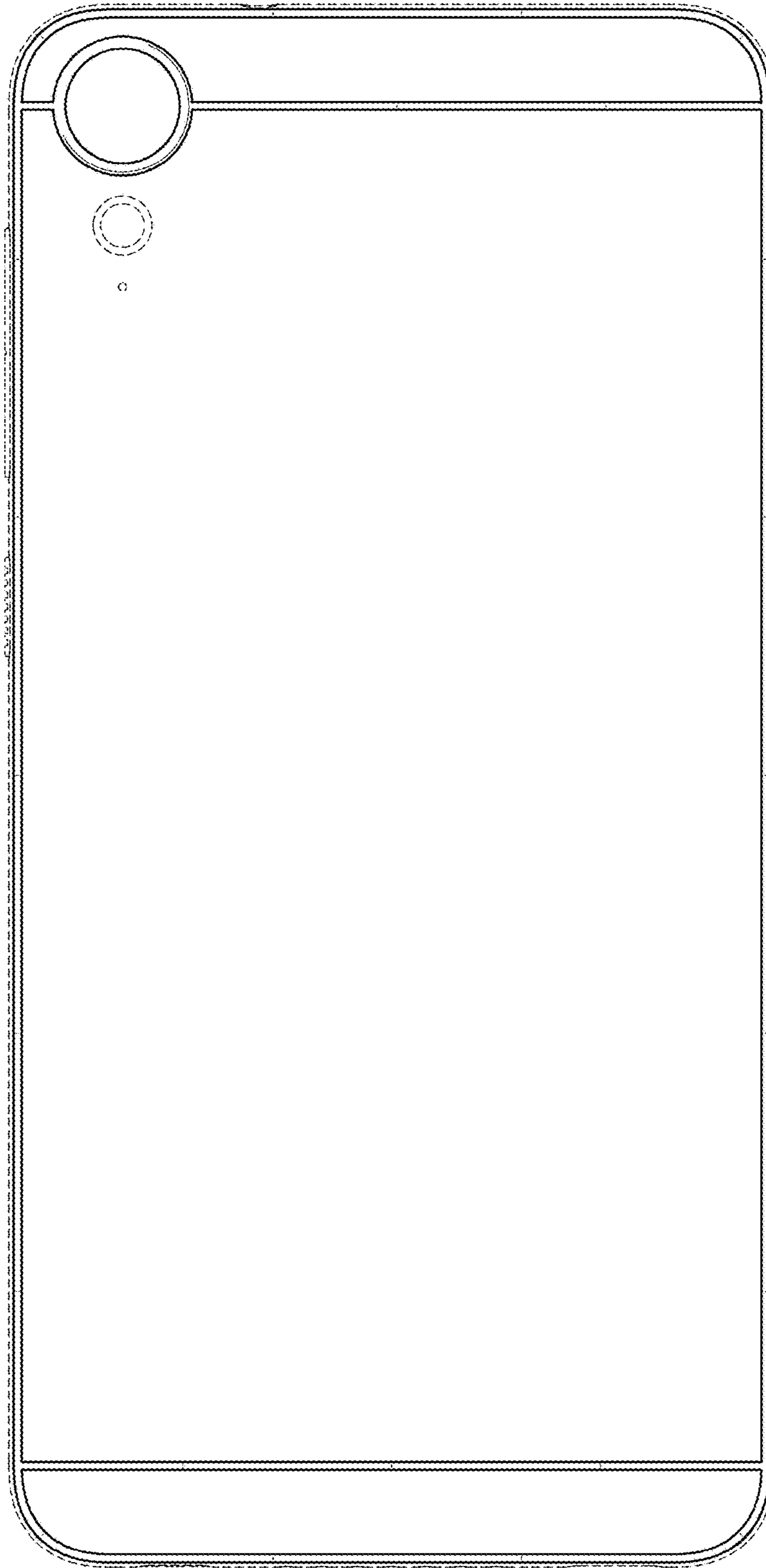

FIG. 12



FIG. 13

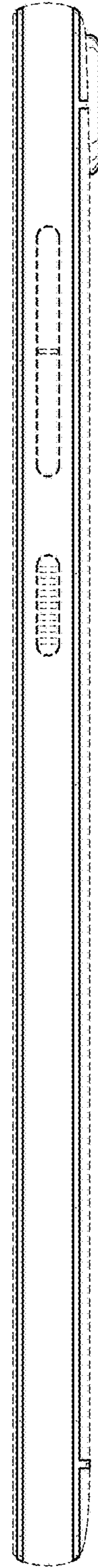

FIG. 14



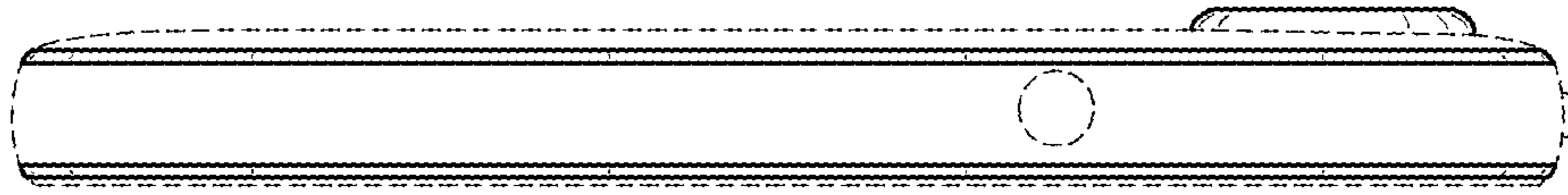

FIG. 15

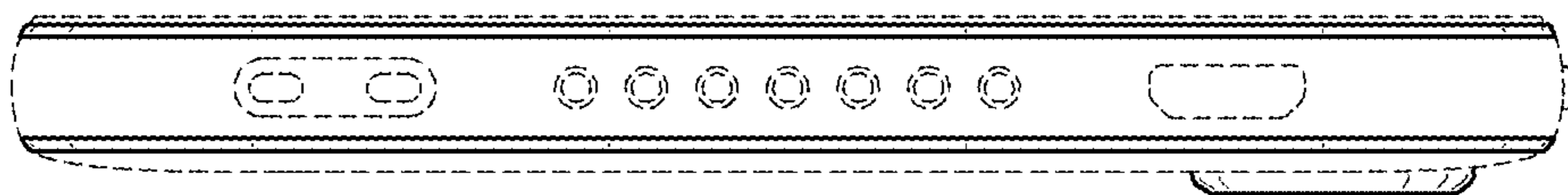

FIG. 16