



US00D810614S

(12) **United States Design Patent**
Sodt et al.

(10) **Patent No.:** **US D810,614 S**

(45) **Date of Patent:** **** Feb. 20, 2018**

(54) **TOMBSTONE**

(71) Applicant: **TARGET BRANDS, INC.**,
Minneapolis, MN (US)

(72) Inventors: **Christopher Sodt**, Plymouth, MN
(US); **Anna Bofinger**, Shoreview, MN
(US)

(73) Assignee: **TARGET BRANDS, INC.**,
Minneapolis, MN (US)

(**) Term: **15 Years**

(21) Appl. No.: **29/574,525**

(22) Filed: **Aug. 16, 2016**

(51) **LOC (11) Cl.** **11-04**

(52) **U.S. Cl.**
USPC **D11/117**

(58) **Field of Classification Search**
USPC D11/31, 49, 82, 100, 117, 134, 158, 173,
D11/224, 233, 232, 239; D99/21–22, 24;
D20/23–24, 30–31; D21/576, 650;
D9/601, 630
CPC E04H 13/00; E04H 13/001; E04H 13/003;
E04H 13/008

See application file for complete search history.

(56) **References Cited**

U.S. PATENT DOCUMENTS

D45,143 S	1/1914	Banks	
D107,648 S *	12/1937	Katz	D11/49
D135,190 S *	3/1943	Philippe	D11/49
D159,638 S *	8/1950	Katz	D11/49
D223,118 S *	3/1972	Feuer	D1/107
D272,894 S *	3/1984	Kodaka	D11/158
D296,456 S	6/1988	Guidry	
D333,443 S *	2/1993	Shyan	D10/116.1
D378,361 S	3/1997	Shaw et al.	

D388,359 S	12/1997	Shaw	
D417,638 S	12/1999	Pierson, Sr.	
D457,648 S	5/2002	Chang	
D464,093 S *	10/2002	Weiser	D21/585
D629,471 S *	12/2010	O'Keefe	D21/650
D642,229 S *	7/2011	Shapiro	D21/650
D721,956 S *	2/2015	Katopo	D9/630
2008/0193452 A1 *	8/2008	Meinwald	C07H 19/06 424/137.1

OTHER PUBLICATIONS

Halloween Premium Spider Tombstone—Hyde and Eek! Boutique™, posted at Target.com, posted on © 2017, site visited Nov. 1, 2017, <<https://www.target.com/p/halloween-premium-spider-tombstone-hyde-and-eek-boutique-153/-/A-52305905>>.*

(Continued)

Primary Examiner — Barbara Fox

Assistant Examiner — Messina L Smith

(74) *Attorney, Agent, or Firm* — JoAnn M. Seaton;
Griffiths & Seaton PLLC

(57) **CLAIM**

The ornamental design for a tombstone, as shown and described.

DESCRIPTION

FIG. 1 is a front perspective view of a tombstone showing our new design;

FIG. 2 is a front view thereof;

FIG. 3 is a rear view thereof;

FIG. 4 is a right side view thereof;

FIG. 5 is a left side view thereof;

FIG. 6 is a top view thereof; and,

FIG. 7 is a bottom view thereof.

The broken lines in the drawings depict portions of the tombstone that form no part of the claimed design.

1 Claim, 5 Drawing Sheets

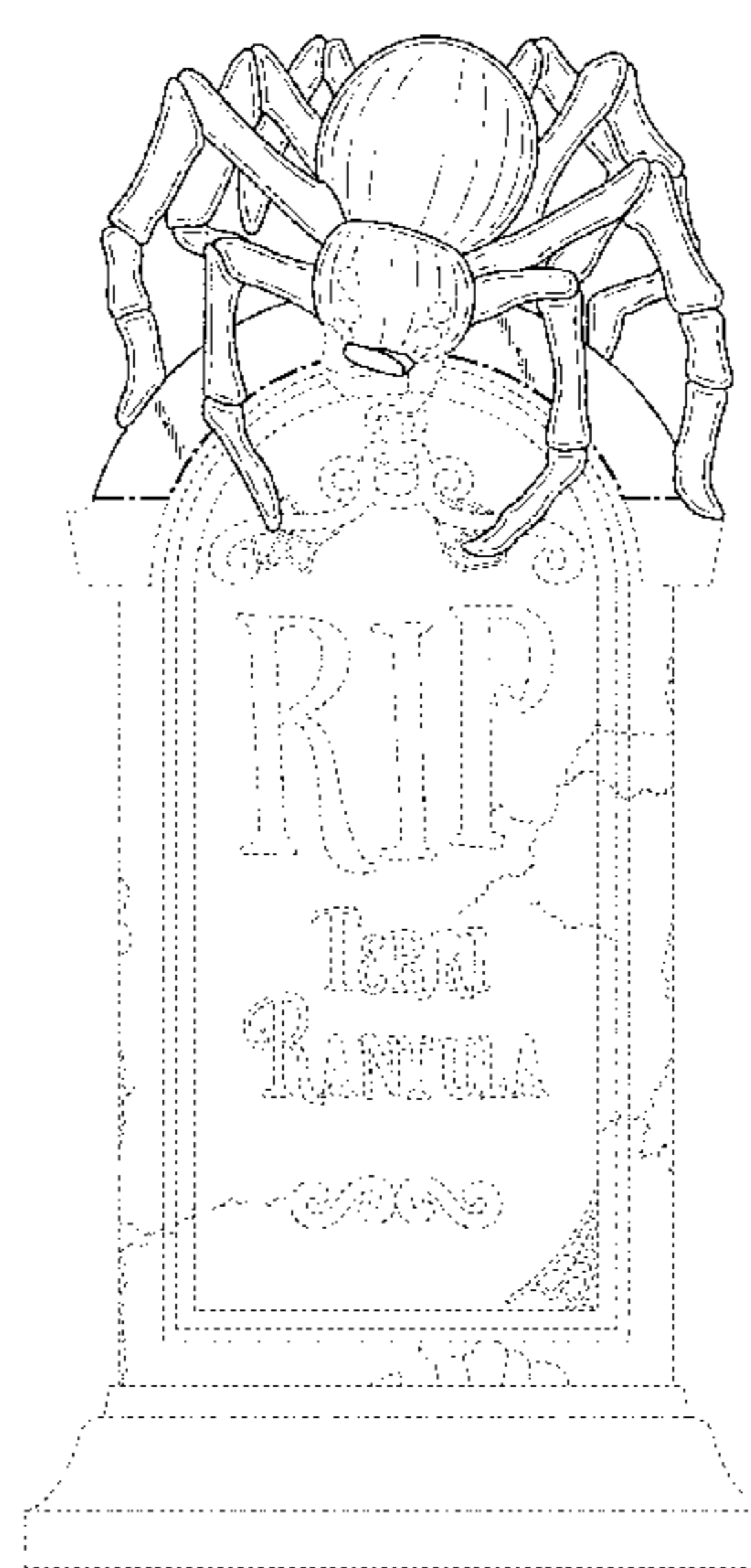
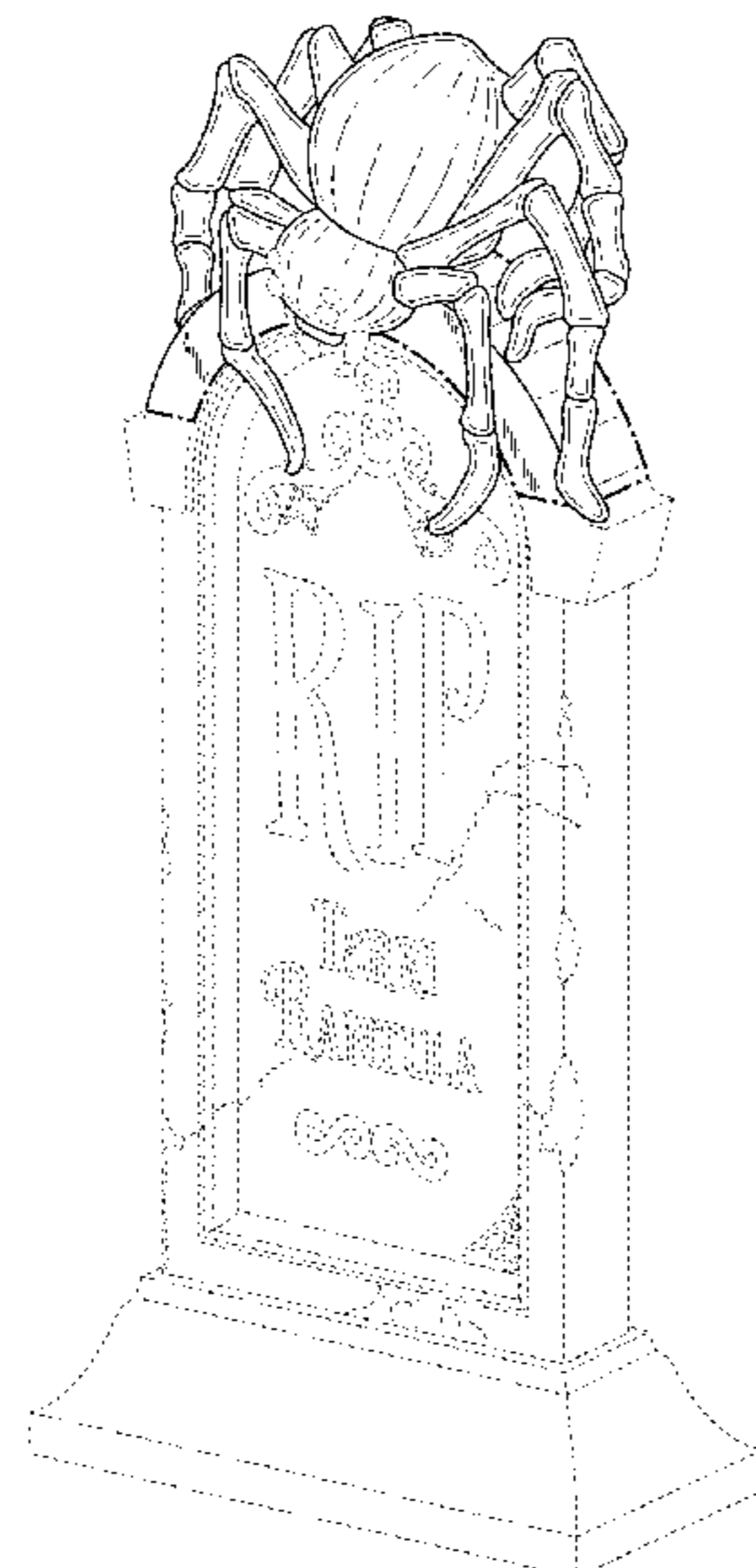

(56)

References Cited

OTHER PUBLICATIONS

Halloween Decorations: “Giant Spider with LED Eyes and Timer Function” from Costco, posted at Youtube.com, posted on Oct. 15, 2015, site visited Nov. 1, 2017, <<https://www.youtube.com/watch?v=FyWTLNDqCic>>.*

Assorted Spooks III, posted at Bogleech.com, posted on Oct. 31, 2016, site visited Nov. 1, 2017, <<http://www.bogleech.com/halloween/hall16-misc3.html#comment-2957681487>>.*

“22 Inch Jacobs Tombstone”, printed from www.spirithalloween.com/catalog/search.cmd?form_state=searchForm&keyword=jacobs+tombstone, publicly available at least as early as Jul. 16, 2015 (3 pages).

“Tombstone with Reaper”, printed from www.spirithalloween.com/product/decorations/outdoor-decor/22-inch-led-bone-rip-tombstone/pc/0/c/1005/sc/1020/71134.uts?currentIndex=96&thumbnailIndex=103, publicly available at least as early as Jul. 16, 2015 (5 pages).

“Fake Tombstones—Halloween Yard Decoration”, printed from www.amazon.com/Fake-Tombstones-Halloween-Yard-Decoration/dp/B005V313VQ, publicly available at least as early as Aug. 31, 2012 (6 pages).

Slater, Shawn, “Where the Tombstones Quake”, printed from <http://disneyshawn.blogspot.com/2009/10/where-crypt-doors-creak-and-tombstones.html>, posted in Oct. 2009 (10 pages).

“D0121 Halloween Decorations”, printed from www.aliexpress.com/item/D0121-Halloween-Halloween-decoratio...or-props-Halloween-addresses-tombstone-props-5pcs/2041296400.html, publicly available at least as early as Aug. 4, 2015 (5 pages).

“Polyfoam Tombstone”, printed from www.alibaba.com/product-detail/Halloween-decoration-38CM-s...-cheap-Polyfoam_1979146441.html?spm=a2700.7724857.35.1.fLJ4Ma&s=p, publicly available at least as early as Aug. 8, 2015 (7 pages).

“Halloween Decorations: Your Guide to Decorating for Halloween”, printed from www.halloweendecorations101.com/halloween-decorations-graveyard.html, publicly available at least as early as Jul. 17, 2015 (3 pages).

“Halloween Props Bar Decoration Voice-Activated Light Emitting Tombstone”, printed from www.aliexpress.com/item/Halloween-props-bar-decoration-voice-activated-light-emitting-tombstone/1348942577.html, publicly available at least as early as Aug. 4, 2015 (3 pages).

Washburn, Bill, “Step-By-Step Instructions to Make Halloween Gravestones”, printed from www.idealhomegarden.com/holidays-crafts/instructions-make-halloween-gravestones/, posted on Aug. 31, 2012 (5 pages).

“RIP Skull Spider Tombstone”, printed from <http://ghoulskout.deviantart.com/art/RIP-skull-spider-tombstone-131414102>, publicly available Jul. 29, 2009 (2 pages).

“Tombstone by Sugar Delites”, printed from www.sugardelites.com/Tombstone-By-Sugar-Delites_p_1432.html, publicly available at least as early as Aug. 4, 2015 (2 pages).

Beaulieu, David, “Tombstone Halloween Decoration with Epitaph”, printed from <http://landscaping.about.com/od/landscapecolor/ig/Scary-Halloween-Pictures/Tombstone-Halloween-Decoration.htm>, publicly available at least as early as Apr. 3, 2015, per <http://web.archive.org> (4 pages).

“Tombstone-RIP”, printed from www.statsfloral.com/halloween-2011-tombstones-91716-rip.htm, publicly available at least as early as 2013 (1 page).

“Halloween Tombstones”, printed from www.halloweencostumes.com/tombstones.html, publicly available at least as early as Aug. 4, 2015 (4 pages).

Photograph of Public Gravestone, (1 page).

“Joseph Palmer—Find a Grave Photos”, printed from www.findagrave.com/cgi-bin/fg.cgi?page=pv&GRid=44843658&Pipi=54135499, posted on Jan. 10, 2012 (3 pages).

Tombstone Image, printed from https://encrypted-tbn0.gstatic.com/images?q=tbn:ANd9GcQGbCvgLSGZ_hlx0zwJm8pHIqM4TbRBhYh7a2cefCJkqhutmzxk, publicly available at least as early as Jul. 13, 2015 (1 page).

“Documenting the Details: Sep. 2010”, printed from http://lfmccauley.blogspot.com/2010_09_01_archive.html, publicly available at least as early as Sep. 1, 2010 (18 pages).

“15 Inch Spider Tombstone Table Piece Halloween Decoration”, printed from www.walmart.com/ip/15-Spider-Tombstone-Table-Piece-Halloween-Decoration/44680750, publicly available at least as early as May 27, 2016 (4 pages).

U.S. Appl. No. 29/538,438, filed Sep. 3, 2015 (19 pages).

“Dollar Tree Tombstone Make-Over”, printed from www.halloween.com/forums/viewtopic.php?t=8236, posted on Aug. 20, 2011 (13 pages).

“Lighted 21 Inch Tombstone Spider Graveyard Halloween Party Prop”, printed from www.ebay.com/itm/Lighted-21-Tombstone-Spider-Graveyard-Ha...-Decoration-/381647516981?hash=item58dbf6f535:g:qbwAAOxyiBpSKk6i, publicly available at least as early as May 27, 2016 (3 pages).

“RIP Spider & Skulls Tombstones Headstones with Spider Web Halloween Decor Bundle”, printed from www.terapeak.com/worth/rip-spider-skulls-tombstones-headstones-w-spider-web-halloween-decor-bundle/231710594556/, publicly available at least as early as May 27, 2016 (4 pages).

“Spider Tombstone”, printed from www.halloweenforum.com/halloween-props/142562-spider-tombstone.html, posted on Jul. 31, 2015 (5 pages).

* cited by examiner

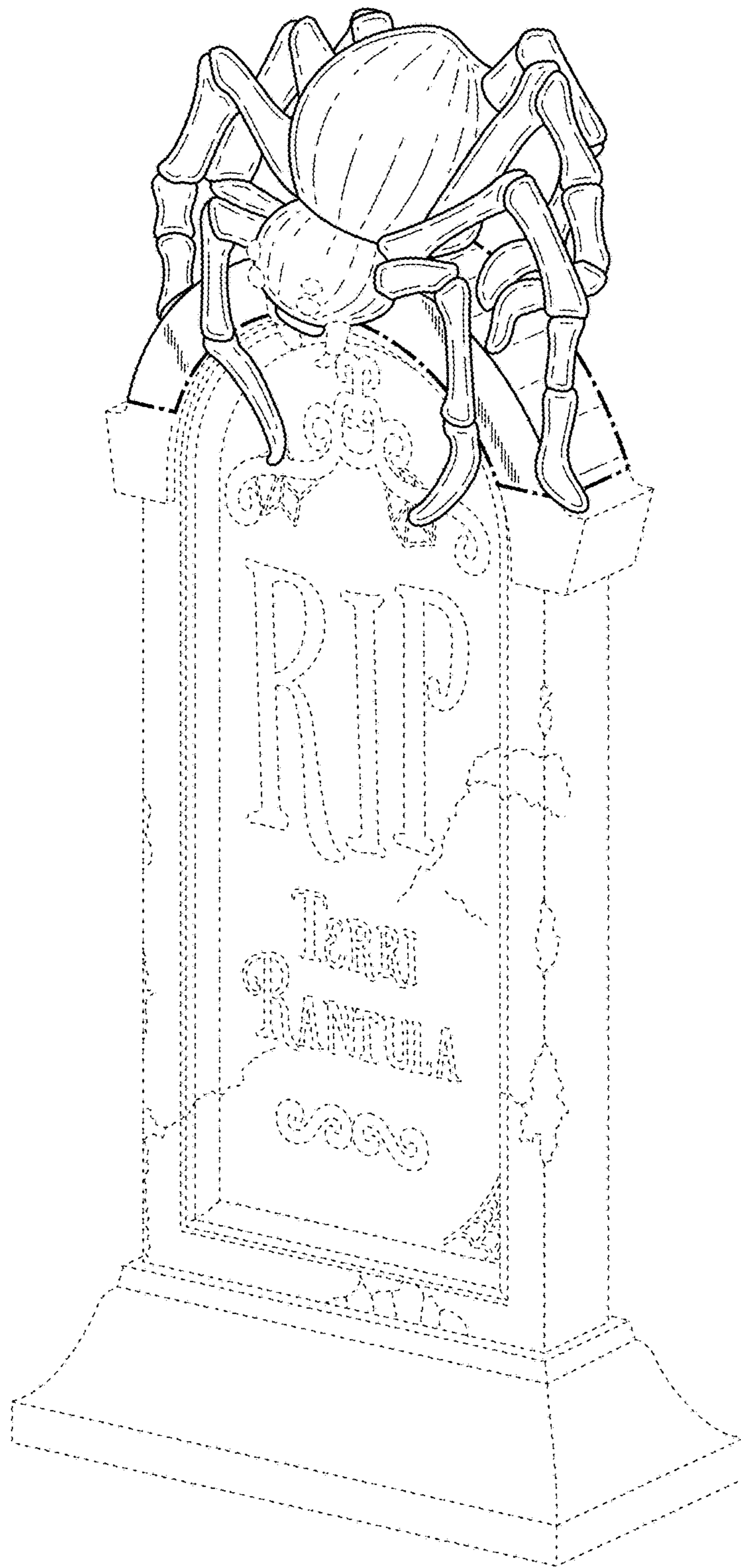

FIG. 1

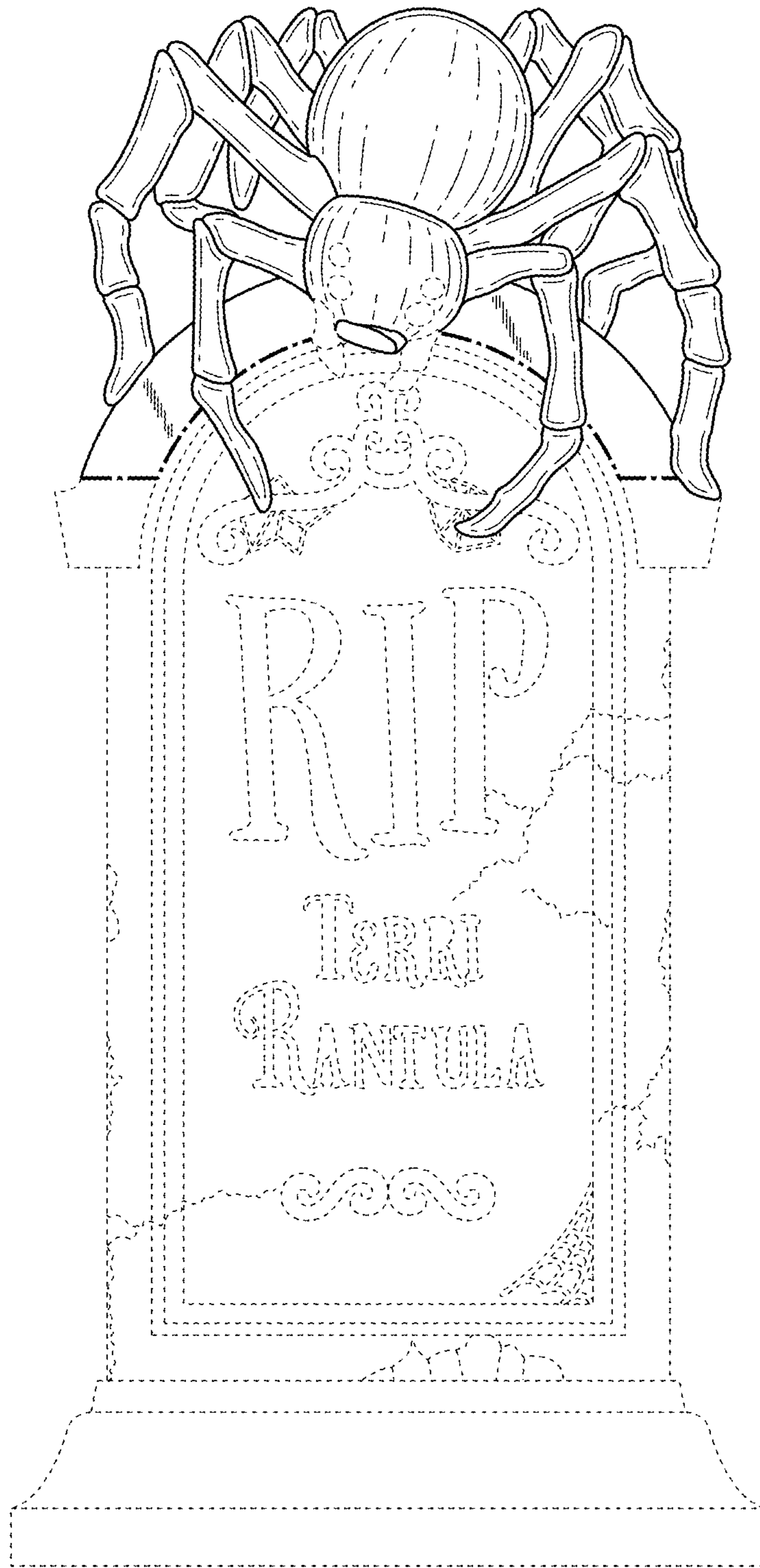

FIG. 2

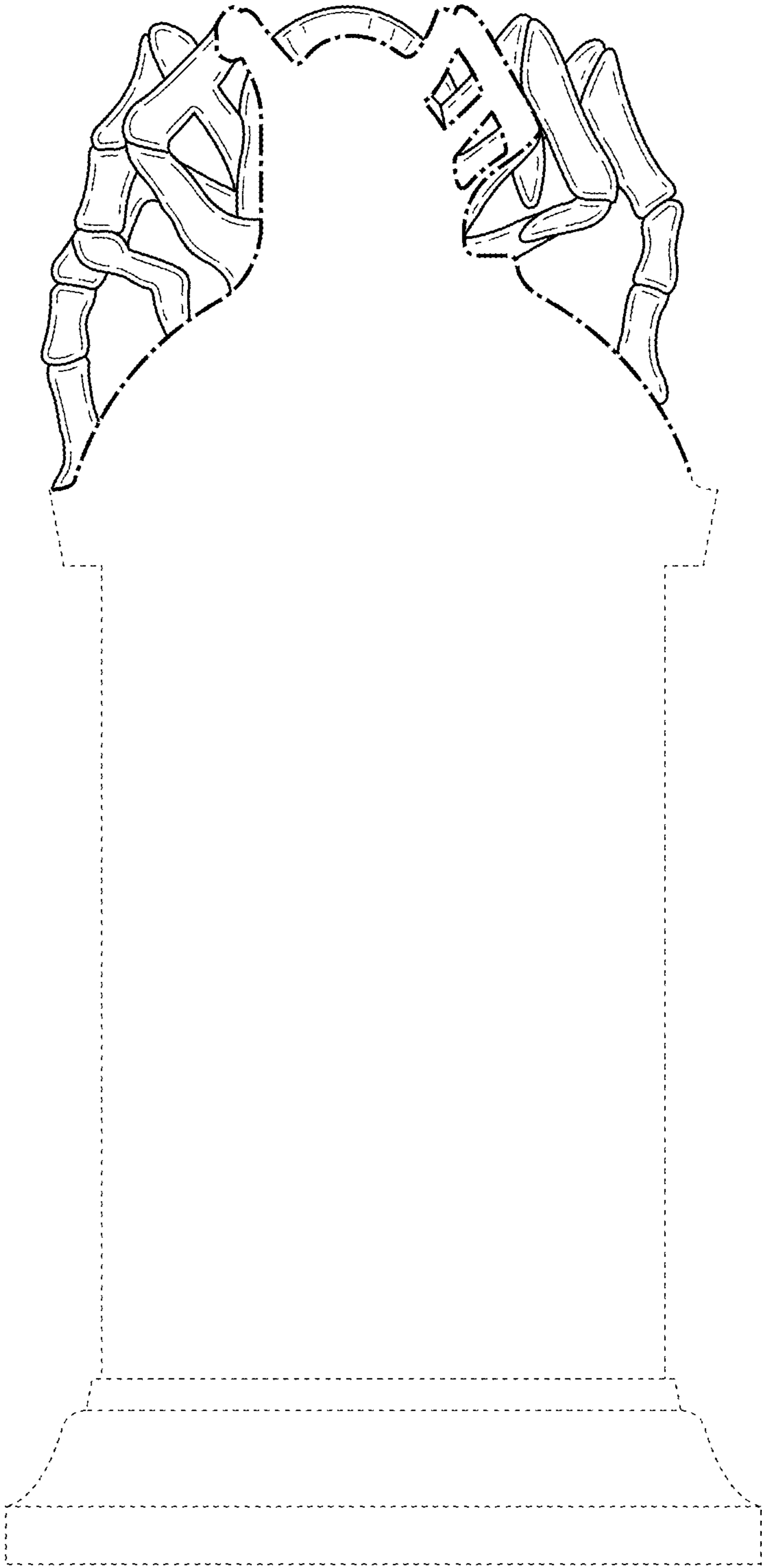

FIG. 3

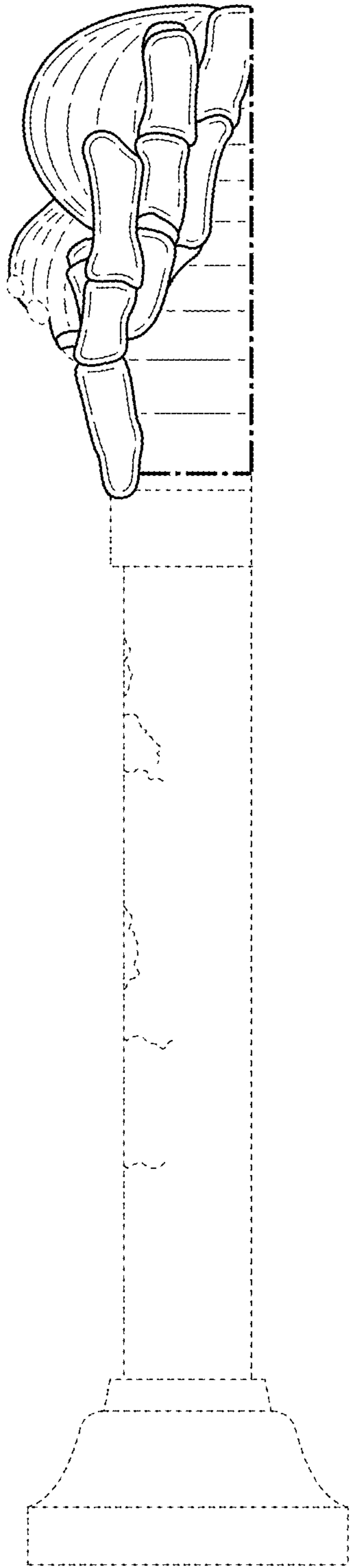

FIG. 4

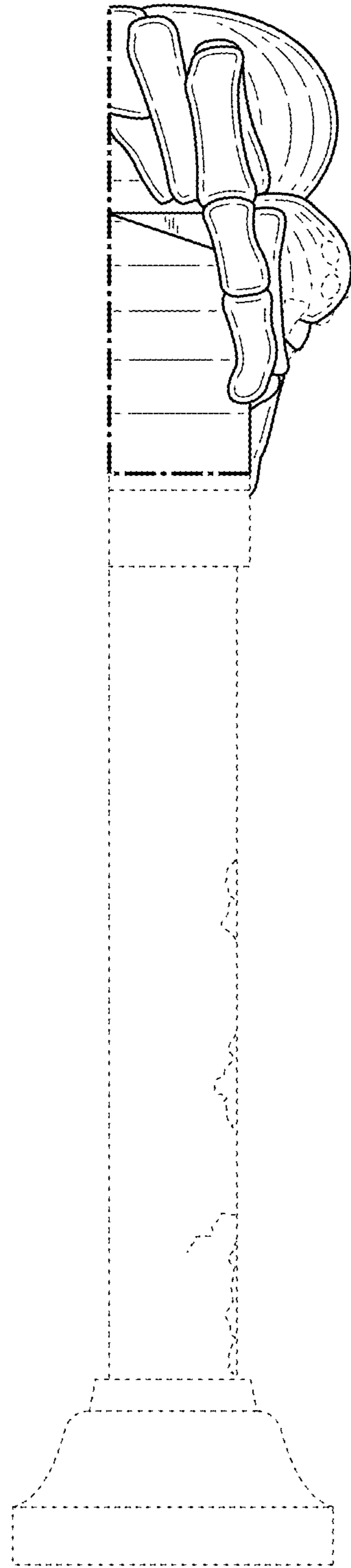

FIG. 5

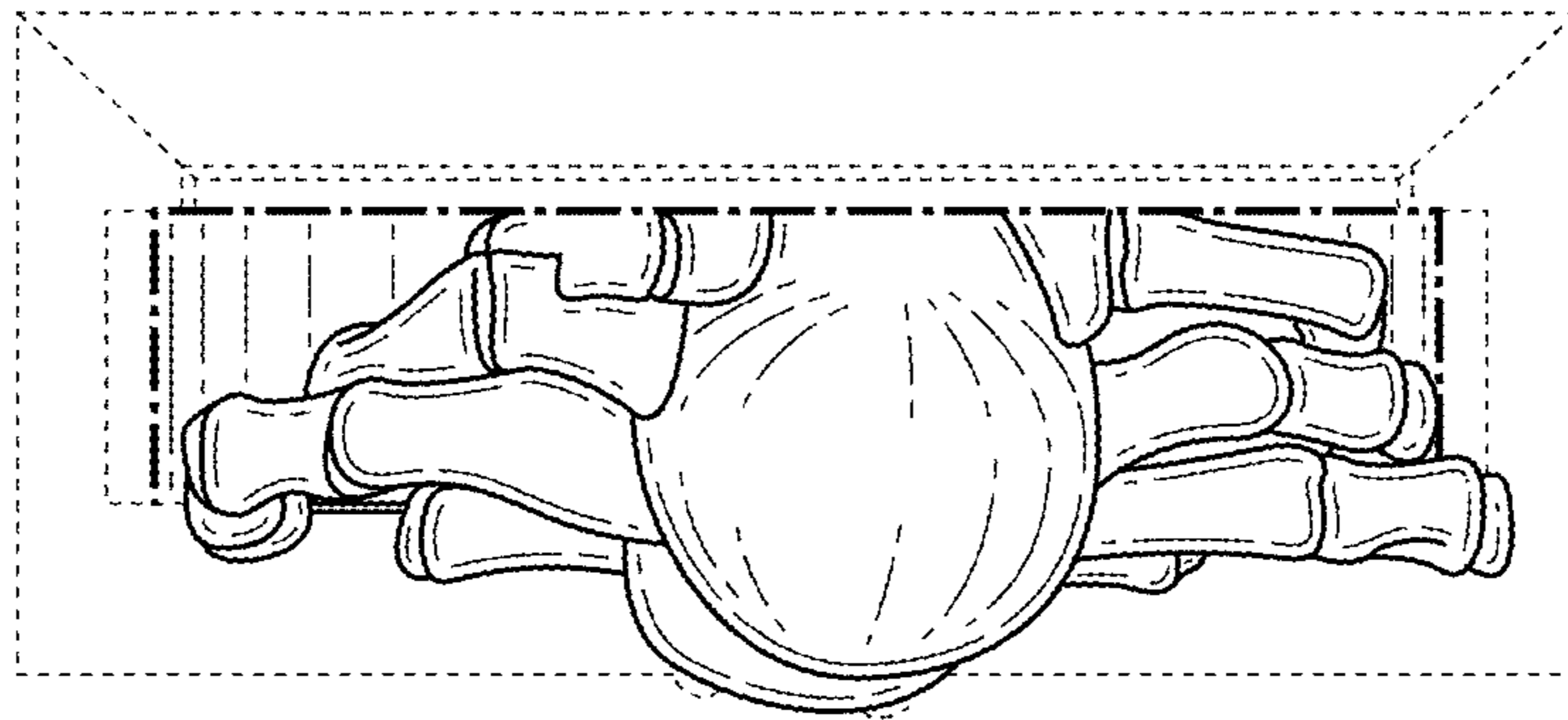

FIG. 6

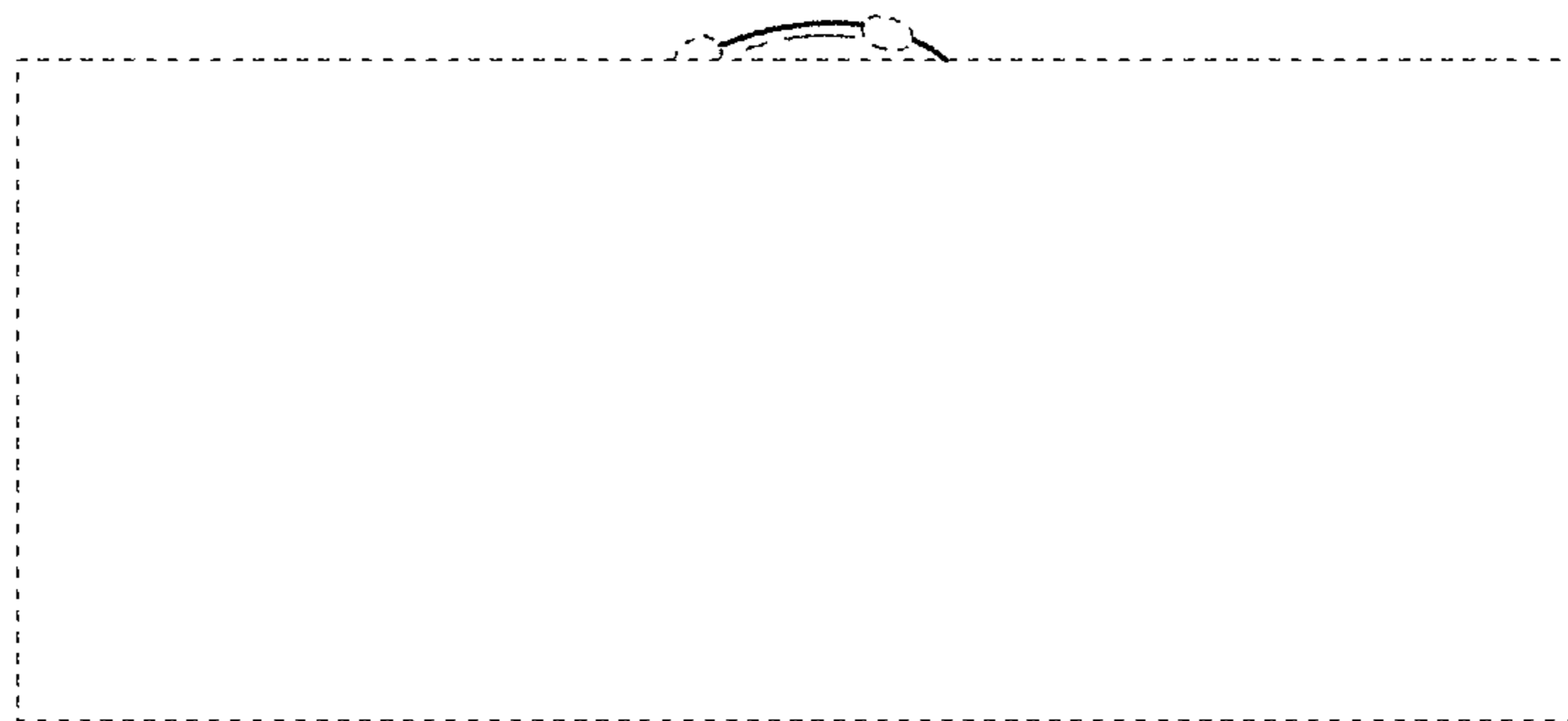

FIG. 7