



US00D810540S

(12) **United States Design Patent**
Marfione

(10) **Patent No.:** **US D810,540 S**

(45) **Date of Patent:** **** Feb. 20, 2018**

(54) **SWITCHBLADE**

8,671,578 B1 3/2014 Frazer
D765,217 S * 8/2016 Tom D22/118
9,573,282 B1 2/2017 Sheahan

(71) Applicant: **Microtech Knives**, Bradford, PA (US)

(72) Inventor: **Anthony Marfione**, Fletcher, NC (US)

(73) Assignee: **Microtech Knives**, Bradford, PA (US)

(**) Term: **15 Years**

(21) Appl. No.: **29/615,905**

(22) Filed: **Aug. 31, 2017**

(51) **LOC (11) Cl.** **08-03**

(52) **U.S. Cl.**
USPC **D8/99**

(58) **Field of Classification Search**
USPC D22/118; D8/95-99; 30/2, 151,
30/158-159, 160-162, 163; D7/649
CPC B26B 1/08
See application file for complete search history.

(56) **References Cited**

U.S. PATENT DOCUMENTS

D265,719 S * 8/1982 Dowdy D8/99
D435,421 S * 12/2000 Strider D8/99
D438,443 S * 3/2001 Keating D8/99
7,305,769 B2 * 12/2007 McHenry B26B 1/08
30/162
D614,933 S * 5/2010 Freeman D8/107
7,797,838 B2 9/2010 Chu
7,979,990 B2 7/2011 Hawk et al.

OTHER PUBLICATIONS

Knifeworks, Benchmade BM46000DLC-1 Phaeton Auto, 3.45" CPM-S30V SS Plain Blade, Anodized Aluminum Handle (Year: 2017).*

KnifeNews, Hogue Extends Automatic Line with New OTF Series, Automatic OTF knife (Year: 2017).*

* cited by examiner

Primary Examiner — Catherine R Oliver-Garcia

(74) *Attorney, Agent, or Firm* — Dority & Manning, P.A.

(57) **CLAIM**

The ornamental design for a switchblade, as shown and described.

DESCRIPTION

FIG. 1 is a perspective view of the switchblade;
FIG. 2 is a front view of the switchblade;
FIG. 3 is a rear view of the switchblade;
FIG. 4 is a left side view of the switchblade;
FIG. 5 is a right side view of the switchblade;
FIG. 6 is a top view of the switchblade; and,
FIG. 7 is a bottom view of the switchblade.
The dotted lines shown in FIGS. 1-7 are environmental only and form no part of the claimed design.

1 Claim, 4 Drawing Sheets

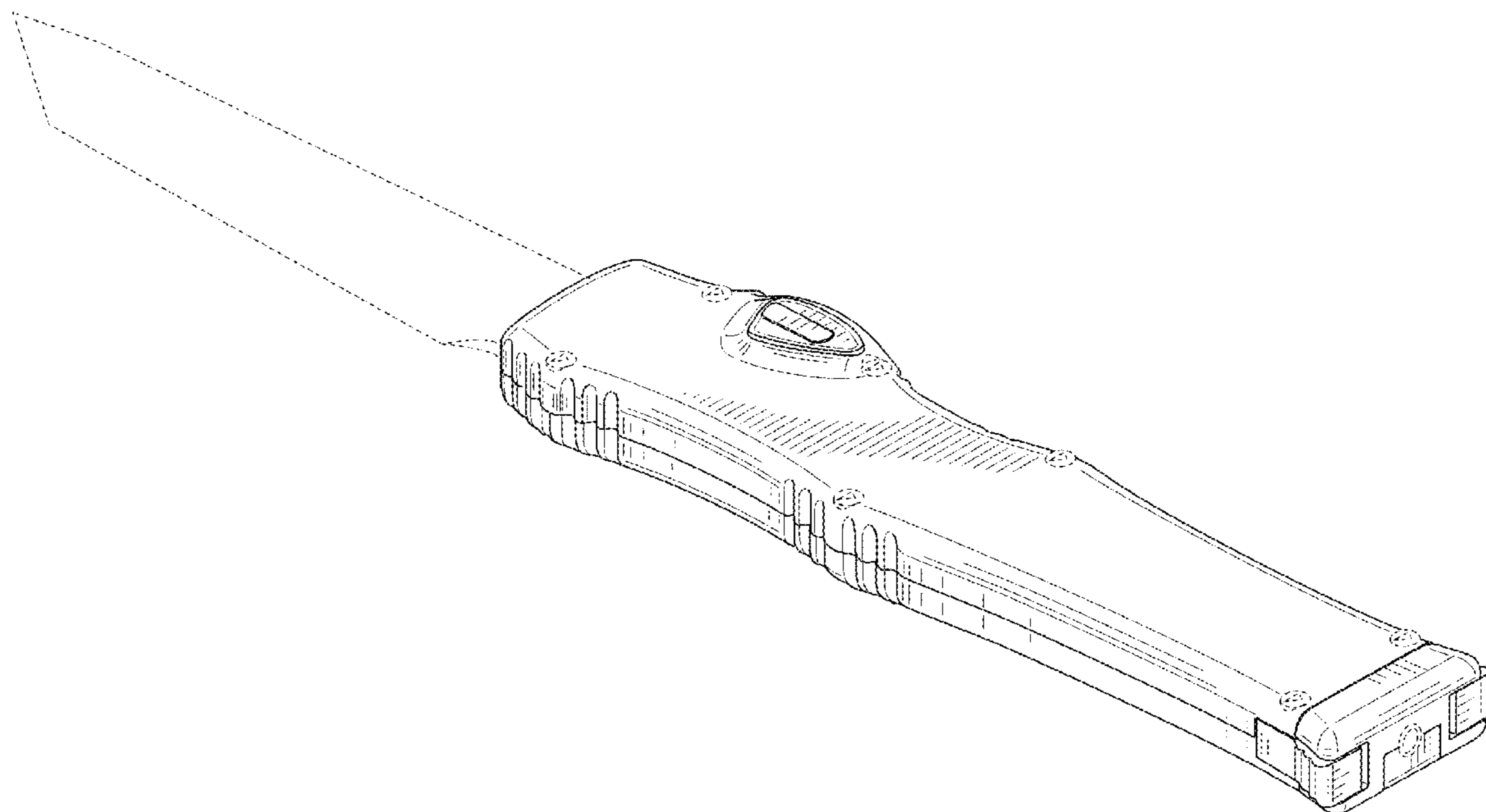

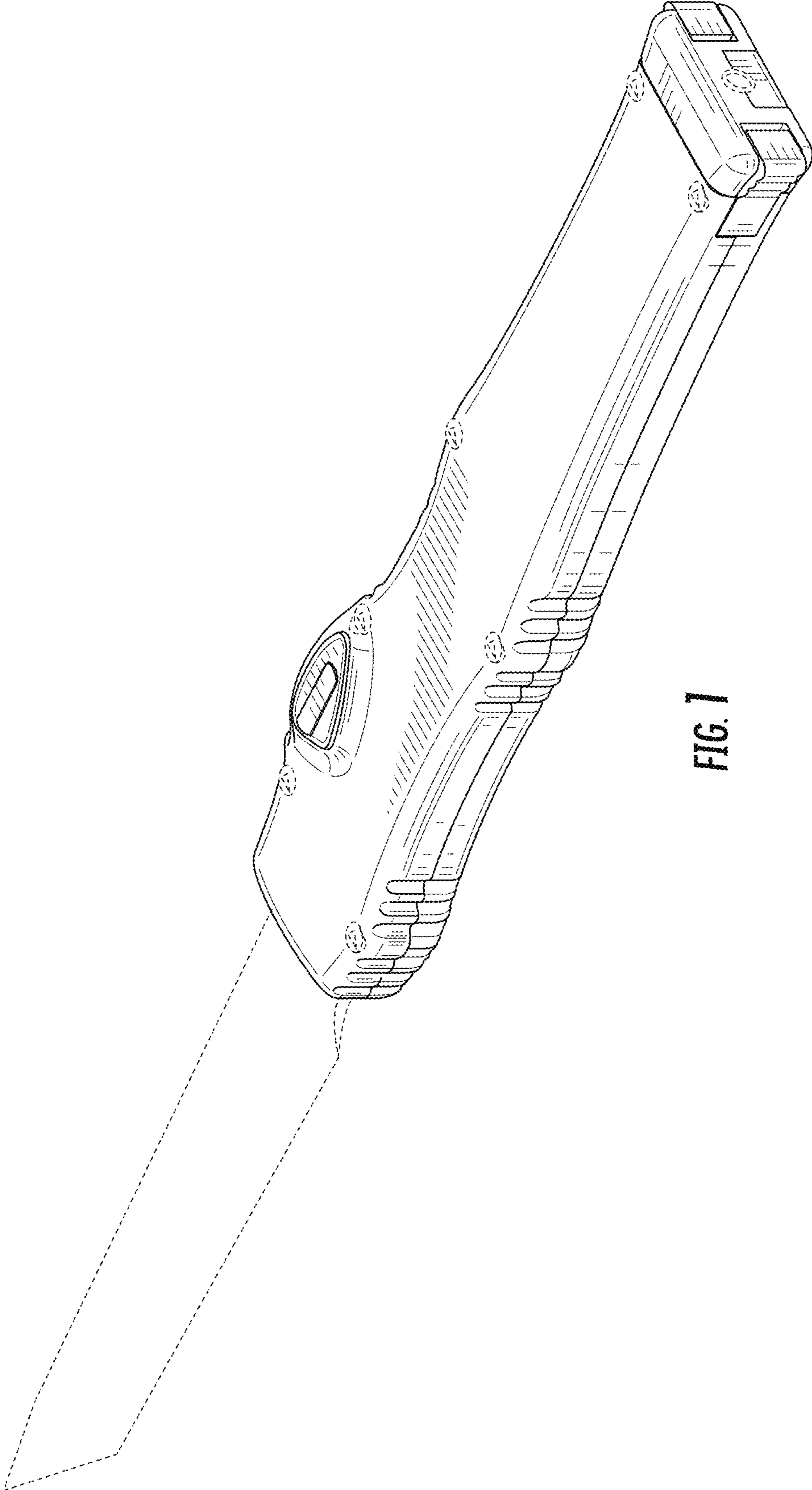

FIG. 1

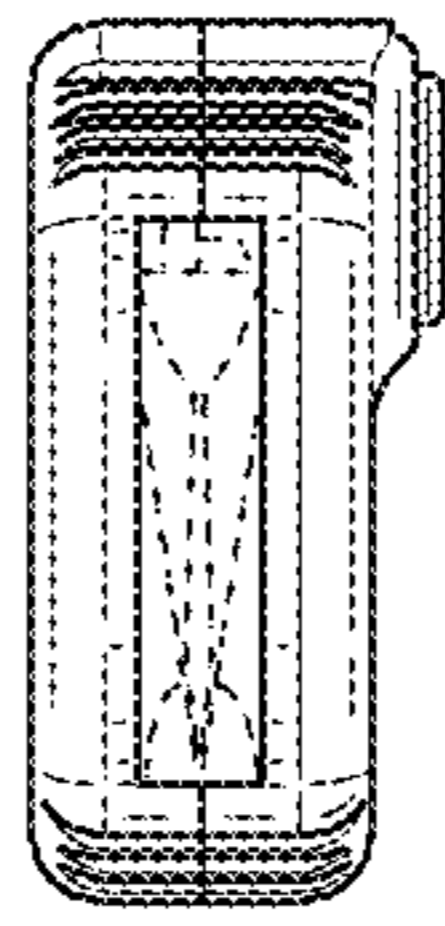

FIG. 2

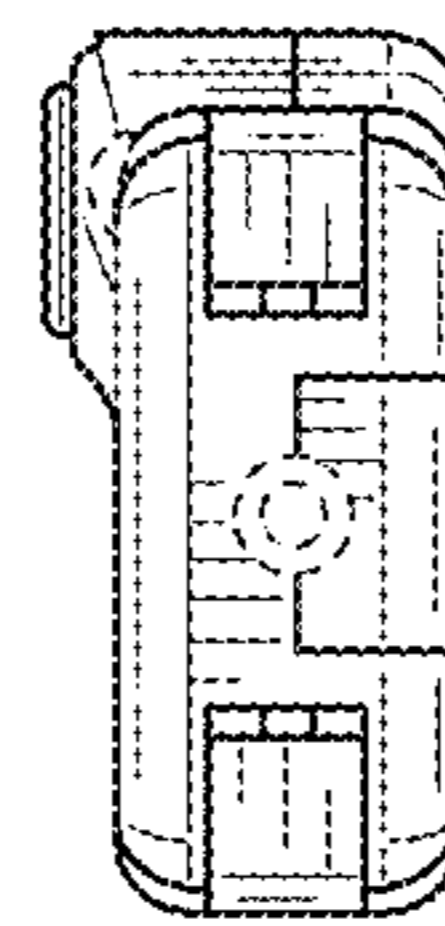

FIG. 3

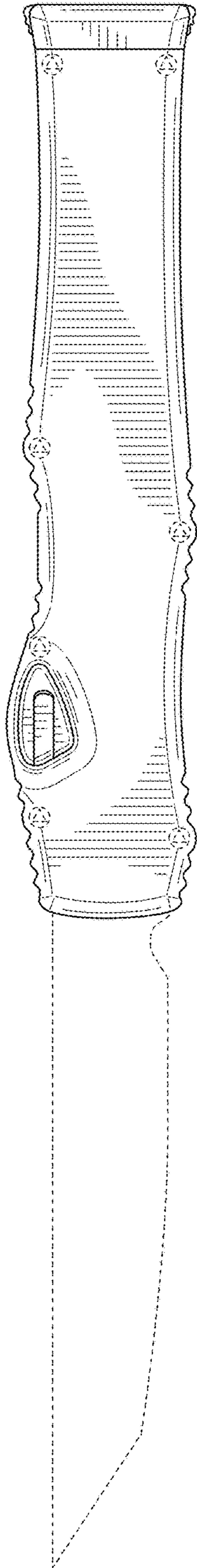

FIG. 4

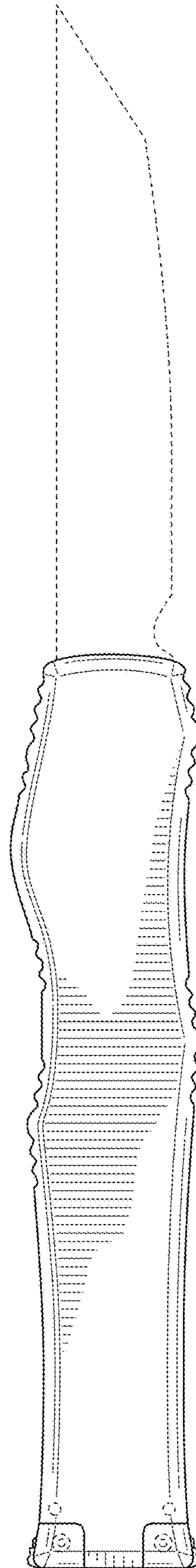

FIG. 5

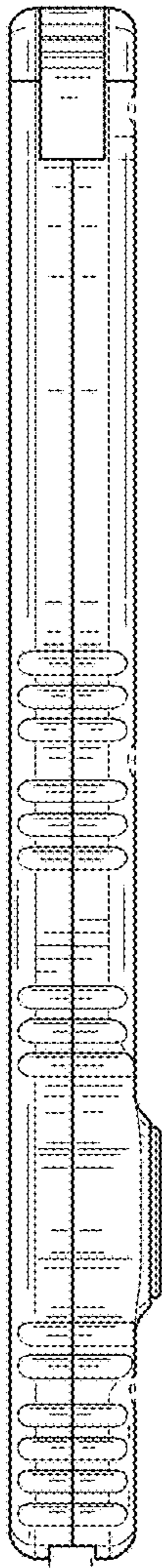

FIG. 6

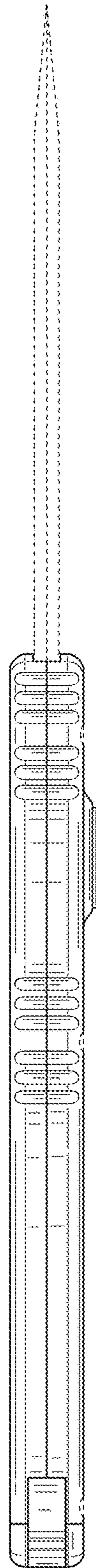

FIG. 7