



US00D810535S

(12) **United States Design Patent**  
**Liu**

(10) **Patent No.:** **US D810,535 S**

(45) **Date of Patent:** **\*\* Feb. 20, 2018**

(54) **PLIER**

(71) Applicant: **Chao-Chih Liu**, Taichung (TW)

(72) Inventor: **Chao-Chih Liu**, Taichung (TW)

(\*\*) Term: **15 Years**

(21) Appl. No.: **29/597,436**

(22) Filed: **Mar. 17, 2017**

(51) **LOC (11) Cl.** ..... **08-03**

(52) **U.S. Cl.**  
USPC ..... **D8/57**

(58) **Field of Classification Search**  
USPC ..... D8/4, 5, 14, 51-582  
CPC ..... B26B 13/12; B26B 13/14; B26B 13/20;  
B26B 13/00; B26B 13/005; B26B 13/06  
See application file for complete search history.

(56) **References Cited**

**U.S. PATENT DOCUMENTS**

D206,588 S \* 1/1967 Rogers ..... D8/5  
D389,714 S \* 1/1998 Snyder ..... D8/57

D442,046 S \* 5/2001 Huang ..... D8/57  
D611,793 S \* 3/2010 Trewartha ..... D8/5  
D650,648 S \* 12/2011 Groten ..... D8/52  
D755,599 S \* 5/2016 Payne ..... D8/57  
D786,039 S \* 5/2017 Roberts ..... D8/57

\* cited by examiner

*Primary Examiner* — Deanna L Pratt

(57) **CLAIM**

The ornamental design for a plier, as shown and described.

**DESCRIPTION**

FIG. 1 is a front-right-top perspective view of the plier showing my new design;  
FIG. 2 is a front elevational view thereof;  
FIG. 3 is a rear front elevational view thereof;  
FIG. 4 is a left side elevational view thereof;  
FIG. 5 is a right side elevational view thereof;  
FIG. 6 is a top plan view thereof;  
FIG. 7 is a bottom plan view thereof; and,  
FIG. 8 is another perspective view thereof.

**1 Claim, 7 Drawing Sheets**

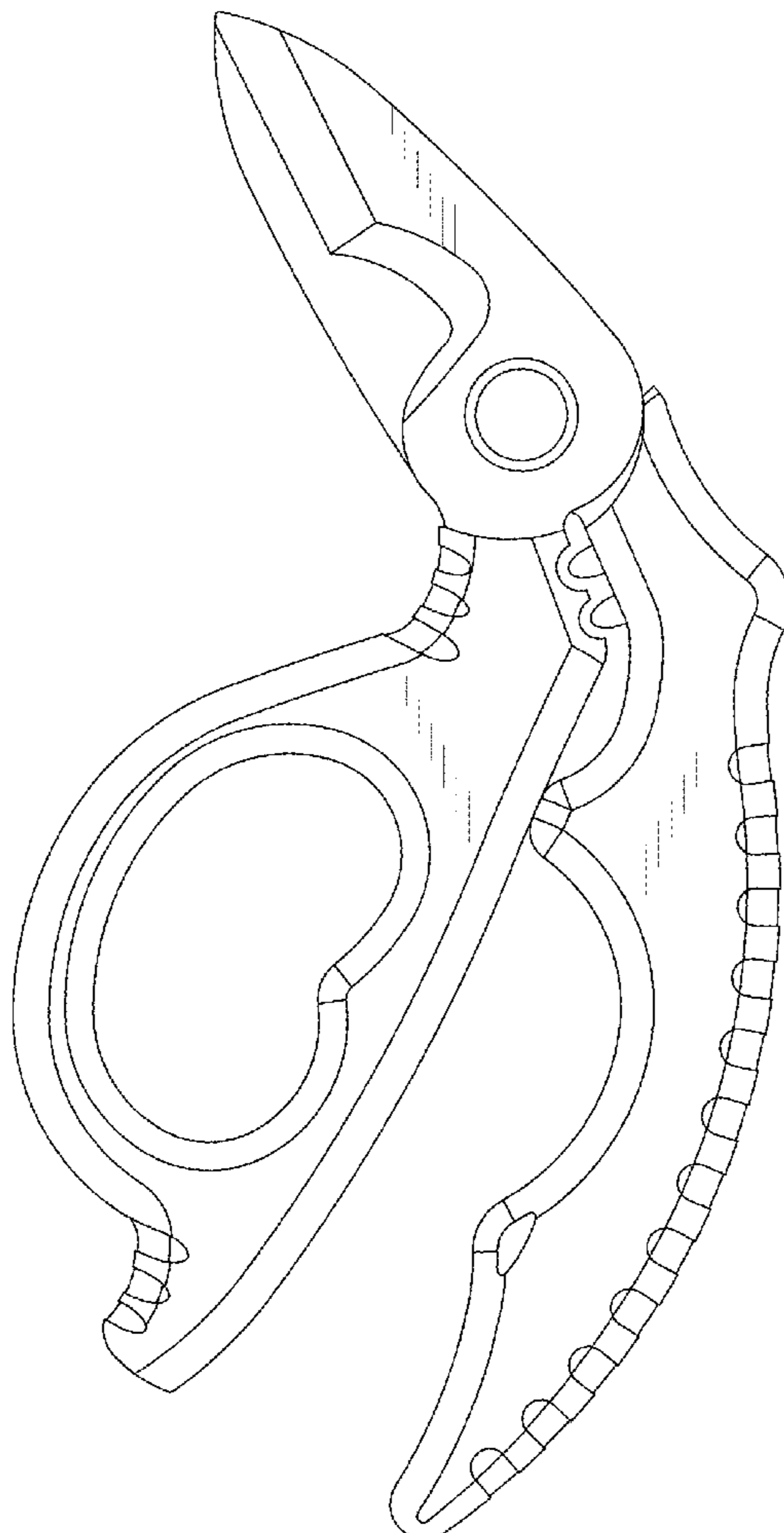

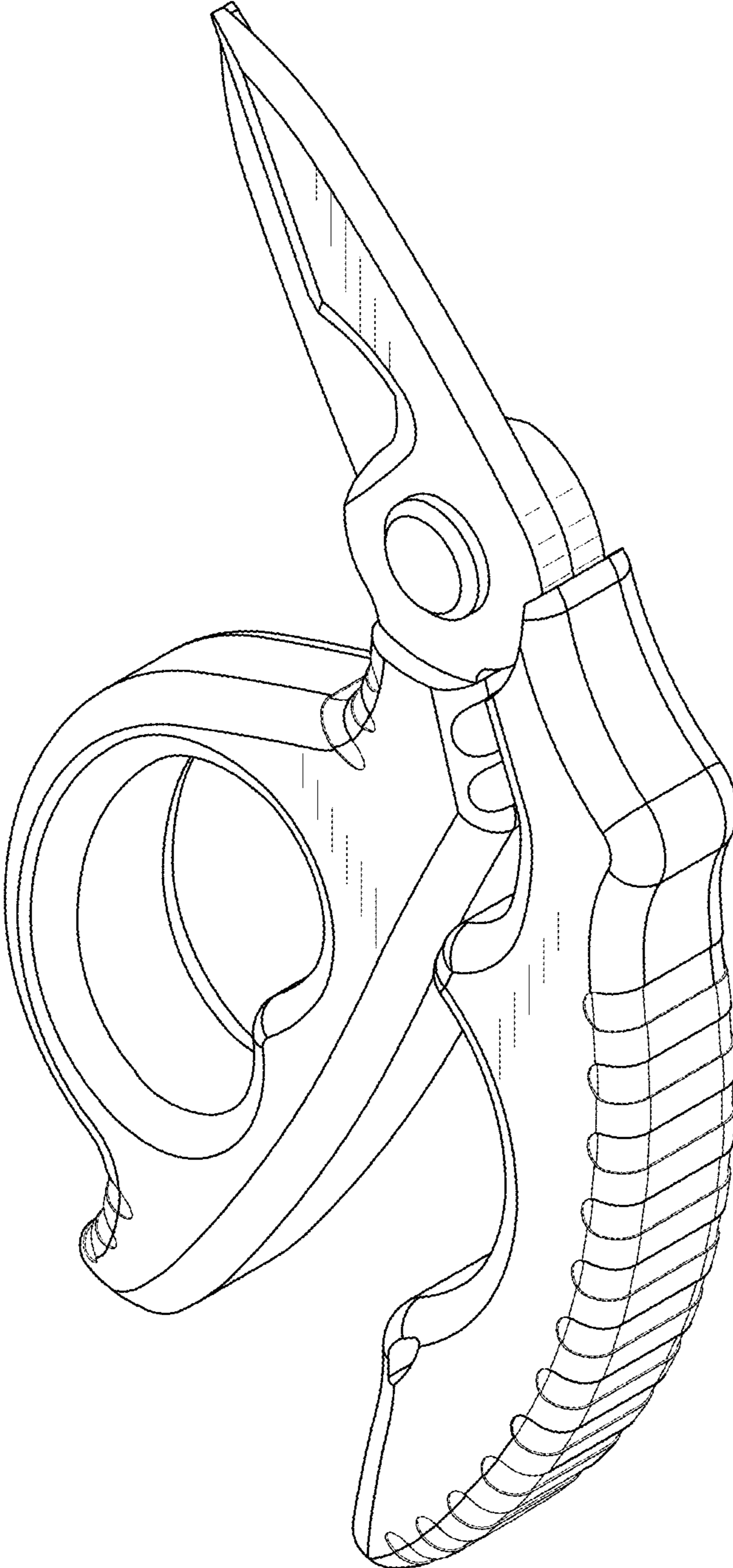

FIG.1

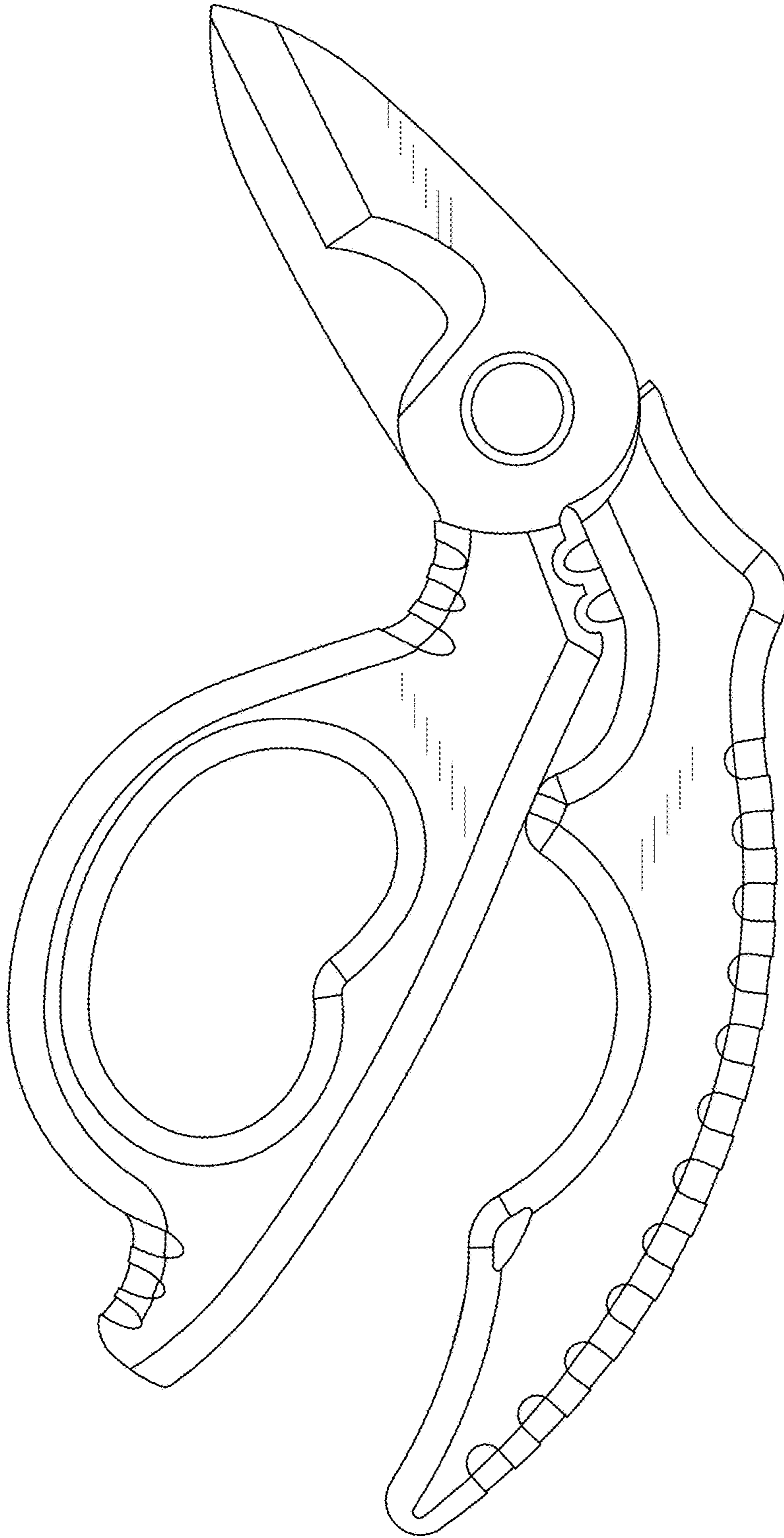

FIG.2

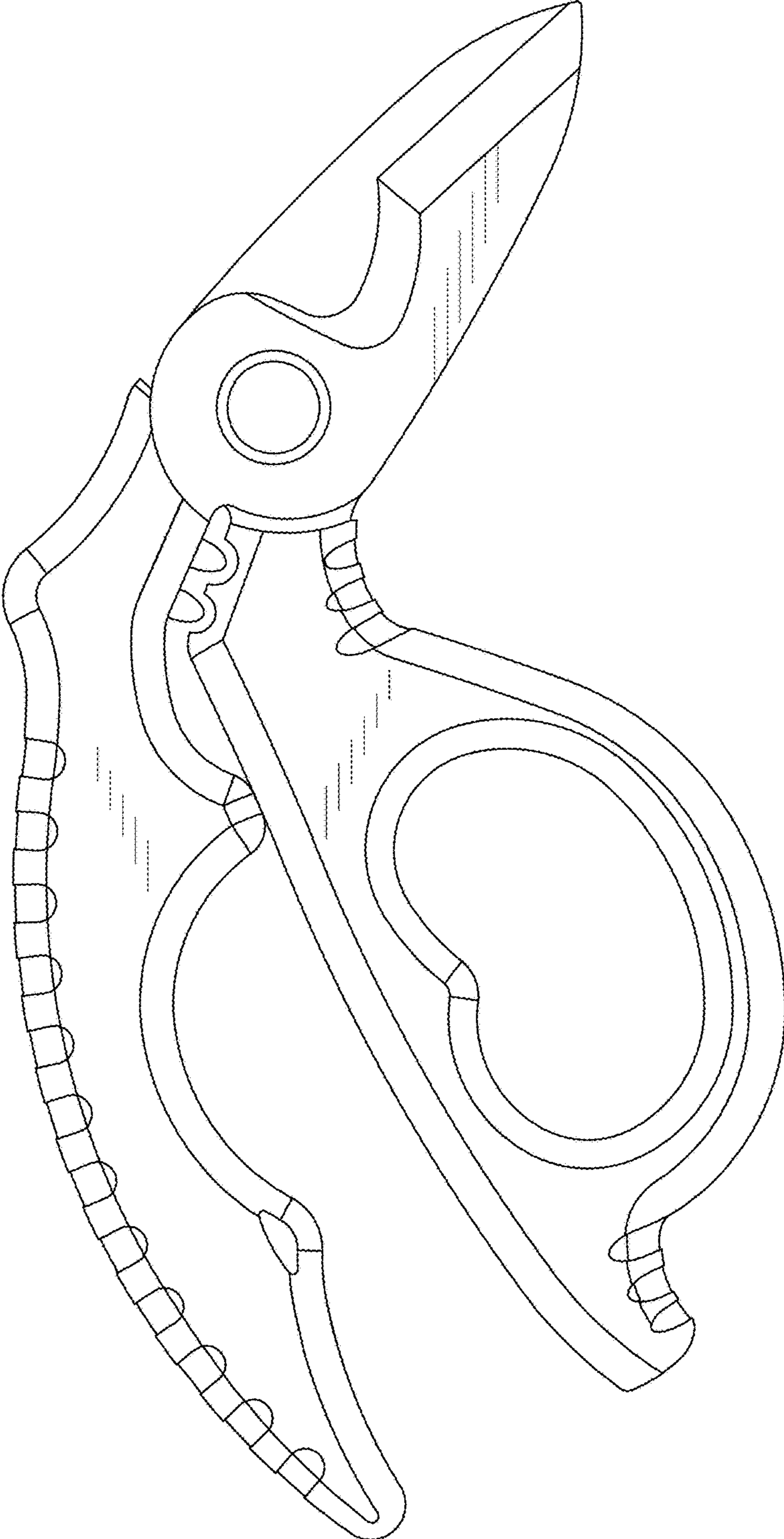

FIG.3

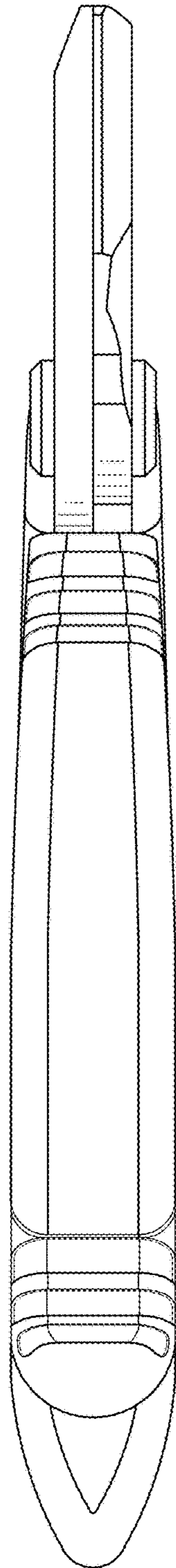

FIG.4

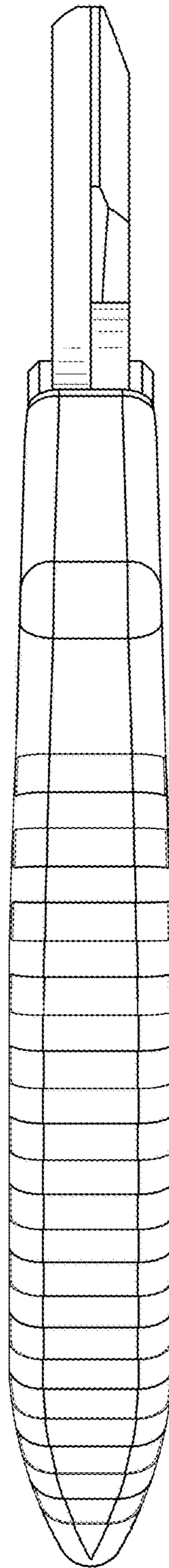

FIG.5

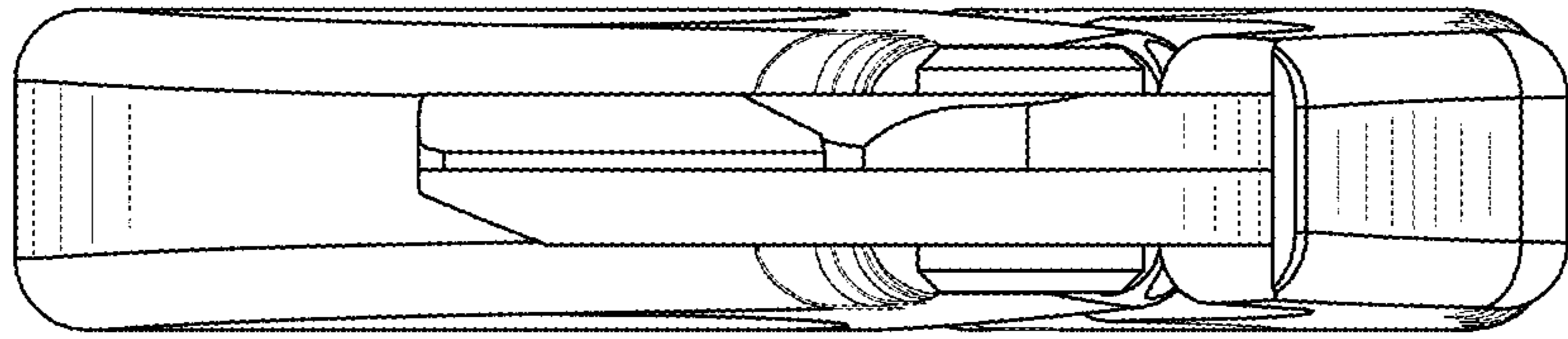

FIG. 6

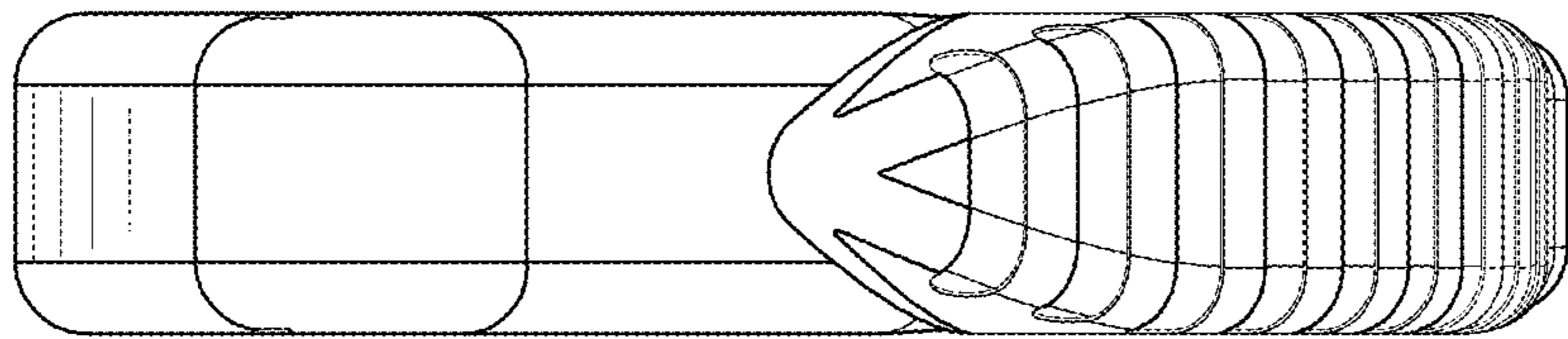

FIG. 7

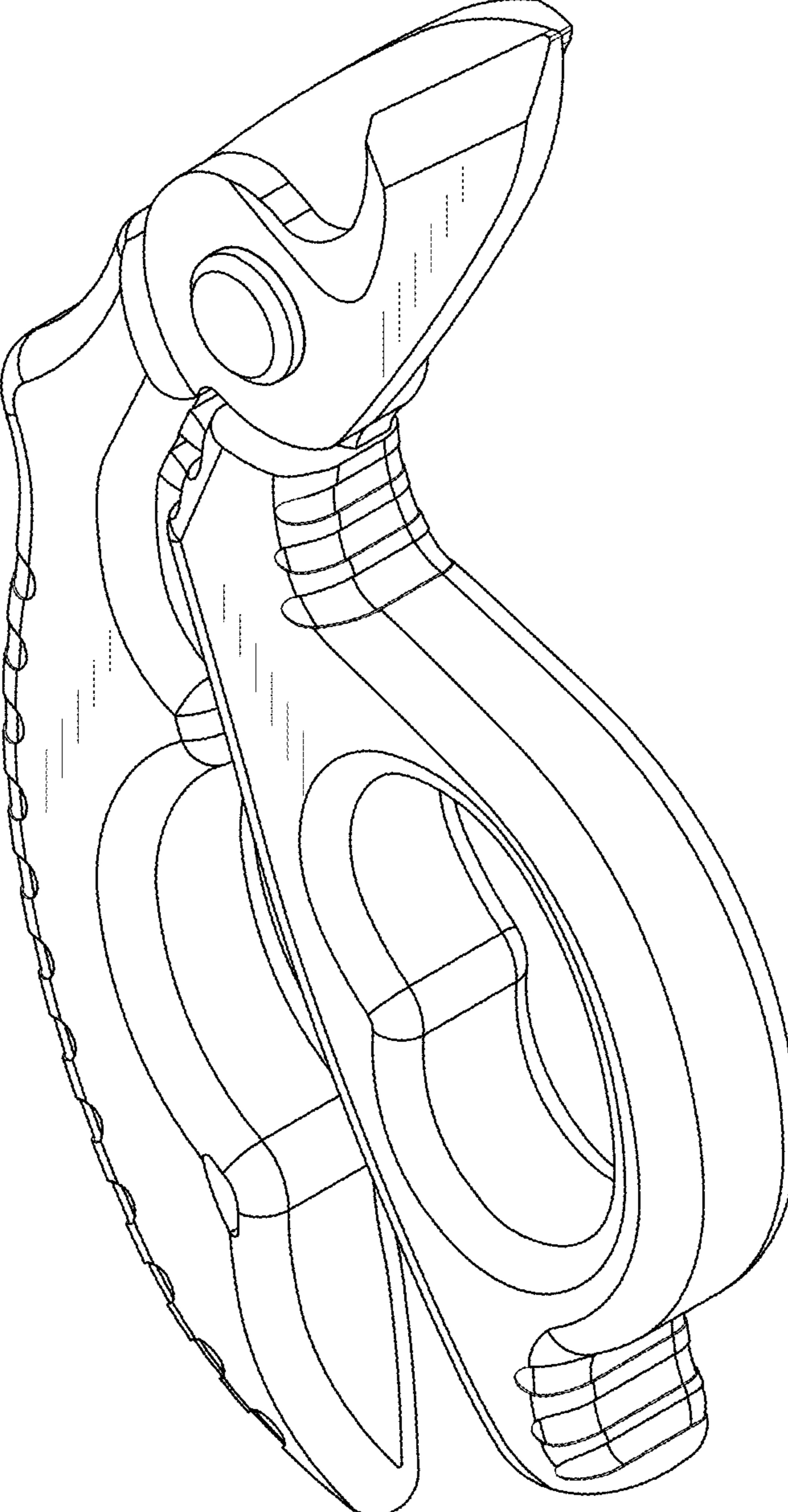

FIG.8