



US00D810517S

(12) **United States Design Patent** (10) **Patent No.:** **US D810,517 S**  
**Singer** (45) **Date of Patent:** **\*\* Feb. 20, 2018**

(54) **KNIFE**  
(71) Applicant: **Norman Singer**, Beit Shemesh (IL)  
(72) Inventor: **Norman Singer**, Beit Shemesh (IL)  
(\*\*) Term: **15 Years**

226,146 A 3/1880 Zimmerer  
235,425 A 12/1880 Gearon  
296,304 A 4/1884 Allen  
369,314 A 9/1887 Brougher  
391,268 A 10/1888 Parker  
490,577 A 1/1893 Memminger  
(Continued)

(21) Appl. No.: **29/603,642**  
(22) Filed: **May 11, 2017**

**FOREIGN PATENT DOCUMENTS**

CN 2052708 U 2/1990  
CN 201573219 U 9/2010  
(Continued)

**Related U.S. Application Data**

(62) Division of application No. 29/548,728, filed on Dec. 16, 2015, now Pat. No. Des. 795,639.

(51) **LOC (11) Cl.** ..... **07-03**  
(52) **U.S. Cl.**  
USPC ..... **D7/649**

(58) **Field of Classification Search**  
USPC ..... D7/393-395, 401.2, 642-652, 673,  
D7/682-683, 693, 695-696; D8/93,  
D8/97-100, 107, 300, 321; D22/117-118  
CPC ..... A01B 1/20; A01B 1/22; A22C 25/006;  
A47G 21/06; A47G 21/065; A47J 17/02;  
A61B 17/3211; A61B 17/3213; B21D  
53/64; B24D 15/08; B25G 3/36; B26B  
1/00; B26B 1/08; B26B 1/10; B26B 3/00;  
B26B 3/02; B26B 3/03; B26B 3/04;  
B26B 3/06; B26B 5/00; B26B 5/001;  
B26B 5/007; B26B 7/00; B26B 7/005;  
B26B 9/00; B26B 9/02; B26B 11/00;  
B26B 11/006; B26B 17/00; B26B 17/006;  
B26B 29/02; B67B 7/24  
See application file for complete search history.

**OTHER PUBLICATIONS**

Hilton Knife, <http://www.candlepowerforums.com/vb/showthread.php?343017-Another-Spyderco-paramilitary-2-review>, Aug. 23, 2012.  
(Continued)

*Primary Examiner* — Ricky Pham  
(74) *Attorney, Agent, or Firm* — Pearl Cohen Zedek  
Latzter Baratz LLP

(57) **CLAIM**  
The ornamental design for a knife, as shown and described.

**DESCRIPTION**

FIG. 1 is a top, front, right side perspective of a knife;  
FIG. 2 is a right side elevation view of the knife;  
FIG. 3 is a left side elevation view of the knife;  
FIG. 4 is a rear elevation view of the knife;  
FIG. 5 is a front elevation view of the knife;  
FIG. 6 is a top plan view of the knife; and,  
FIG. 7 is a bottom plan view of the knife.  
The broken lines that appear on the drawings form no part of the claimed design and are included for illustrative purposes only.

(56) **References Cited**  
U.S. PATENT DOCUMENTS  
108,141 A 10/1870 Houseman et al.  
165,841 A 7/1875 Kellogg  
173,955 A 2/1876 Hudson

**1 Claim, 3 Drawing Sheets**

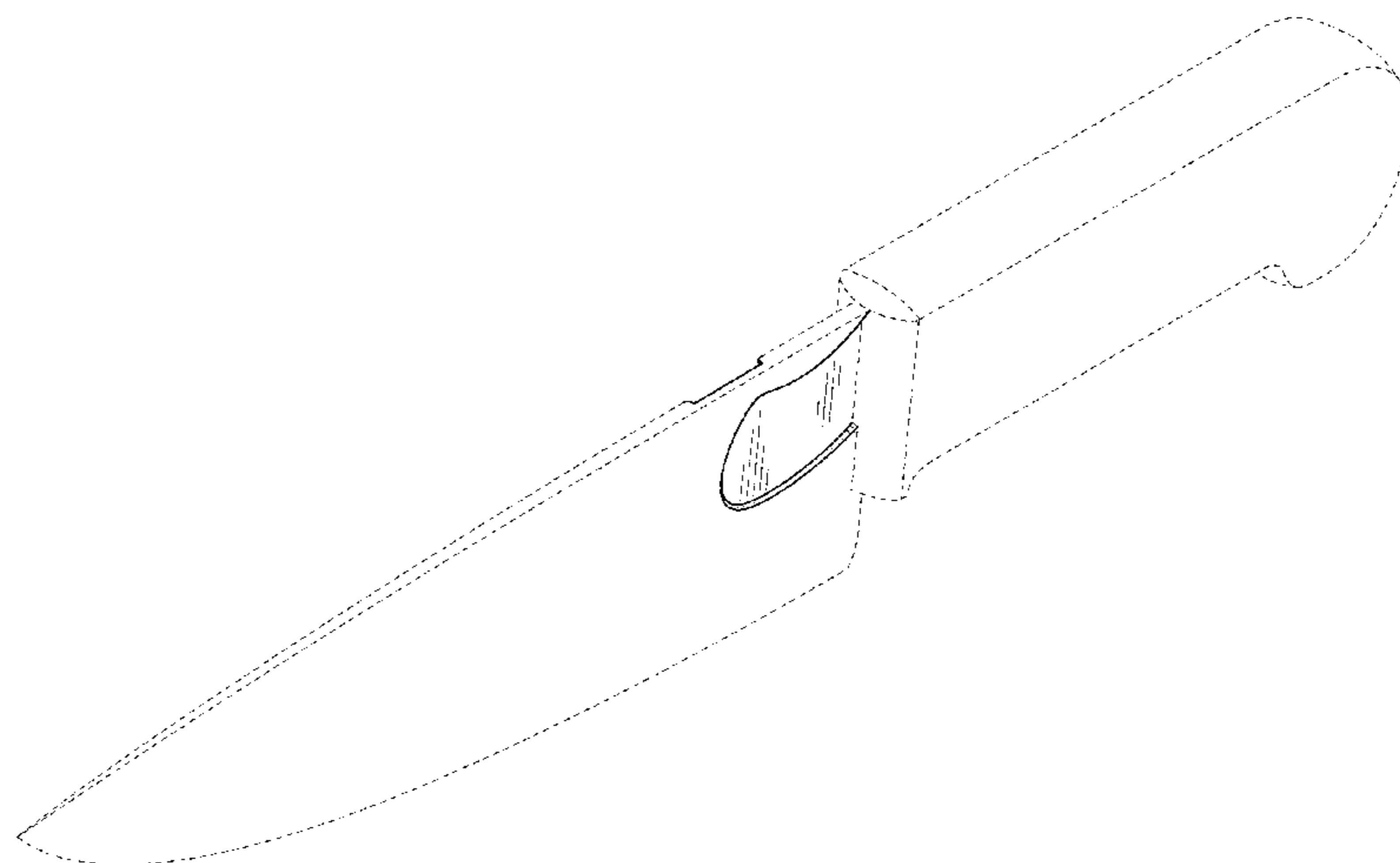

(56)

References Cited

U.S. PATENT DOCUMENTS

492,409 A \* 2/1893 May ..... B26B 29/02  
30/295

D22,439 S 5/1893 McGuigan  
538,459 A 4/1895 McCausland  
605,577 A 6/1898 Hutchinson  
649,059 A 5/1900 Kern  
673,506 A \* 5/1901 Pitts ..... B67B 7/24  
15/143.1

682,624 A \* 9/1901 Klickman ..... B26B 29/02  
30/295

682,938 A 9/1901 Ingram  
725,811 A 4/1903 Asbell  
983,736 A 2/1911 MacOnochie  
1,118,507 A 11/1914 Meyer  
1,299,084 A 4/1919 Wilson  
1,333,960 A 3/1920 Brehm  
1,491,623 A 4/1924 Pitchur  
1,505,444 A 8/1924 Swanson  
1,571,886 A 2/1926 North  
1,602,032 A 10/1926 March  
1,750,577 A \* 3/1930 De Bracht ..... A47J 17/02  
30/295

1,967,479 A 7/1934 Platts  
2,153,759 A 4/1939 Katzinger  
2,168,237 A 8/1939 Polacsek  
2,217,100 A 10/1940 Burns  
D131,224 S 1/1942 Parisi  
2,279,833 A 4/1942 Madan  
2,315,898 A 4/1943 Krilow  
D136,023 S 7/1943 Phillips  
2,467,327 A 4/1949 McKee  
2,494,306 A 1/1950 Morvey  
D173,124 S 9/1954 Niblack  
2,737,719 A 3/1956 Ember et al.  
2,739,498 A 3/1956 Champlin  
D177,743 S \* 5/1956 Marx ..... D7/650  
2,803,876 A 8/1957 Nelson  
D202,780 S 11/1965 Baer  
D235,841 S 7/1975 Cremonese  
D239,623 S 4/1976 Behunin  
D252,790 S 9/1979 Reinschreiber  
4,178,684 A 12/1979 Mightly  
D255,974 S 7/1980 Jacoby  
D262,731 S 1/1982 Austin  
4,578,864 A 4/1986 Hoffman  
D304,154 S \* 10/1989 Osterhout ..... D8/107  
D306,957 S 4/1990 Cohen et al.  
5,365,666 A 11/1994 Gonzalez  
D391,115 S 2/1998 Roberton  
D397,282 S 8/1998 Derkatz  
D405,338 S 2/1999 Balolia  
D439,806 S 4/2001 Juhlin et al.  
D445,643 S 7/2001 Kazaklaris  
D461,681 S 8/2002 Lothe  
D461,688 S 8/2002 Lothe  
6,502,314 B1 1/2003 McCatty  
6,725,545 B2 4/2004 Frank  
D537,850 S 3/2007 Moore et al.  
D538,591 S 3/2007 Ashton, III  
D539,085 S \* 3/2007 Aston, III ..... 8/107  
D539,086 S 3/2007 Aston, III  
D552,430 S 10/2007 Chen  
D554,949 S 11/2007 Hood

7,302,760 B2 12/2007 Lake  
7,434,320 B2 10/2008 Aston, III  
D600,506 S 9/2009 Miltner et al.  
D612,694 S 3/2010 Eide et al.  
D643,256 S 8/2011 Hirai  
D643,257 S 8/2011 Hirai  
D643,260 S \* 8/2011 Spiegel ..... D7/649  
D643,261 S 8/2011 Spiegel  
8,082,669 B2 12/2011 Hayes  
D677,551 S 3/2013 Pelton  
8,584,365 B2 11/2013 Zeitlin  
8,707,490 B1 4/2014 Pelton  
8,732,958 B2 5/2014 Huang  
D719,405 S 12/2014 Miller  
8,931,381 B2 1/2015 Poran  
8,943,935 B2 2/2015 Qian  
9,132,559 B2 9/2015 Hatch et al.  
D750,948 S 3/2016 Pelton  
D766,672 S 9/2016 Mishan  
D766,673 S 9/2016 Mishan  
D766,674 S 9/2016 Mishan  
D774,354 S 12/2016 Scobey, Jr.  
D781,666 S 3/2017 Mishan  
D790,287 S \* 6/2017 Singer ..... D7/401.2  
D790,288 S \* 6/2017 Singer ..... D7/401.2  
D790,289 S \* 6/2017 Singer ..... D7/401.2  
D790,290 S \* 6/2017 Singer ..... D7/401.2  
D795,639 S \* 8/2017 Singer ..... D7/401.2

2002/0170184 A1 11/2002 Lothe  
2003/0182808 A1 10/2003 Mireles  
2005/0241111 A1 11/2005 Prokop  
2012/0159793 A1 6/2012 Hatch et al.  
2013/0104403 A1 5/2013 Stokes  
2016/0193742 A1 7/2016 Faiola  
2016/0375598 A1 12/2016 Singer

FOREIGN PATENT DOCUMENTS

DE 29914226 U1 11/1999  
KR 20090007796 U 8/2009

OTHER PUBLICATIONS

Jade Knife, <http://andy321.proboards.com/thread/50295/jade-knife>, Feb. 1, 2012.  
Tac-Force TF-578BK Karambit A/O Finger Ring Knife, <http://www.moosecreekgear.com/tac-force-tf578bk-karambit-ao-linerlock-knife.html>, last accessed Jun. 25, 2015.  
Gerber Myth Pocket Folder Knife, <http://www.amazon.com/Gerber-Myth-Pocket-Folder-Knife/dp/B00P6M07B4>, last accessed Jun. 25, 2015.  
High Desert Survival School Knife, <http://jasonklass.blogspot.in/2011/05/high-desert-survival-school-knife.html>, last accessed Jun. 25, 2015.  
Notice of Allowance of Design U.S. Appl. No. 29/548,734 dated Apr. 17, 2017.  
Notice of Allowance of Design U.S. Appl. No. 29/548,770 dated Apr. 18, 2017.  
Notice of Allowance of Design U.S. Appl. No. 29/548,797 dated Apr. 19, 2017.  
Notice of Allowance of Design U.S. Appl. No. 29/550,397 dated Apr. 18, 2017.

\* cited by examiner

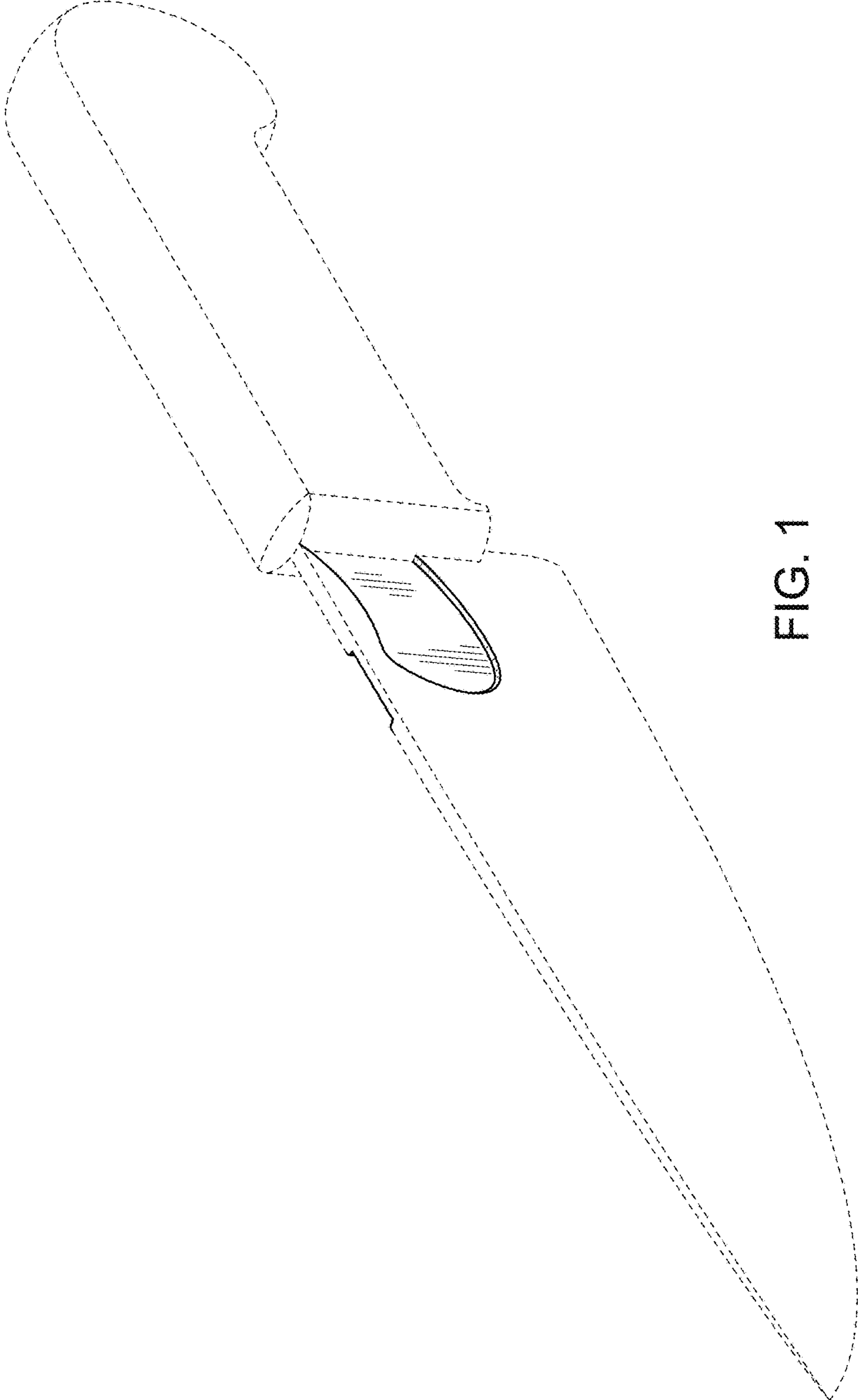

FIG. 1

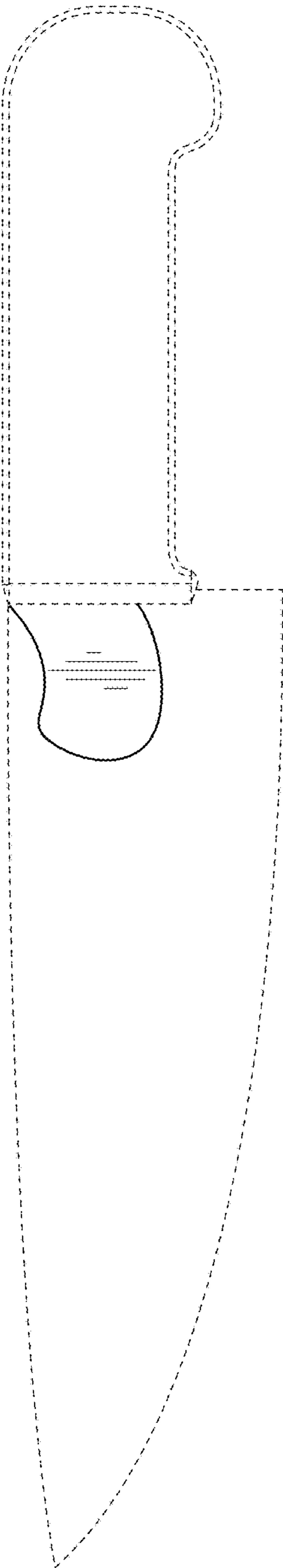

FIG. 2

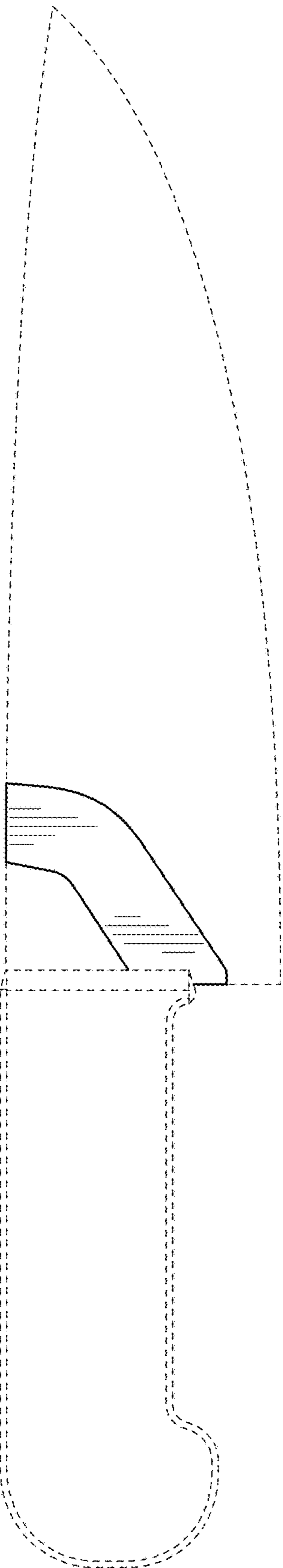

FIG. 3



FIG. 4

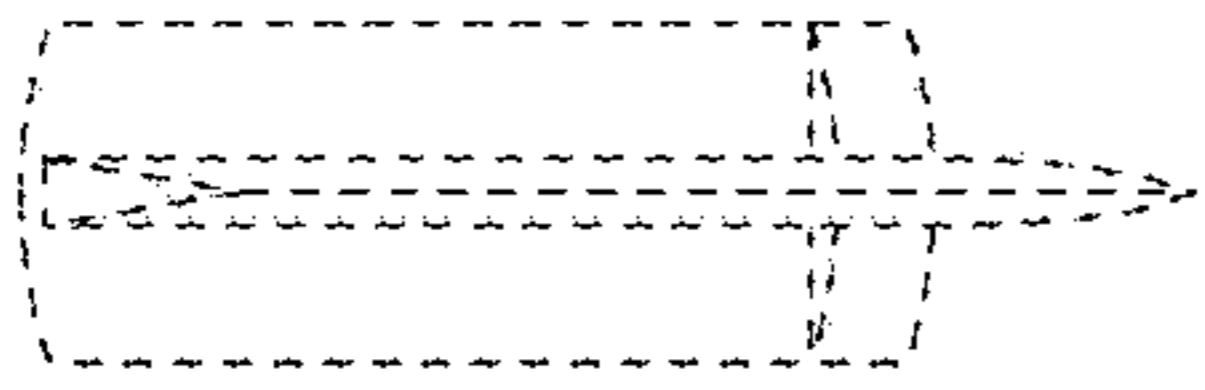

FIG. 5

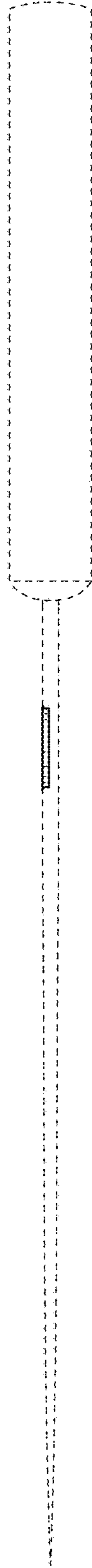

FIG. 6

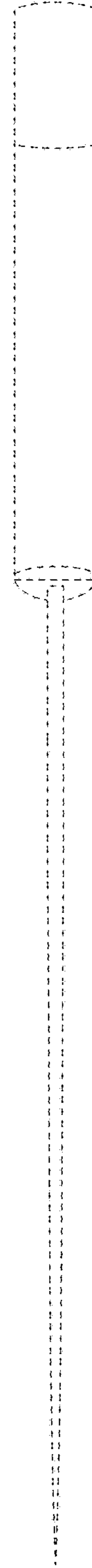

FIG. 7