



US00D810458S

(12) **United States Design Patent**
Cartier

(10) **Patent No.:** **US D810,458 S**

(45) **Date of Patent:** **** Feb. 20, 2018**

(54) **BED COMPONENT**

(71) Applicant: **Ryan Cartier**, Calgary (CA)

(72) Inventor: **Ryan Cartier**, Calgary (CA)

(**) Term: **15 Years**

(21) Appl. No.: **29/592,603**

(22) Filed: **Jan. 31, 2017**

(51) **LOC (11) Cl.** **06-02**

(52) **U.S. Cl.**
USPC **D6/384**; D6/382; D6/718

(58) **Field of Classification Search**
USPC D6/382-384, 392, 718, 718.4
CPC A47C 19/00; A47C 19/005; A47C 19/021;
A47C 19/025; A47C 19/027; A47C 17/86
See application file for complete search history.

(56) **References Cited**

U.S. PATENT DOCUMENTS

| | | | | | |
|-----------|-----|---------|-----------|-------|--------------|
| 3,338,648 | A * | 8/1967 | Bannister | | A47B 83/00 |
| | | | | | 312/195 |
| D251,520 | S * | 4/1979 | Staed | | D6/382 |
| 4,780,919 | A * | 11/1988 | Harrison | | A61G 7/02 |
| | | | | | 5/308 |
| 5,687,652 | A * | 11/1997 | Ruma | | B65D 19/0012 |
| | | | | | 108/57.25 |
| D420,834 | S * | 2/2000 | Anderson | | D6/675 |
| D458,767 | S * | 6/2002 | Baeriswyl | | D6/382 |
| D495,160 | S * | 8/2004 | Dordoni | | D6/384 |
| D546,578 | S * | 7/2007 | Juneau | | D6/393 |
| D608,560 | S * | 1/2010 | Chen | | D6/384 |
| D608,562 | S * | 1/2010 | Chen | | D6/384 |

(Continued)

OTHER PUBLICATIONS

Urban Outfitters Border Storage Platform Bed, Bestproducts.com, Mar. 24, 2017, site visited Sep. 19, 2017, available online at

<http://www.bestproducts.com/home/decor/g563/best-storage-beds-frames/> (Year: 2017).*
Expedite Bed Frame, IKEA Hackers, May 7, 2011, site visited Sep. 19, 2017, available online at <http://www.ikeahackers.net/2011/05/expedite-re-purposed-as-bed-frame-for-maximum-storage.html> (Year: 2011).*

(Continued)

Primary Examiner — Cathron C Brooks

(57) **CLAIM**

I claim the ornamental design for a bed component, as shown and described.

DESCRIPTION

FIG. 1 is a top, front, right side perspective view of a bed component embodying my design;
FIG. 2 is a bottom, front, right side perspective view thereof;
FIG. 3 is a top plan view thereof;
FIG. 4 is a front elevation view thereof, the rear elevation view being the same;
FIG. 5 is a right side view thereof, the left side view being the same;
FIG. 6 is a top, front, right side perspective view of a second embodiment of my bed component design;
FIG. 7 is a bottom, front, right side perspective view thereof;
FIG. 8 is a top plan view thereof;
FIG. 9 is a front elevation view thereof, the rear elevation view being the same;
FIG. 10 is a right side view thereof, the left side view being the same;
FIG. 11 is a top front, right side perspective view of a third embodiment of my bed component design;
FIG. 12 is a bottom, front, right side perspective view thereof;
FIG. 13 is a top plan view thereof;
FIG. 14 is a front elevation view thereof, the rear elevation view being the same; and,
FIG. 15 is a right side view thereof, the left side view being the same.

The broken lines in the Figures depict environmental subject matter that forms no part of the claimed design.

1 Claim, 12 Drawing Sheets

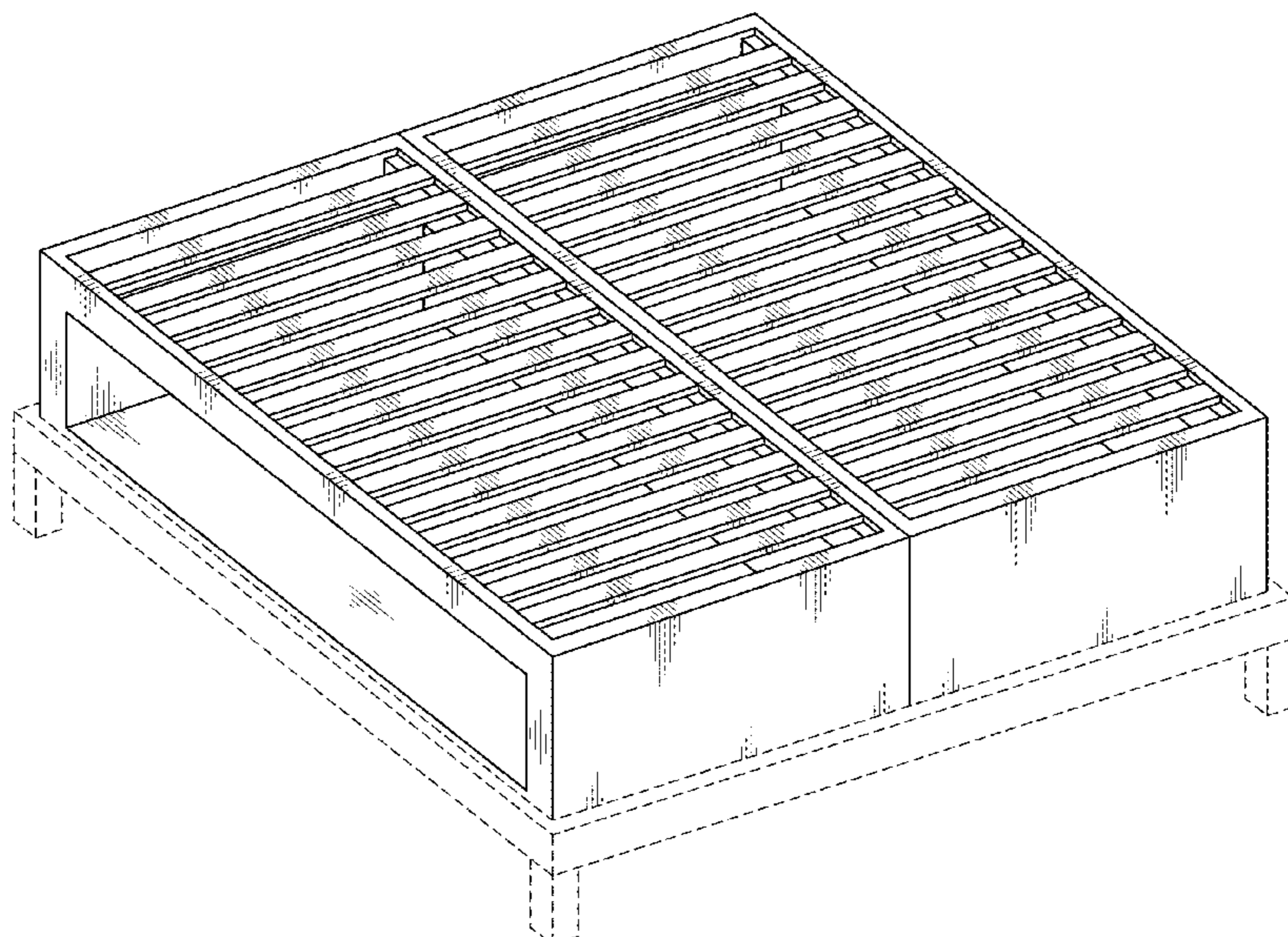

(56)

References Cited

U.S. PATENT DOCUMENTS

D646,500 S * 10/2011 Szekely D6/382
9,661,933 B2 * 5/2017 Karl A47C 27/144
2002/0112653 A1 * 8/2002 Moore, Jr. B65D 19/0012
108/57.25
2017/0238715 A1 * 8/2017 Choi A47C 19/025

OTHER PUBLICATIONS

Blu Dot Modulicious Storage Beds, Apartmenttherapy.com, Feb. 7, 2007, site visited Sep. 20, 2017, available online at <http://www.apartmenttherapy.com/bludots-modulic-17630> (Year: 2007).*

Jörg Schellmann, "Schellmann Bed", <http://raw.abduzeedo.com/post/29897738534/schellmann-bed-is-a-minimalist-design-created-by>, date unknown, 2 pages.

Boyd Eurobas, "Boyd Specialty Sleep Euro Base Platform Bed Frame Eastern King Dimensions", http://msexta.com/eastern-king-bed-dimensions/boyd-specialty-sleep-euro-base-platform-bed-frame-eastern-king-dimensions-boyd_eurobas/, date unknown, 8 pages.

Leonardo Dainelli, "Urano: The Floating Bed by Falegnameria 1946", https://www.furniturefashion.com/urano_the_floating_bed_by_falegnameria_1946/, date unknown, 3 pages.

Jules Yap, "Finally, a Cal-King Bed Frame with space for dog kennels", <http://www.ikeahackers.net/2012/07/finally-a-cal-king-bed-frame-with-space-for-dog-kennels.html>, Jul. 5, 2012, 11 pages.

Jules Yap, "Expedite re-purposed as bed frame for maximum storage", <http://www.ikeahackers.net/2011/05/expedit-re-purposed-as-bed-frame-for-maximum-storage.html>, May 7, 2011, 8 pages.

* cited by examiner

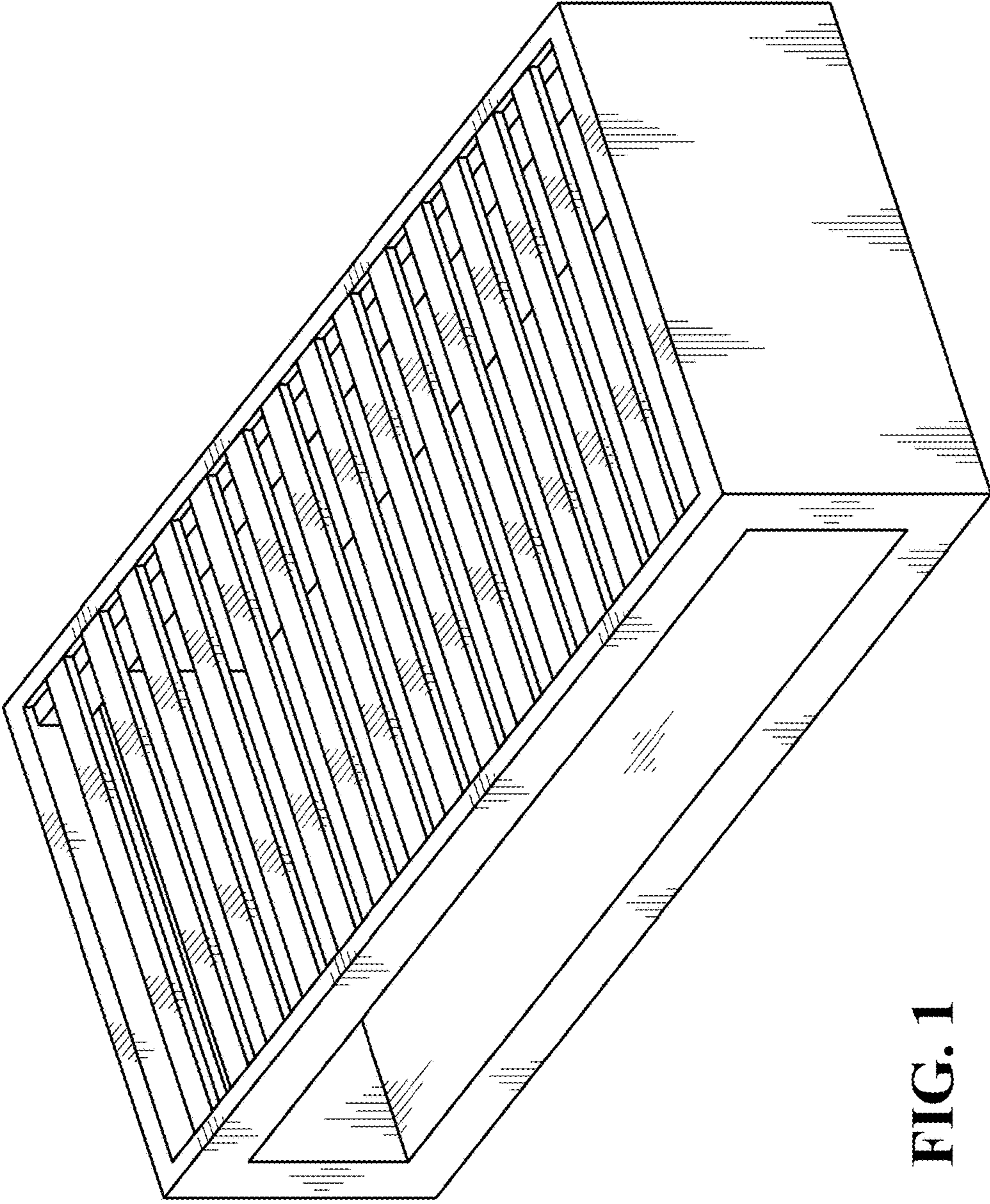

FIG. 1

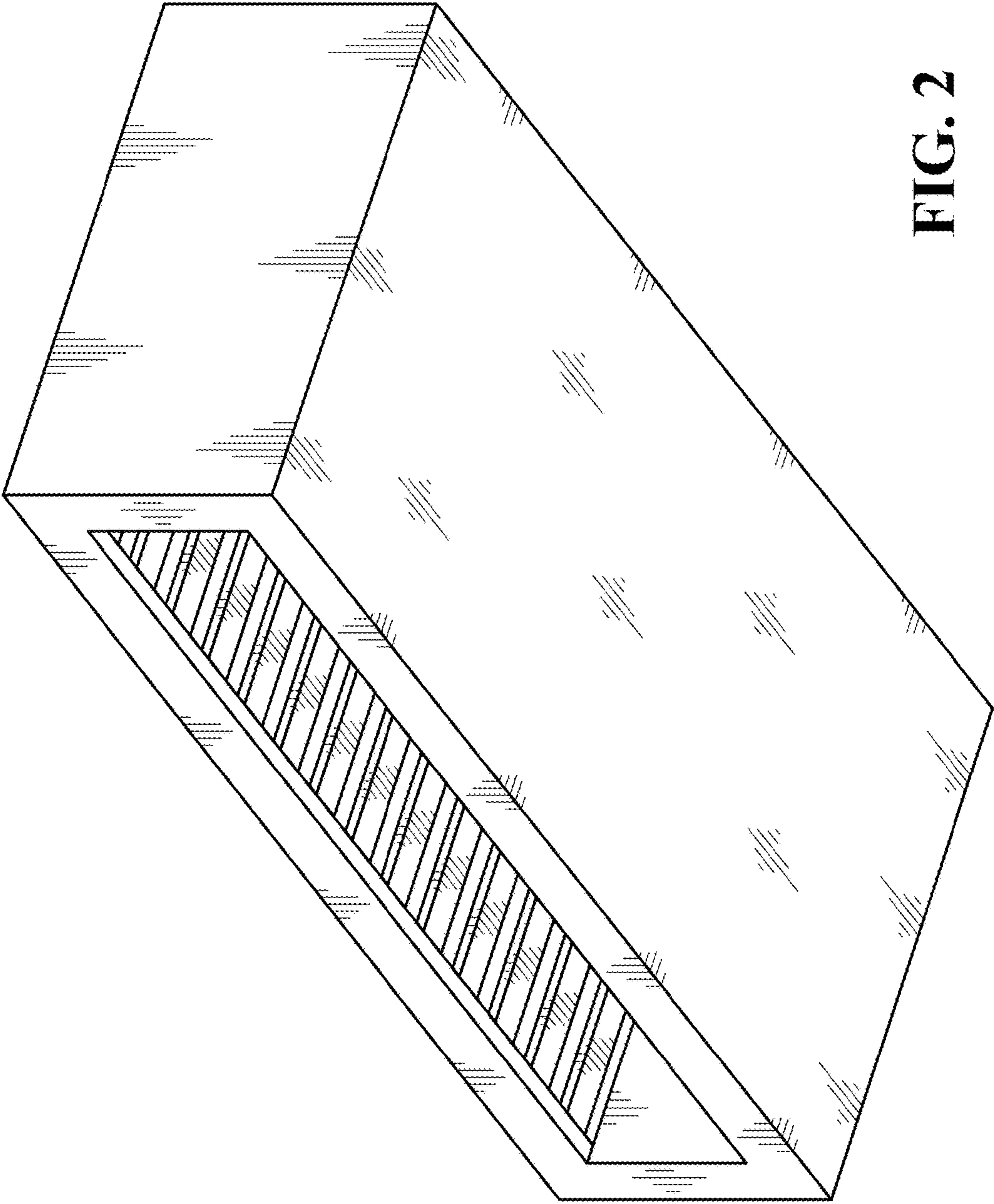

FIG. 2

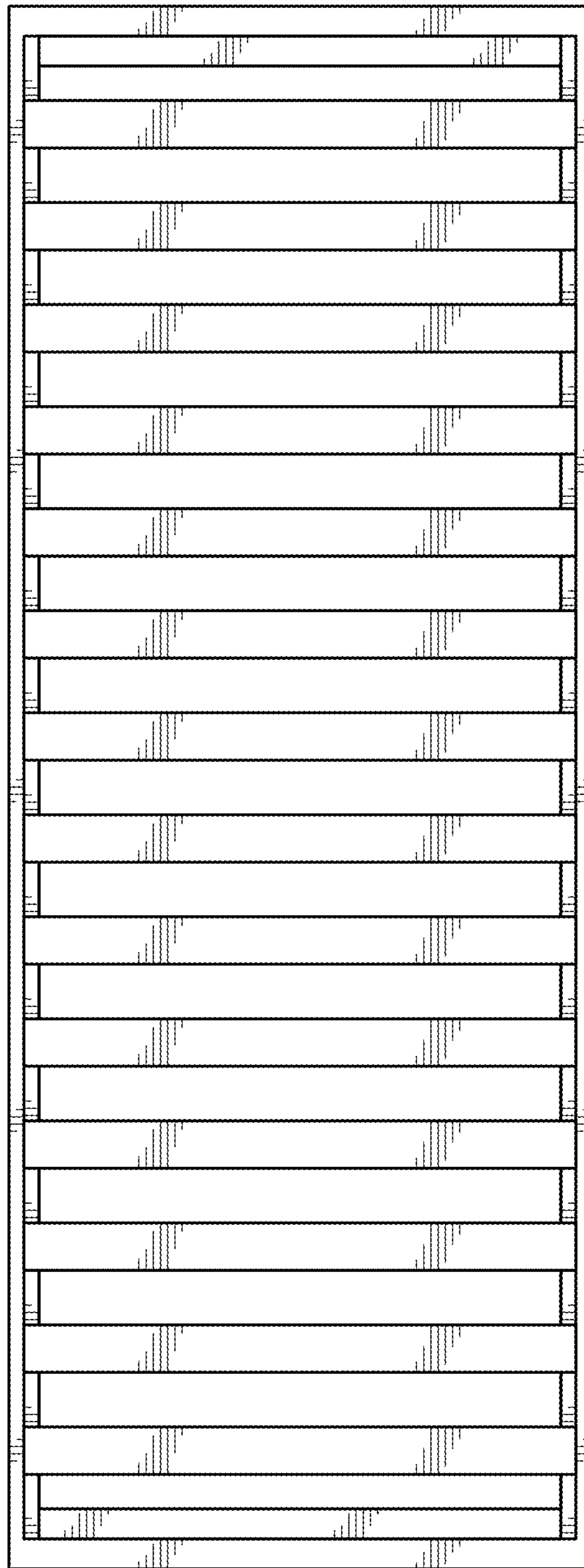

FIG. 3

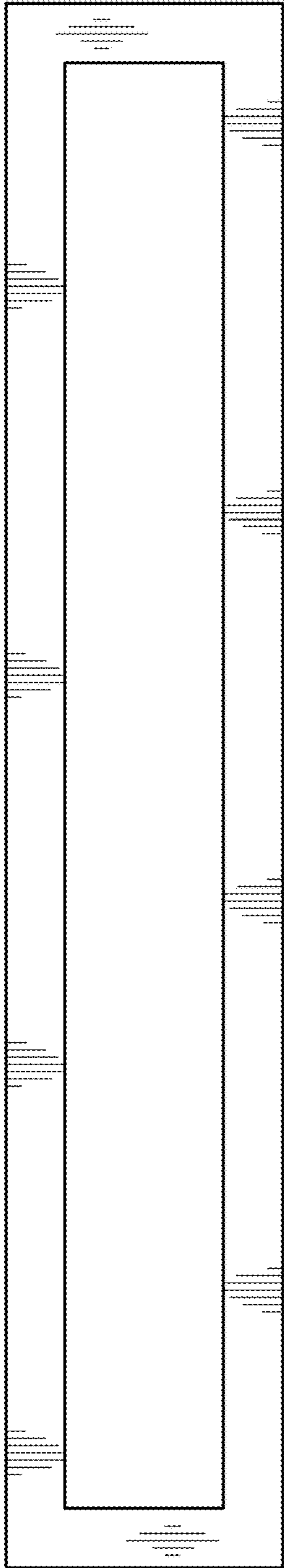

FIG. 4

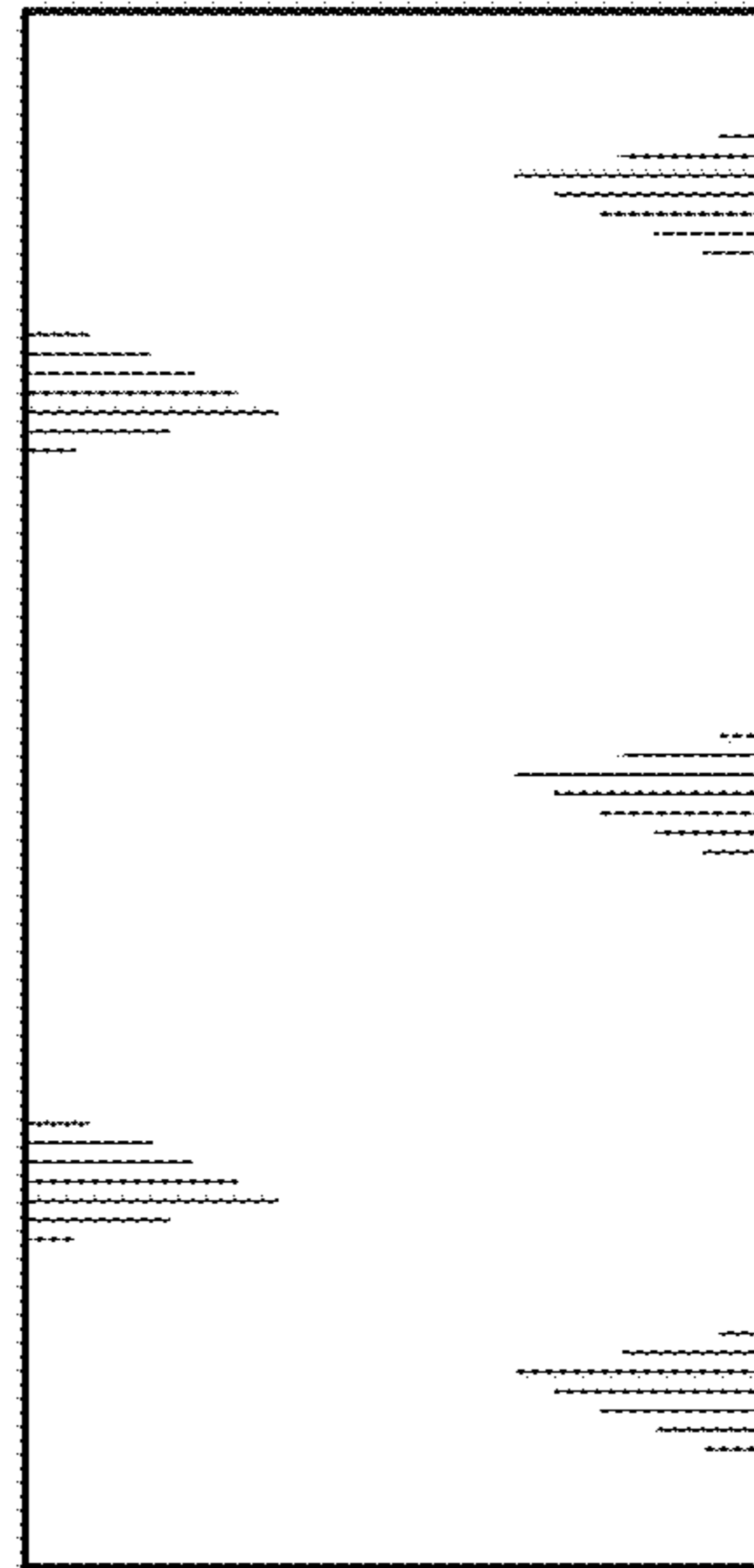

FIG. 5

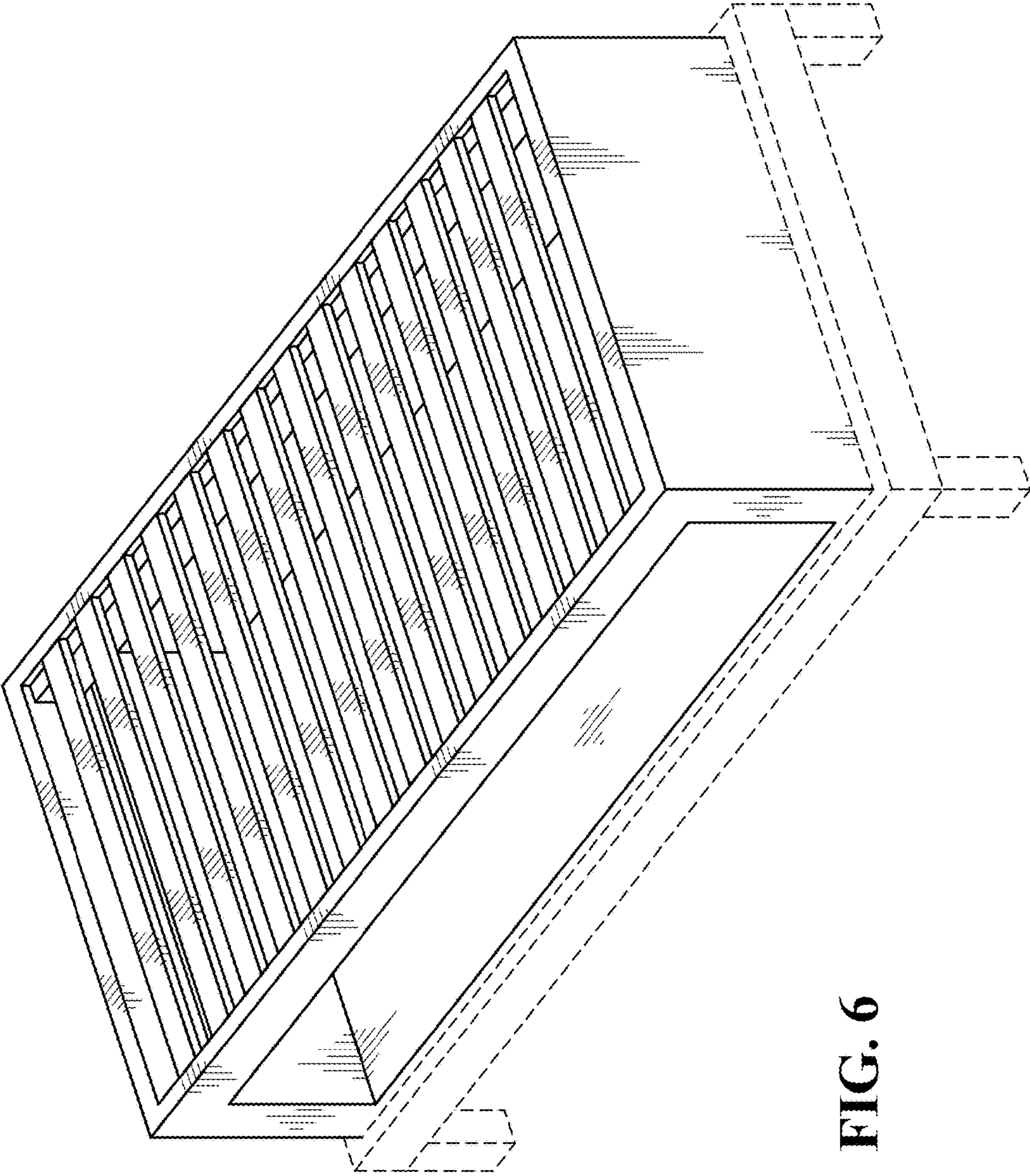

FIG. 6

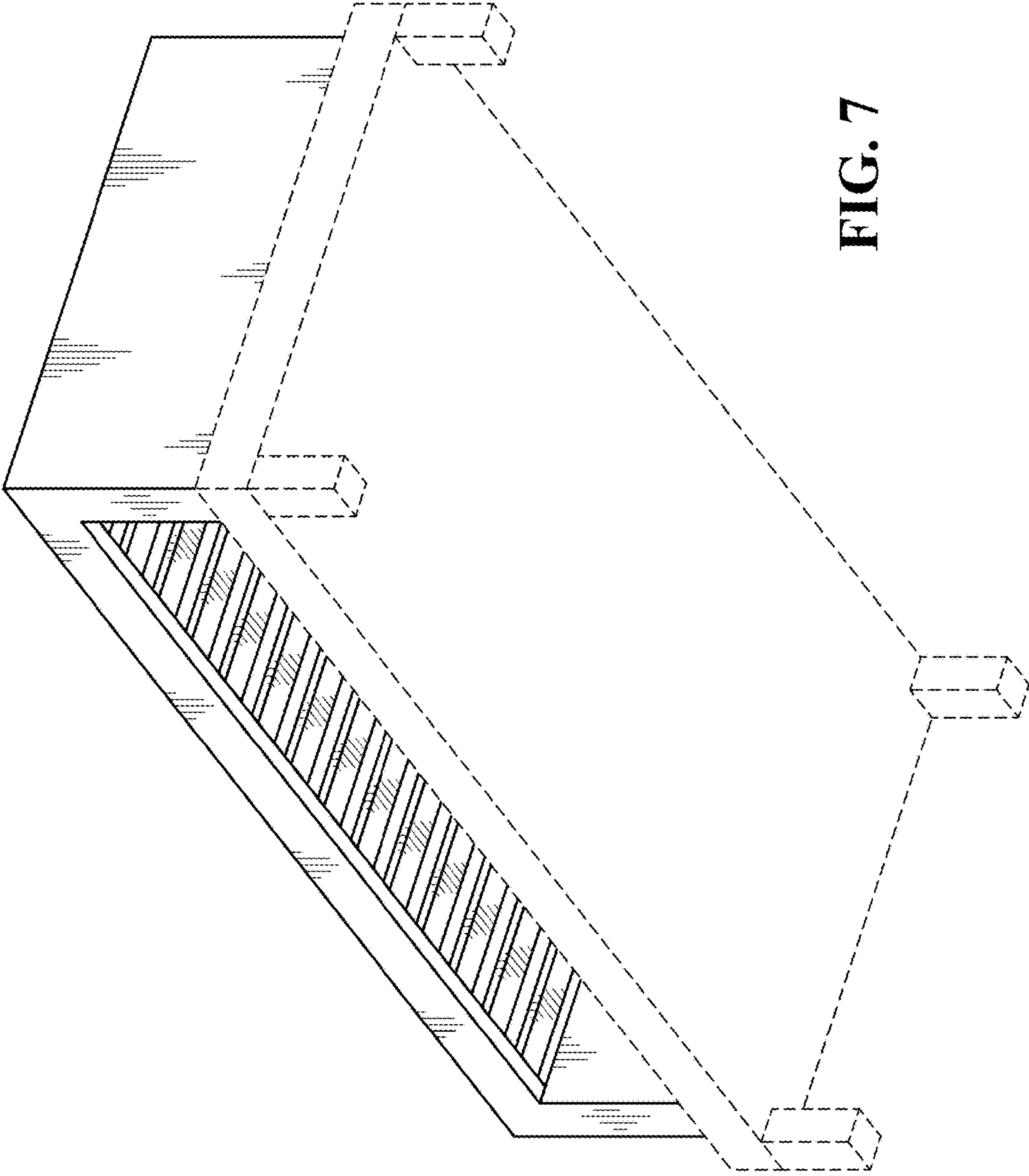

FIG. 7

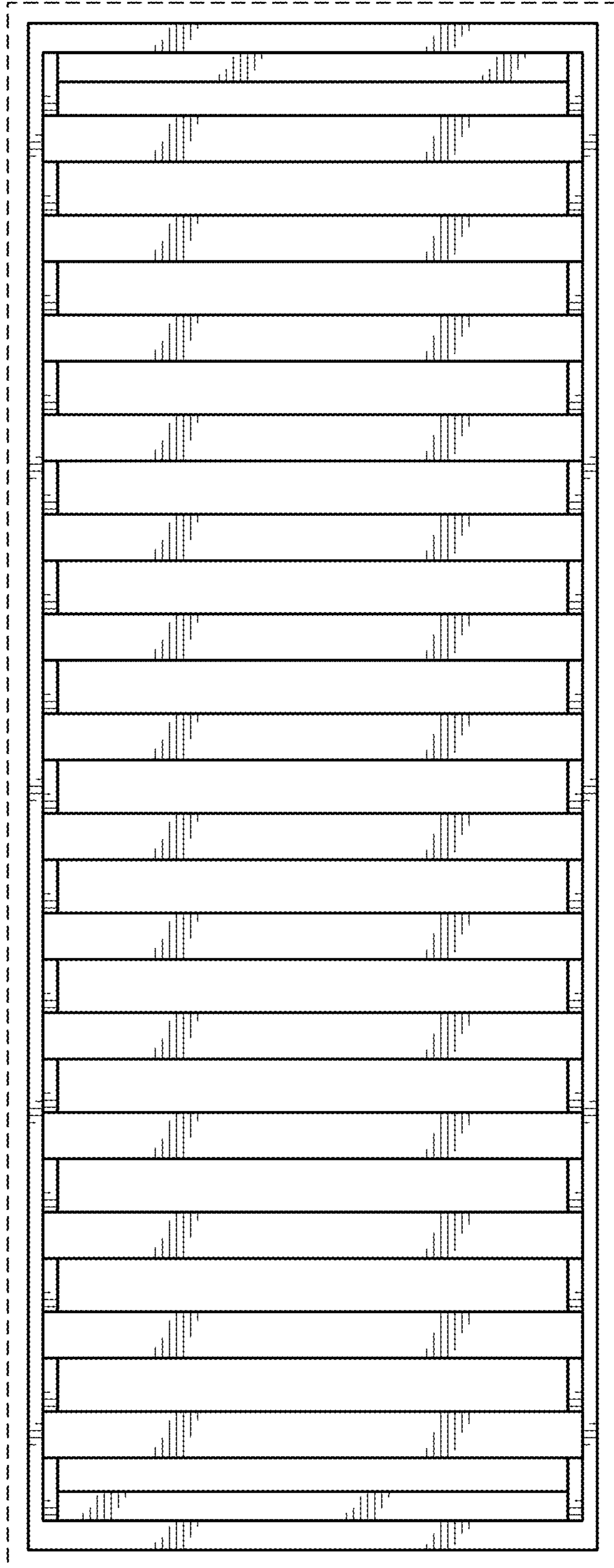

FIG. 8

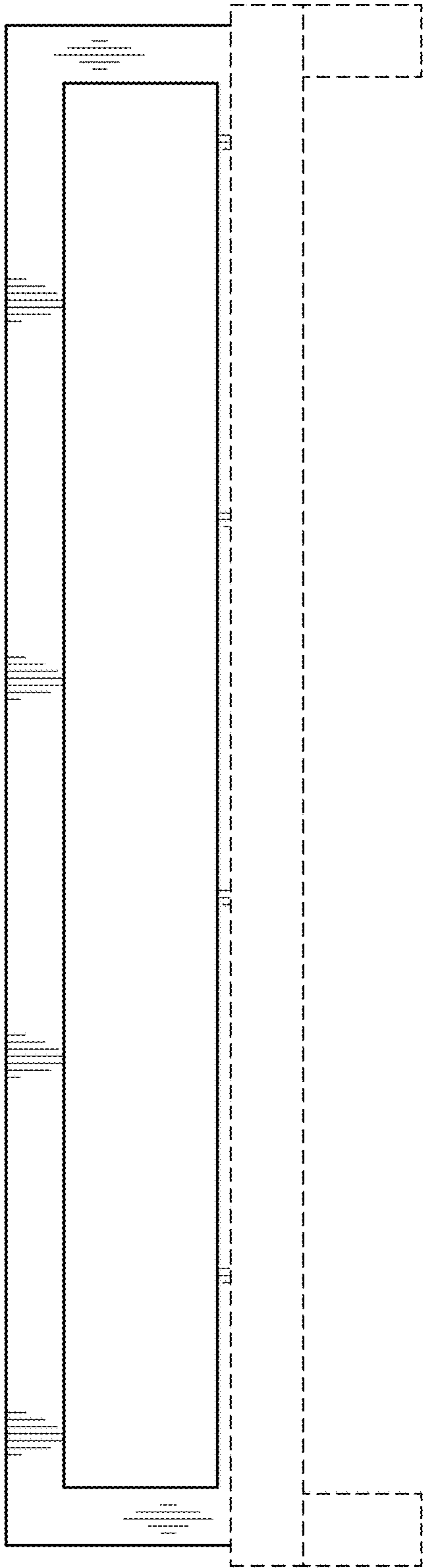

FIG. 9

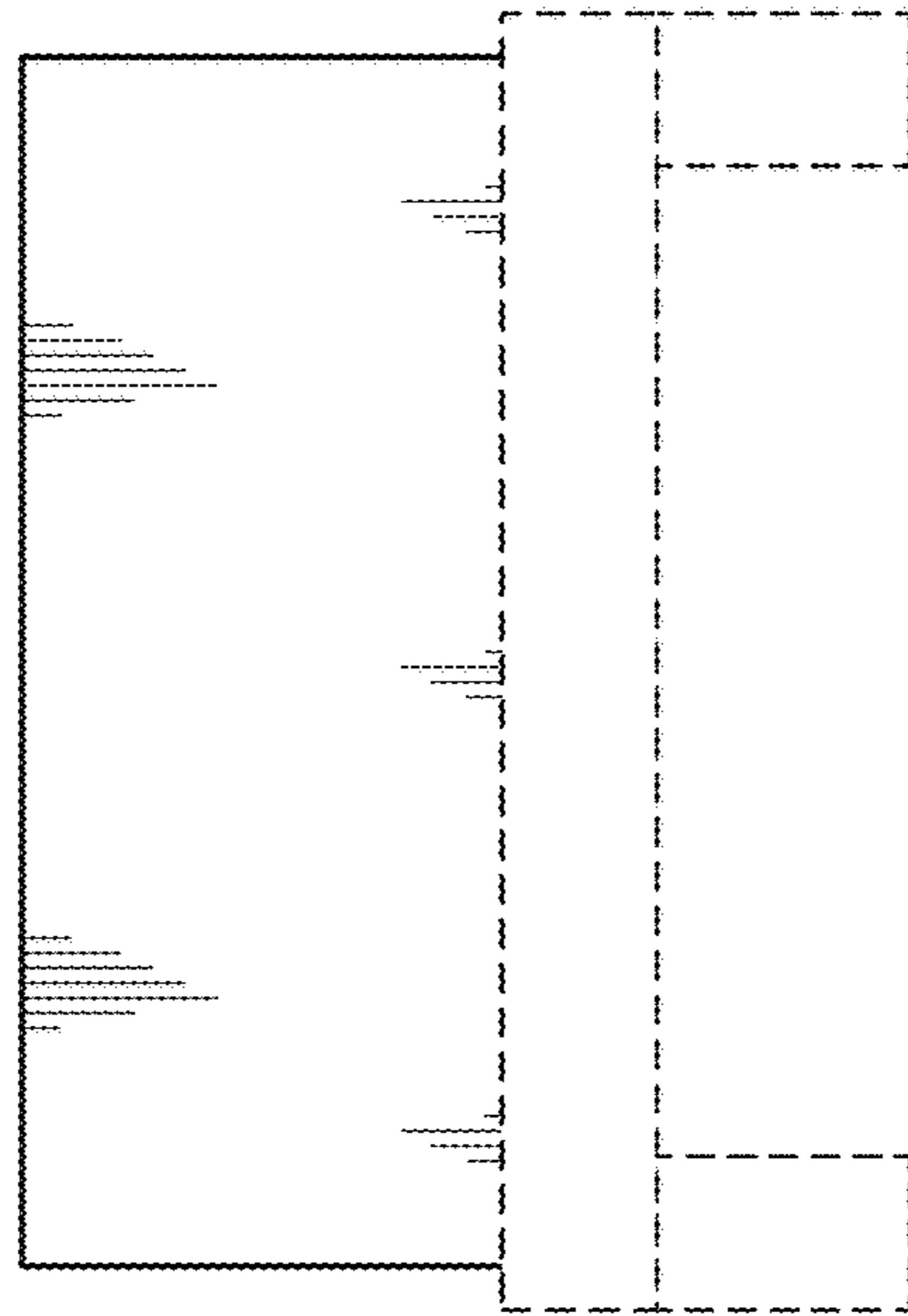

FIG. 10

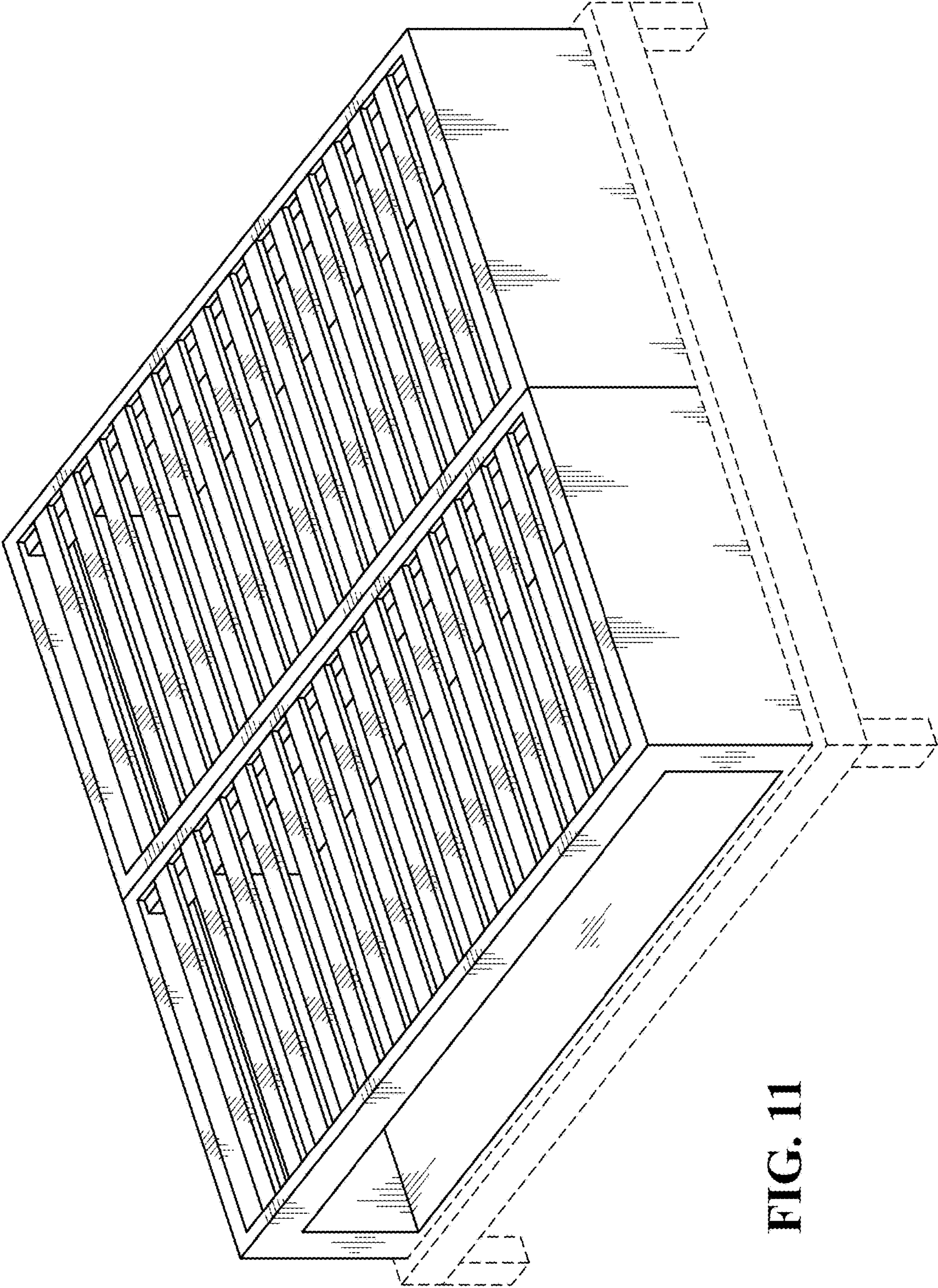

FIG. 11

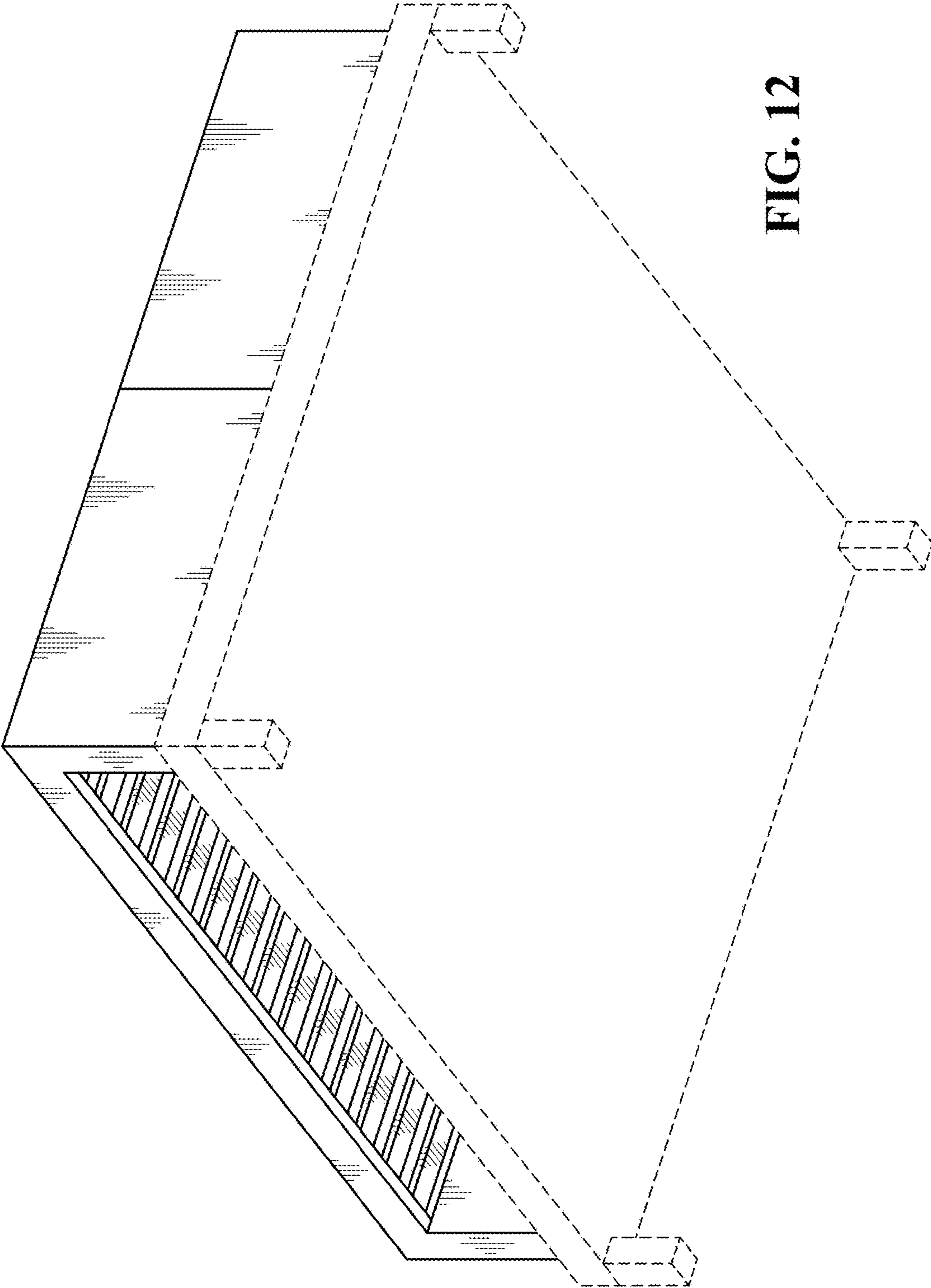

FIG. 12

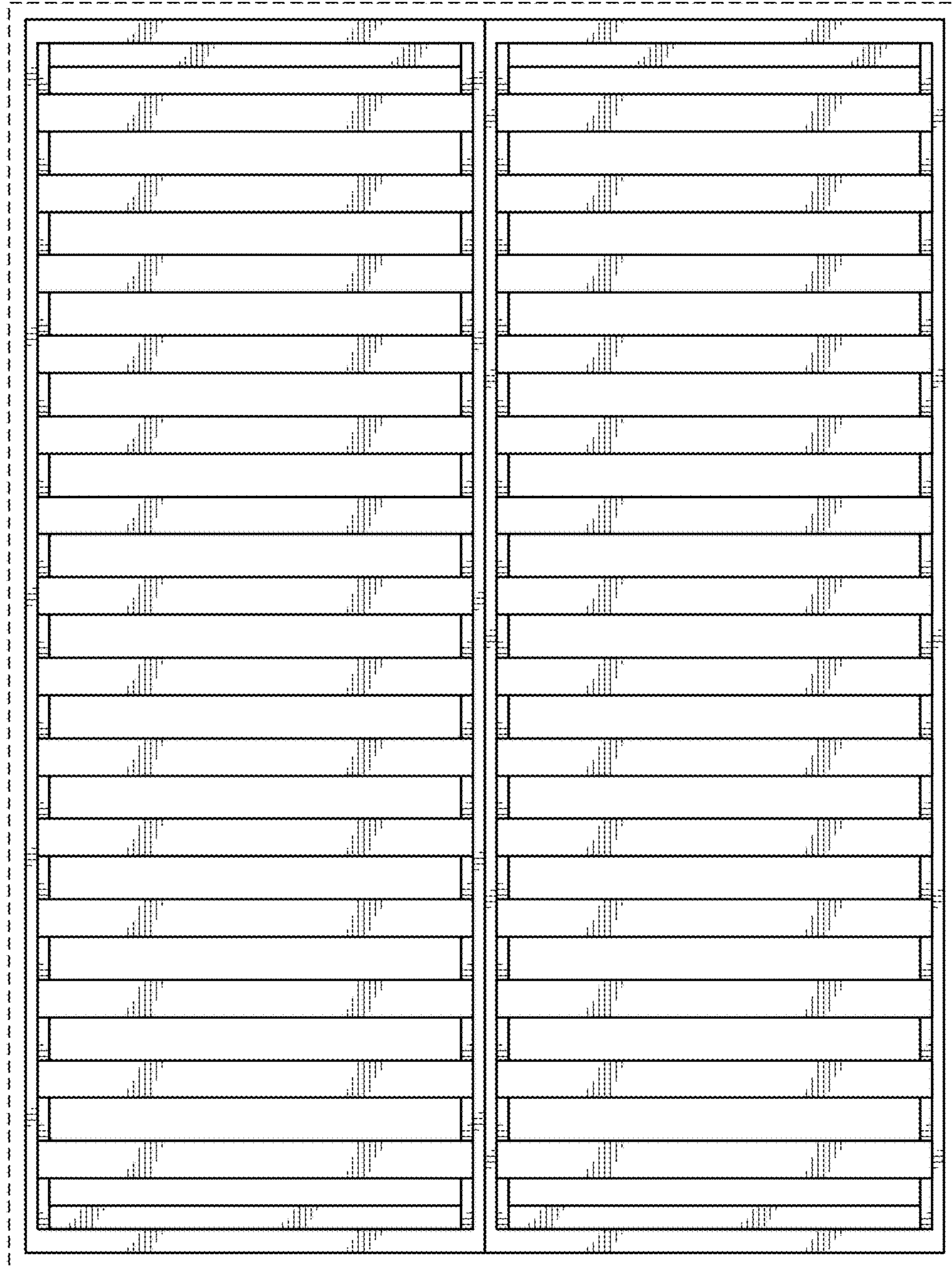

FIG. 13

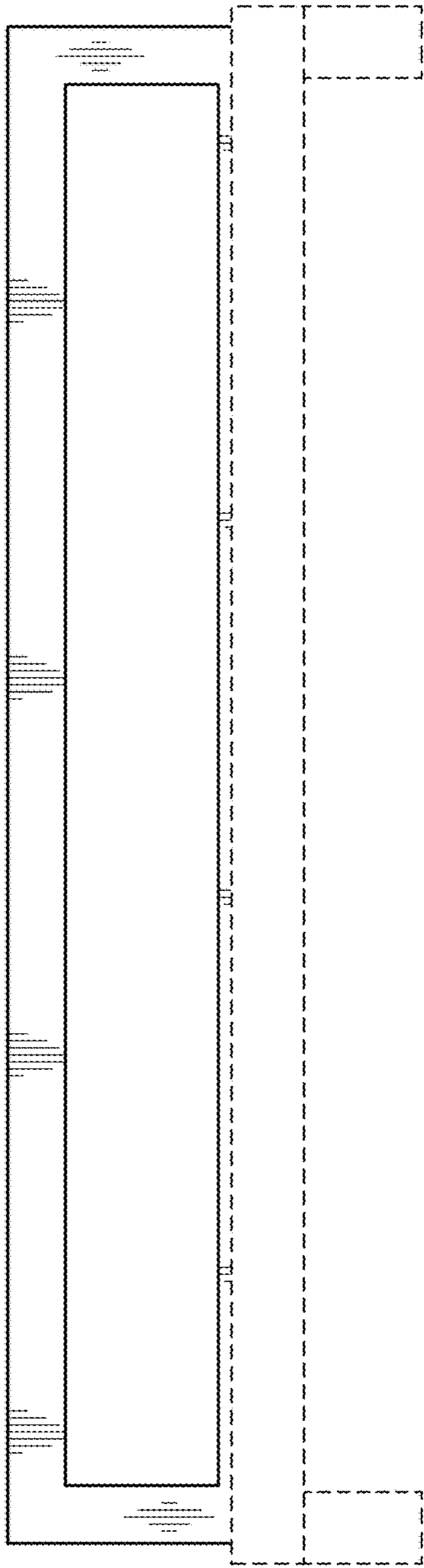

FIG. 14

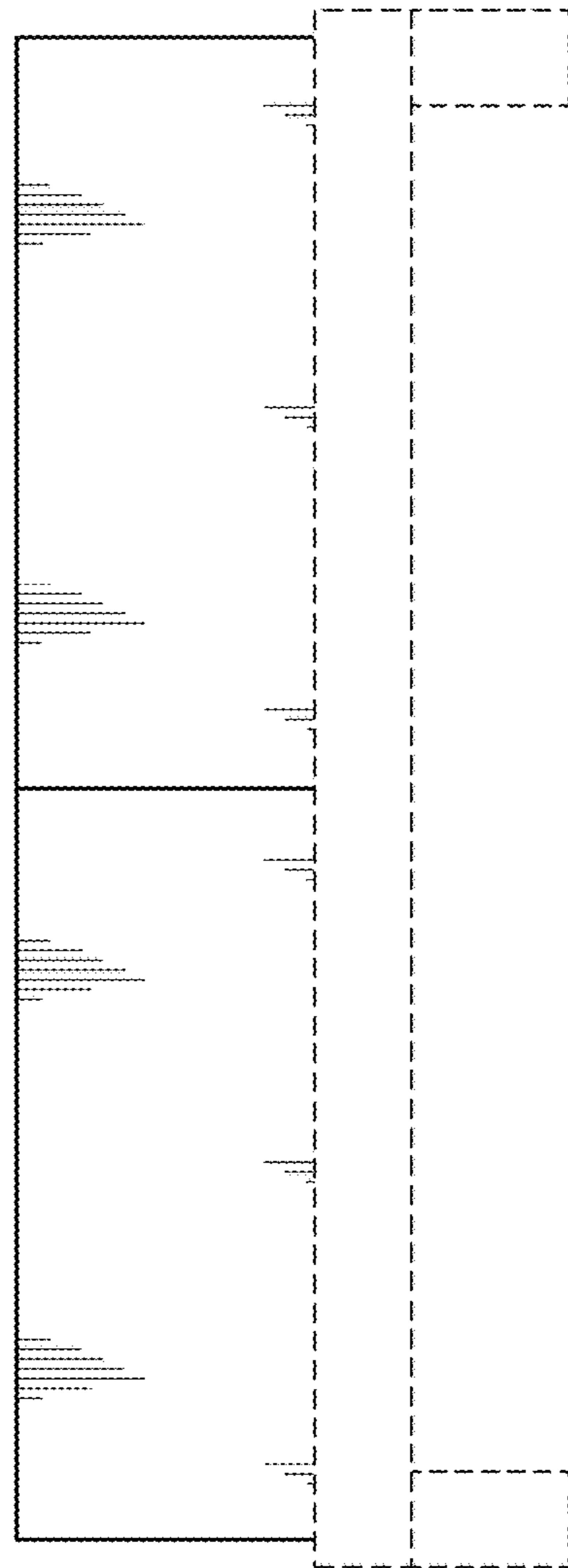

FIG. 15