



US00D810394S

(12) **United States Design Patent**  
**Falcone**

(10) **Patent No.:** **US D810,394 S**

(45) **Date of Patent:** **\*\* Feb. 20, 2018**

(54) **FOOD PRODUCT**

(71) Applicant: **Mars, Incorporated**, McLean, VA (US)

(72) Inventor: **Vincent Joseph Falcone**, Inverness, IL (US)

(73) Assignee: **Mars, Incorporated**, McLean, VA (US)

(\*\*) Term: **15 Years**

(21) Appl. No.: **29/569,848**

(22) Filed: **Jun. 30, 2016**

(51) **LOC (11) Cl.** ..... **01-01**

(52) **U.S. Cl.**  
USPC ..... **D1/199**

(58) **Field of Classification Search**  
USPC ..... D1/100-130, 199; 426/5, 76, 87, 92, 94, 426/95, 99, 101, 103, 108, 138-139, 143, 426/144, 279, 282, 283, 391, 514, 549, 426/660; D13/100; D24/101-104; D28/8.1; 424/467; 425/195; 34/296; D6/601; D9/453  
CPC .. A61K 9/2072; A61K 9/0004; A61K 9/2095; A61K 9/209  
See application file for complete search history.

(56) **References Cited**

**U.S. PATENT DOCUMENTS**

D16,030 S	4/1885	Schwarzschild et al.	
D18,206 S	3/1888	Schwarzschild et al.	
1,319,899 A *	10/1919	Rafert .....	A21C 11/12 426/76
2,103,083 A	12/1937	Lynch	
D207,167 S	3/1967	Fisher	
4,109,649 A	8/1978	Iyomasa	
D303,728 S	10/1989	Spanier et al.	
D305,950 S	2/1990	Spiel et al.	
D305,952 S	2/1990	Spanier et al.	

D320,495 S	10/1991	Pallesen	
5,240,720 A	8/1993	Axelrod	
D338,993 S	9/1993	Lilly	
5,553,570 A	9/1996	Vannatter, III et al.	
D383,782 S	9/1997	Decker	
5,832,877 A	11/1998	Markham	
6,116,191 A	9/2000	Suchowski et al.	
6,168,822 B1	1/2001	Reicks et al.	
D460,601 S	7/2002	Tenzer	
D469,238 S *	1/2003	Bedi .....	D1/121

(Continued)

**OTHER PUBLICATIONS**

PetCare Advertisement, IAMS Tartar Treats, Mar. 2006.

*Primary Examiner* — Garth Rademaker

*Assistant Examiner* — Katie Stofko

(74) *Attorney, Agent, or Firm* — Greenberg Traurig, LLP

(57) **CLAIM**

The ornamental design for a food product, as shown and described.

**DESCRIPTION**

FIG. 1 is a perspective view of a food product showing my new design;

FIG. 2 is a front view of the food product shown in FIG. 1;

FIG. 3 is a rear view of the food product shown in FIG. 1;

FIG. 4 is a left side view of the food product shown in FIG. 1;

FIG. 5 is a right side view of the food product shown in FIG. 1;

FIG. 6 is a top view of the food product shown in FIG. 1; and,

FIG. 7 is a bottom view of the food product shown in FIG. 1.

The broken lines shown in FIGS. 1-7 illustrate portions of the food product that form no part of the claimed design.

**1 Claim, 7 Drawing Sheets**

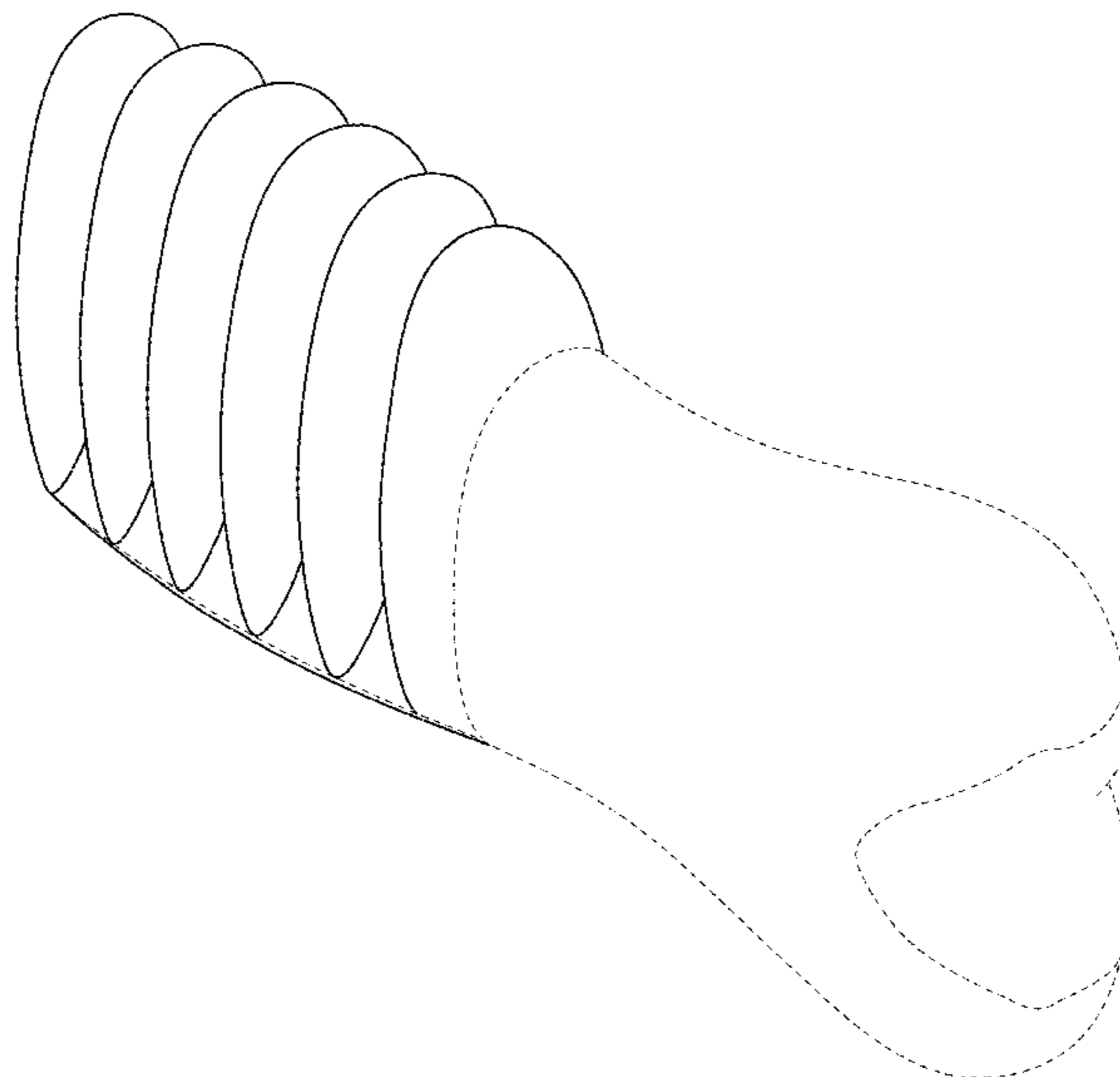

(56)

References Cited

U.S. PATENT DOCUMENTS

D481,867 S *	11/2003	Hotz .....	D3/271.2	D590,127 S *	4/2009	Caudill .....	D1/125
D499,226 S	12/2004	Axelrod		D603,127 S	11/2009	Townsend et al.	
D501,286 S	2/2005	Wang		D603,578 S	11/2009	Townsend et al.	
D503,998 S	4/2005	Axelrod		D635,326 S	4/2011	Freije	
D528,736 S	9/2006	Koenig et al.		D638,606 S	5/2011	Freije	
D529,667 S	10/2006	Axelrod		D639,526 S *	6/2011	Allen .....	D1/125
D530,481 S	10/2006	Koenig et al.		D687,950 S	8/2013	Gitman	
D531,365 S	10/2006	Axelrod		D694,964 S	12/2013	Axelrod	
D531,383 S	11/2006	Dettmer et al.		8,925,494 B2 *	1/2015	Pang .....	A01K 15/026 119/709
D536,506 S	2/2007	Unlu		D740,518 S	10/2015	Rivadeneira et al.	
D584,477 S *	1/2009	Caudill .....	D1/125	D745,241 S	12/2015	Doerr	
D587,427 S	3/2009	Torney et al.		D747,465 S	1/2016	Homsy et al.	
D587,428 S	3/2009	Torney et al.		2006/0102099 A1	5/2006	Edwards	
D587,429 S	3/2009	Torney et al.		2006/0222748 A1	10/2006	Kobayashi et al.	
7,497,189 B2 *	3/2009	Torney .....	A01K 15/026 119/709	2007/0101946 A1	5/2007	Penny	
				2008/0041320 A1 *	2/2008	Torney .....	A01K 15/026 119/709
				2015/0320072 A1	11/2015	Bufton et al.	

\* cited by examiner

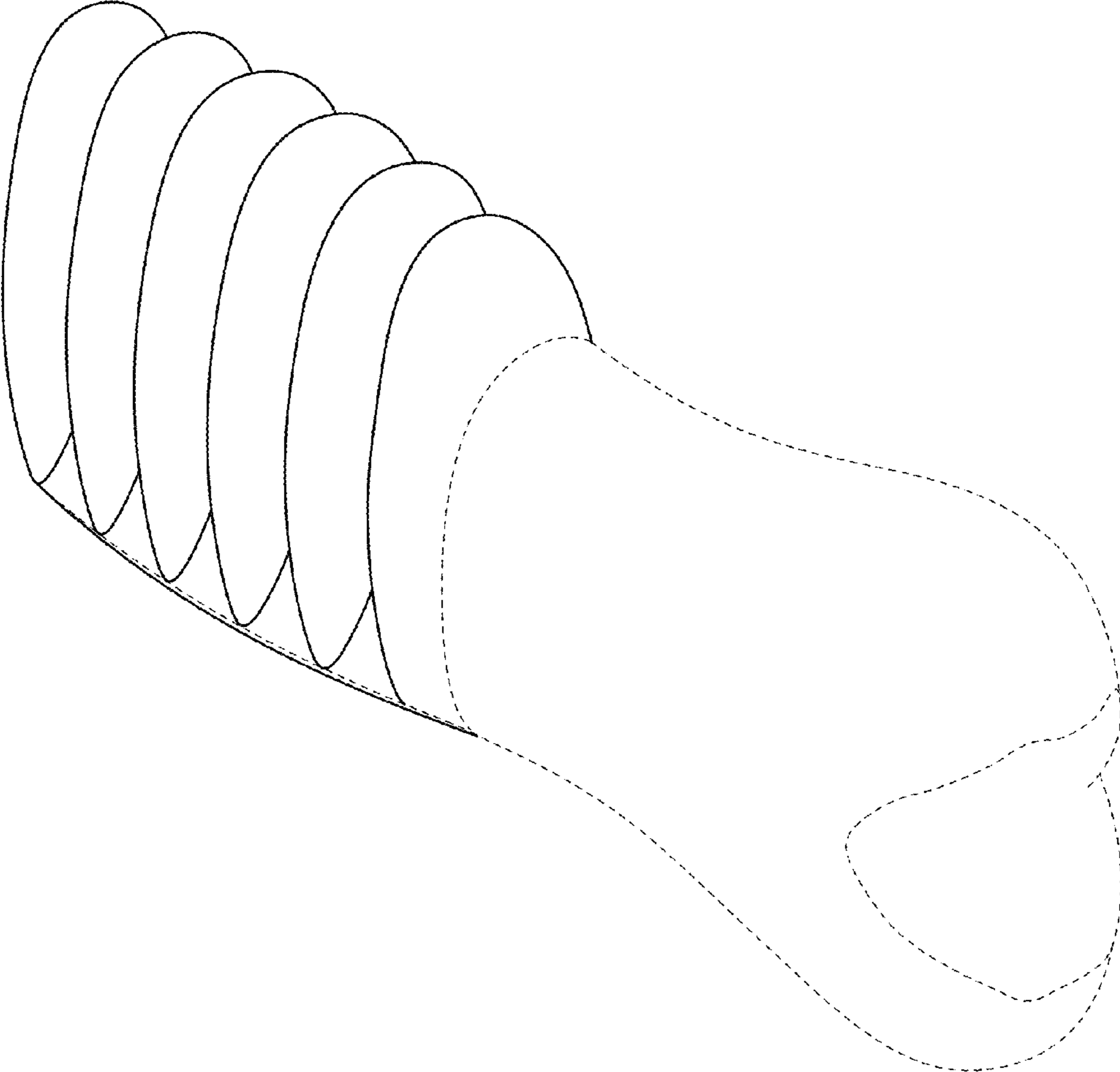

FIG. 1

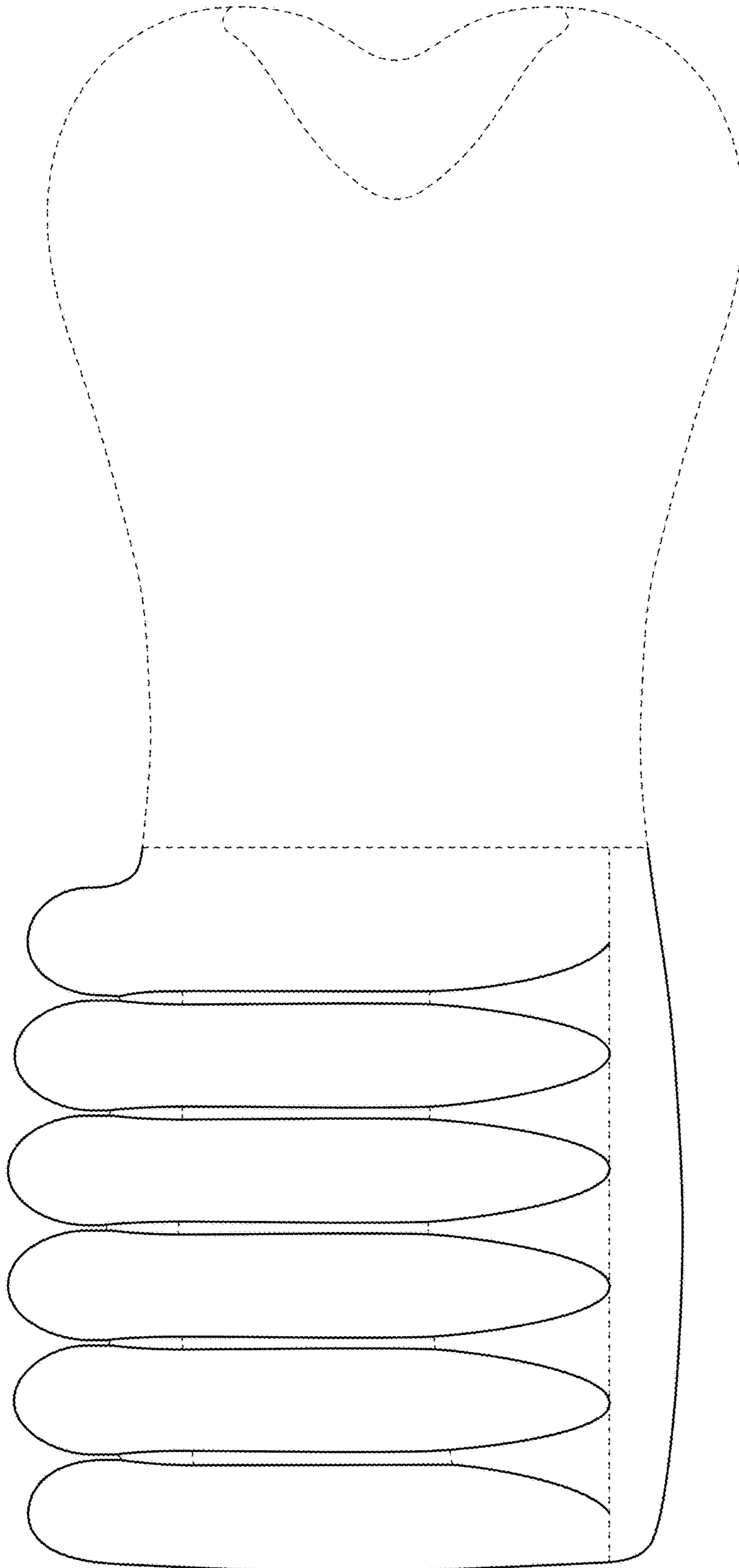

FIG. 2

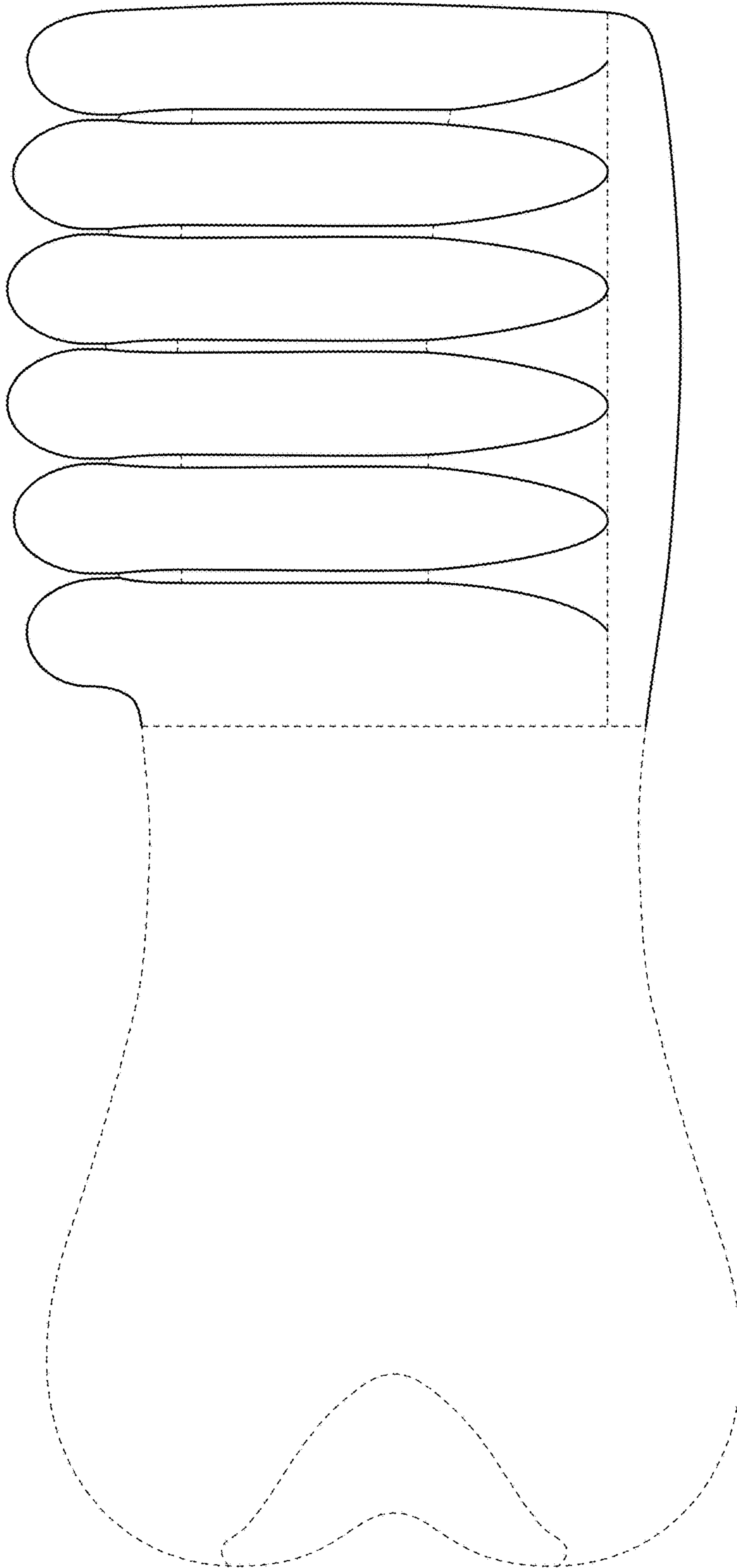

FIG. 3

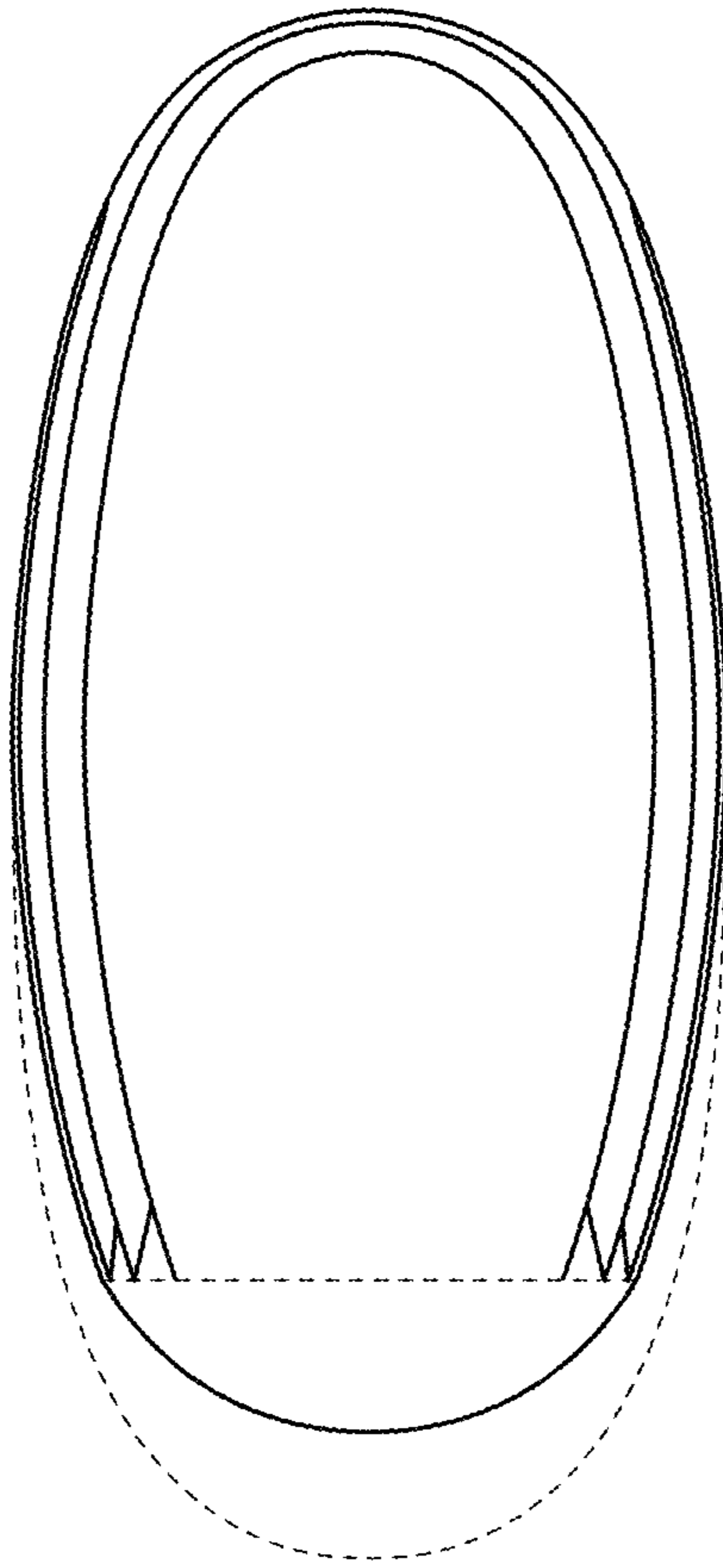

FIG. 4

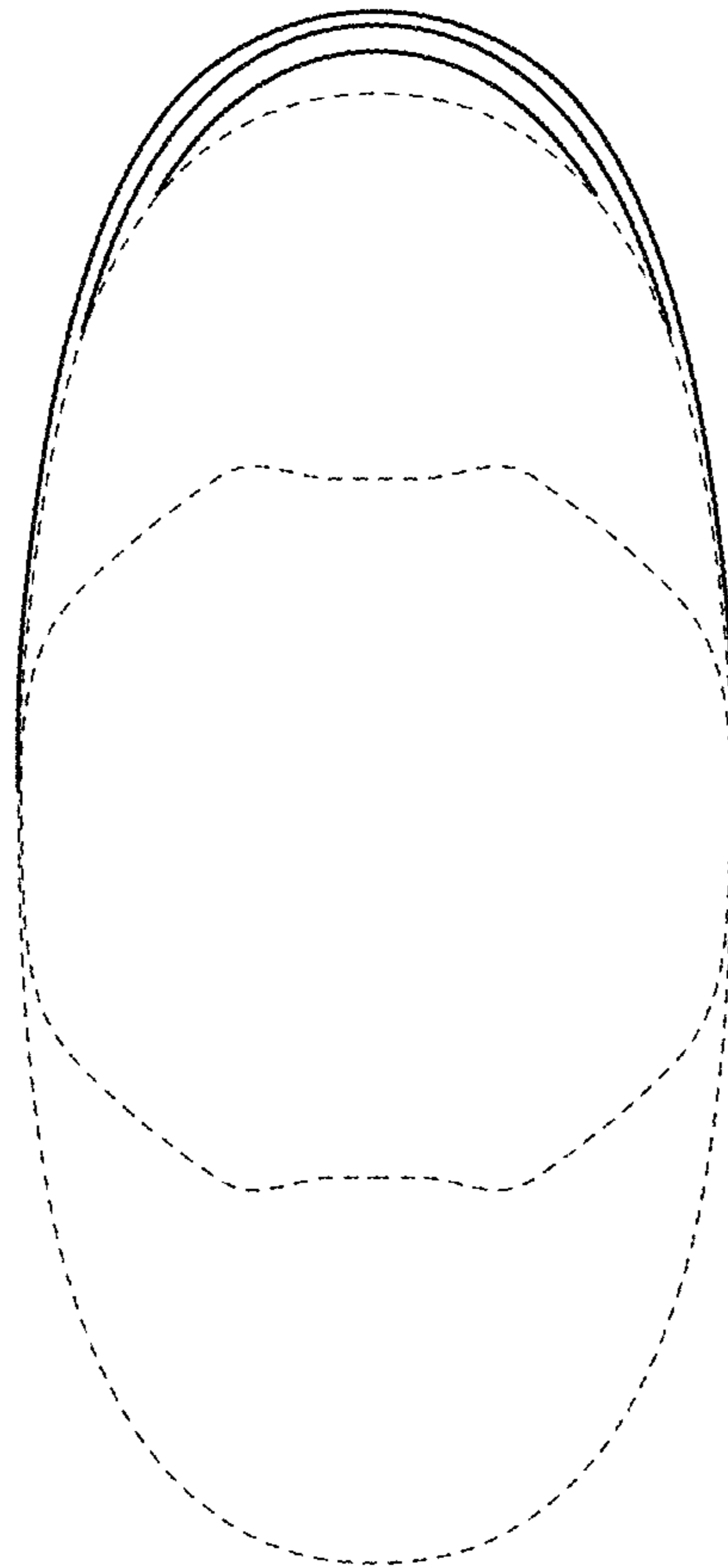

FIG. 5

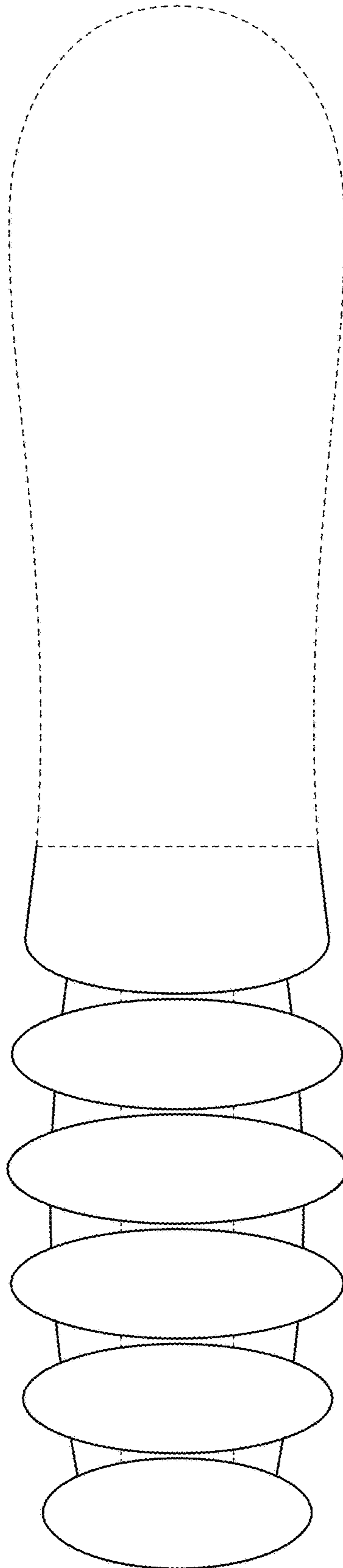

FIG. 6



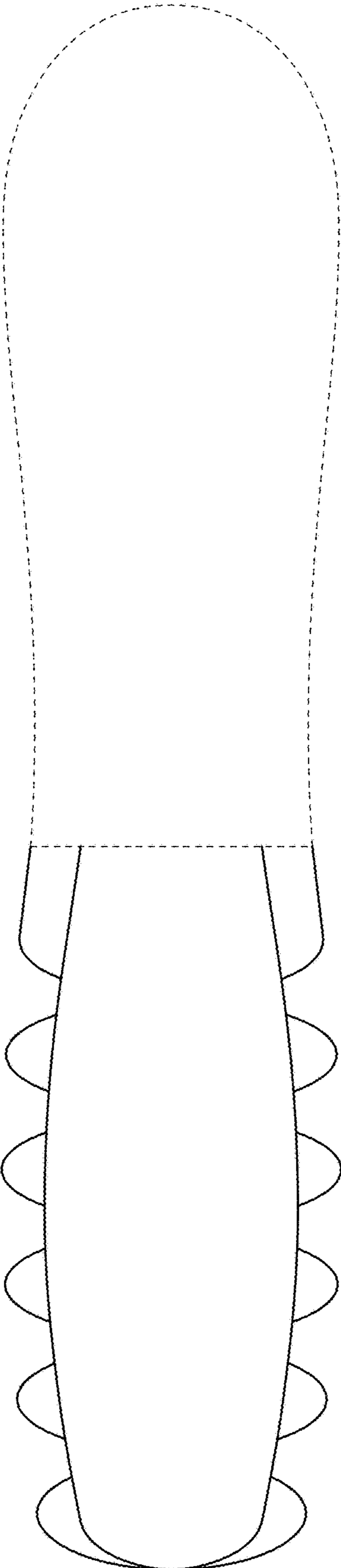

FIG. 7