



US00D810291S

(12) **United States Design Patent**  
**Genender et al.**

(10) **Patent No.:** **US D810,291 S**  
(45) **Date of Patent:** **\*\* Feb. 13, 2018**

(54) **SKIN STAPLER**

- (71) Applicant: **Medline Industries, Inc.**, Mundelein, IL (US)
- (72) Inventors: **Alan Genender**, Northbrook, IL (US); **Yogesh Wadhwa**, Vernon Hills, IL (US); **Derek Roberts**, Chicago, IL (US); **Michael Turturro**, Arlington Heights, IL (US)
- (73) Assignee: **Medline Industries, Inc.**, Northfield, IL (US)

- (\*\*) Term: **15 Years**
- (21) Appl. No.: **29/569,400**
- (22) Filed: **Jun. 27, 2016**

**Related U.S. Application Data**

- (63) Continuation of application No. 29/503,564, filed on Sep. 26, 2014, now Pat. No. Des. 770,619.
- (51) **LOC (11) Cl.** ..... **24-02**
- (52) **U.S. Cl.**  
USPC ..... **D24/145**
- (58) **Field of Classification Search**  
USPC ..... D24/145, 133, 146-147; D8/49, 68;  
227/175.1, 180.1, 901-902; 606/139,  
606/142, 143, 170  
CPC ..... A61B 17/0684; A61B 17/0401; A61B  
17/0469  
See application file for complete search history.

(56) **References Cited**

**U.S. PATENT DOCUMENTS**

- 4,204,623 A \* 5/1980 Green ..... B25C 5/16  
227/121
- D327,323 S \* 6/1992 Hunt ..... D24/145
- 5,330,087 A \* 7/1994 Murray ..... A61B 17/0684  
227/175.1

(Continued)

**OTHER PUBLICATIONS**

“Medline Catalog”, Absorbable GIA Skin Stapler by Covidien; Medline Catalog; <http://www.medline.com/catalog/catalog.jsp>; Unknown Publication date but believed to be prior to present application filing date.

(Continued)

*Primary Examiner* — Wan Laymon  
*Assistant Examiner* — Mark Booker

(74) *Attorney, Agent, or Firm* — Philip H. Burrus, IV

(57) **CLAIM**

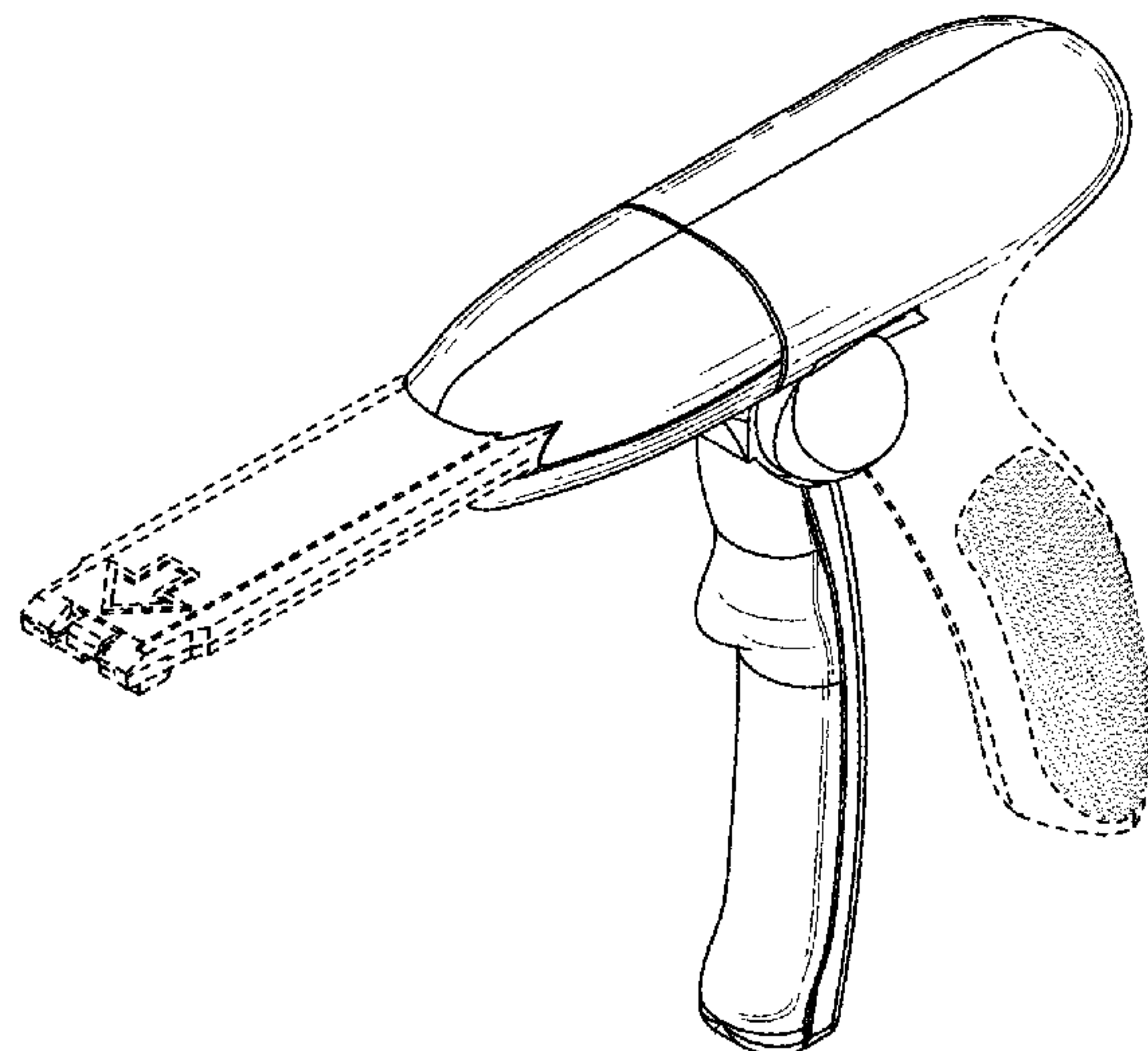
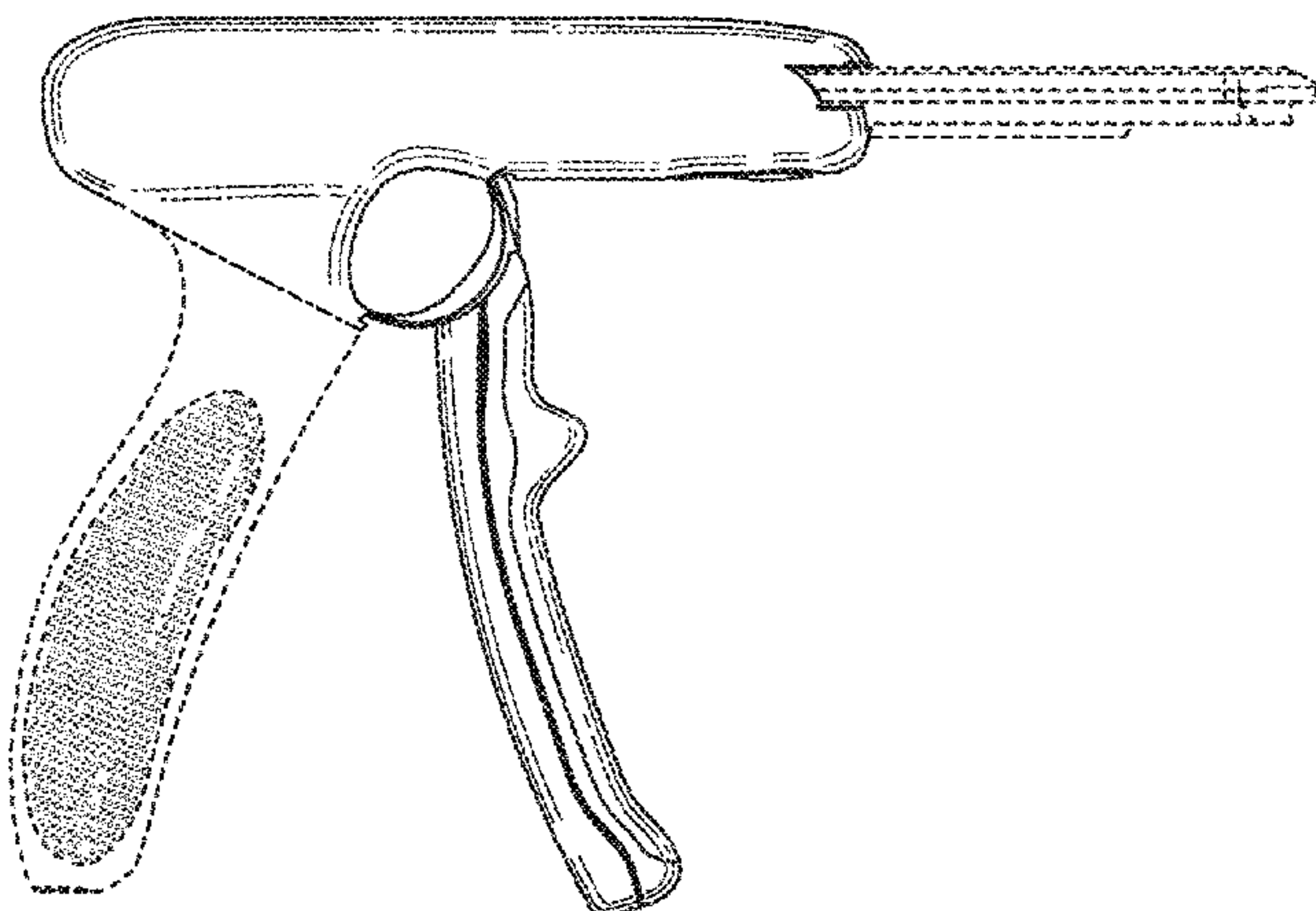
The ornamental design for a skin stapler, as shown and described.

**DESCRIPTION**

FIG. 1 is a right side elevation view of one skin stapler showing our new design;  
 FIG. 2 is a left side elevation view thereof;  
 FIG. 3 is a top plan view thereof;  
 FIG. 4 is a bottom plan view thereof;  
 FIG. 5 is a front elevation view thereof;  
 FIG. 6 is a rear elevation view thereof; and  
 FIG. 7 is a perspective view thereof;  
 FIG. 8 is a right side elevation view of another embodiment thereof, in a first position, showing my new design;  
 FIG. 9 is a left side elevation view thereof;  
 FIG. 10 is a top plan view thereof;  
 FIG. 11 is a bottom plan view thereof; and,  
 FIG. 12 is a perspective view thereof.

The dashed lines are included for the purpose of illustrating portions of the skin stapler that form no part of the claimed design. The dot-dash broken lines represent the bounds of the claimed design and form no part of the claimed design.

**1 Claim, 9 Drawing Sheets**



(56)

**References Cited**

## U.S. PATENT DOCUMENTS

5,665,097 A \* 9/1997 Baker ..... A61B 17/128  
227/901  
5,830,221 A \* 11/1998 Stein ..... A61B 17/068  
227/901  
D502,994 S \* 3/2005 Blake, III ..... D24/145  
8,636,188 B2 \* 1/2014 Buessler ..... A61B 17/0643  
227/175.1  
8,789,736 B2 \* 7/2014 Dudai ..... A61B 17/068  
227/120

## OTHER PUBLICATIONS

“Medline Catalog”, Apose Skin Stapler by Covidien; Medline Catalog; <http://www.medline.com/catalog/catalog.jsp>; Unknown Publication date but believed to be prior to present application filing date.

“Medline Catalog”, Disposable Skin Stapler by Covidien; Medline Catalog; <http://www.medline.com/catalog/catalog.jsp>; Unknown Publication date but believed to be prior to present application filing date.

“Medline Catalog”, Disposable Surgical Skin Stapler; Medline Catalog; <http://www.medline.com/catalog/catalog.jsp>; Unknown Publication date but believed to be prior to present application filing date.

“Medline Catalog”, Echelon Flex Powered Stapler; Johnson & Johnson; Medline Catalog; <http://www.medline.com/catalog/catalog.jsp>; Unknown Publication date but believed to be prior to present application filing date.

“Medline Catalog”, Endo GIA Ultra Universal Short Stapler by Covidien; Medline Catalog; <http://www.medline.com/catalog/catalog.jsp>; Unknown Publication date but believed to be prior to present application filing date.

“Medline Catalog”, Endo GIA Universal Stapler by Covidien; Medline Catalog; <http://www.medline.com/catalog/catalog.jsp>; Unknown Publication date but believed to be prior to present application filing date.

“Medline Catalog”, INSORB Absorbable Stapler by Incisive Surgical; Medline Catalog; <http://www.medline.com/catalog/catalog.jsp>; Unknown Publication date but believed to be prior to present application filing date.

“Medline Catalog”, MultiFire Premium Single Use Skin Stapler; Medline Catalog; <http://www.medline.com/catalog/catalog.jsp>; Unknown Publication date but believed to be prior to present application filing date.

“Medline Catalog”, PGX Disposable Skin Stapler PGX-15W by 3M; Medline Catalog; <http://www.medline.com/catalog/catalog.jsp>; Unknown Publication date but believed to be prior to present application filing date.

“Medline Catalog”, Precise Multi-Shot DS Disposable Skin Stapler by 3M Healthcare; Medline Catalog; <http://www.medline.com/catalog/catalog.jsp>; Unknown Publication date but believed to be prior to present application filing date.

“Medline Catalog”, Precise PGX Skin Stapler by 3M Healthcare; Medline Catalog; <http://www.medline.com/catalog/catalog.jsp>; Unknown Publication date but believed to be prior to present application filing date.

“Medline Catalog”, Precise Vista Disposable Skin Stapler 3997 by 3M Healthcare; Medline Catalog; <http://www.medline.com/catalog/catalog.jsp>; Unknown Publication date but believed to be prior to present application filing date.

“Medline Catalog”, Precise Vista Disposable Skin Stapler by 3M Healthcare; Medline Catalog; <http://www.medline.com/catalog/catalog.jsp>; Unknown Publication date but believed to be prior to present application filing date.

“Medline Catalog”, Proximate Skin Staplers by Ethicon; Medline Catalog; <http://www.medline.com/catalog/catalog.jsp>; Unknown Publication date but believed to be prior to present application filing date.

“Medline Catalog”, Reflex Skin Staplers by Conmed; Medline Catalog; <http://www.medline.com/catalog/catalog.jsp>; Unknown Publication date but believed to be prior to present application filing date.

“Medline Catalog”, Rotating Head Skin Staplers by DeRoyal; Medline Catalog; <http://www.medline.com/catalog/catalog.jsp>; Unknown Publication date but believed to be prior to present application filing date.

“Medline Catalog”, Reticulatur 55 Poly Stapler by Covidien; Medline Catalog; <http://www.medline.com/catalog/catalog.jsp>; Unknown Publication date but believed to be prior to present application filing date.

“Medline Catalog”, Signet Disposable Skin Stapler by Covidien; Medline Catalog; <http://www.medline.com/catalog/catalog.jsp>; Unknown Publication date but believed to be prior to present application filing date.

“Medline Catalog”, Skin Staplers by DeRoyal; Medline Catalog; <http://www.medline.com/catalog/catalog.jsp>; Unknown Publication date but believed to be prior to present application filing date.

“Medline Catalog”, Stapler Skin 35 Count, STRL; Medline Catalog; <http://www.medline.com/catalog/catalog.jsp>; Unknown Publication date but believed to be prior to present application filing date.

“Medline Catalog”, Weck Disposable Skin Staplers by Teleflex; Medline Catalog; <http://www.medline.com/catalog/catalog.jsp>; Unknown Publication date but believed to be prior to present application filing date.

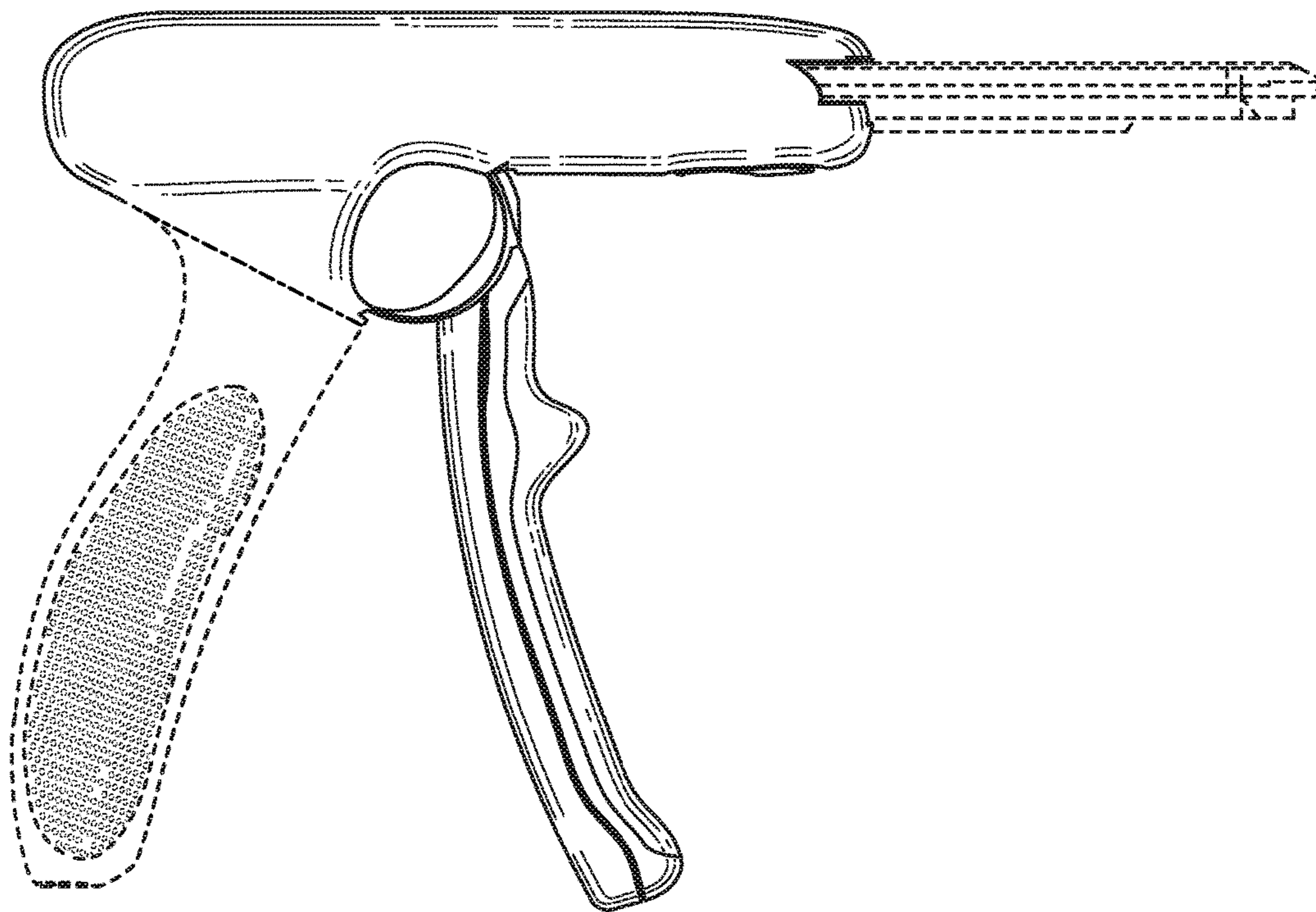
“Medline Catalog”, Weck Rotating Head Stapler by Teleflex M; Medline Catalog; <http://www.medline.com/catalog/catalog.jsp>; Unknown Publication date but believed to be prior to present application filing date.

“Medline Product Catalog”, Endo Gia Ultra Universal Stapler by Covidien; Medline Catalog; <http://www.medline.com/catalog/catalog.jsp>; Unknown Publication date but believed to be prior to present application filing date.

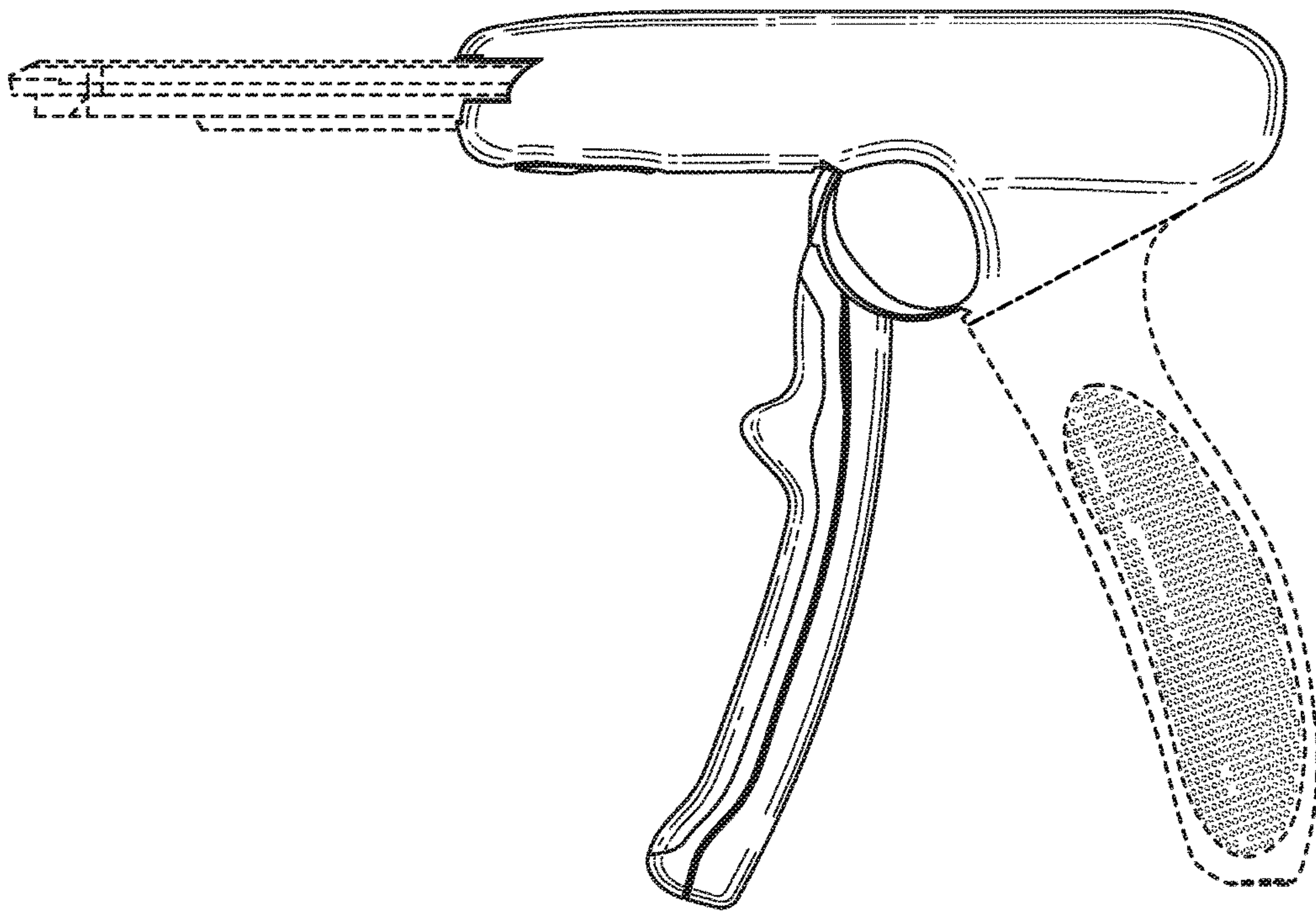
Booker, Mark, “NonFinal OA”, U.S. Appl. No. 29/503,564, filed Sep. 26, 2014; dated Oct. 6, 2015.

\* cited by examiner

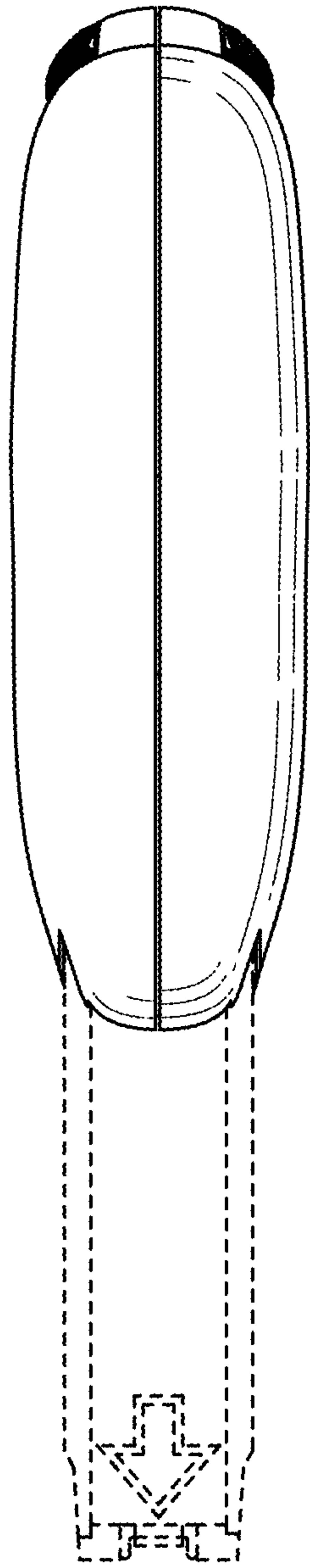




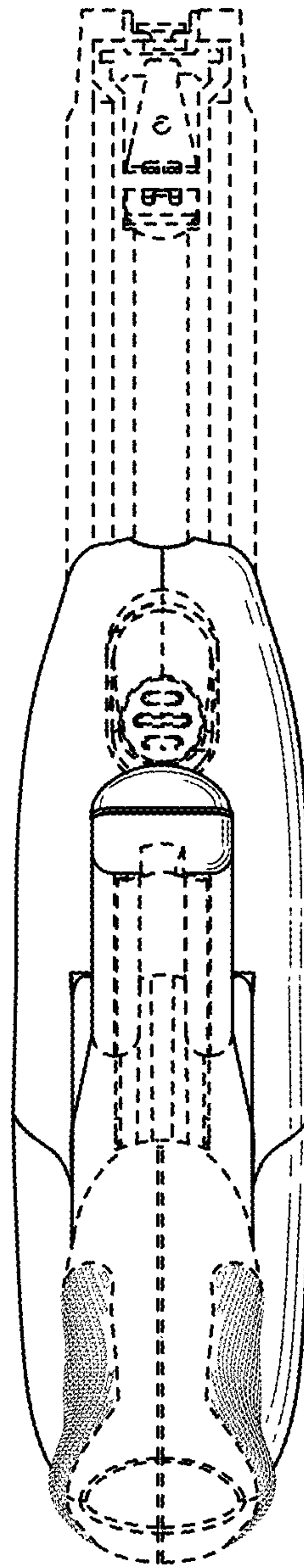
***FIG. 1***



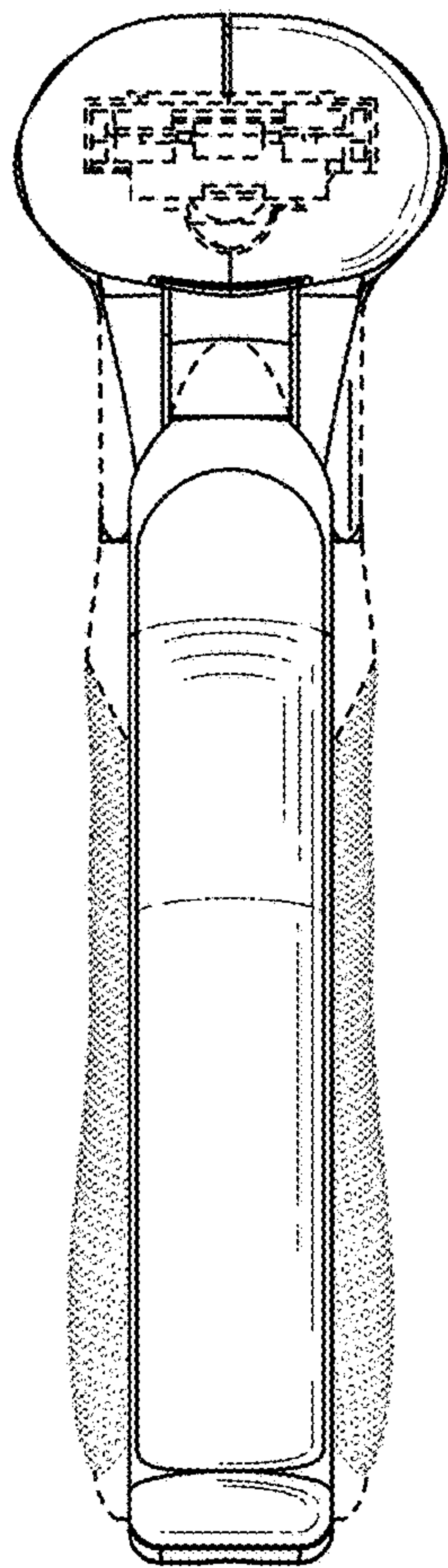
***FIG. 2***



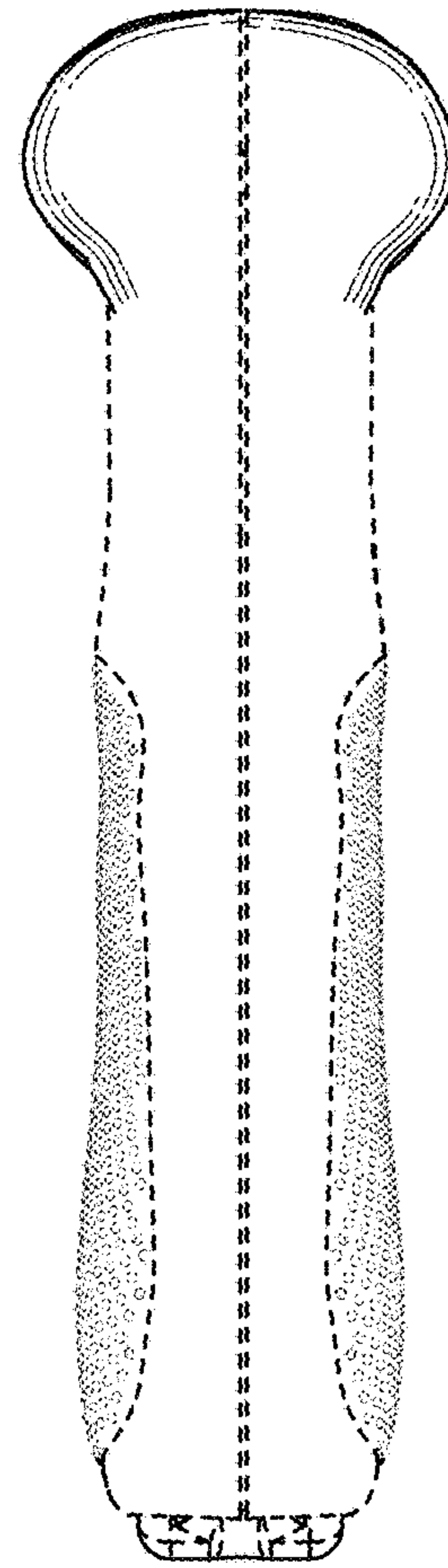
**FIG. 3**



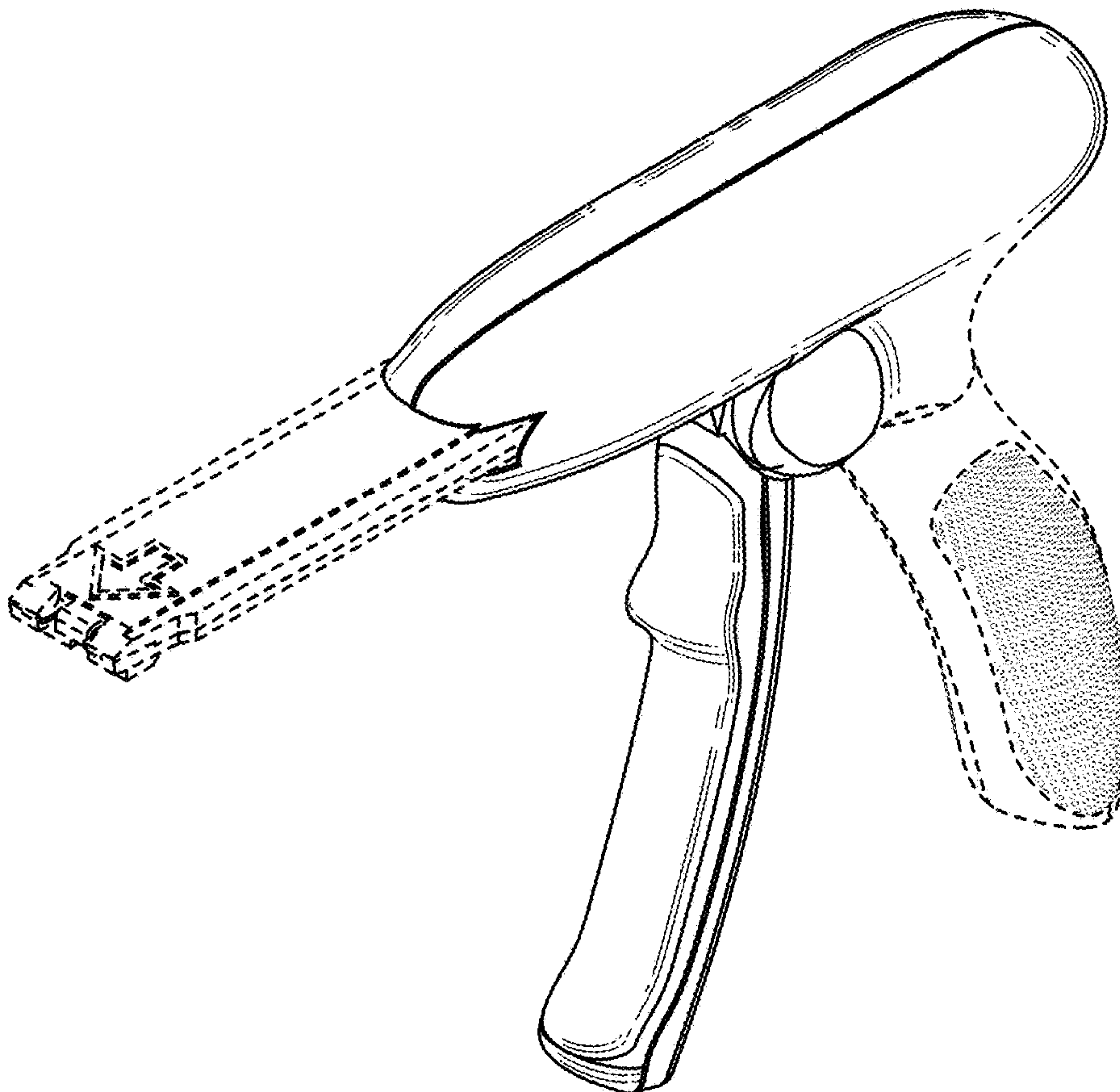
**FIG. 4**



**FIG. 5**

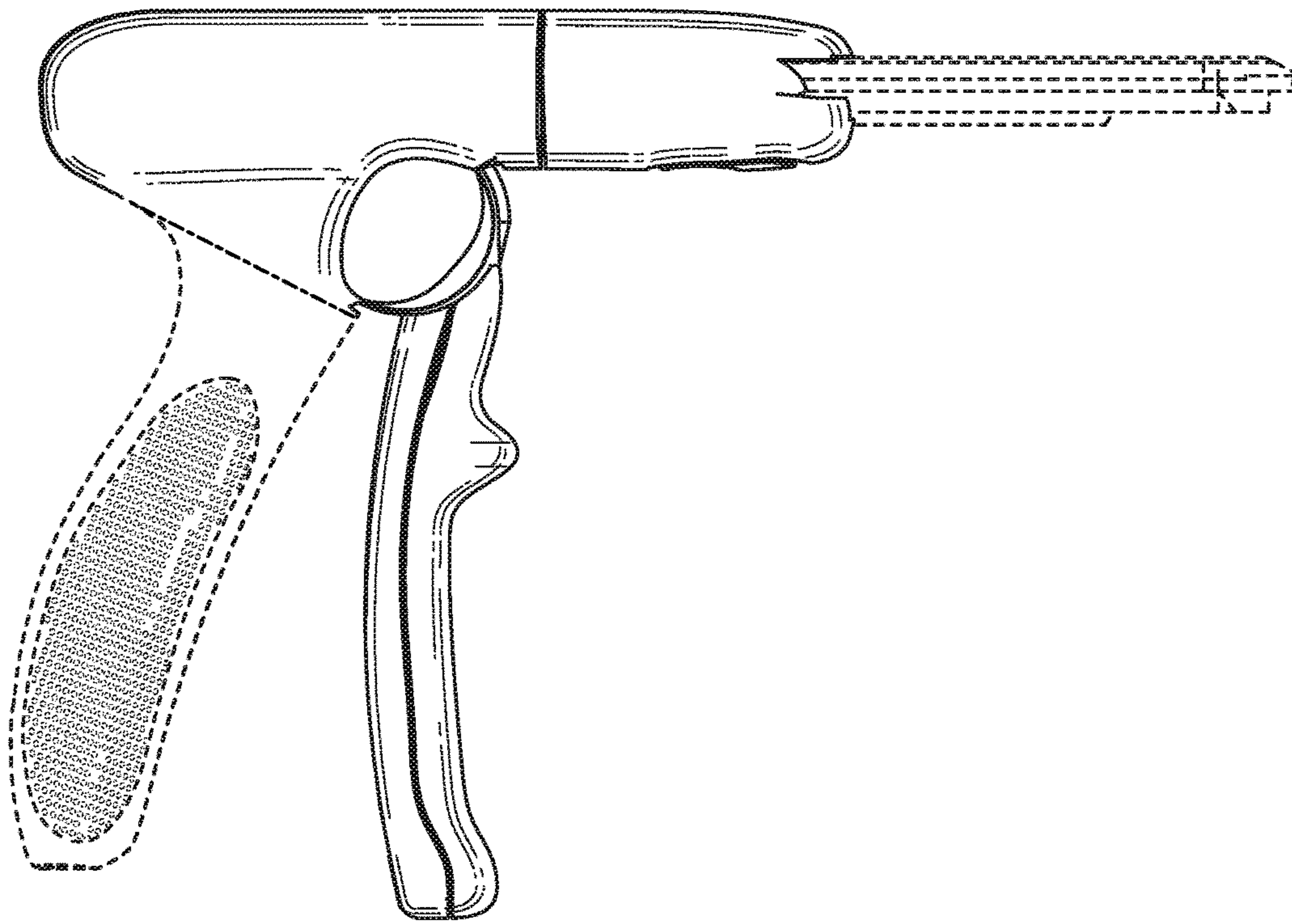


**FIG. 6**



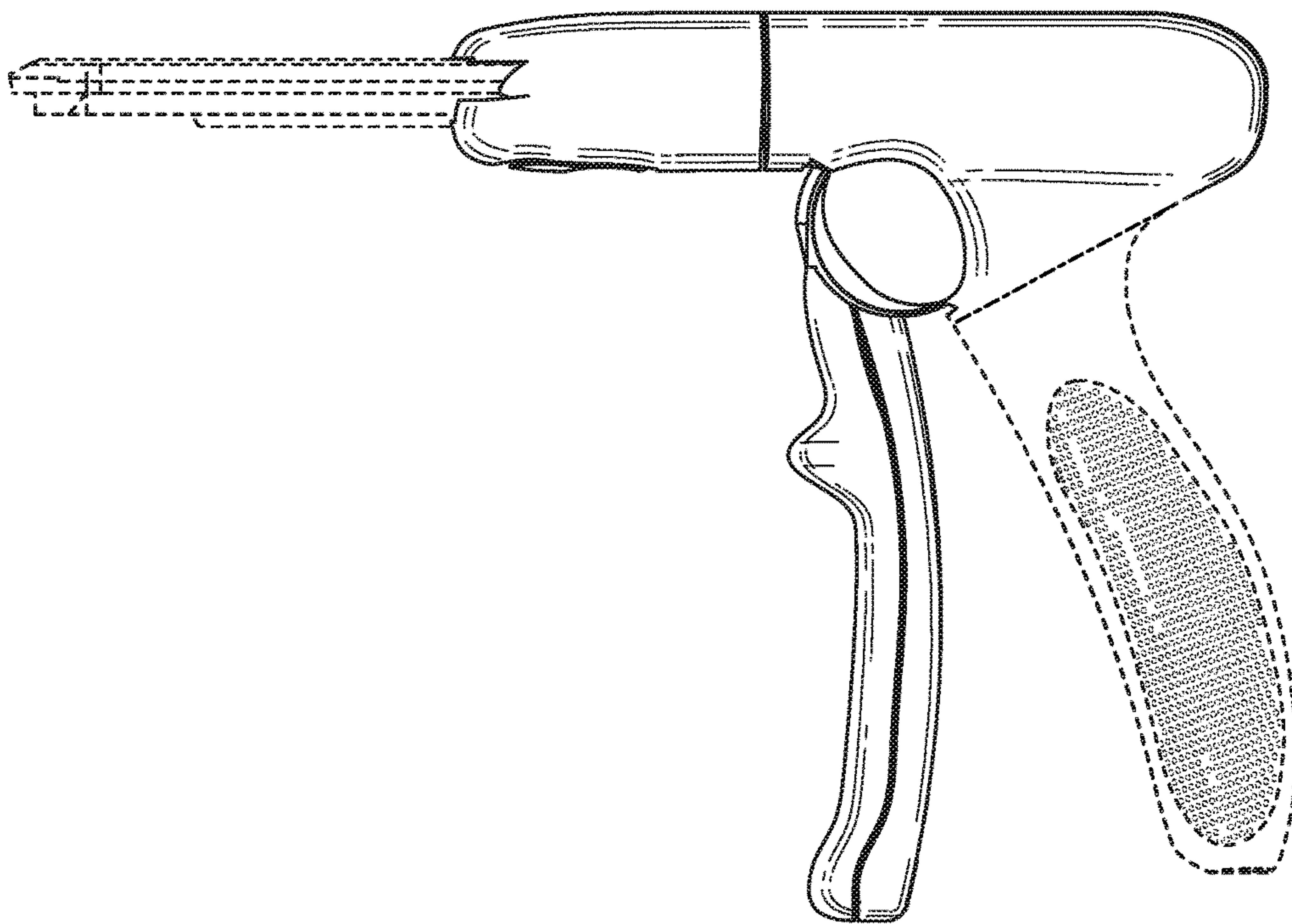
**FIG. 7**



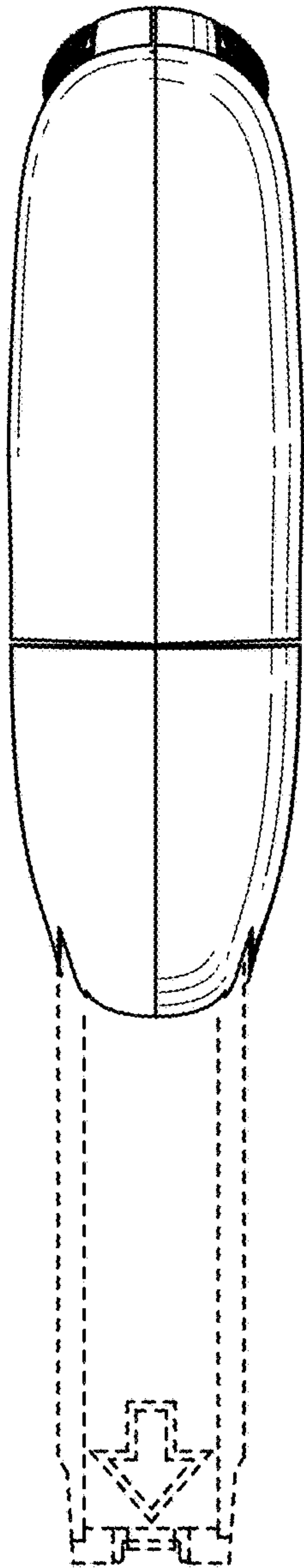


**FIG. 8**

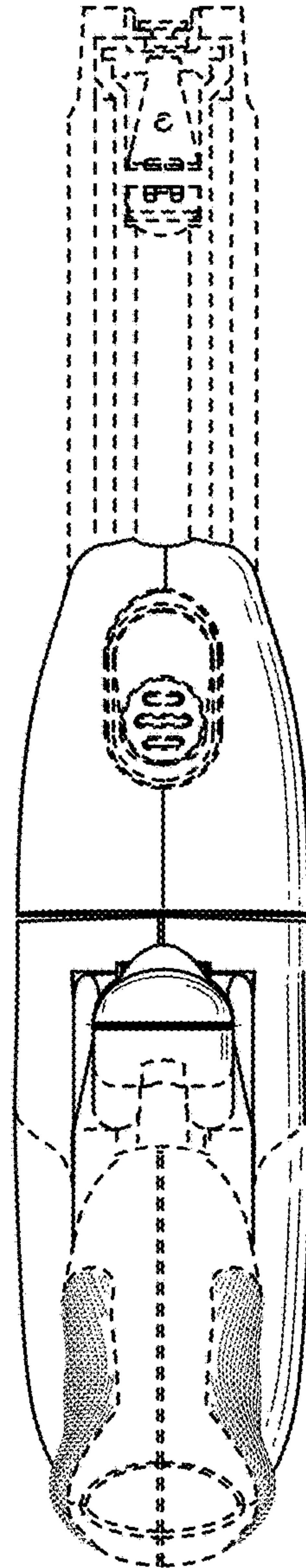




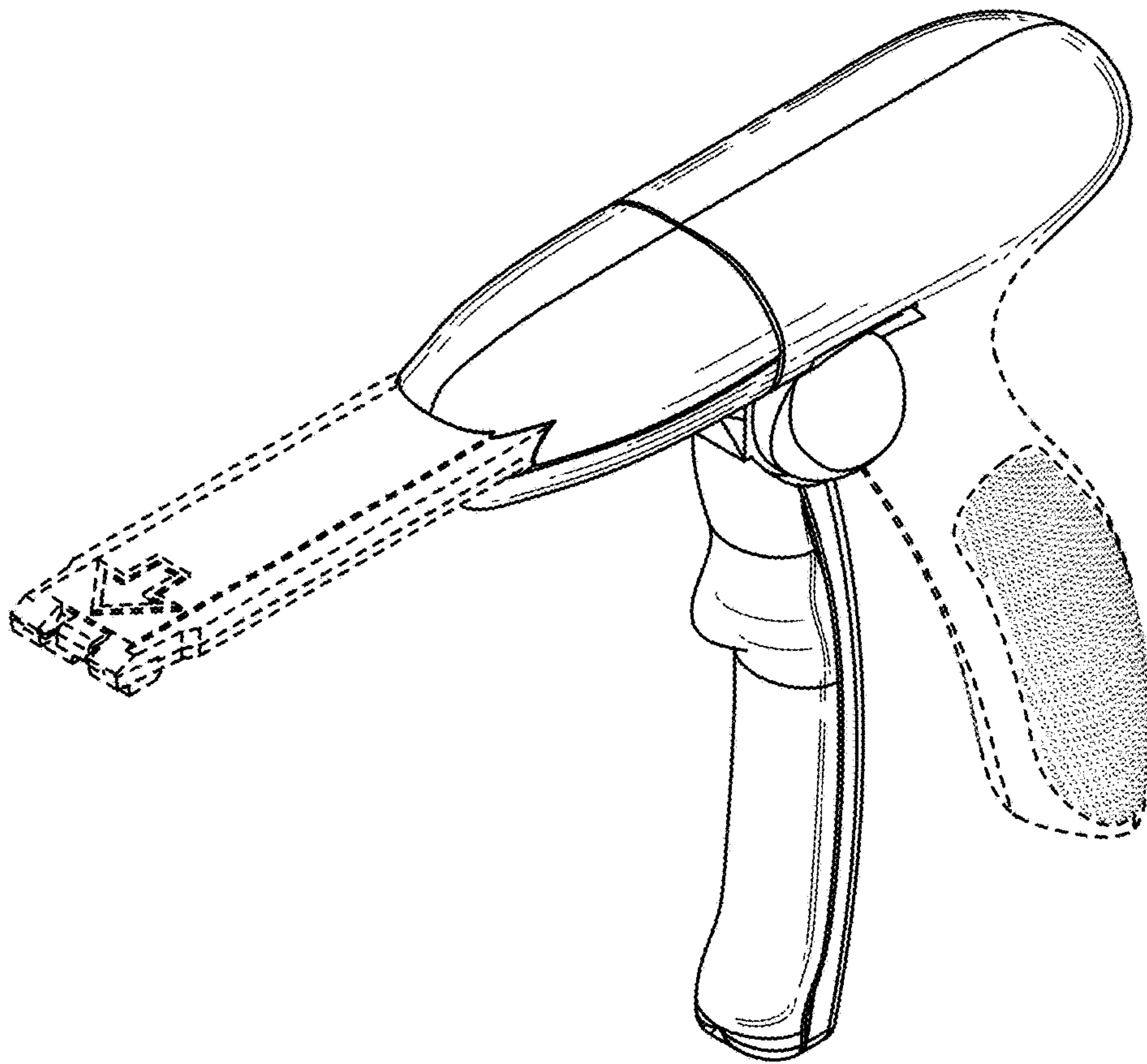
**FIG. 9**



**FIG. 10**



**FIG. 11**



***FIG. 12***