



US00D810250S

(12) **United States Design Patent** (10) **Patent No.:** **US D810,250 S**  
**Yoshioka et al.** (45) **Date of Patent:** **\*\* Feb. 13, 2018**

(54) **WATER CLOSET**  
(71) Applicant: **TOTO, Ltd.**, Kitakyushu-shi, Fukuoka (JP)  
(72) Inventors: **Yuji Yoshioka**, Kitakyushu (JP); **Hiroataka Nakabayashi**, Kitakyushu (JP); **Minoru Tani**, Kitakyushu (JP)  
(73) Assignee: **TOTO, Ltd.**, Kitakyushu-shi, Fukuoka (JP)  
(\*\*) Term: **15 Years**  
(21) Appl. No.: **29/577,097**  
(22) Filed: **Sep. 9, 2016**  
(30) **Foreign Application Priority Data**

Mar. 29, 2016 (JP) ..... 2016-006778  
(51) **LOC (11) Cl.** ..... **23-02**  
(52) **U.S. Cl.**  
USPC ..... **D23/295**  
(58) **Field of Classification Search**  
USPC ..... D23/295-303, 307, 309, 310, 313  
CPC ..... E03D 11/08; E03D 11/18; E03D 5/10;  
E03D 13/00; A47K 11/00; A47K 13/00;  
Y10S 4/05  
See application file for complete search history.

(56) **References Cited**  
U.S. PATENT DOCUMENTS  
D485,604 S \* 1/2004 Good ..... D23/295  
D537,151 S \* 2/2007 Good ..... D23/295  
D579,533 S \* 10/2008 Cornille ..... D23/295

D604,812 S \* 11/2009 Kuang ..... D23/295  
D610,241 S \* 2/2010 Giovannoni ..... D23/295  
D614,751 S \* 4/2010 Ogawa ..... D23/295  
D639,407 S \* 6/2011 Kang ..... D23/300  
D642,247 S \* 7/2011 Jiang ..... D23/295  
D651,297 S \* 12/2011 Jiang ..... D23/309  
D651,299 S \* 12/2011 Jiang ..... D23/311  
D663,391 S \* 7/2012 Iranyi ..... D23/295  
D743,011 S \* 11/2015 Woodside ..... D23/299  
D766,405 S \* 9/2016 Flowers ..... D23/300

\* cited by examiner  
*Primary Examiner* — Lakiya G Rogers  
*Assistant Examiner* — John A Voytek  
(74) *Attorney, Agent, or Firm* — Banner & Witcoff, Ltd.

(57) **CLAIM**  
The ornamental design for a water closet, as shown and described.

**DESCRIPTION**  
FIG. 1 is a perspective view of a water closet showing our new design;  
FIG. 2 is a front view thereof;  
FIG. 3 is a rear view thereof;  
FIG. 4 is a left side view thereof;  
FIG. 5 is a right side view thereof;  
FIG. 6 is a top view thereof; and,  
FIG. 7 is a bottom view thereof.  
The broken lines in the figures are included for the purpose of illustrating the unclaimed portions of the water closet and form no part of the claimed design.  
The dash-dot-dash broken lines in the figures represent an unclaimed boundary between claimed and unclaimed subject matter.

**1 Claim, 4 Drawing Sheets**

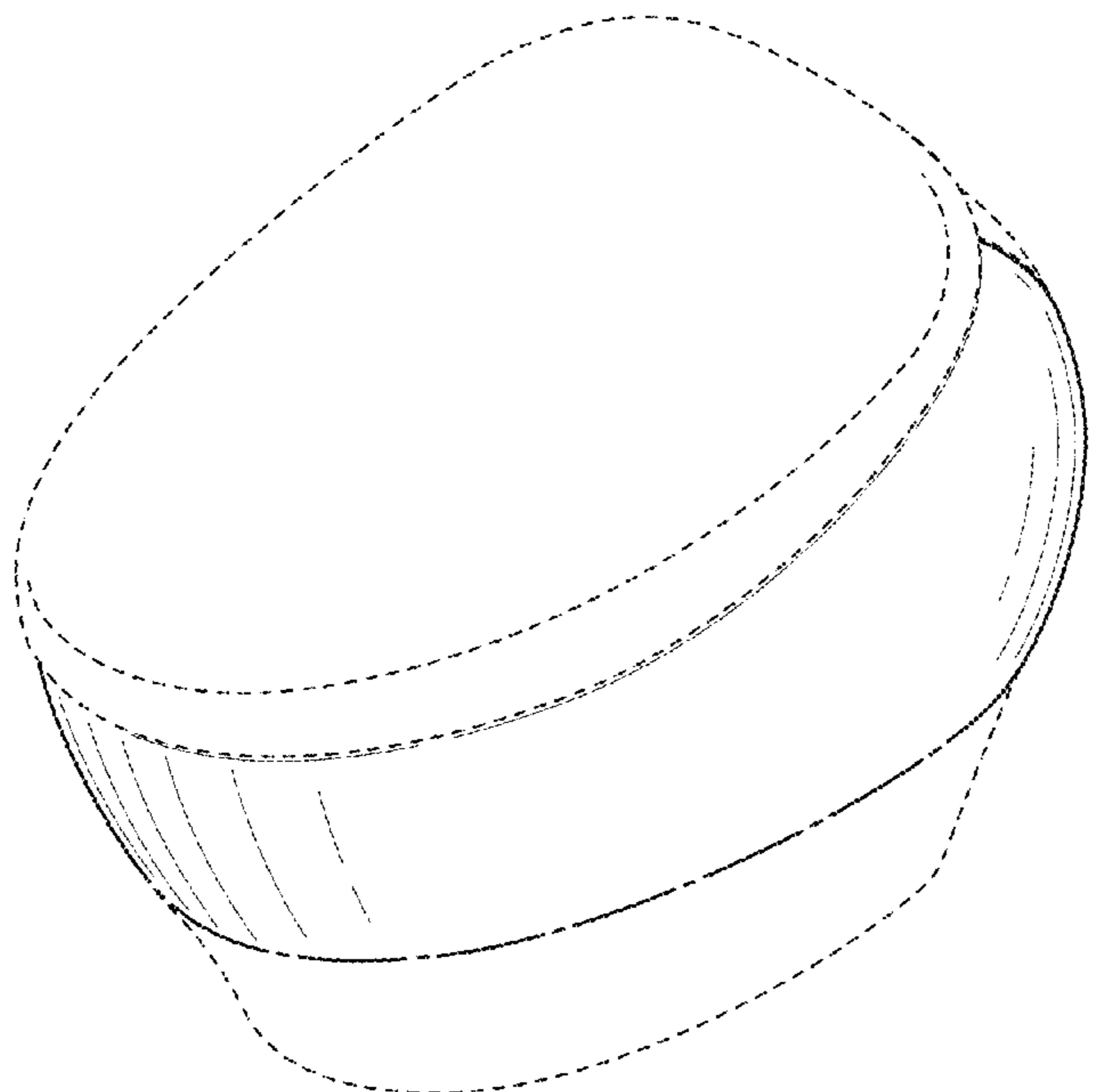

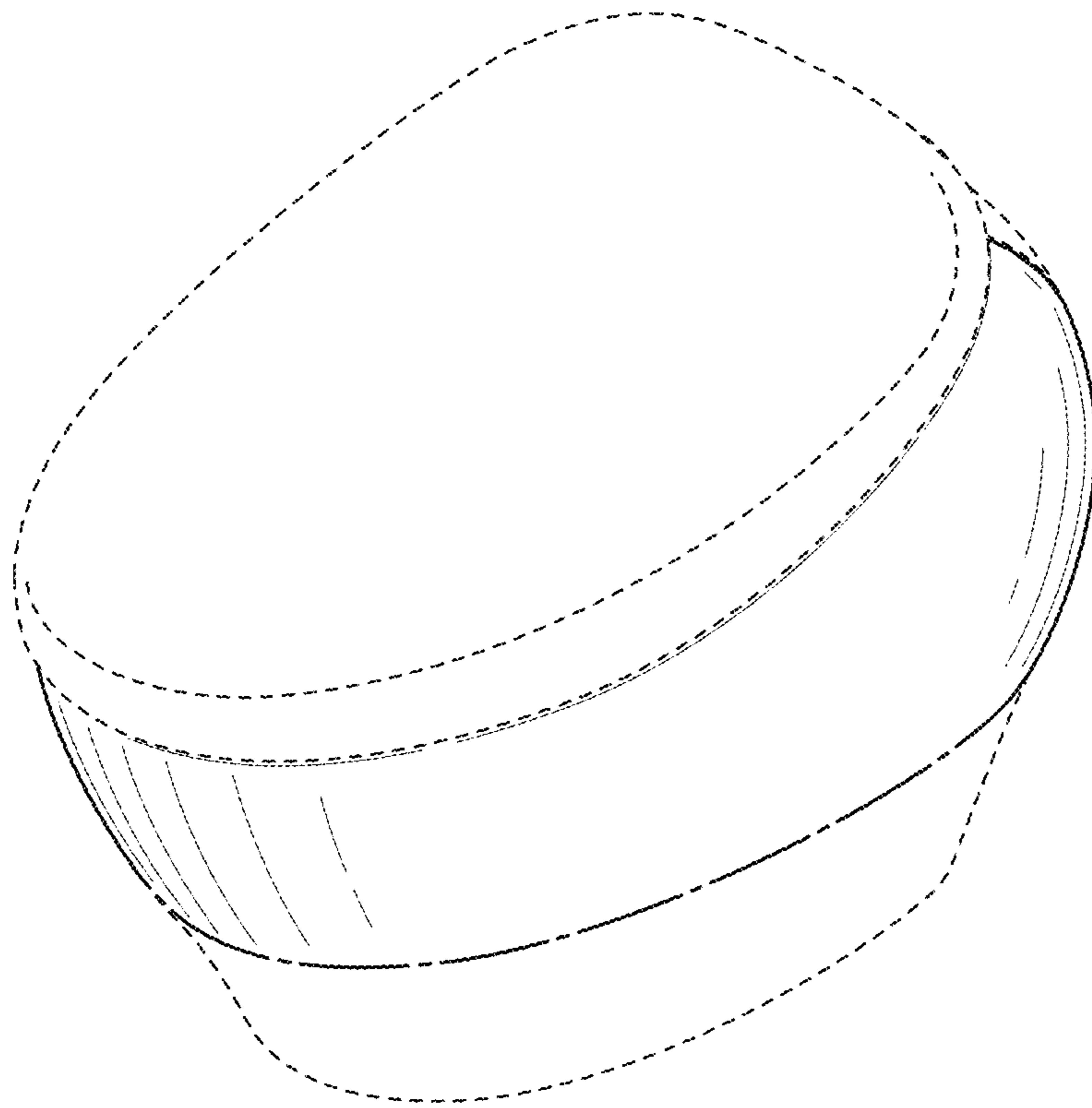

*FIG. 1*

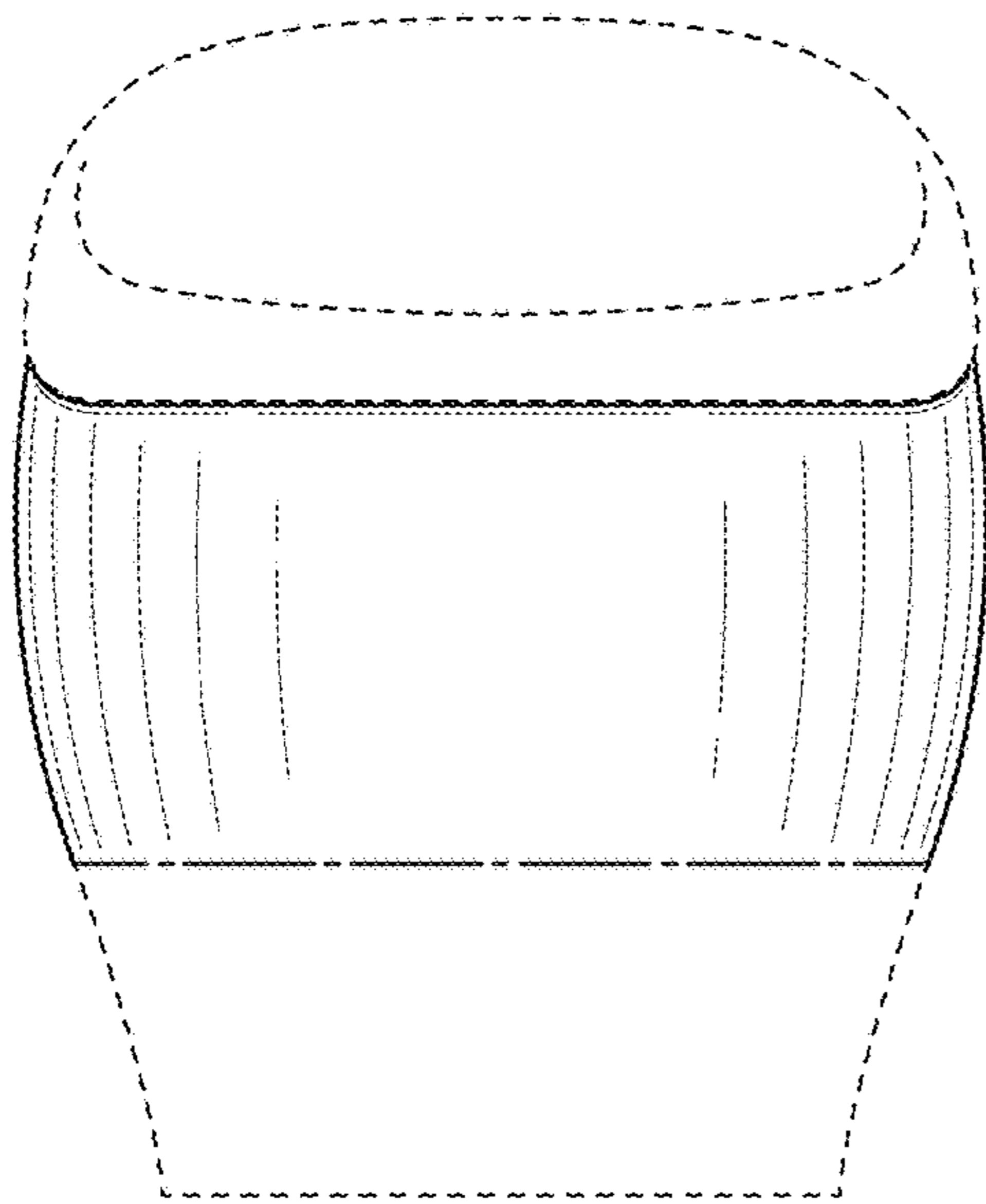

FIG. 2

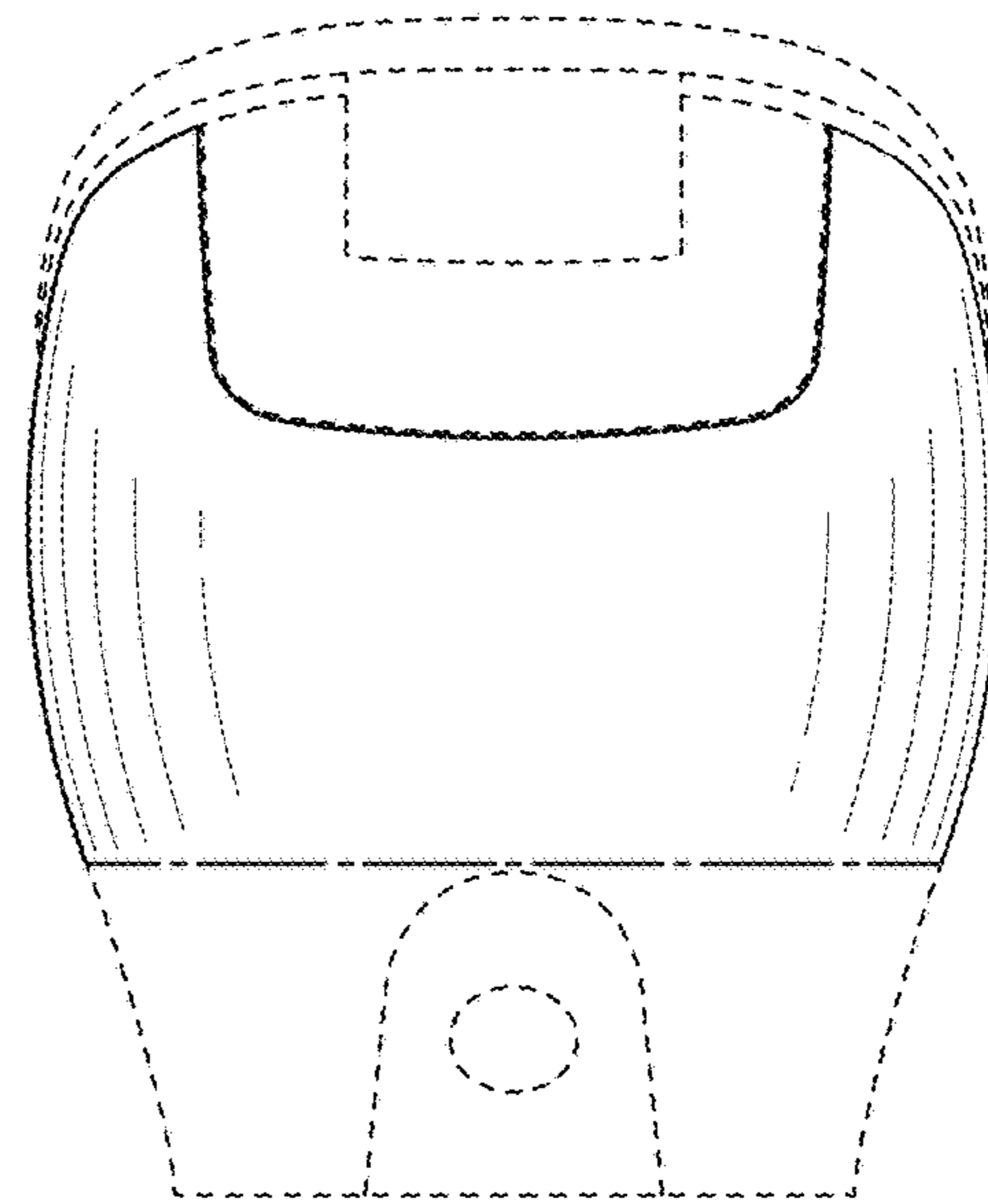

FIG. 3

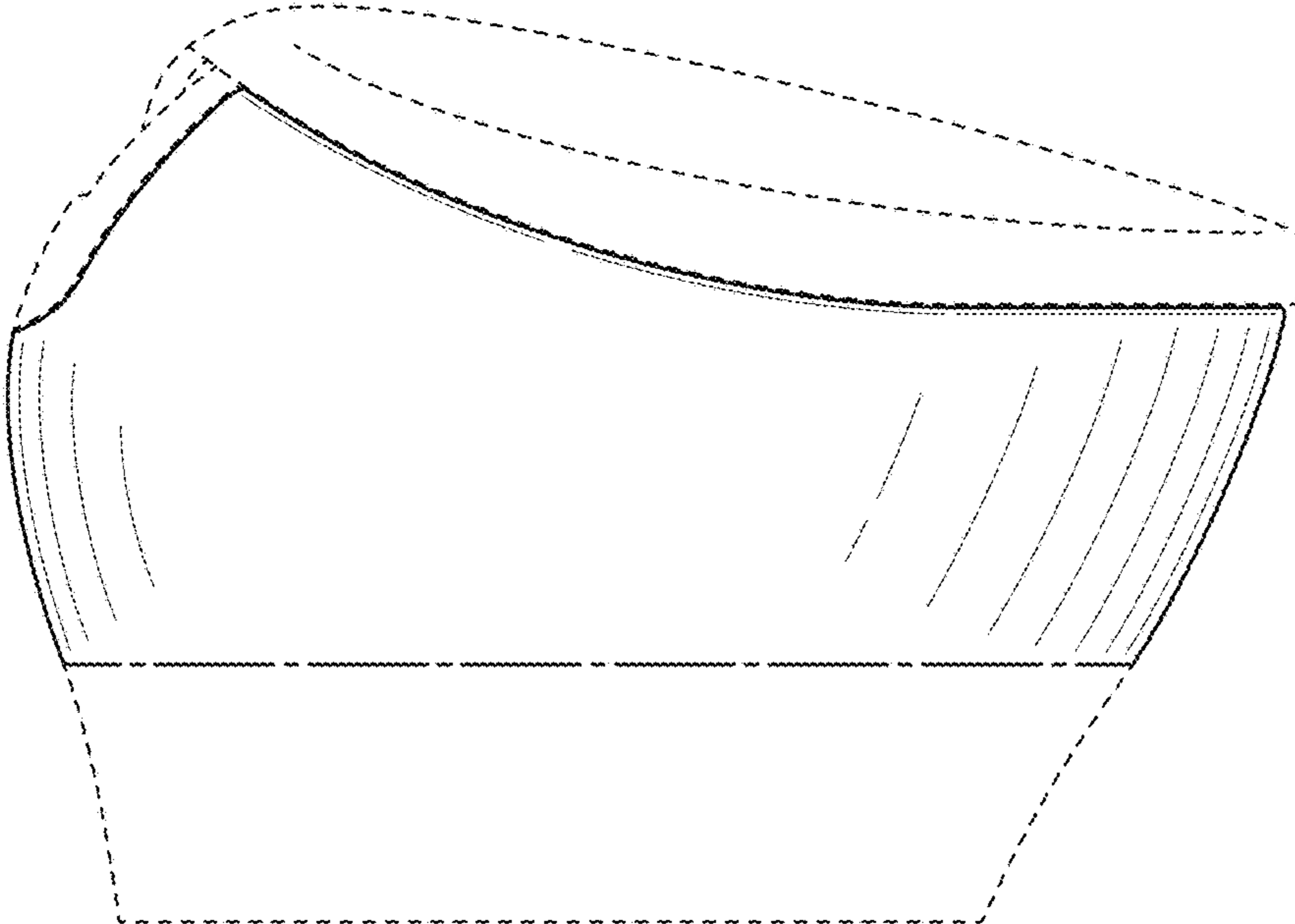

FIG. 4

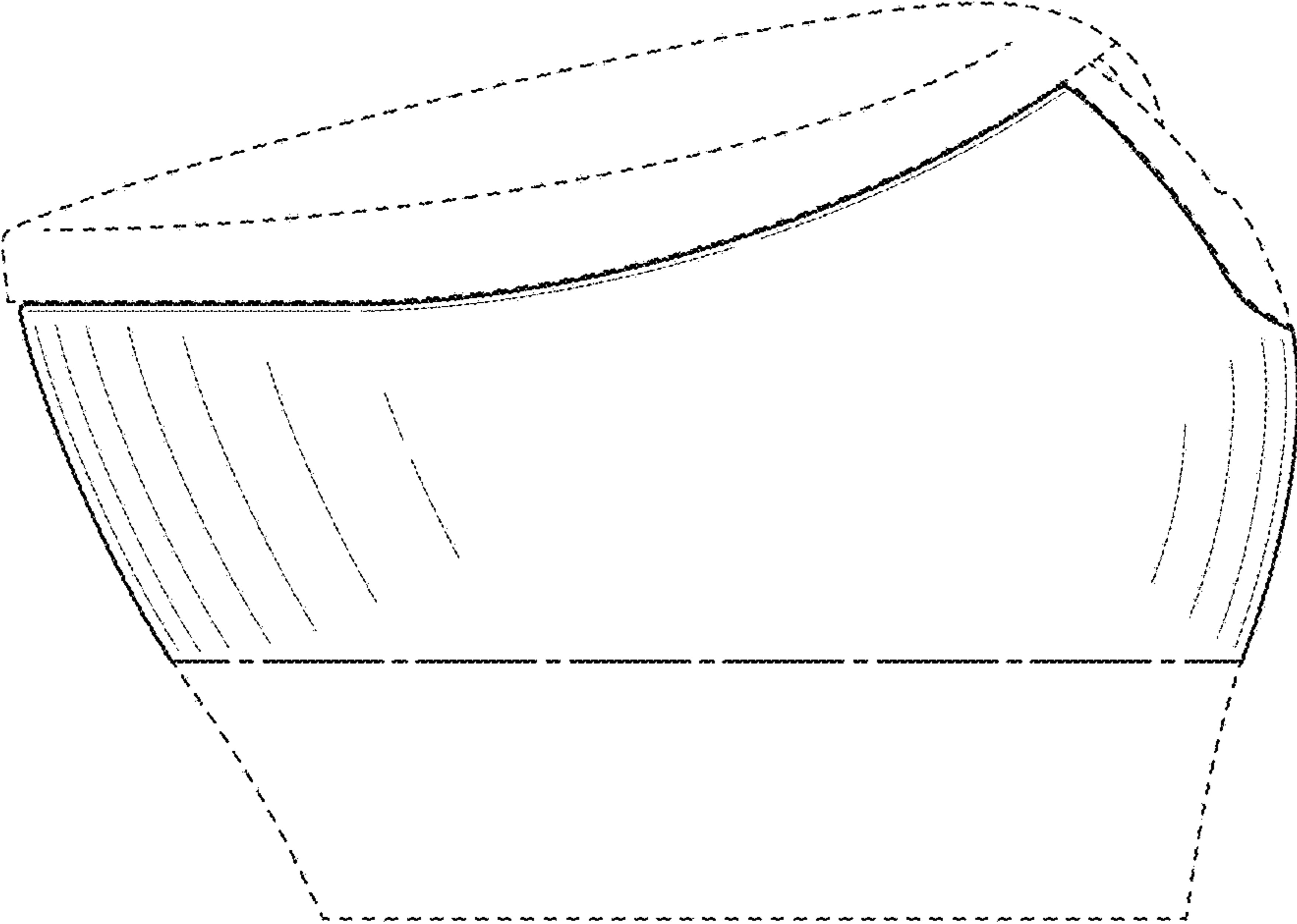

FIG. 5

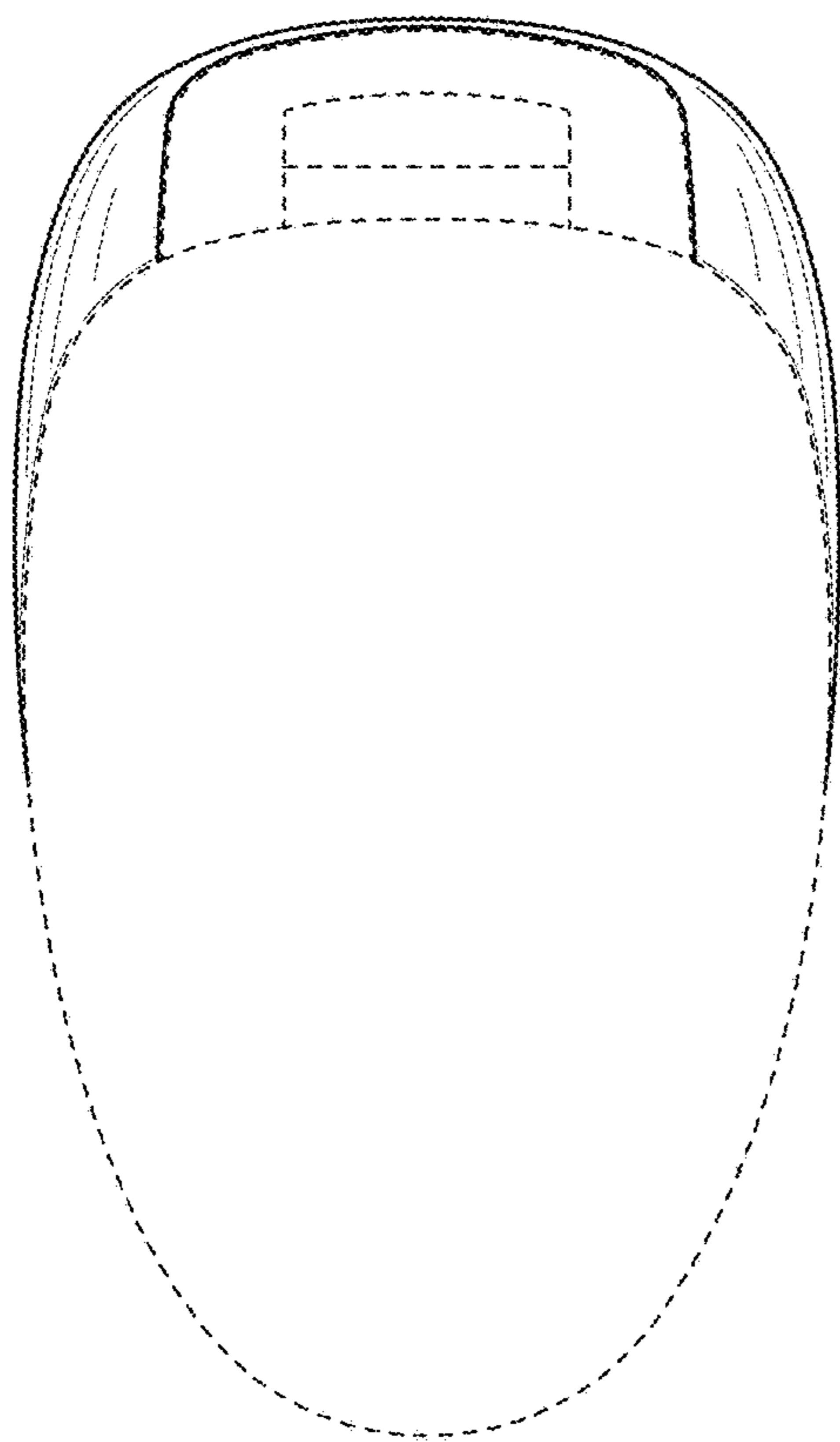

FIG. 6

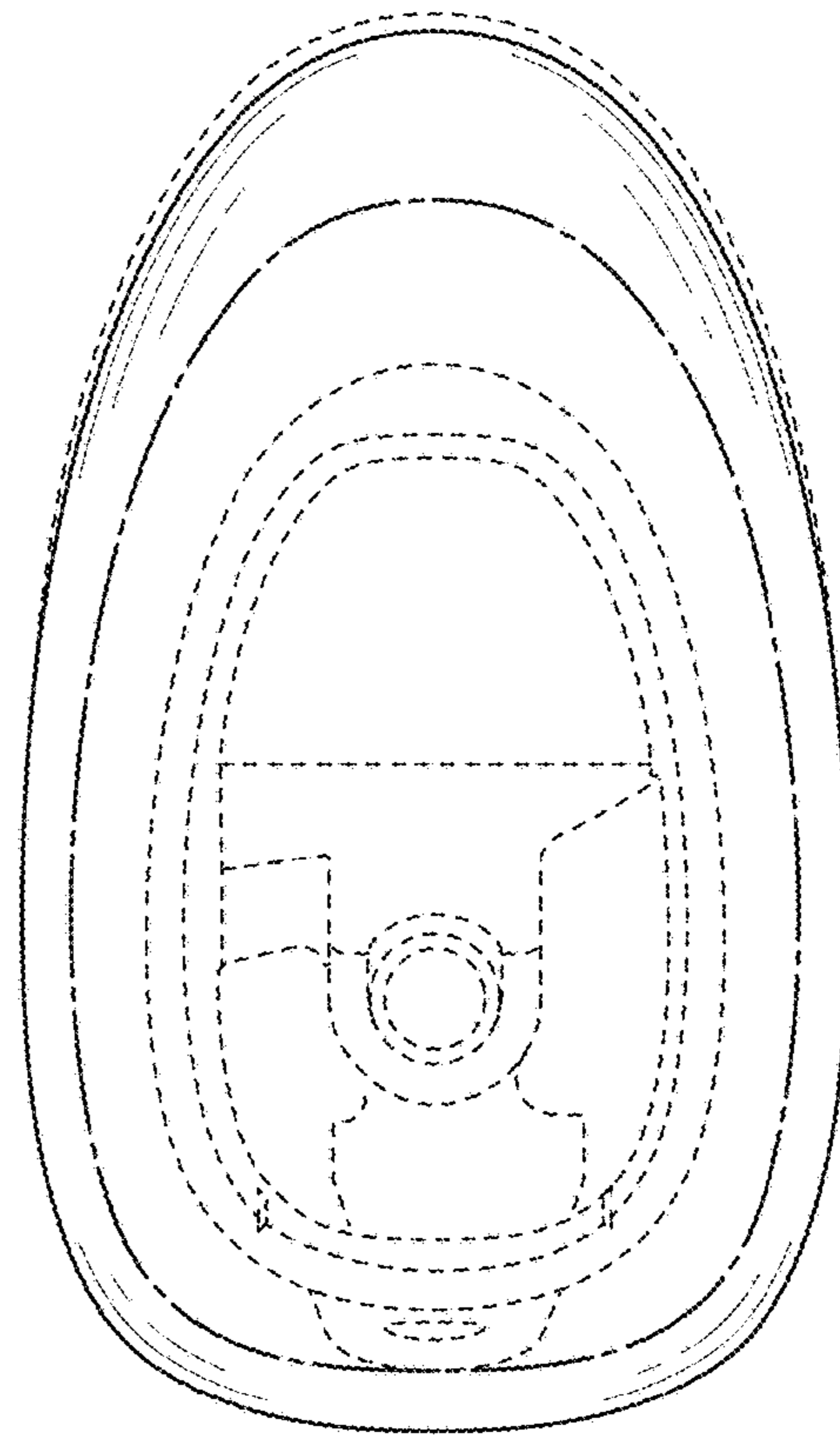

FIG. 7