



US00D810198S

(12) **United States Design Patent**  
**Azar**

(10) **Patent No.: US D810,198 S**

(45) **Date of Patent: \*\* Feb. 13, 2018**

(54) **ROLL FILE**

(71) Applicant: **IDesign Corporation**, Leesburg, VA  
(US)

(72) Inventor: **Samin Azar**, Leesburg, VA (US)

(73) Assignee: **IDesign Corporation**, Leesburg, VA  
(US)

(\*\*) Term: **15 Years**

(21) Appl. No.: **29/579,567**

(22) Filed: **Sep. 30, 2016**

(51) **LOC (11) Cl.** ..... **19-02**

(52) **U.S. Cl.**  
USPC ..... **D19/90**

(58) **Field of Classification Search**  
USPC ..... D6/512-514, 552-553, 566, 567, 570,  
D6/598, 651.1, 675, 675.4, 683, 683.1,  
D6/705; D9/432; D19/26-31, 75, 77,  
D19/85-92; D3/304  
CPC ..... A47B 63/00; A47B 23/044; A47B 47/02;  
A47B 55/00; A47B 55/02; A47B 87/007;  
A47B 87/02; B42F 7/145; B42F 17/12  
See application file for complete search history.

(56) **References Cited**

**U.S. PATENT DOCUMENTS**

702,531 A *	6/1902	Bowen	.....	A47K 5/05
				118/76
D39,437 S *	8/1908	McIntyre	.....	211/69.9
3,158,524 A *	11/1964	Tong	.....	A41G 1/00
				206/423
D218,341 S *	8/1970	Giannotti	.....	D11/147
D226,614 S *	4/1973	Stauffer	.....	D11/158
D244,013 S *	4/1977	Perkins	.....	428/11
D262,121 S *	12/1981	Brady	.....	D11/158
D264,364 S *	5/1982	Pazurek	.....	D21/713
D276,246 S *	11/1984	von Lienen	.....	D21/371

4,532,722 A *	8/1985	Sax	.....	D06F 58/203
				206/0.5
D282,737 S *	2/1986	Huang	.....	D14/143
D287,988 S *	1/1987	Billinghurst	.....	D21/468
D292,991 S *	12/1987	Adler	.....	D19/78
D293,690 S *	1/1988	Adler	.....	D19/78
D324,545 S *	3/1992	Phillips	.....	D19/100
D325,934 S *	5/1992	Ramljak	.....	D11/147
D326,114 S *	5/1992	Murtagh	.....	D11/131
D336,110 S *	6/1993	Peersmann	.....	D19/69
D337,177 S *	7/1993	Tiramani	.....	D28/76
D353,064 S *	12/1994	Gilbert	.....	D1/105
D388,464 S *	12/1997	Najbart	.....	D19/78

(Continued)

*Primary Examiner* — Elizabeth Albert

(74) *Attorney, Agent, or Firm* — Design IP

(57) **CLAIM**

The ornamental design for a roll file, as shown and described.

**DESCRIPTION**

FIG. 1 is a front perspective view of a first embodiment of a roll file showing my new design;  
 FIG. 2 is a front view thereof;  
 FIG. 3 is a rear view thereof;  
 FIG. 4 is a left side view thereof;  
 FIG. 5 is a right side view thereof;  
 FIG. 6 is a top view thereof;  
 FIG. 7 is a bottom view thereof;  
 FIG. 8 is a front perspective view of a second embodiment of a roll file showing my new design;  
 FIG. 9 is a front view thereof;  
 FIG. 10 is a rear view thereof;  
 FIG. 11 is a left side view thereof;  
 FIG. 12 is a right side view thereof;  
 FIG. 13 is a top view thereof; and,  
 FIG. 14 is a bottom view thereof.  
 The broken lines in FIGS. 1 through 14 that define the bounds of the claimed design form no part thereof.

**1 Claim, 8 Drawing Sheets**

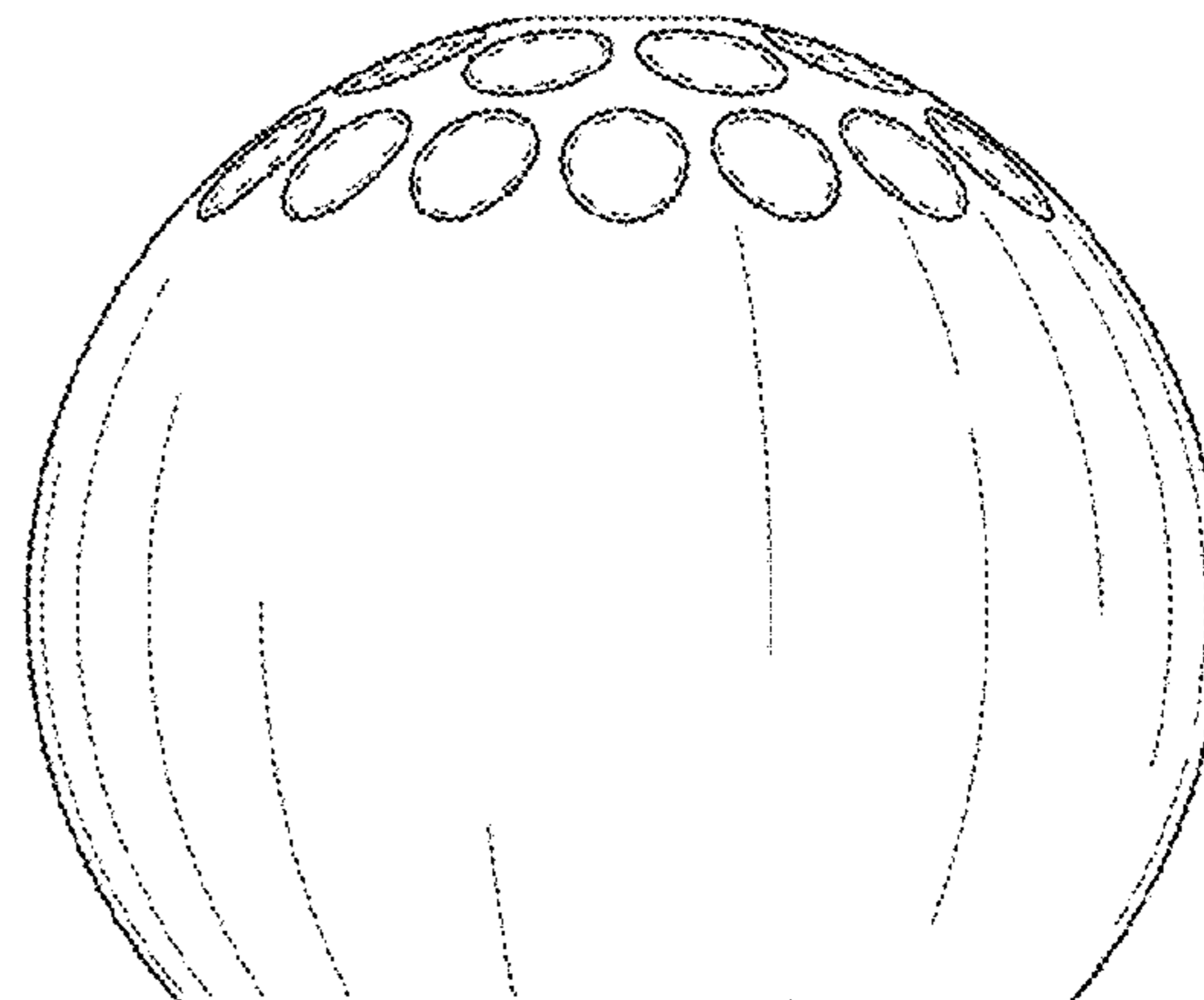
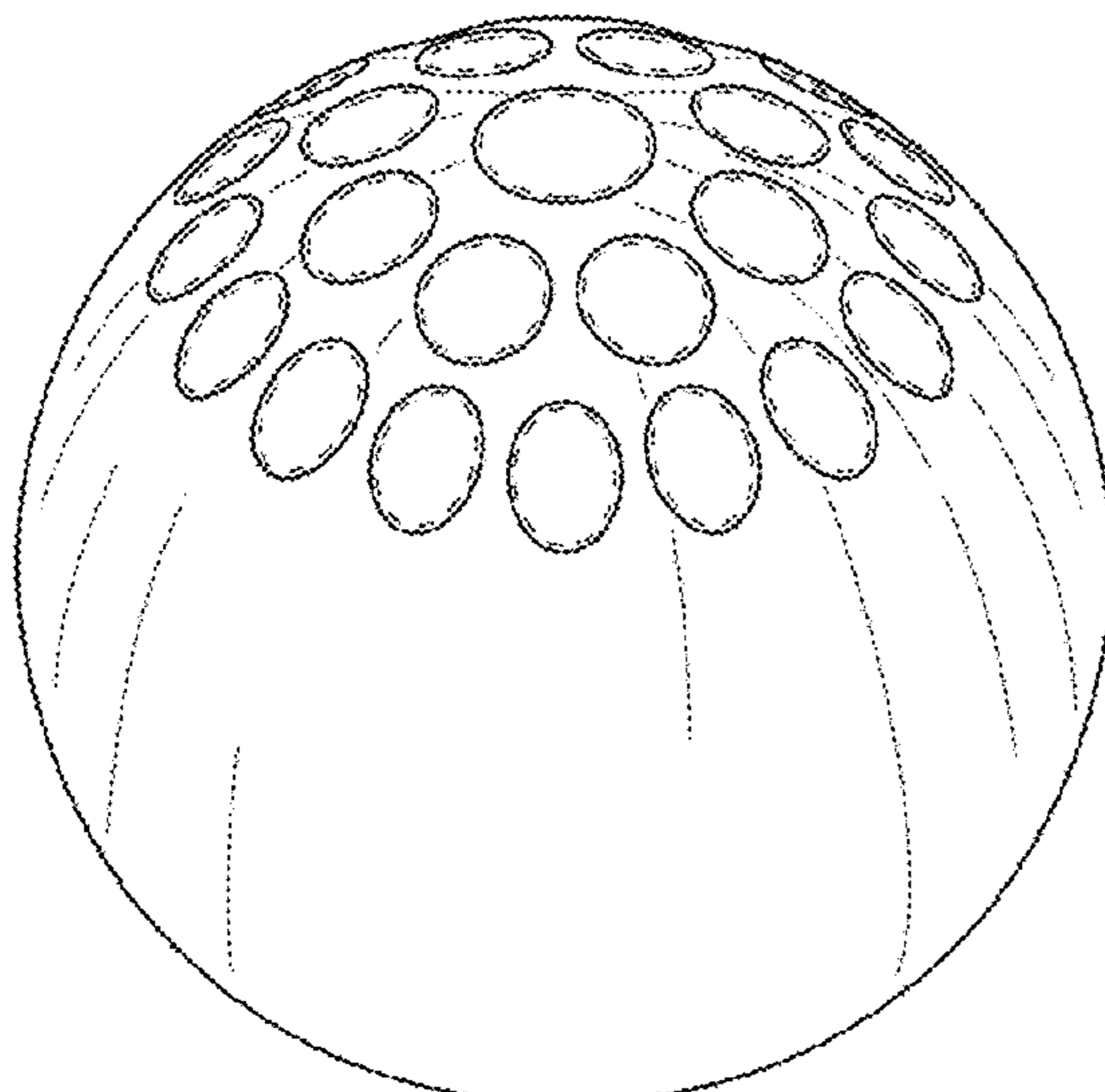

(56)

**References Cited**

U.S. PATENT DOCUMENTS

D390,499	S	*	2/1998	Durham	.....	D11/143
5,768,917	A	*	6/1998	Freida	.....	D06F 39/024
						206/0.5
D417,239	S	*	11/1999	Sullivan	.....	D19/82
D447,934	S	*	9/2001	Manor, III	.....	D8/367
D458,639	S	*	6/2002	Anderson	.....	D19/82
D460,168	S	*	7/2002	Chen	.....	D23/364
D497,037	S	*	10/2004	Rodriguez	.....	D28/82
D498,636	S	*	11/2004	Kuo	.....	D6/601
6,880,765	B2	*	4/2005	Tuomikoski	.....	A01M 31/008
						239/34
D536,081	S	*	1/2007	Steinel	.....	D23/366
D542,705	S	*	5/2007	Peterson	.....	D11/147
D547,492	S	*	7/2007	Caroen	.....	D28/8.1
D576,423	S	*	9/2008	Weldon	.....	D6/665
D577,388	S	*	9/2008	Lo	.....	D21/401
D579,163	S	*	10/2008	Schablinger	.....	D32/29.1
D586,397	S	*	2/2009	Farnworth	.....	D19/187
D599,958	S	*	9/2009	Washington	.....	D28/82
D612,473	S	*	3/2010	Valentino	.....	D23/366
D798,491	S	*	9/2017	Kelly	.....	D26/104

\* cited by examiner

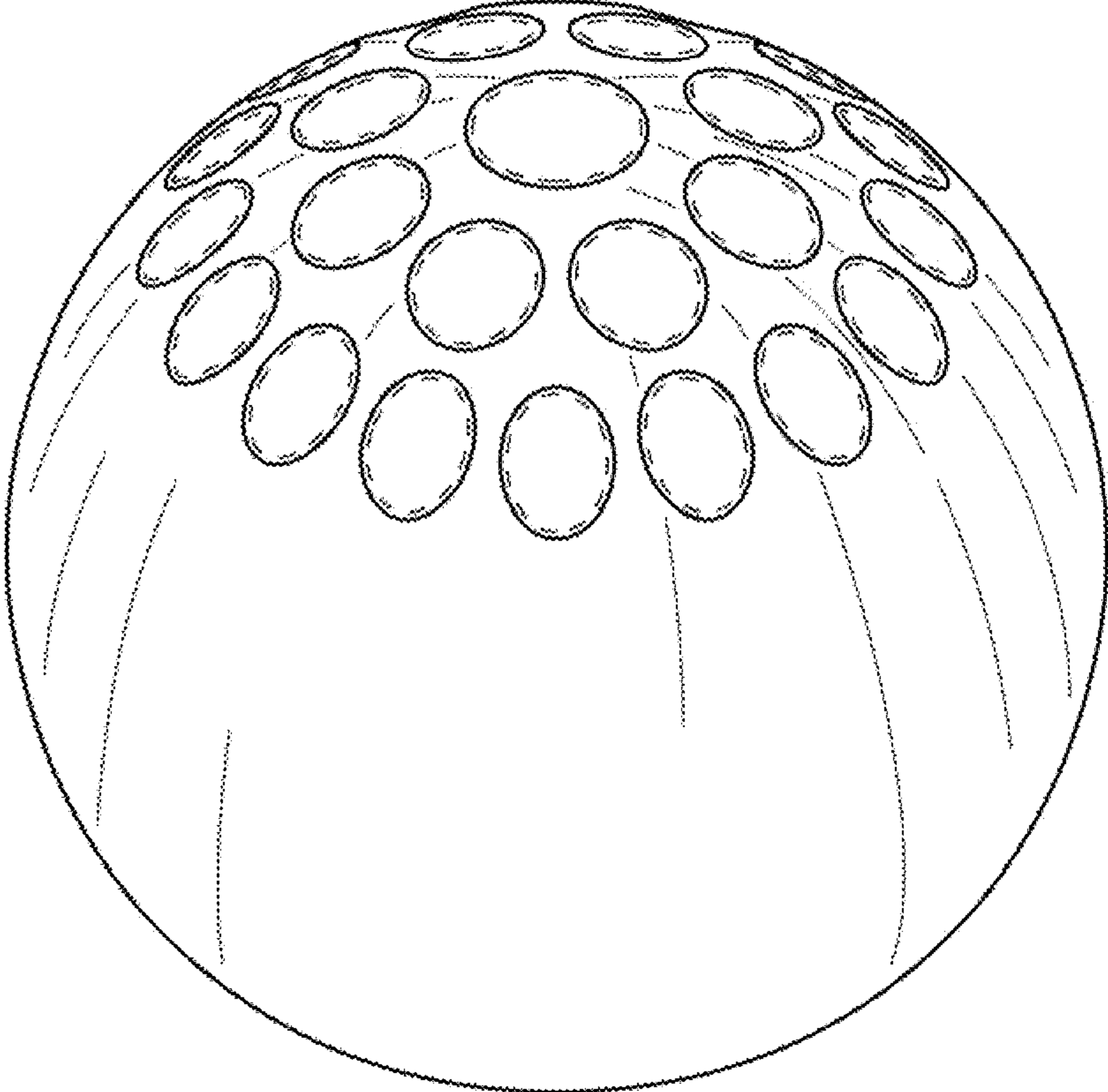

FIG. 1

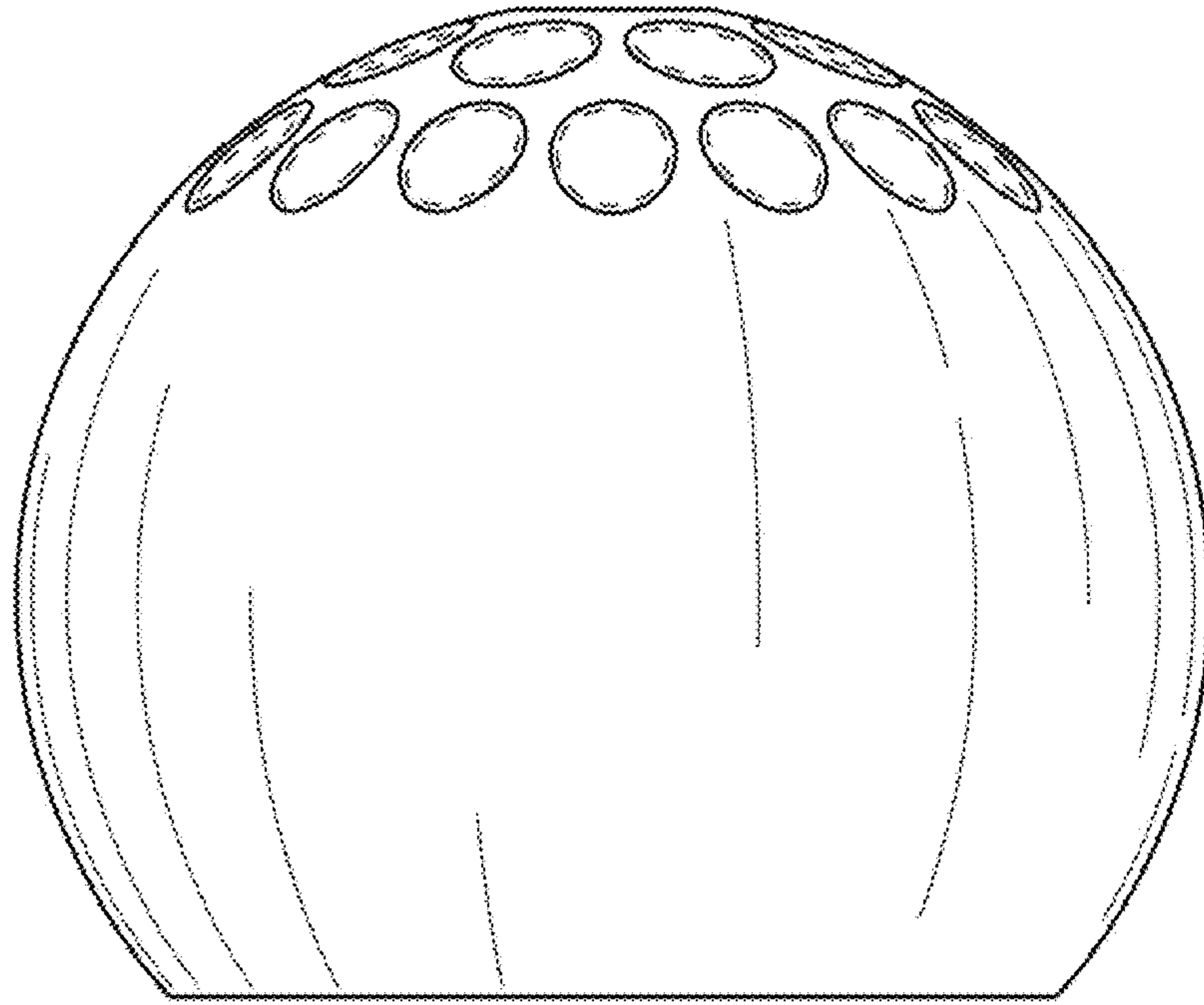

FIG. 2

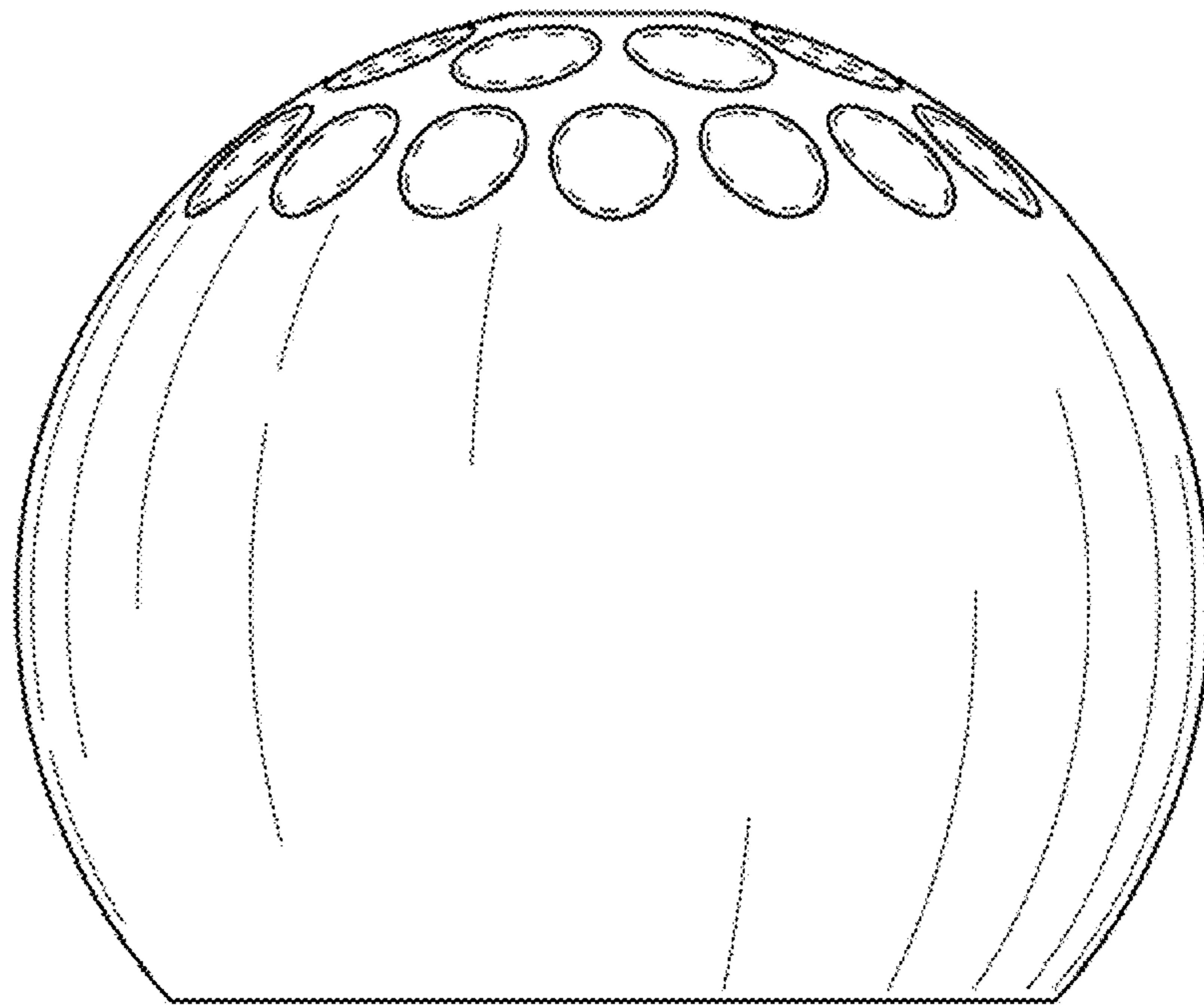

FIG. 3



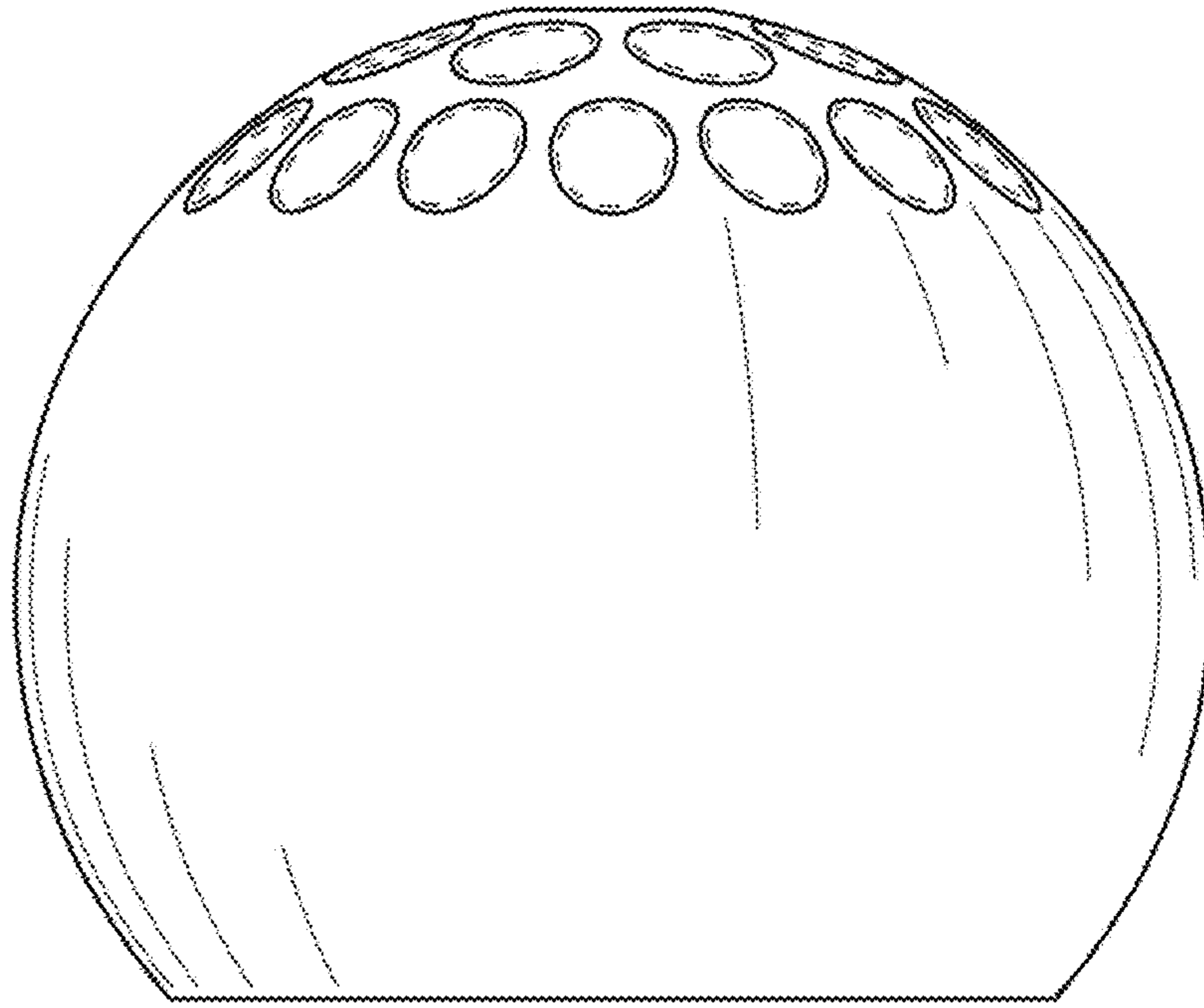

FIG. 4

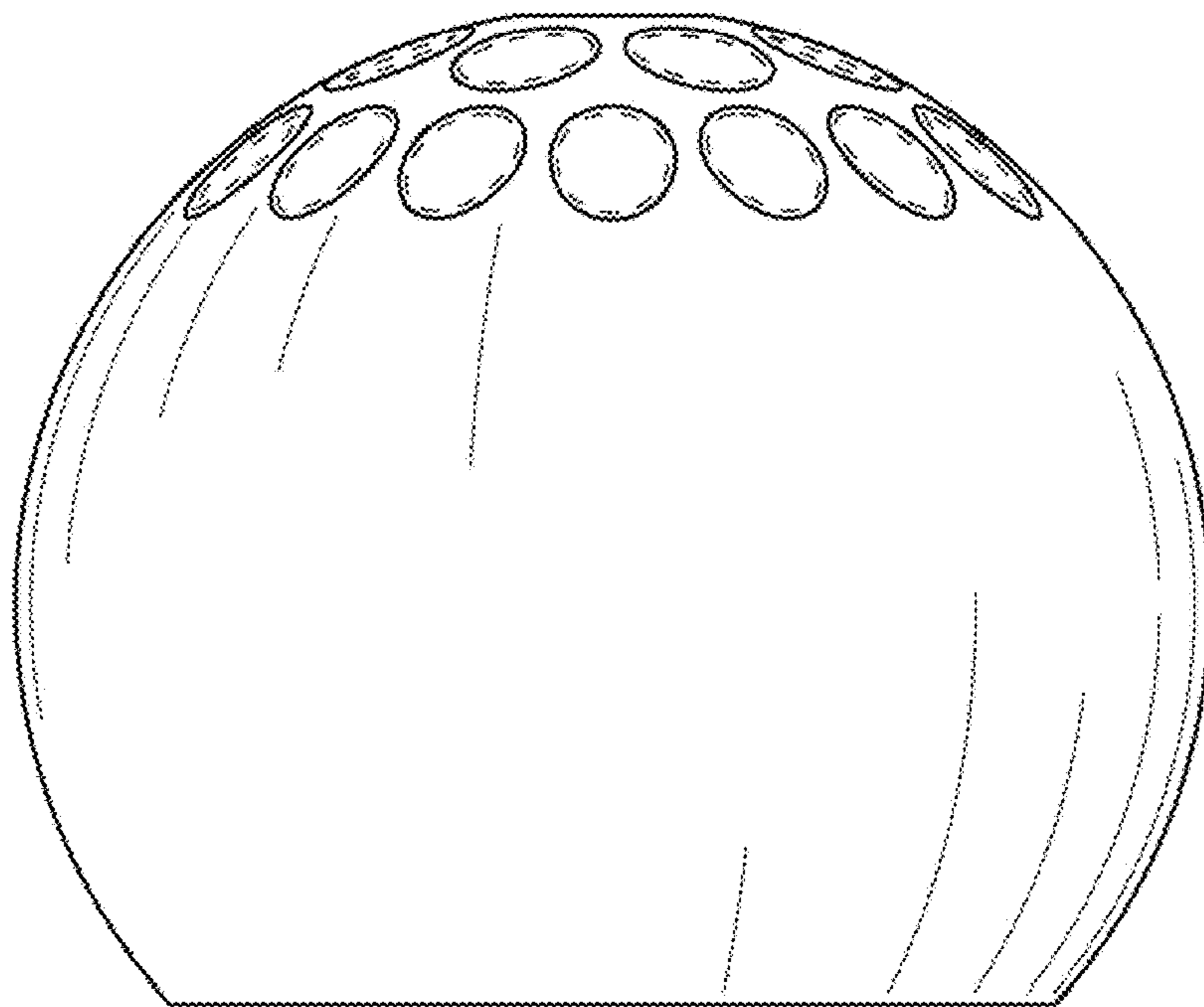

FIG. 5

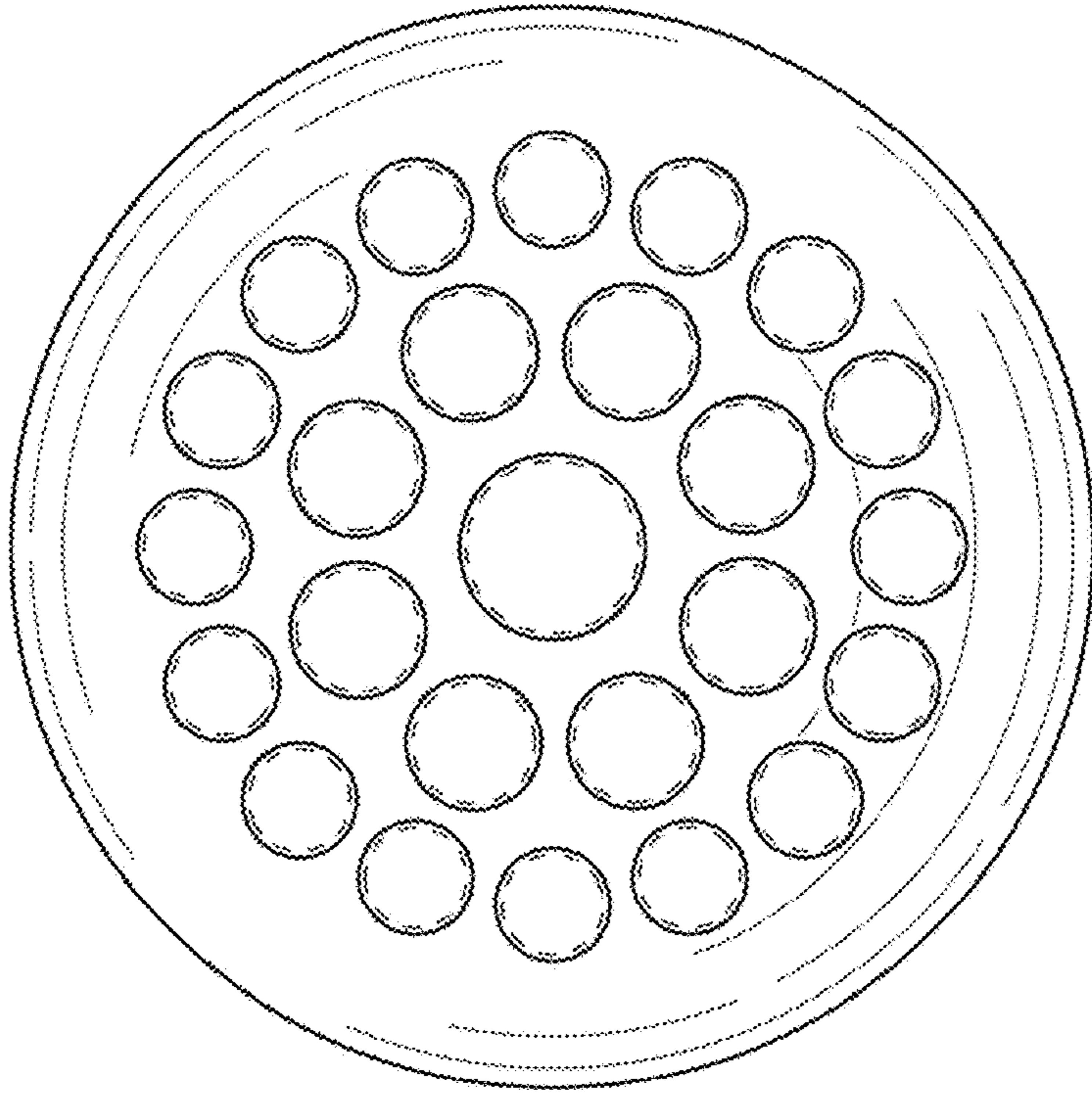

FIG. 6

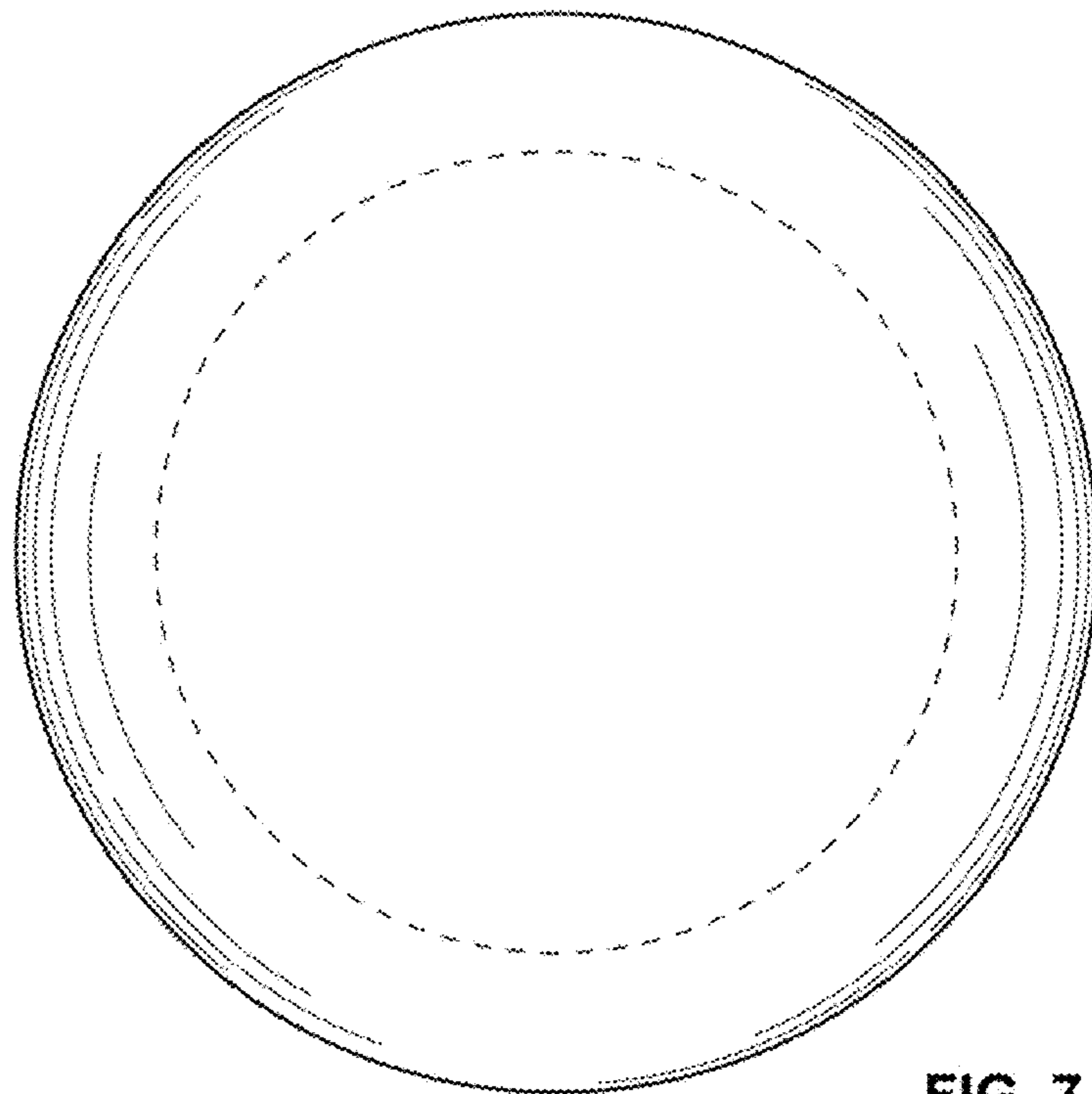

FIG. 7

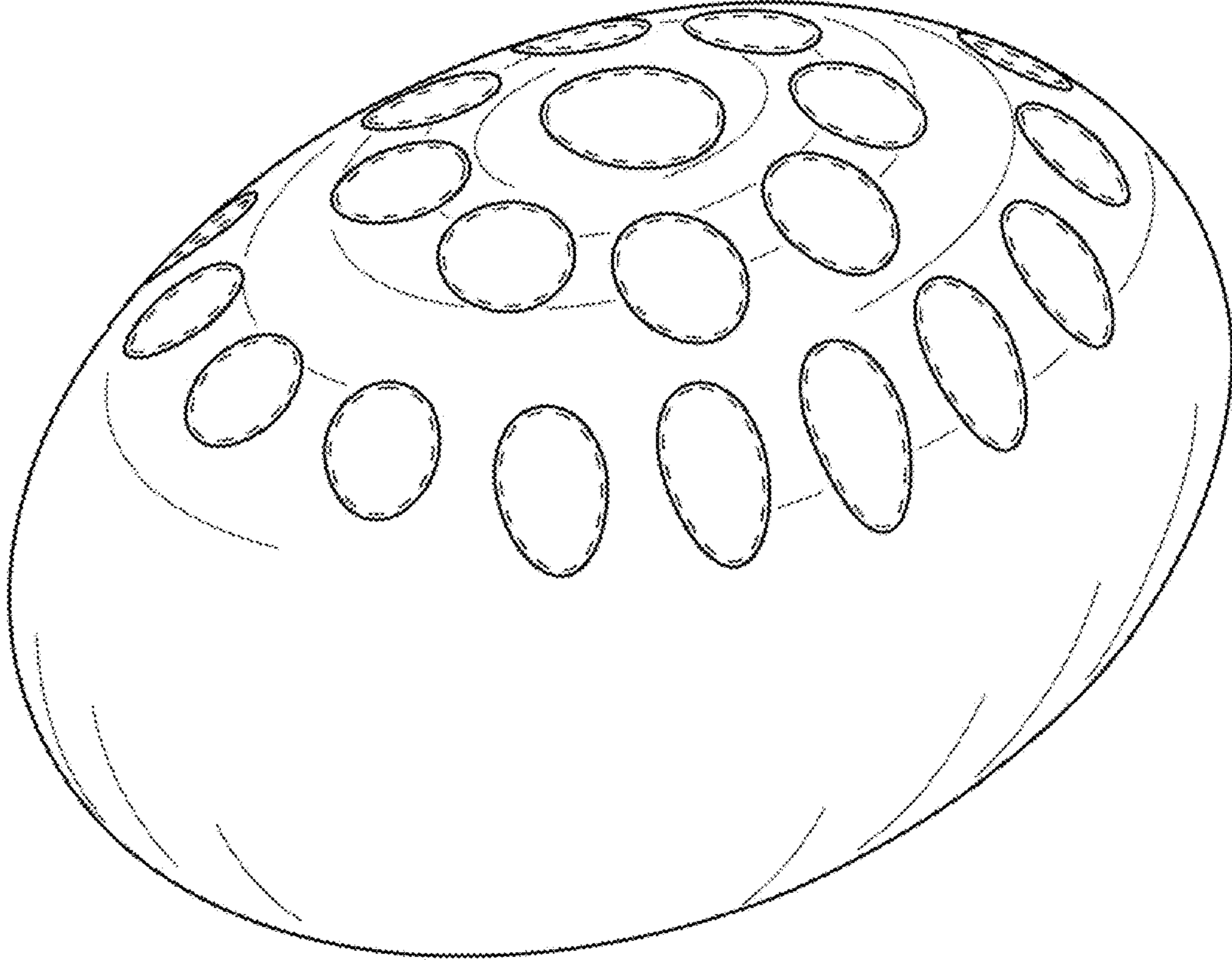

FIG. 8

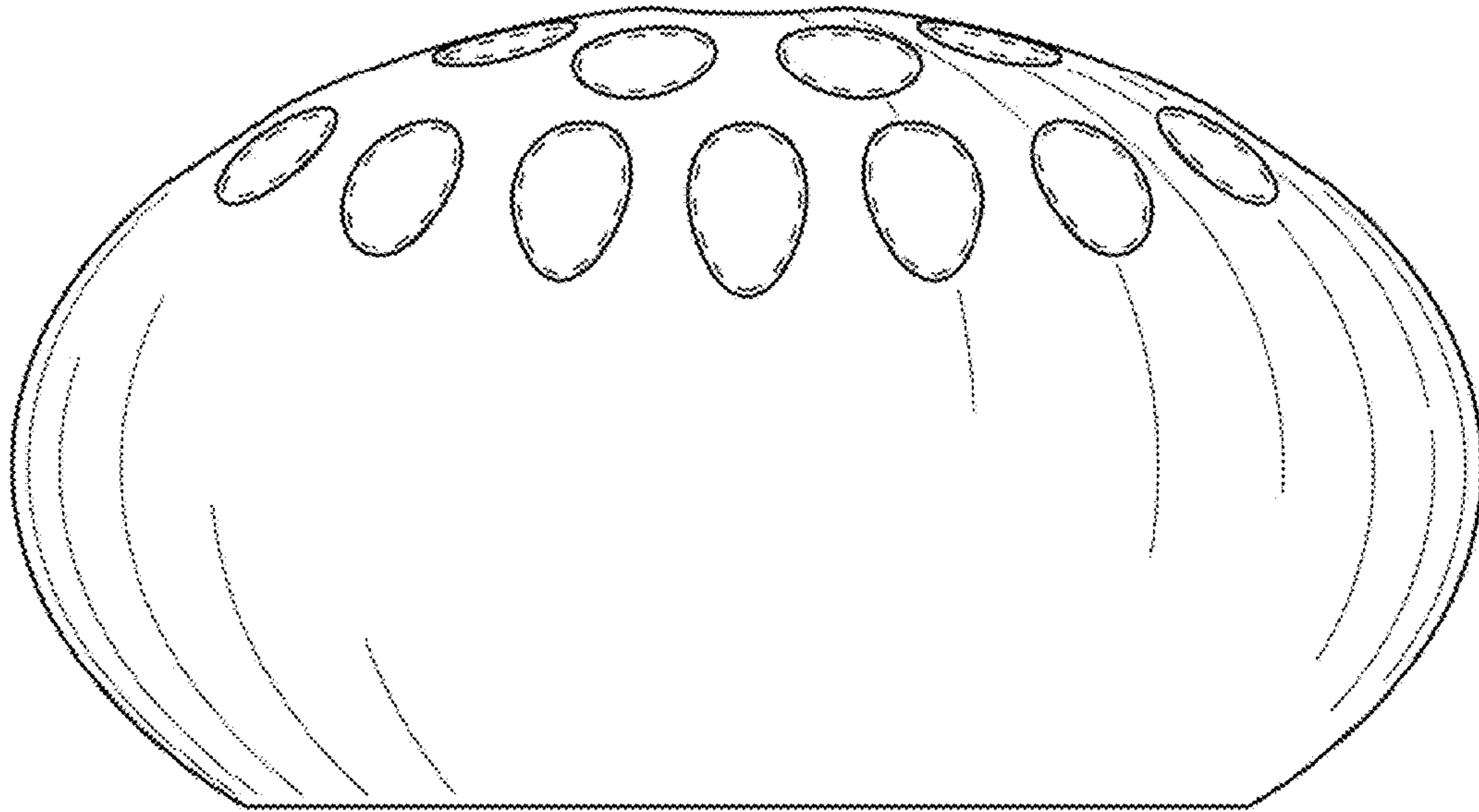

FIG. 9

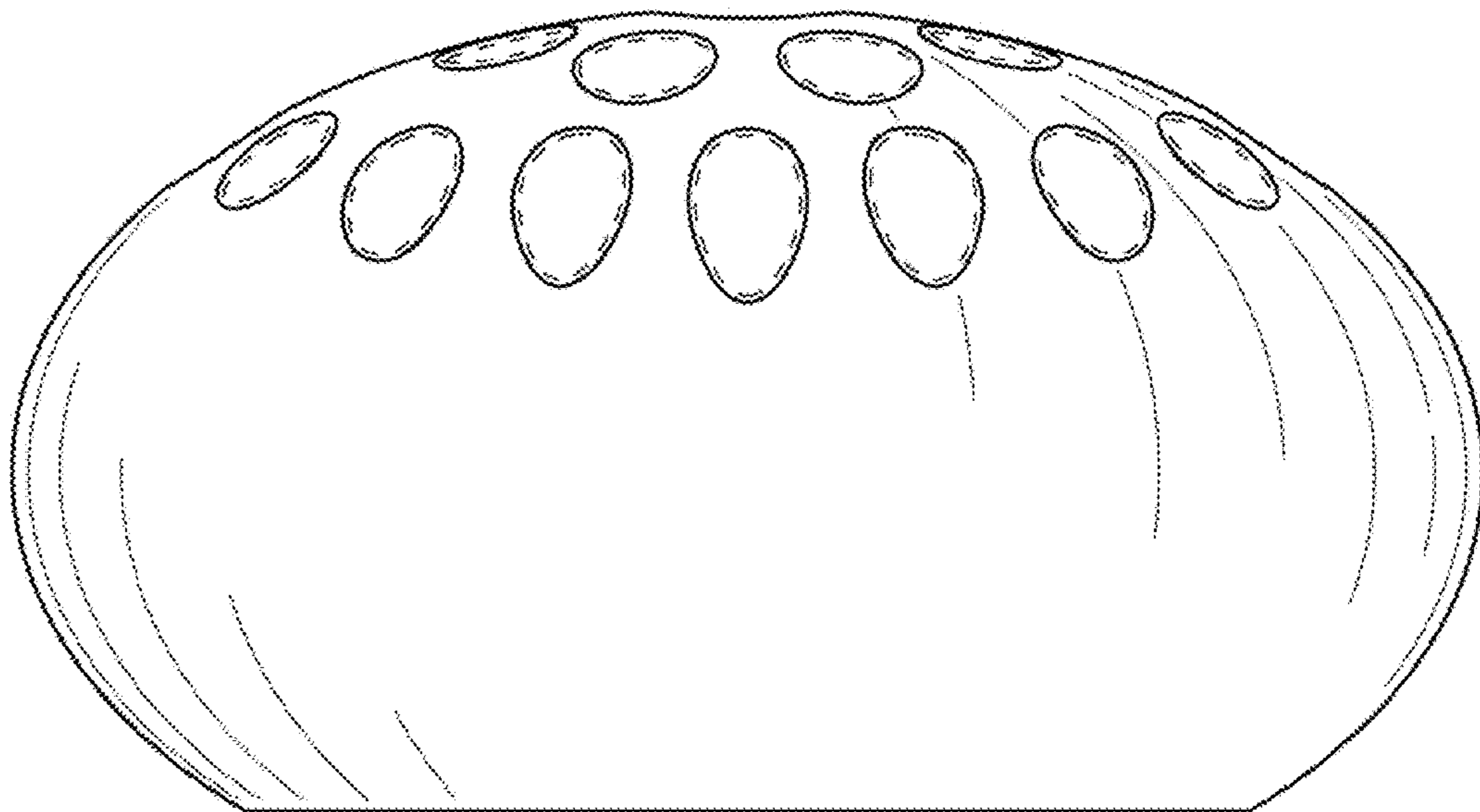

FIG. 10



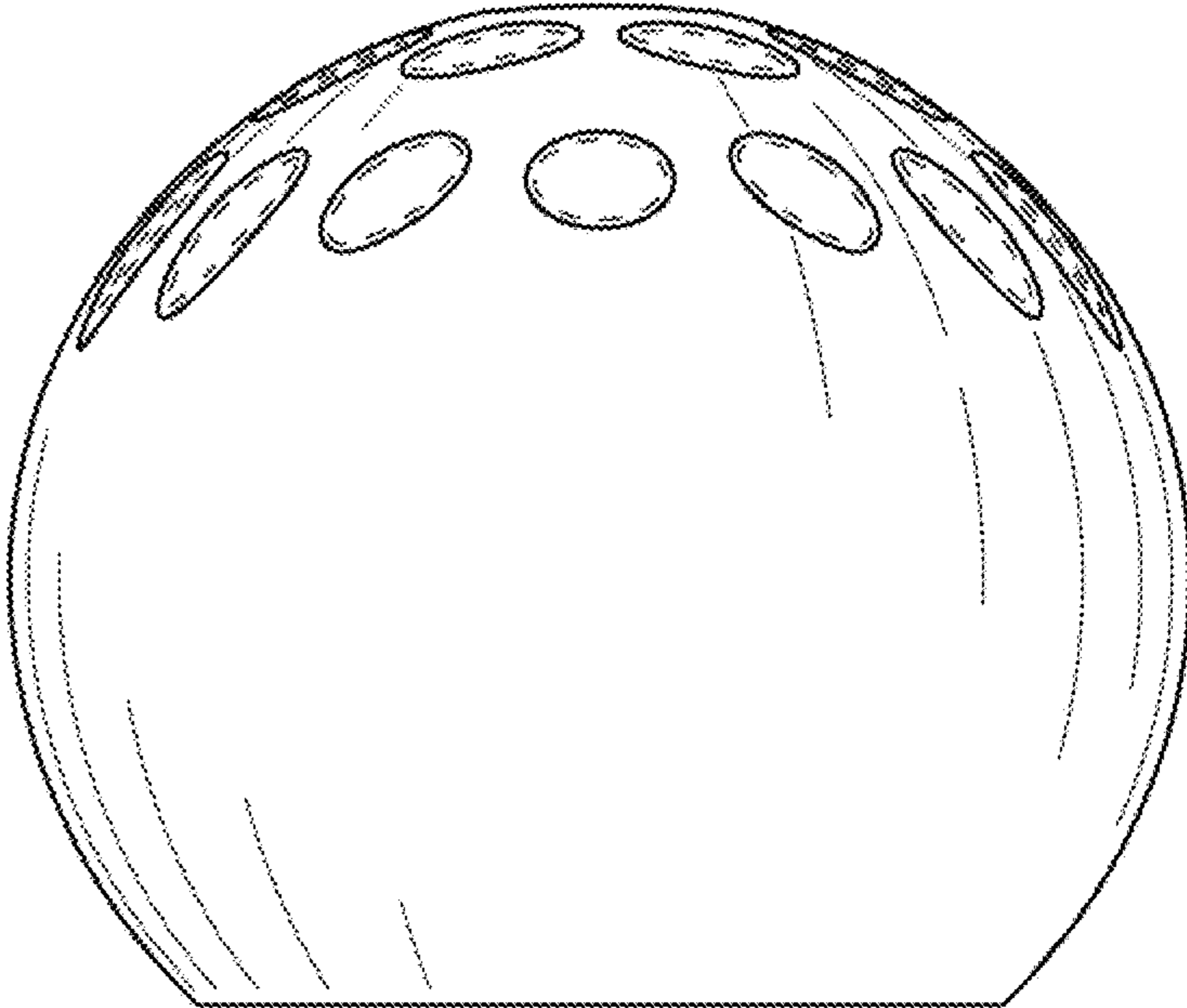

FIG. 11

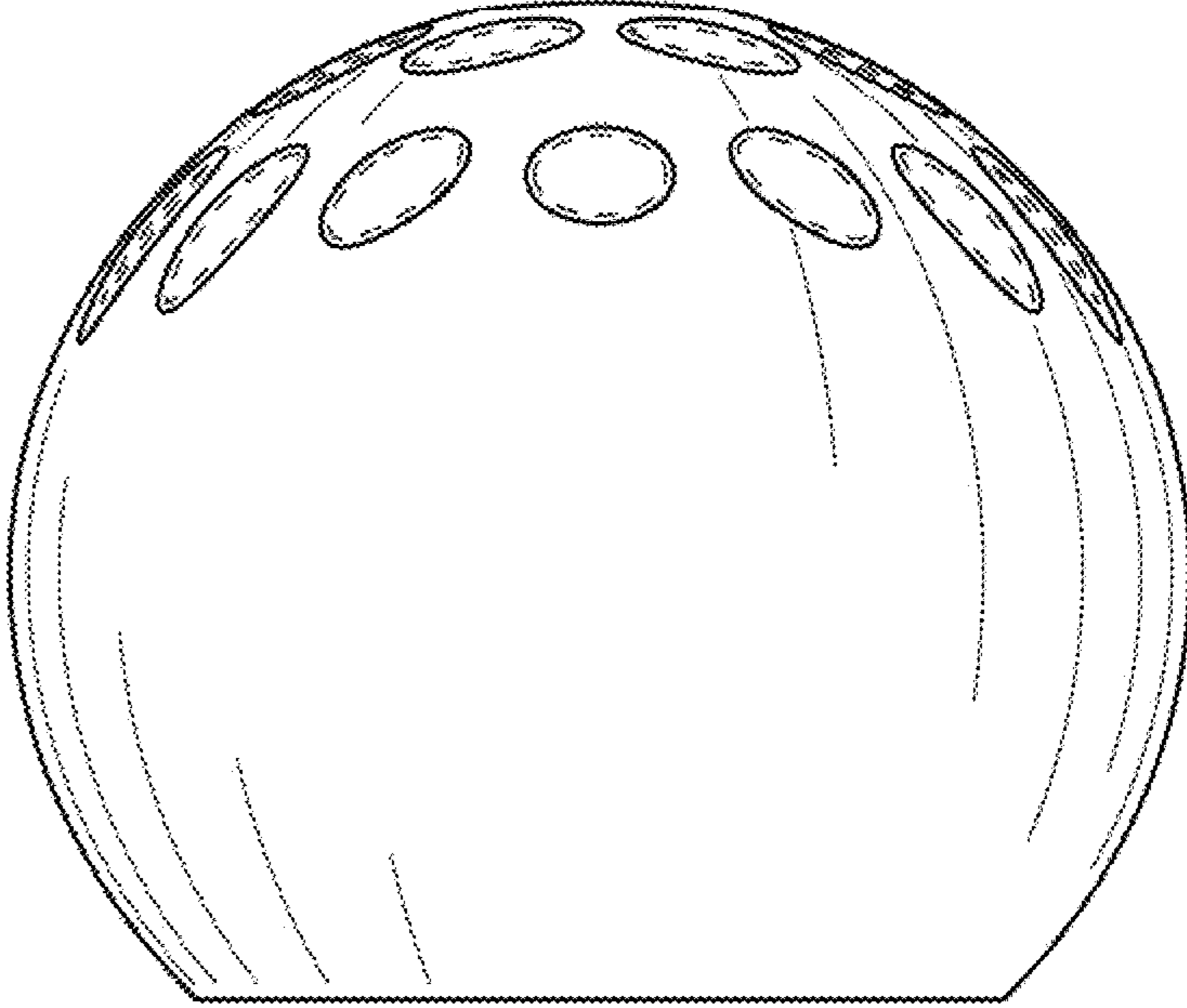

FIG. 12

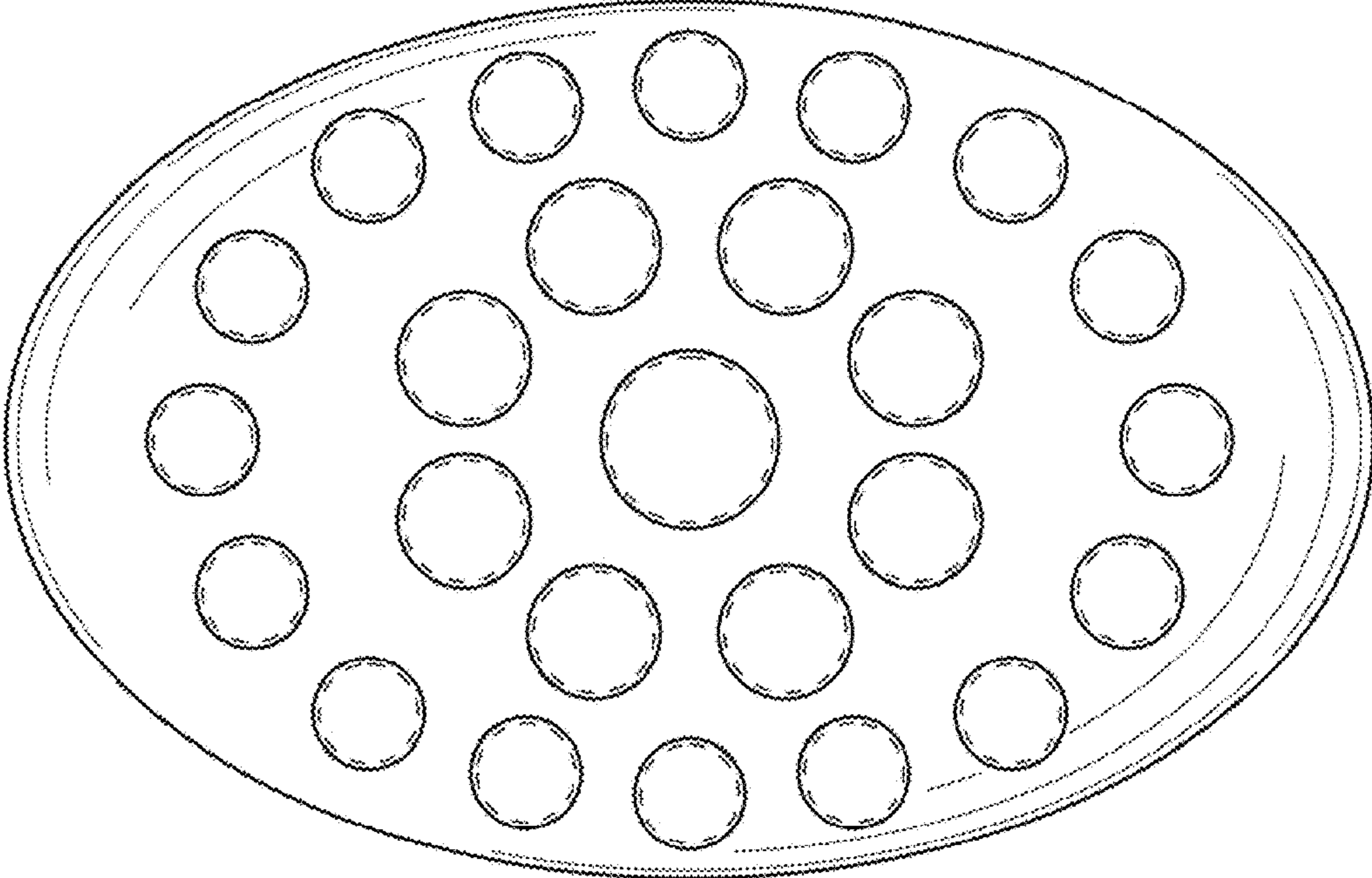

FIG. 13

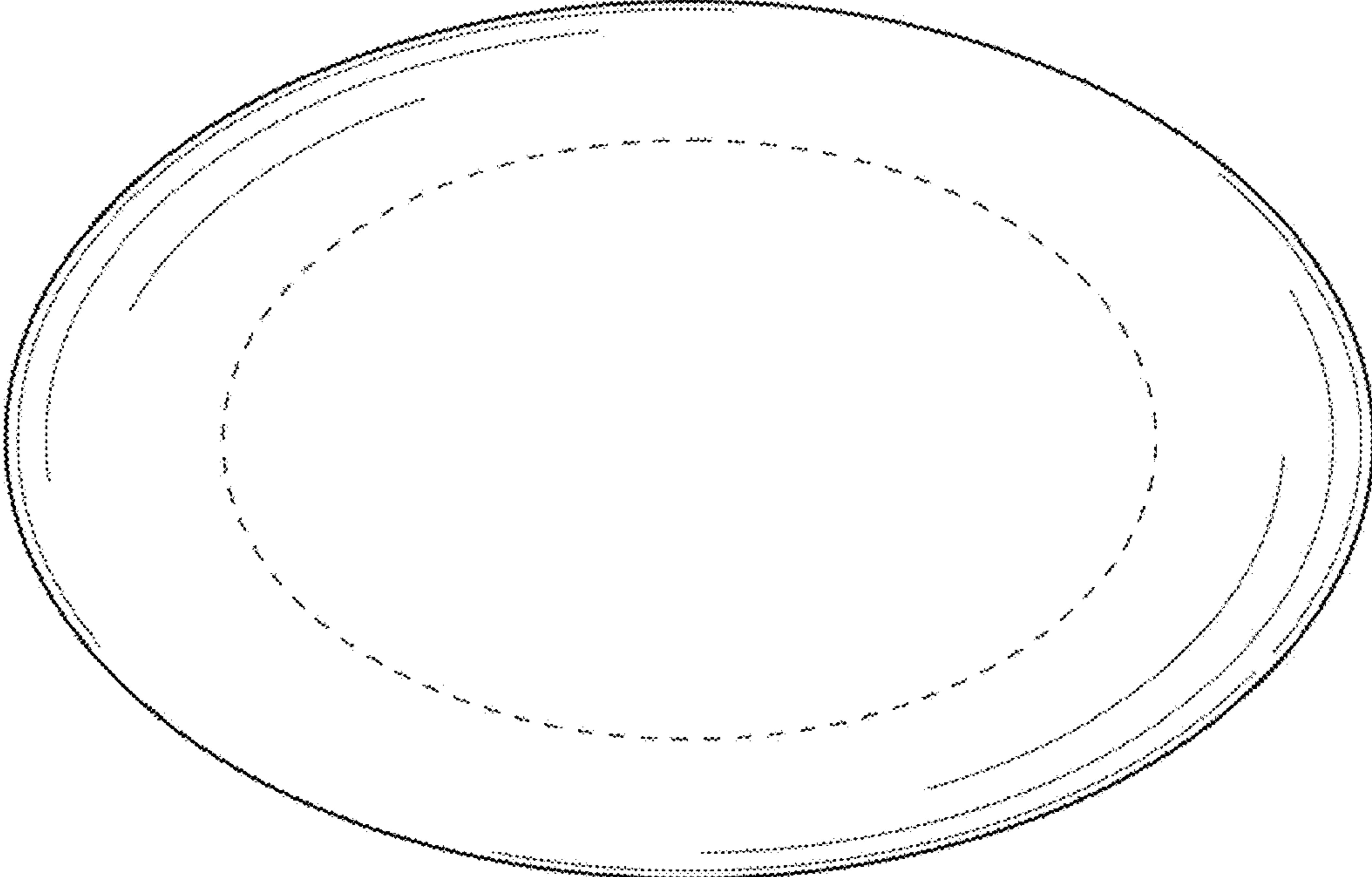

FIG. 14