



US00D810189S

(12) **United States Design Patent** (10) **Patent No.:** **US D810,189 S**  
**Enomoto** (45) **Date of Patent:** **\*\* Feb. 13, 2018**

(54) **COIN DEPOSITING AND DISPENSING APPARATUS**

(71) Applicant: **Asahi Seiko Kabushiki Kaisha**, Tokyo (JP)

(72) Inventor: **Minoru Enomoto**, Saitama (JP)

(73) Assignee: **ASAHI SEIKO KABUSHIKI KAISHA** (JP)

(\*\*) Term: **15 Years**

(21) Appl. No.: **29/543,808**

(22) Filed: **Oct. 28, 2015**

(30) **Foreign Application Priority Data**

Aug. 25, 2015 (JP) ..... 2015-018623

(51) **LOC (11) Cl.** ..... **18-01**

(52) **U.S. Cl.**  
USPC ..... **D18/3.1; D99/34**

(58) **Field of Classification Search**  
USPC ..... D18/3.1, 3.2, 3.3, 12, 12.1, 46, 47, 49;  
D14/900, 901, 902; D99/28, 34-36, 43,  
D99/99; D10/97; D20/1, 2, 4, 5, 6, 8, 9  
CPC .. G07D 1/00; G07D 1/02; G07D 3/00; G07D  
3/14; G07D 3/16; G07D 9/00; G07D  
9/002; G07D 9/008; G07D 9/02; G07D  
9/08; G07D 11/00; G07D 11/0018; G07D  
2201/00; G07F 1/00; G07F 1/04; G07F  
3/00; G07F 3/04  
See application file for complete search history.

(56) **References Cited**

**U.S. PATENT DOCUMENTS**

1,460,878 A \* 7/1923 Allen ..... G07D 1/00  
453/29  
D110,082 S \* 6/1938 Bogress ..... D18/3.1  
3,943,950 A \* 3/1976 Thur ..... G07D 1/00  
192/56.1

4,047,538 A \* 9/1977 Sahni ..... G07D 1/00  
221/266  
D279,792 S \* 7/1985 Childers ..... D18/3.1  
D279,793 S \* 7/1985 Childers ..... D18/3.1  
5,062,598 A \* 11/1991 Winkler ..... G07D 11/0018  
221/21  
D324,600 S \* 3/1992 Ho ..... D99/34  
D335,149 S \* 4/1993 Dabrowski ..... D20/1  
D336,860 S \* 6/1993 Clough ..... D10/42  
D343,717 S \* 1/1994 Nakajima ..... D99/34  
5,469,951 A \* 11/1995 Takemoto ..... G07D 3/16  
194/206

(Continued)

**OTHER PUBLICATIONS**

Coin Dispensing Machines. (Design-Questel). orbit.com. [online PDF] 26 pgs. Print Dates range Jan. 13, 2004-Dec. 12, 2016. [retrieved on Feb. 23, 2017] <https://sobjprd.questel.fr/export/QPTUJ214/pdf2/faac009d-f3fa-4cfb-aca0-6335375c4ea3-212844.pdf>.\*

*Primary Examiner* — Susan Bennett Hattan

*Assistant Examiner* — Marie D. Fast Horse

(57) **CLAIM**

I claim an ornamental design for a coin depositing and dispensing apparatus, as shown and described.

**DESCRIPTION**

FIG. 1 is an upper left side perspective view looking downward at my new design;  
FIG. 2 is a left side view of my new design;  
FIG. 3 is a right side view thereof;  
FIG. 4 is a front side view thereof;  
FIG. 5 is a rear side view thereof;  
FIG. 6 is a top view thereof; and,  
FIG. 7 is a bottom view thereof.

The broken lines in the Figures depict parts of the coin depositing and dispensing apparatus that form no part of the Claim.

**1 Claim, 7 Drawing Sheets**

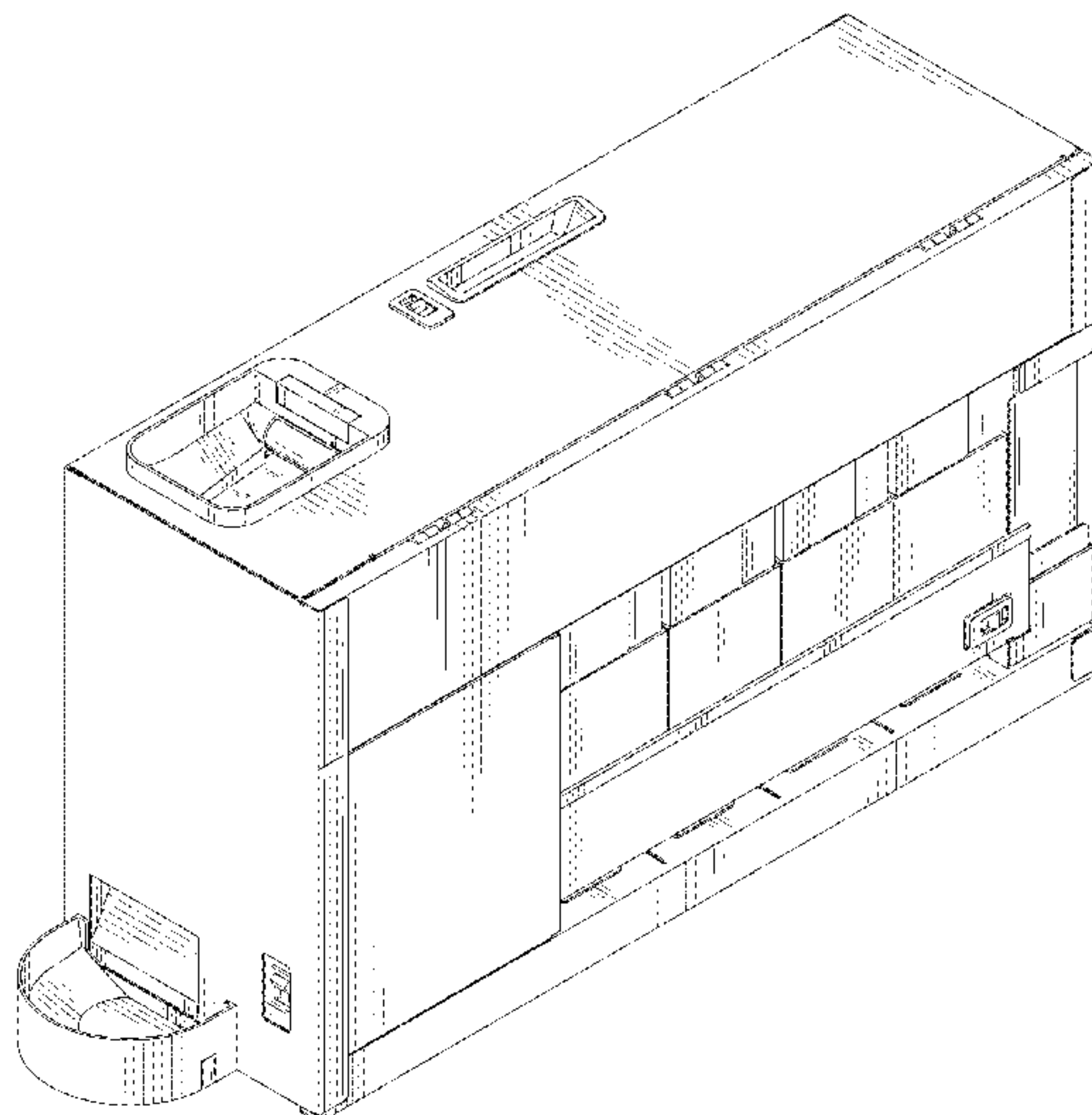



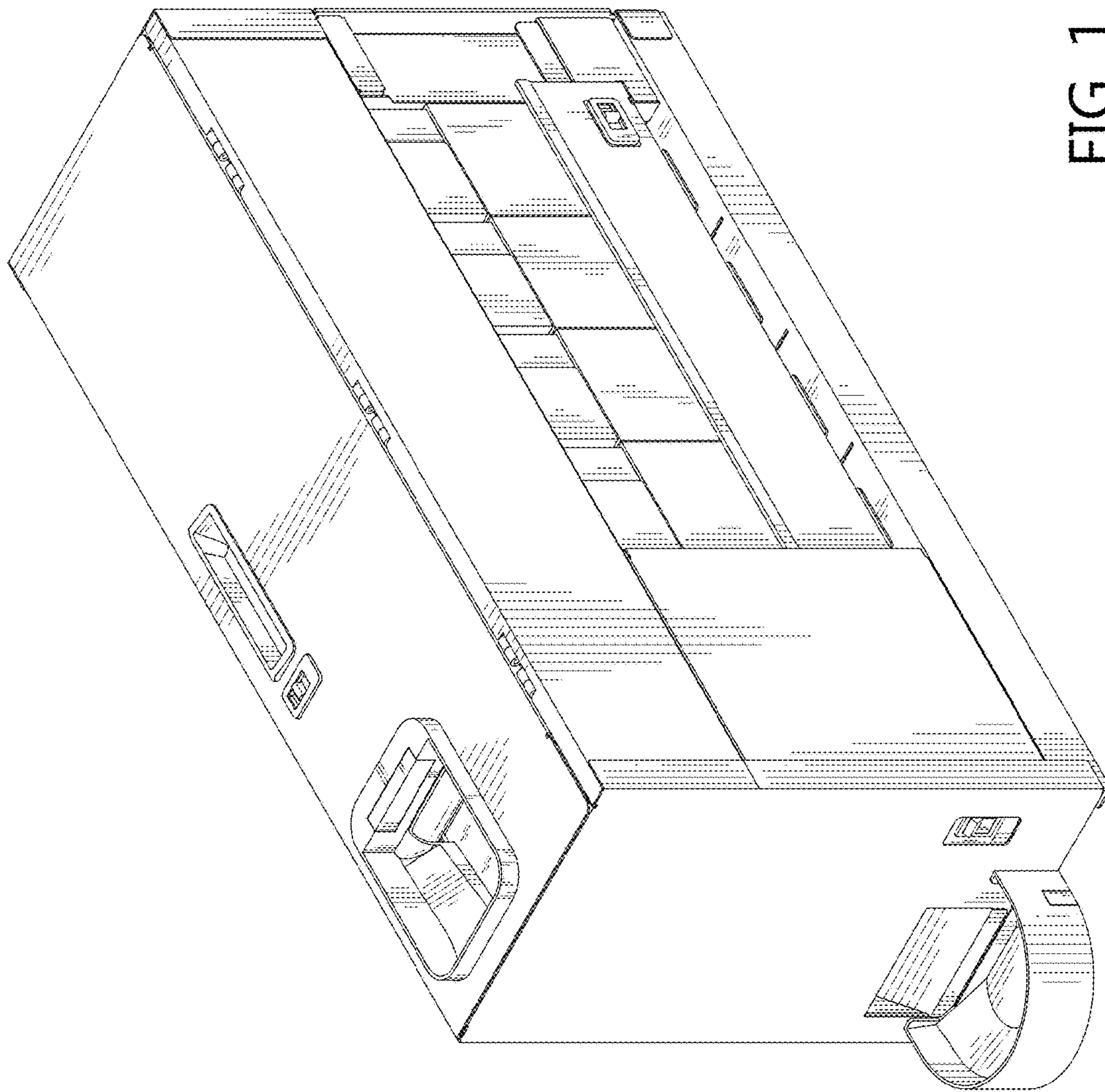

FIG. 1

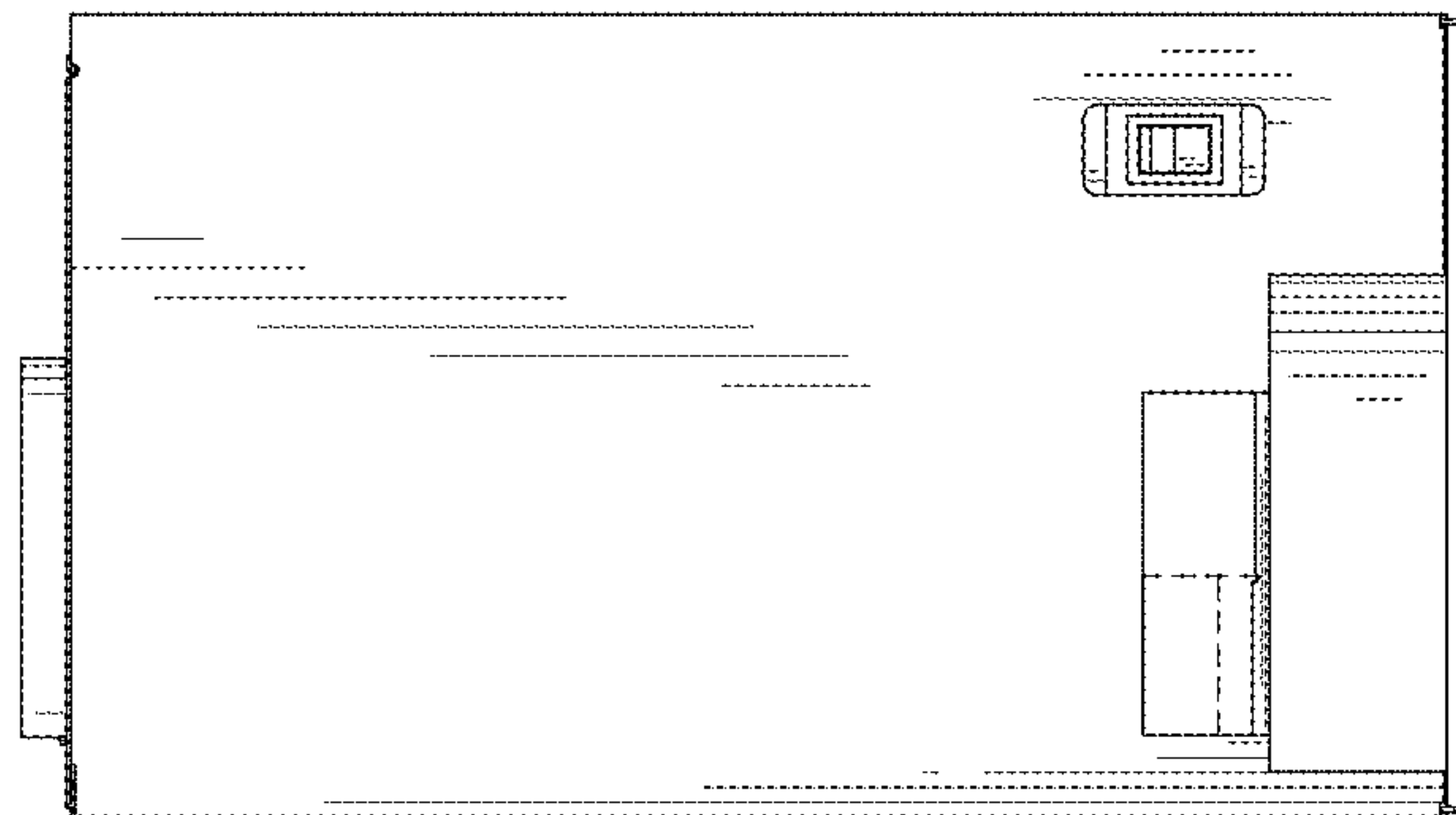

FIG. 2

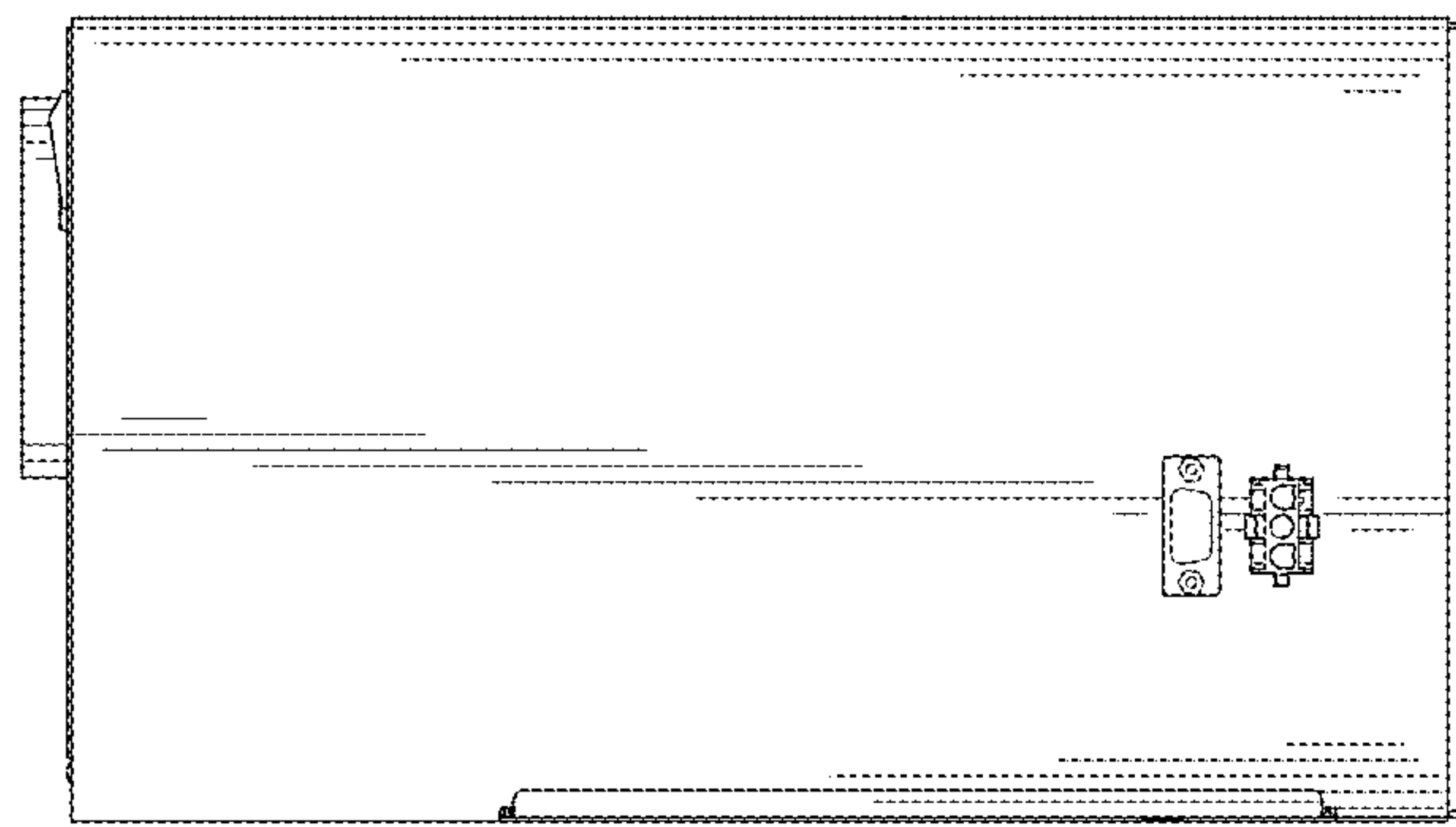

FIG. 3



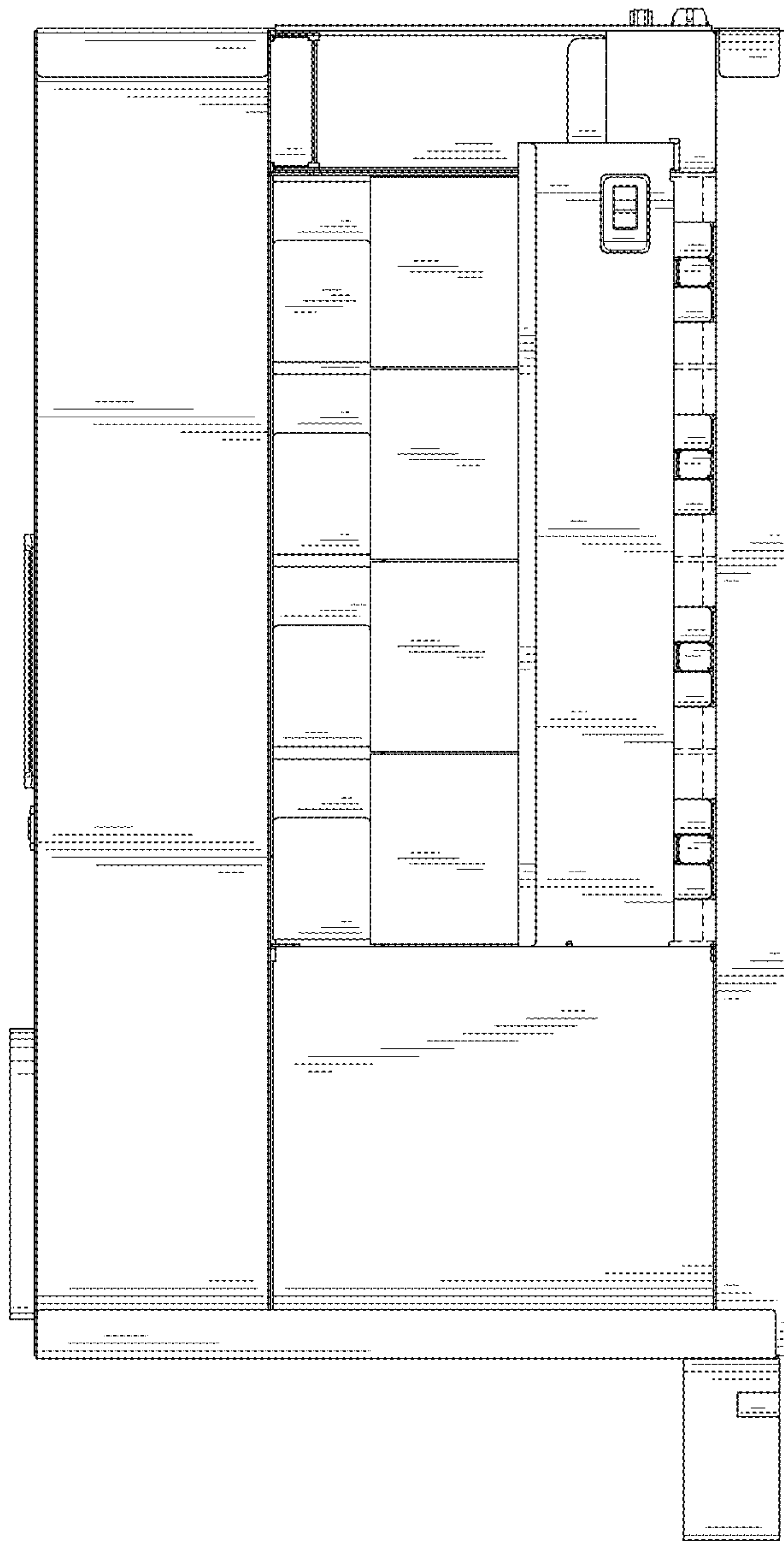

FIG. 4

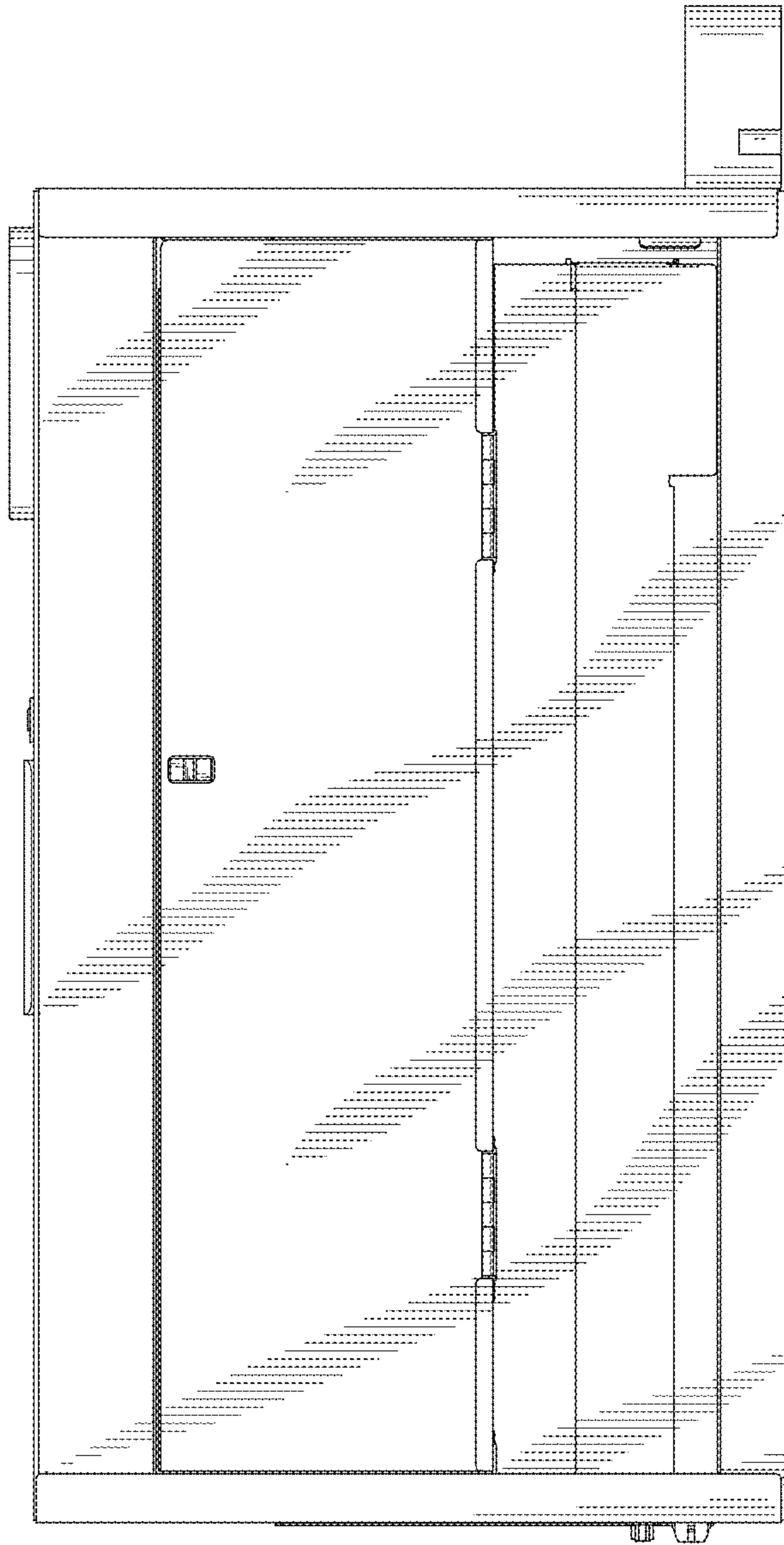

FIG. 5

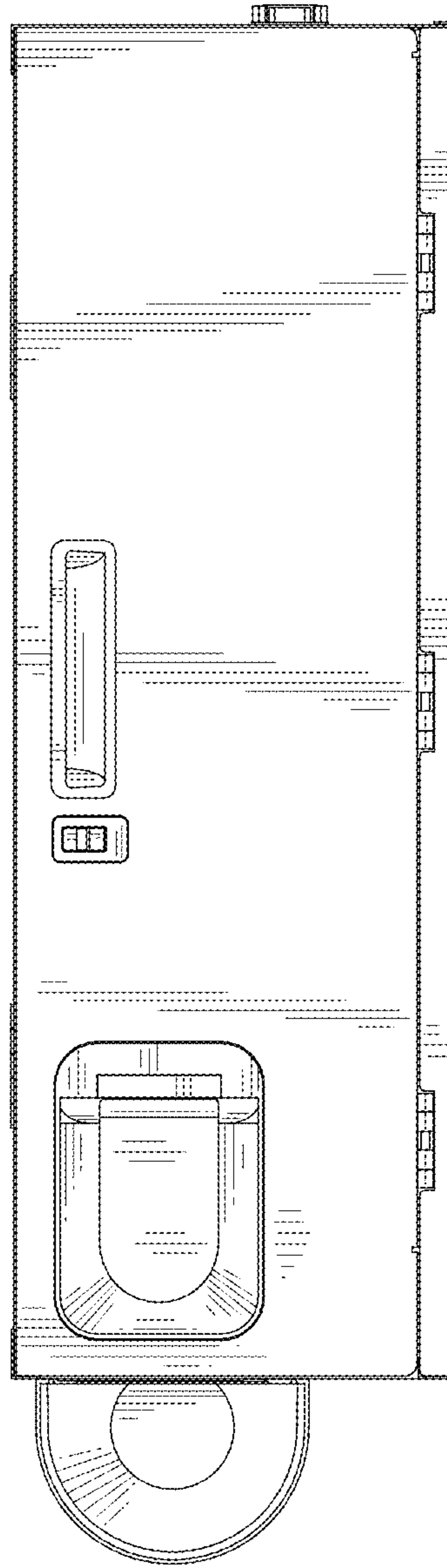

FIG. 6



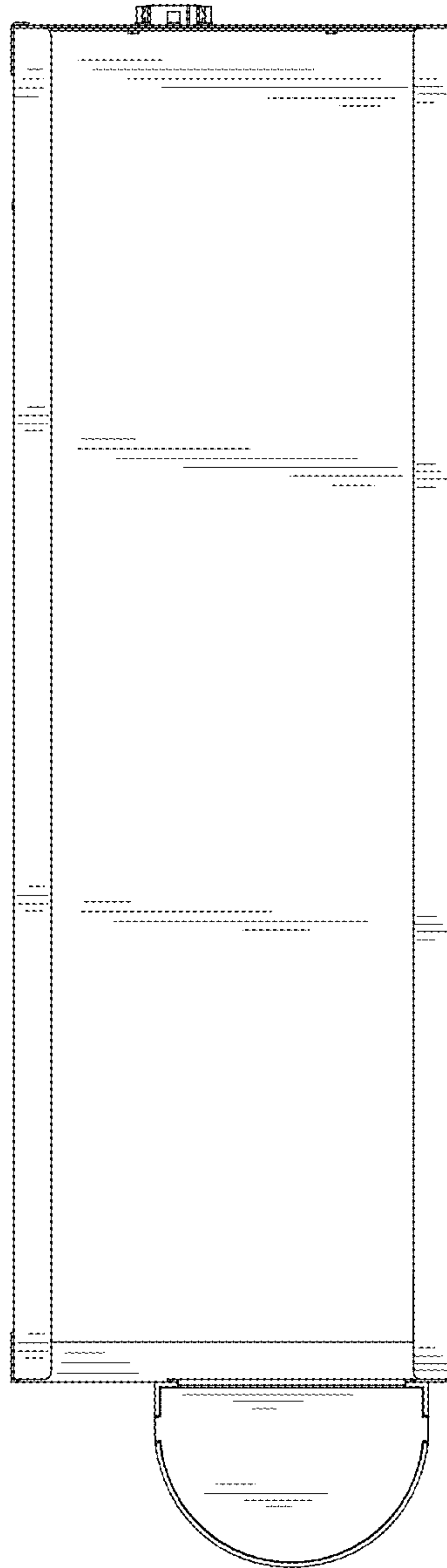

FIG. 7