



US00D810183S

(12) **United States Design Patent**  
**Garfias**

(10) **Patent No.:** **US D810,183 S**  
(45) **Date of Patent:** **\*\* Feb. 13, 2018**

(54) **EYEGLASS COMPONENT**  
(71) Applicant: **Oakley, Inc.**, Foothill Ranch, CA (US)  
(72) Inventor: **Nicolas Adolfo Garfias**, Long Beach, CA (US)  
(73) Assignee: **Oakley, Inc.**, Foothill Ranch, CA (US)  
(\*\*) Term: **15 Years**

D591,787 S 5/2009 Yee  
D623,683 S \* 9/2010 Rohrbach ..... D16/315  
D640,725 S 6/2011 Moritz et al.  
D646,317 S \* 10/2011 Serlenga ..... D16/315  
D675,664 S 2/2013 Moritz  
D681,093 S 4/2013 Slosar et al.  
D687,481 S 8/2013 Moritz  
D700,931 S \* 3/2014 Miera ..... D16/315  
D705,339 S 5/2014 Yoo  
(Continued)

(21) Appl. No.: **29/582,950**  
(22) Filed: **Nov. 1, 2016**  
(51) **LOC (11) Cl.** ..... **16-06**  
(52) **U.S. Cl.**  
USPC ..... **D16/313**  
(58) **Field of Classification Search**  
USPC ..... D16/101, 300-342, 900; D29/109-110;  
D21/483, 659-661; D14/372; 351/41,  
351/44, 45-48, 51-52, 62, 158, 92,  
351/103-123, 140-153, 63, 59; 2/13, 15,  
2/426-432, 447-449, 441, 434-437  
CPC ..... G02C 2200/08; G02C 1/06; G02C 5/14;  
G02C 11/02; G02C 11/04; G02C 5/16;  
G02C 2200/22; G02C 5/146; G02C  
5/2254; G02C 5/008; G01C 5/16; A61M  
2021/0044; A63B 33/002  
See application file for complete search history.

**OTHER PUBLICATIONS**

Speed Jacket announced unknown, [online], [site visited Oct. 26, 2017]. Available from Internet, <URL: <http://www.oakley.com/en/mens/sunglasses/sport-sunglasses/speed-jacket-prizm-shallow-water-polarized-standard-issue/product/W0009228PZSWSI/?skuCode=OO9228-08&variant=888392229366&categoryCode=m0203>>.\*

(Continued)

*Primary Examiner* — Eric L Goodman  
*Assistant Examiner* — Sanjeev Paul  
(74) *Attorney, Agent, or Firm* — Sterne, Kessler, Goldstein & Fox P.L.L.C.

(57) **CLAIM**

The ornamental design for an eyeglass component, as shown and described.

**DESCRIPTION**

FIG. 1 is a front perspective view of an eyeglass component showing the new design;  
FIG. 2 is a front elevational view thereof;  
FIG. 3 is a rear elevational view thereof;  
FIG. 4 is a left side elevational view thereof, the right side elevational view being a mirror image thereof;  
FIG. 5 is a top plan view thereof; and,  
FIG. 6 is a bottom plan view thereof.  
The broken lines in the Figures show portions of the eyeglass which form no part of the claimed design.

**1 Claim, 4 Drawing Sheets**

(56) **References Cited**

**U.S. PATENT DOCUMENTS**

6,193,367 B1 \* 2/2001 Lee ..... G02C 1/02  
351/103  
6,196,681 B1 \* 3/2001 Canavan ..... G02C 1/04  
351/103  
D543,572 S 5/2007 Yee et al.  
D553,177 S 10/2007 Chen  
D564,568 S 3/2008 Moritz  
D564,571 S 3/2008 Jannard et al.  
D569,412 S 5/2008 Jannard et al.  
D581,443 S 11/2008 Jannard et al.  
D581,444 S 11/2008 Jannard et al.  
D582,960 S 12/2008 Fuchs

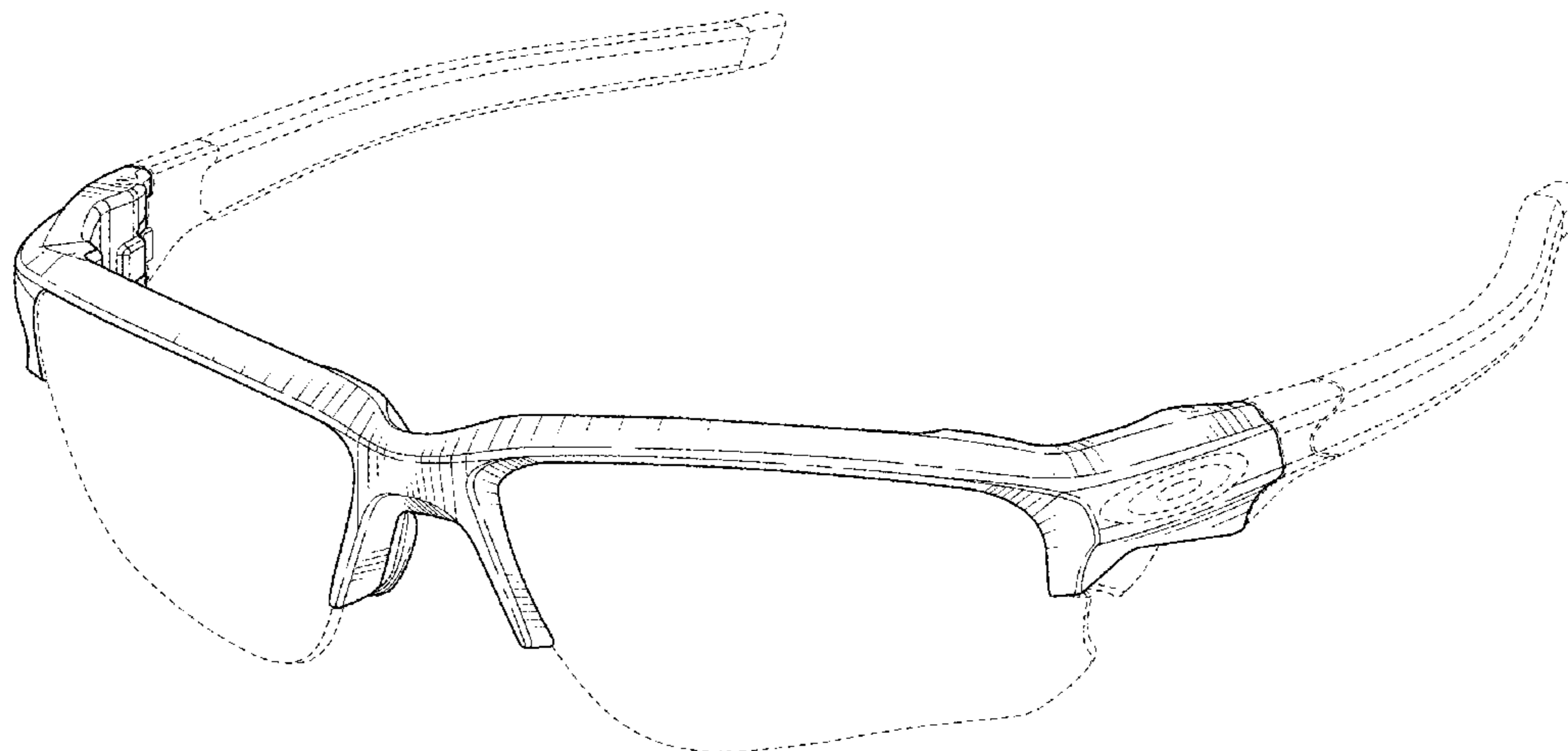

(56)

**References Cited**

U.S. PATENT DOCUMENTS

D718,370	S	*	11/2014	Votel	.....	D16/315
D724,648	S	*	3/2015	Yoo	.....	D16/315
D727,407	S		4/2015	Yoo		
D730,431	S	*	5/2015	Yoo	.....	D16/315
D736,304	S	*	8/2015	Earley	.....	D16/315
D747,402	S	*	1/2016	Shin	.....	D16/320
D778,340	S	*	2/2017	Garfias	.....	D16/315
D783,080	S	*	4/2017	Garfias	.....	D16/314
D783,708	S	*	4/2017	Chae	.....	D16/335
D785,075	S	*	4/2017	Ge	.....	D16/309
D789,440	S	*	6/2017	Uhm	.....	D16/330
2017/0100287	A1		4/2017	Calilung et al.		

OTHER PUBLICATIONS

- U.S. Appl. No. 29/548,418, filed Dec. 14, 2015, Garfias.
- U.S. Appl. No. 29/582,941, filed Nov. 1, 2016, Thixton.
- U.S. Appl. No. 29/582,942, filed Nov. 1, 2016, Thixton.
- U.S. Appl. No. 29/582,944, filed Nov. 1, 2016, Thixton.
- U.S. Appl. No. 29/582,945, filed Nov. 1, 2016, Garfias.
- U.S. Appl. No. 29/582,951, filed Nov. 1, 2016, Garfias.
- U.S. Appl. No. 29/952,956, filed Nov. 1, 2016, Garfias.
- U.S. Appl. No. 29/582,951, Eyeglass, filed Nov. 1, 2016.
- U.S. Appl. No. 29/582,945, Set of Eyeglass Components or Portions Thereof, filed Nov. 1, 2016.
- U.S. Appl. No. 29/582,956, Eyeglass Lens, filed Nov. 1, 2016.
- U.S. Appl. No. 15/481,850, filed Apr. 7, 2017, Calilung, et al.

\* cited by examiner

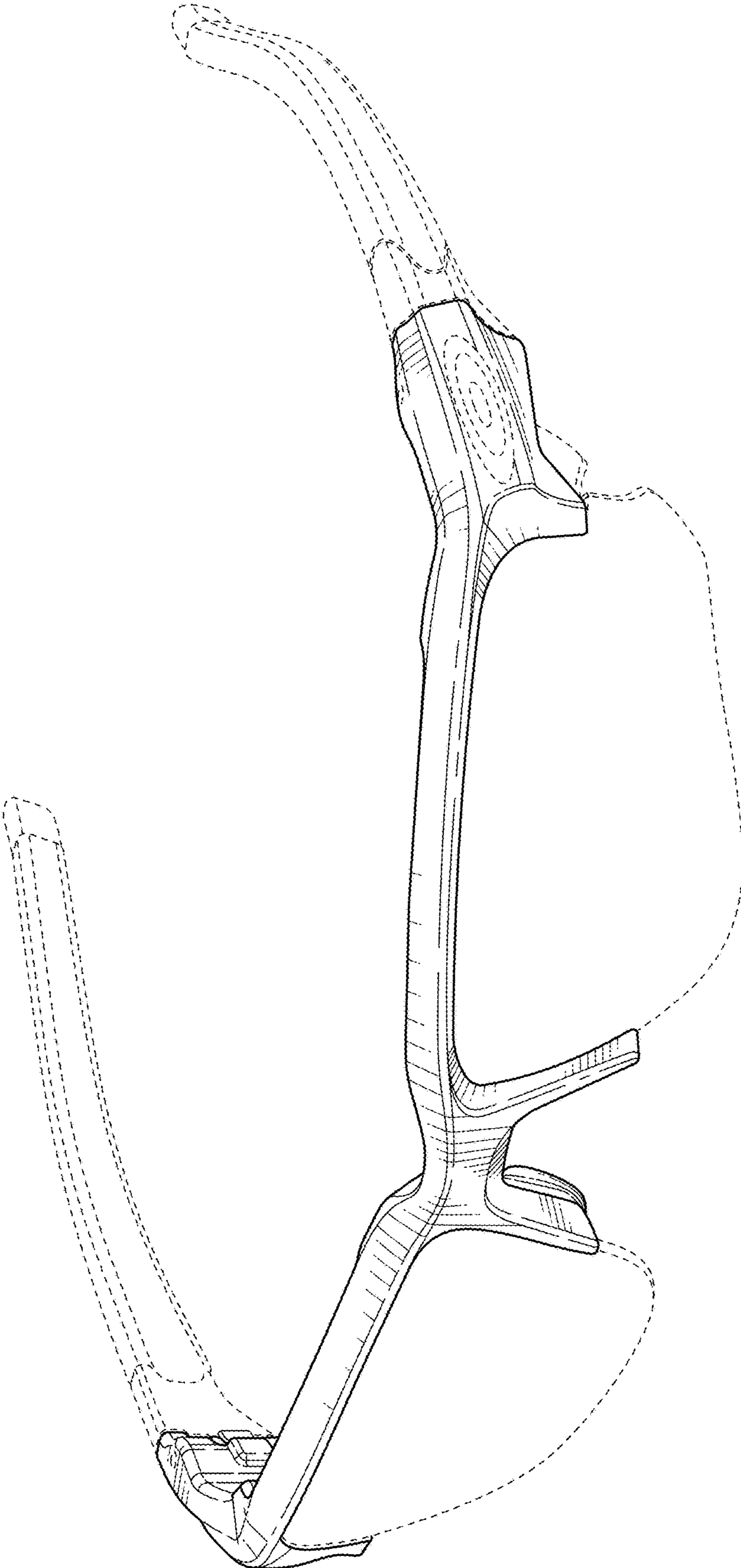

FIG. 1

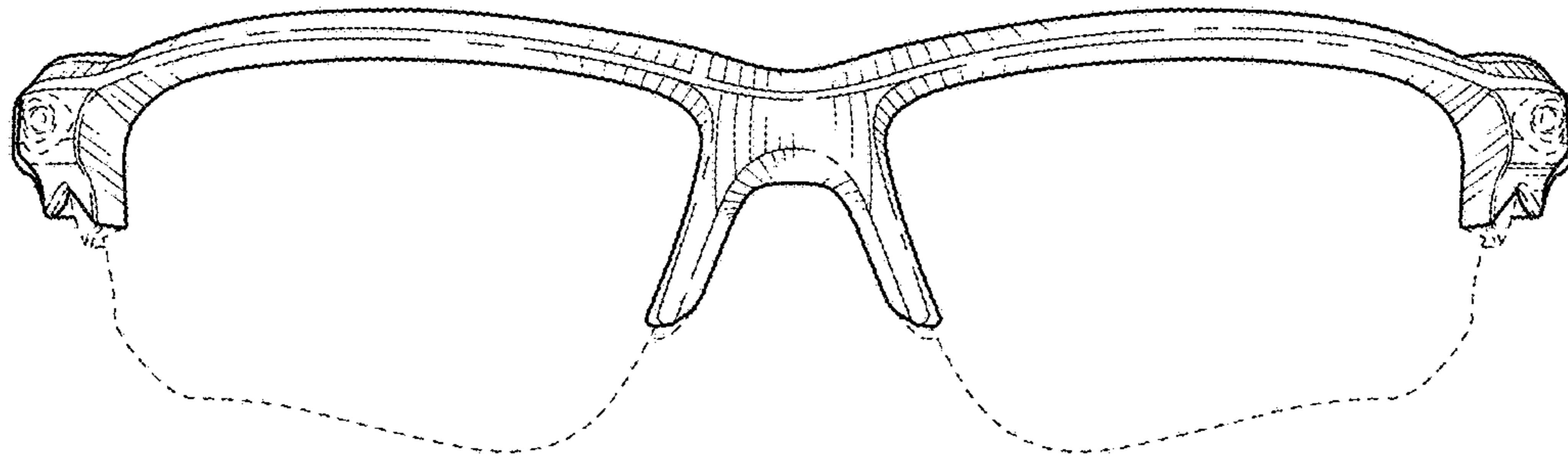

FIG. 2

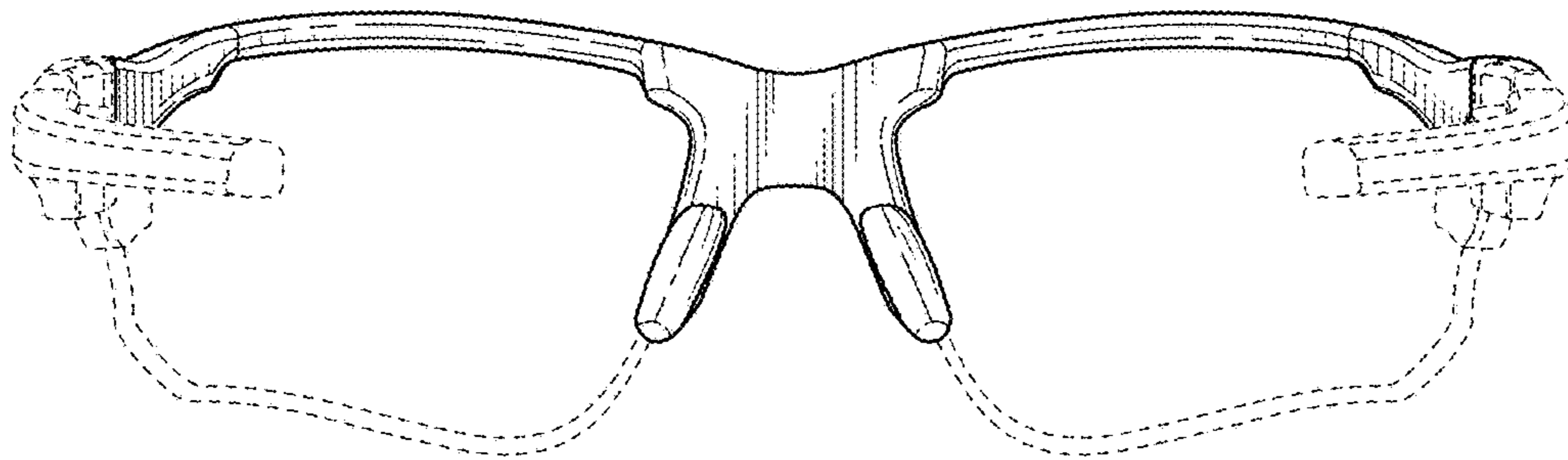

FIG. 3

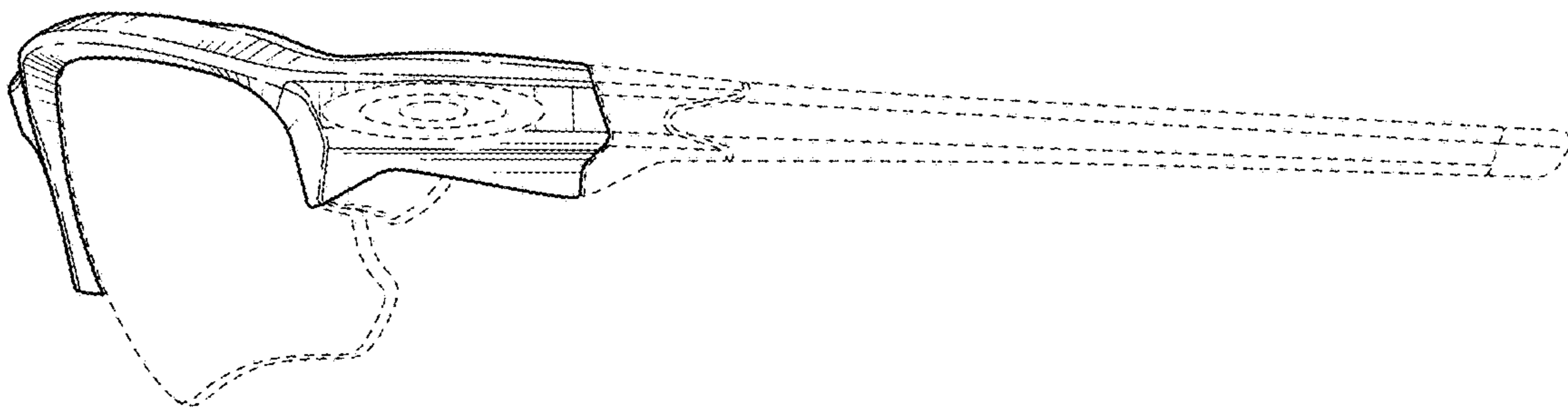

FIG. 4



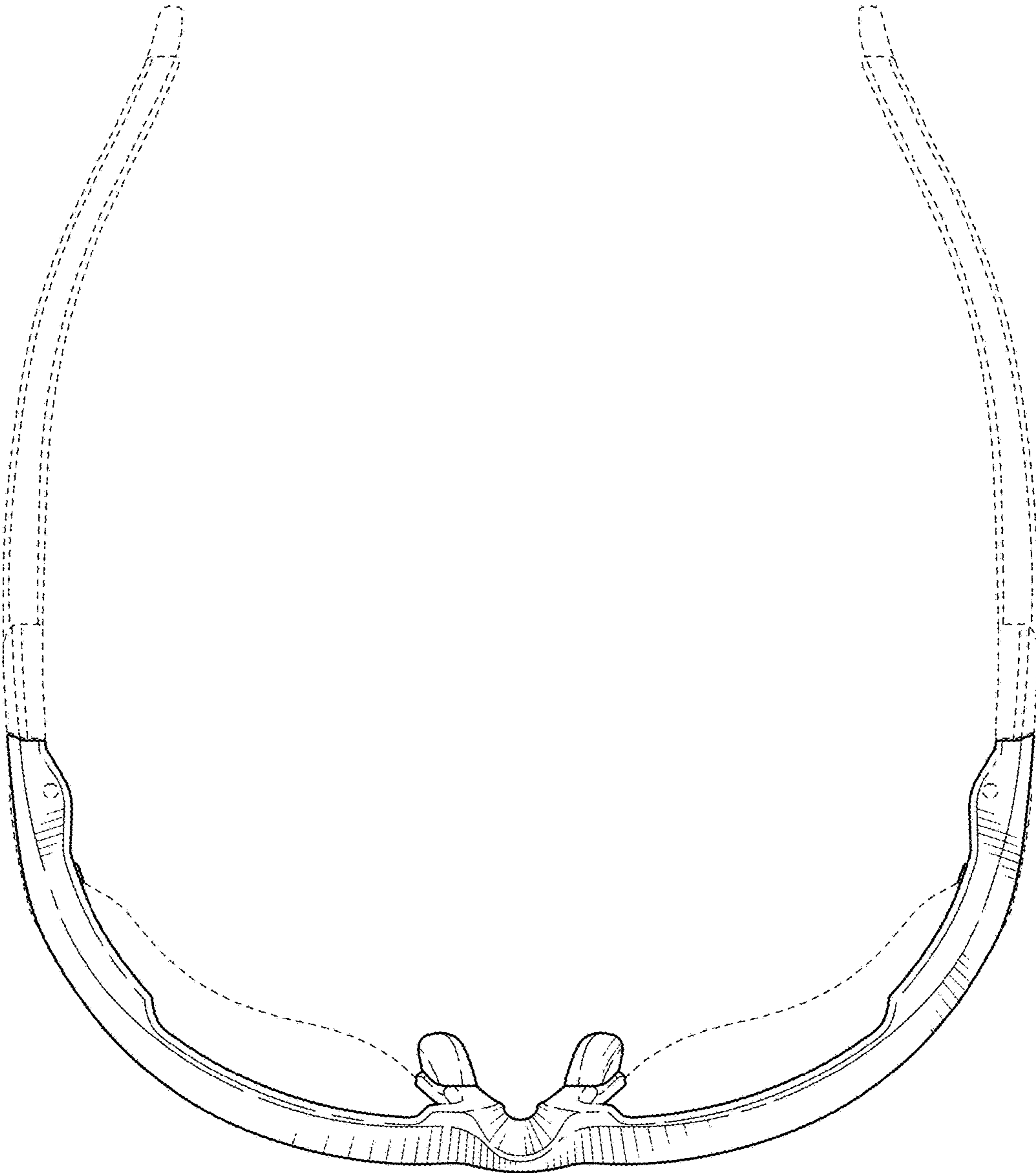

FIG. 5

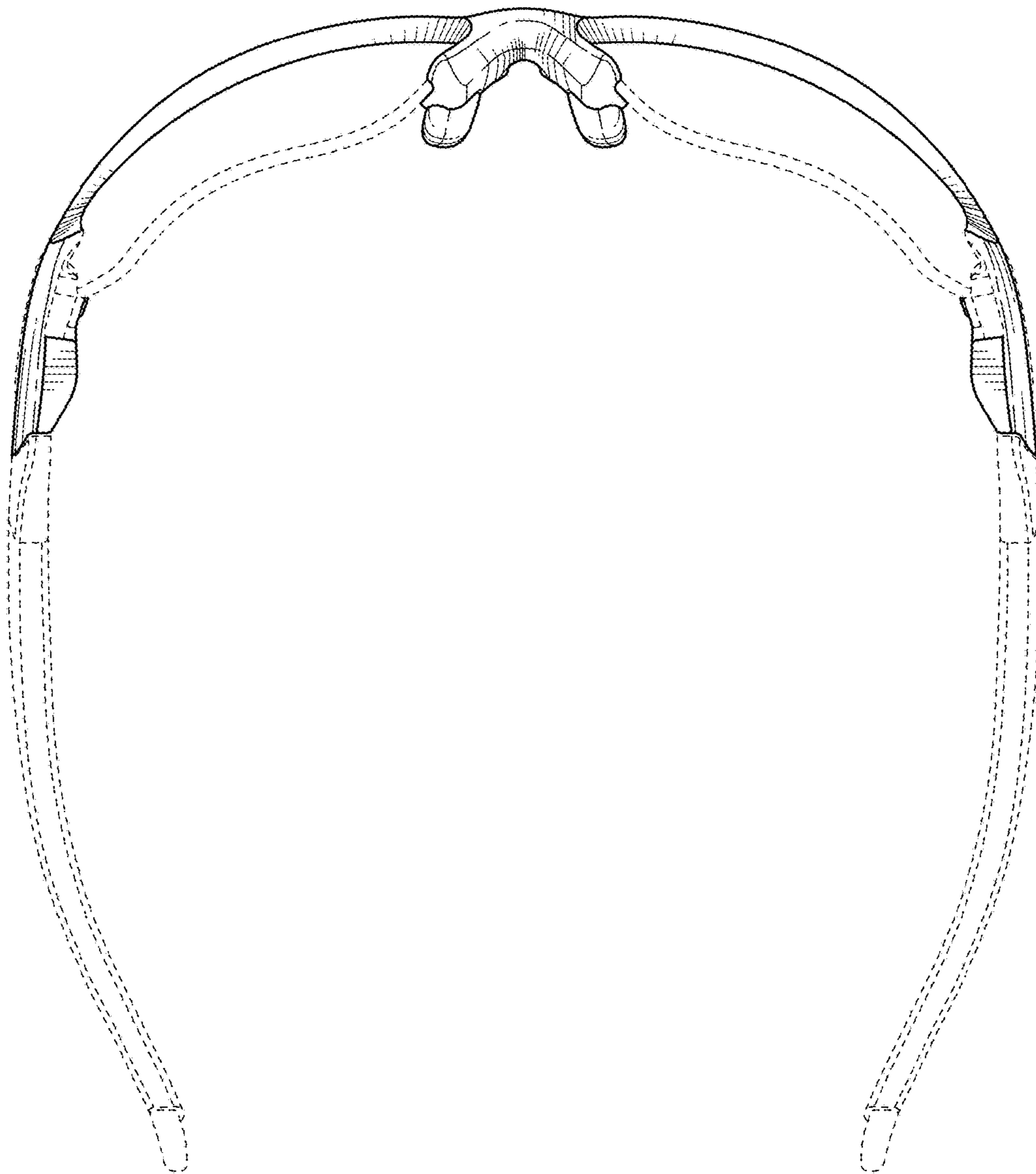

FIG. 6