



US00D810180S

(12) **United States Design Patent** (10) **Patent No.:** **US D810,180 S**
Gustaveson, II (45) **Date of Patent:** **** Feb. 13, 2018**

(54) **WEBCAM COVER**

FOREIGN PATENT DOCUMENTS

(71) Applicant: **SOL PALS, LLC**, Draper, UT (US)

CN 201114394 9/2008
CN 101980099 2/2011

(72) Inventor: **Ronald Glen Gustaveson, II**, Draper, UT (US)

(Continued)

(73) Assignee: **SOL PALS, LLC**, Draper, UT (US)

OTHER PUBLICATIONS

(**) Term: **15 Years**

PM:Webcam-Cover des Start-ups Privoo ab Juli im Handel. [online] published date Apr. 24, 2017. Retrieved on Apr. 29, 2017 from <URL: http://unternehmen-heute.de/news.php?newsid=426363>.*

(21) Appl. No.: **29/564,477**

(Continued)

(22) Filed: **May 13, 2016**

(51) **LOC (11) Cl.** **16-05**

(52) **U.S. Cl.**
USPC **D16/237**

(58) **Field of Classification Search**
USPC D16/134, 136, 210–219, 235, 237–245,
D16/250; D14/217, 229, 250–253
CPC G03B 17/02; G03B 17/04; G03B 17/14;
G03B 17/56; G03B 17/561–17/568;
G03B 7/00–7/002; G03B 7/02–7/04;
G03B 7/14; G03B 21/20–21/2066; F16M
11/02; F16M 11/04; F16M 11/20; F16M
11/40

See application file for complete search history.

Primary Examiner — Vy N Koenig

Assistant Examiner — Omeed Agilee

(74) *Attorney, Agent, or Firm* — Workman Nydegger

(57) **CLAIM**

The ornamental design for a webcam cover, as shown and described.

DESCRIPTION

FIG. 1 is a front perspective view of a webcam cover in a closed position to cover a webcam of an electronic device; FIG. 2 is a front perspective view of the webcam cover of FIG. 1 in an open position; FIG. 3 is a front elevational view thereof; FIG. 4 is a top plan view thereof; FIG. 5 is a bottom plan view thereof; FIG. 6 is a left elevational view; FIG. 7 is a right elevational view thereof; and, FIG. 8 is a rear perspective view thereof showing a magnetic that can be used to attach the webcam cover to an electronic device.

The broken lines shown in the drawings are included to illustrate environmental subject matter and form no part of the claimed design.

1 Claim, 4 Drawing Sheets

(56) **References Cited**

U.S. PATENT DOCUMENTS

D189,894 S	3/1961	Lang
D219,714 S	1/1971	Crestin-Billet
D342,262 S	12/1993	Hester
D371,508 S	7/1996	Sagol
D390,423 S	2/1998	Stivender
5,801,919 A	9/1998	Griencewic
D435,547 S	12/2000	Reed
D498,787 S	11/2004	Nelms
6,812,958 B1	11/2004	Silvester
D501,111 S	1/2005	Lan
7,061,536 B2	6/2006	Cha
D532,240 S	11/2006	Pressier
D532,640 S	11/2006	Pressier
7,239,806 B2	7/2007	Chen

(Continued)

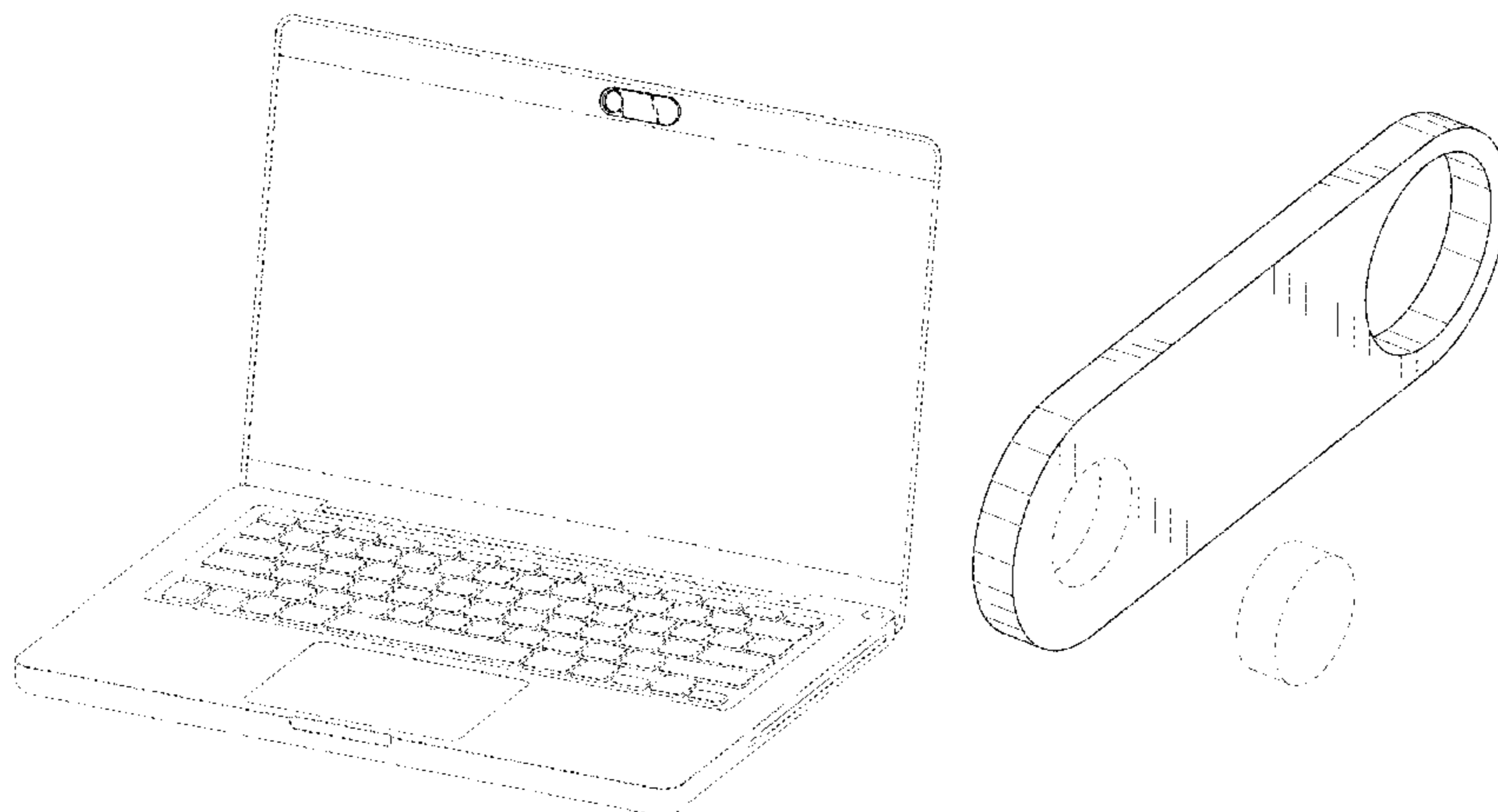

(56)

References Cited

U.S. PATENT DOCUMENTS

7,431,983	B2	10/2008	Amano	
7,435,018	B2	10/2008	Huang	
7,438,486	B2	10/2008	Ho	
7,563,040	B2	7/2009	Tsai	
7,581,893	B2 *	9/2009	Miramontes H04M 1/0264 396/448
D611,333	S	3/2010	Sanders	
7,677,815	B2	3/2010	Garcia	
D628,774	S	12/2010	Sykes	
D633,507	S *	3/2011	Nelson D14/484.1
D638,526	S	5/2011	Newman	
7,964,259	B2	6/2011	Koshu	
7,973,856	B2	7/2011	Lee	
D643,457	S	8/2011	DeLong	
D650,408	S	12/2011	Kim	
D659,403	S	5/2012	Lerman	
8,242,924	B2	8/2012	Huang	
D669,112	S	10/2012	Gustaveson	
8,471,956	B2	6/2013	Fortman	
8,496,390	B2	7/2013	Ohuchi	
D708,248	S	7/2014	Son	
D708,657	S	7/2014	Gustaveson	
8,780,205	B2	7/2014	Boutell	
D718,803	S	12/2014	Smith	
D720,382	S	12/2014	Szarawarski	
D721,396	S	1/2015	Gustaveson	
D740,773	S	10/2015	Bang	
D745,469	S	11/2015	Farnum	
9,197,850	B2	11/2015	Koberling	
9,305,538	B2	4/2016	Tyson	
D756,443	S	5/2016	Ju	
D759,645	S	6/2016	Penn	
D760,677	S	7/2016	Tsushima	
D763,843	S	8/2016	Gustaveson	
D764,474	S	8/2016	Penn	
9,465,276	B2	10/2016	Jonsson	
D782,562	S *	3/2017	Gustaveson, II D16/237
2005/0068423	A1	3/2005	Bear et al.	
2009/0252487	A1	10/2009	Matsumoto	
2009/0284635	A1	11/2009	Sung	
2010/0102979	A1	4/2010	Huang	
2011/0058255	A1	3/2011	Weiss	
2011/0115924	A1	5/2011	Yu	
2011/0182029	A1	7/2011	Wu	
2013/0088639	A1	4/2013	Mundt	
2014/0220269	A1 *	8/2014	Ogufere Ogufere	... B44C 5/005 428/34.1
2015/0015777	A1	1/2015	Osbourne	
2015/0059251	A1 *	3/2015	Rinner G06F 1/1656 49/465
2016/0105598	A1	4/2016	Zeira	
2016/0142594	A1	5/2016	Luttrell	
2016/0161830	A1 *	6/2016	Gonzalez Sanchez G06F 1/1686 396/448
2016/0323491	A1	11/2016	Al Marzouqi	
2017/0329206	A1	11/2017	Perkey	

FOREIGN PATENT DOCUMENTS

EM	003566330-0001	1/2017
ES	1076643	4/2012
ES	1077518	8/2012
JP	2001309003	11/2001
JP	2003289358	10/2003
JP	2004055630	2/2004
JP	2004072436	3/2004
JP	2004275434	10/2004
JP	2004309964	11/2004

JP	2005227445	8/2005
JP	2005275074	10/2005
JP	2005323049	11/2005
JP	2005345576	12/2005
JP	2009271407	11/2009
JP	2010210936	9/2010
KR	20040070899	8/2004
KR	20050015787	2/2005
KR	200405362	1/2006
KR	20060106527	10/2006
KR	100640798	11/2006
KR	20100003957	1/2010
KR	20100003957	4/2010
WO	2009137600	11/2009

OTHER PUBLICATIONS

Swivel Webcam Cover silver. [online] published date unknown. Retrieved on Apr. 29, 2017 from <URL: <http://www.intraco.nl/en/verkoop-andere-producten/swivel-webcam-cover-silver/>>.*

Early Spyslide 1-Pack Indiegogo Price. [online] published date unknown. Retrieved on Apr. 29, 2017 from <URL: <https://spy-fy.com/product/spyslide-webcam-cover-1-pack-indiegogo/?lang=en>>.*

Notice of Allowance for U.S. Appl. No. 29/385,909 dated Aug. 29, 2012.

"<http://webcamcovers.blogspot.com/2012/09/c-slide-webcam-cover-patent-reeives.html> Company Release: Sep. 18, 2012 Retrieved on: Feb. 26, 2014".

"[http://www.amazon.com/Webcam-Cover-Laptops-Pad-Devices/dp/B004ZOXS6/ref=sr_1_2?s=electronics&ie=UTF8\(qid=1393520771&sr=1-2&keywords=webcam+covers](http://www.amazon.com/Webcam-Cover-Laptops-Pad-Devices/dp/B004ZOXS6/ref=sr_1_2?s=electronics&ie=UTF8&qid=1393520771&sr=1-2&keywords=webcam+covers) Available on Amazon beginning May 3, 2011 Retrieved on: Feb. 26, 2014".

"http://www.ebay.com/itm/Webcam-Cover-also-known-as-webcam-shutter-webcam-shutter-fits-all-laptops-/160917145450#ht_2076wt_1358 On E-Bay beginning Jan. 26, 2012 Retrieved on: Feb. 26, 2014".

Notice of allowance for U.S. Appl. No. 29/433,900 dated Mar. 10, 2014.

Ex Parte Quayle Action for U.S. Appl. No. 29/473,247 dated Aug. 5, 2014.

Notice of Allowance for U.S. Appl. No. 29/520,343 dated Jun. 29, 2016.

Notice of Allowance for U.S. Appl. No. 29/548,560 dated Nov. 27, 2016.

Webcam Cover Black. [online] Published date unknown. Retrieved on Oct. 28, 2016 from <URL:<http://thewebcamcovers.com/shop/webcamcover-black/>>.

"Screen Cleaner Pad for Mobile Phones AllAccessories", Publish Date: Sep. 12, 2011, Access Date: Sep. 26, 2017 from <<https://www.youtube.com/watch?v=7TFoI-ceBUw>>.

"DigiClean Plus Microfiber Screen Cleaners", Publish Date: Aug. 30, 2011, Access Date: Sep. 26, 2017, from <<https://www.youtube.com/watch?v=-LWFp8Z-fzA>>.

"DigiClean Plus Mobile Phone Screen Cleaner / Wipe Stickers", Publish Date: Jun. 29, 2012, Access Date: Sep. 26, 2017, from <<https://www.youtube.com/watch?v=EHK9UWFUGa0>>.

Office Action in U.S. Appl. No. 15/433,151 dated Jul. 11, 2017.

Ex Parte Quayle Action for U.S. Appl. No. 29/585,474 mailed on Jul. 13, 2017.

Ex Parte Quayle Action for U.S. Appl. No. 29/567,669 mailed on Jul. 12, 2017.

Webcamcover 2.0 black. [online] Published date unknown. Retrieved on Jun. 12, 2017 from <URL:<https://thewebcamcovers.com/product/webcamcover-2-0-black/>>.

* cited by examiner

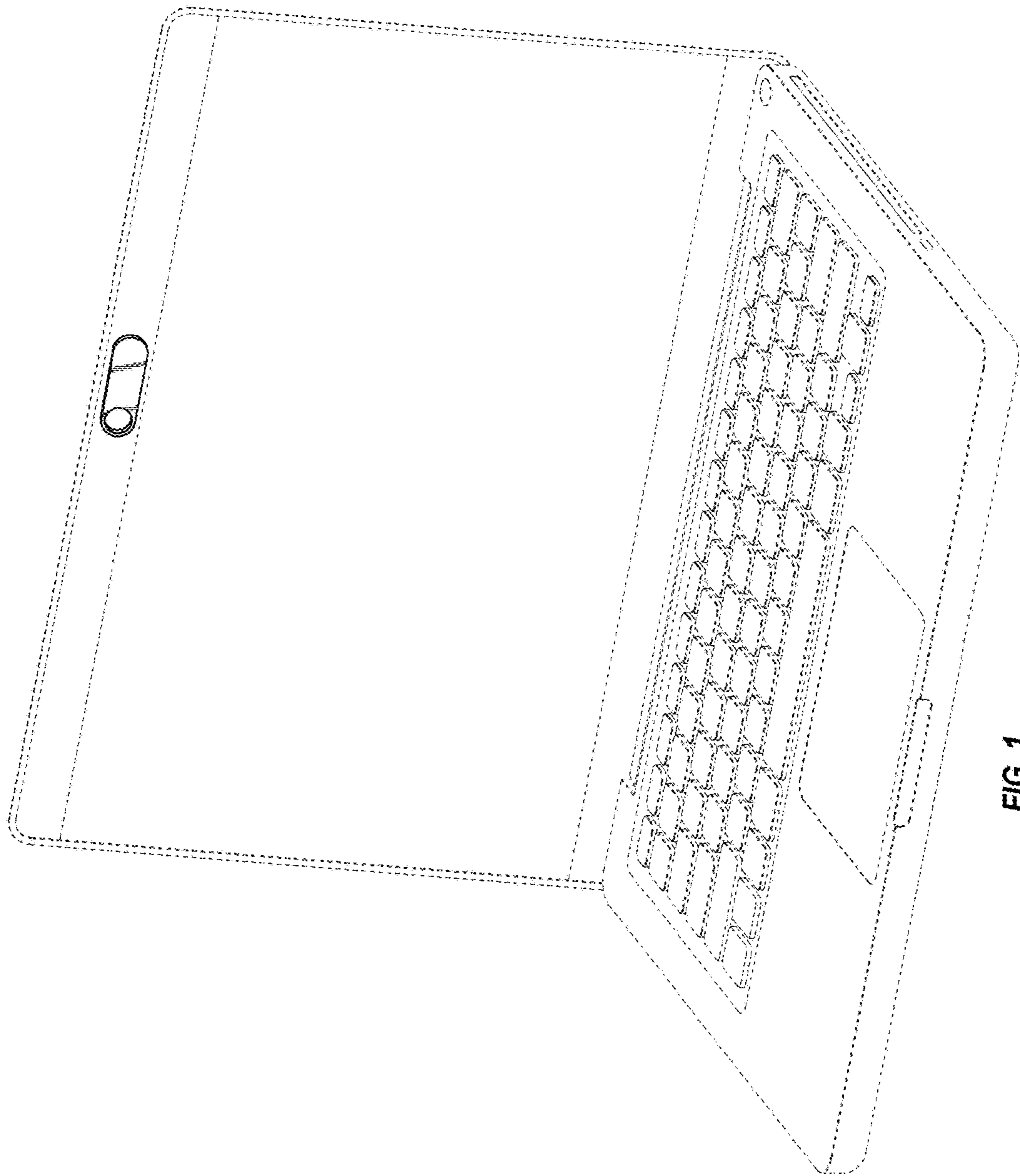

FIG. 1

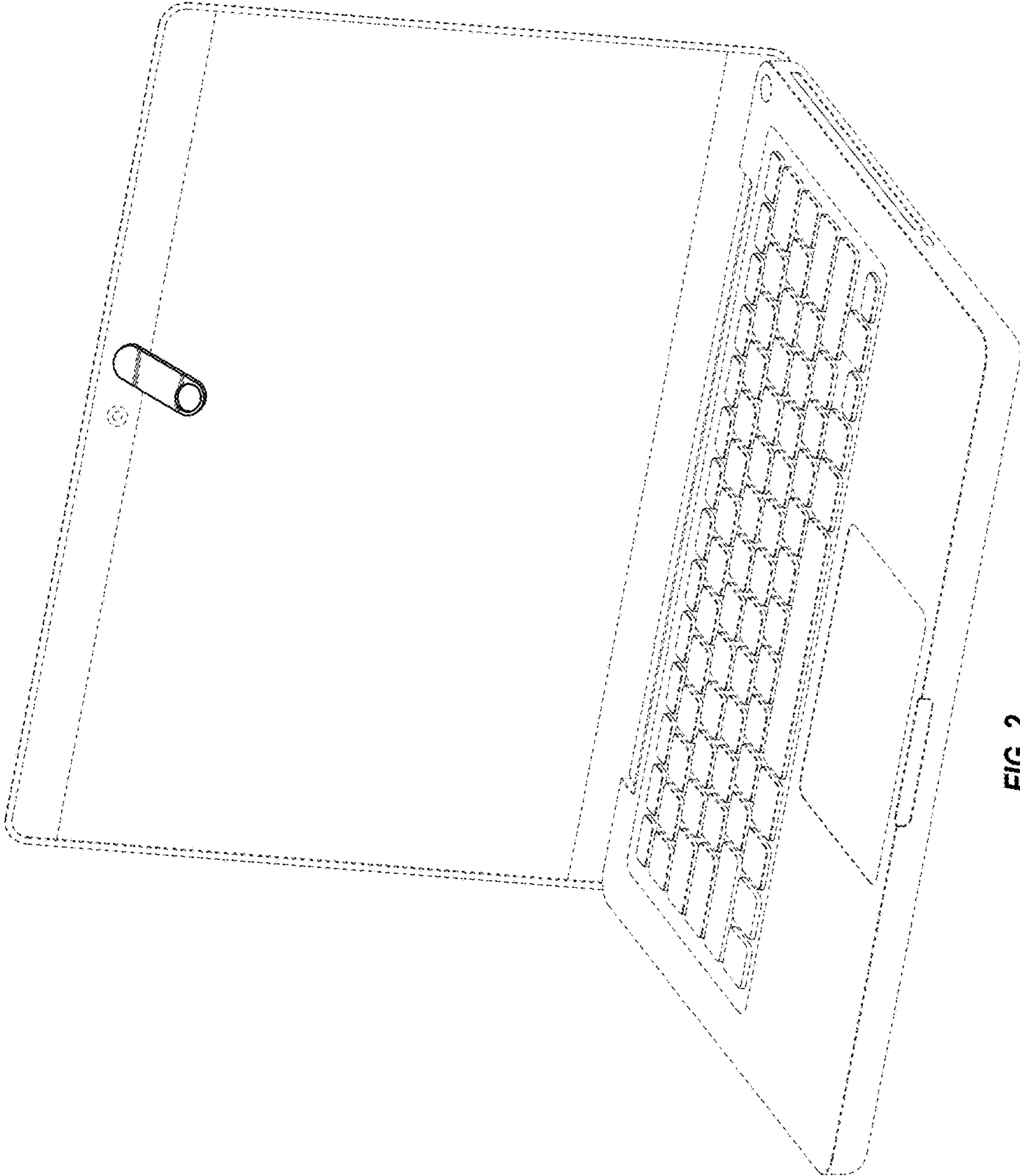

FIG. 2

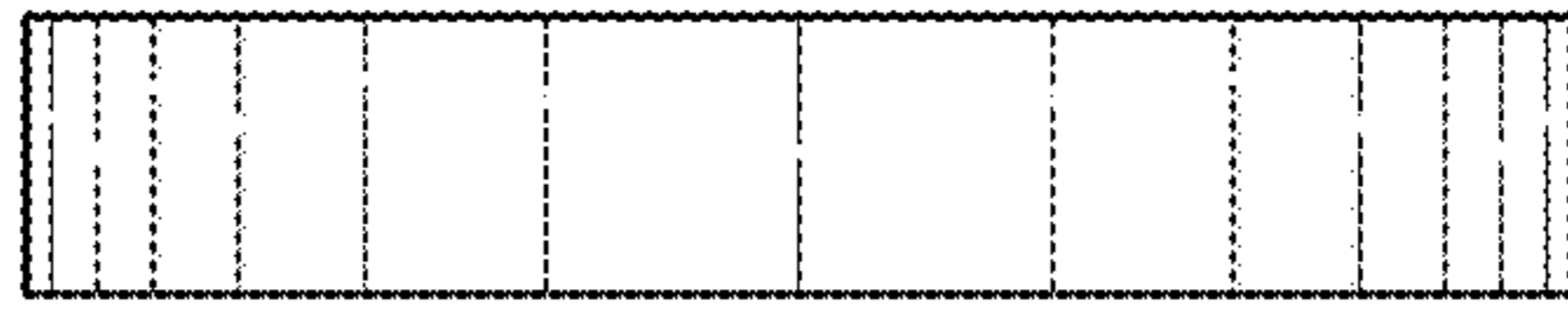

FIG. 6

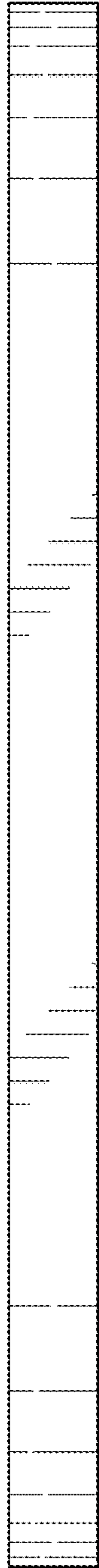

FIG. 5

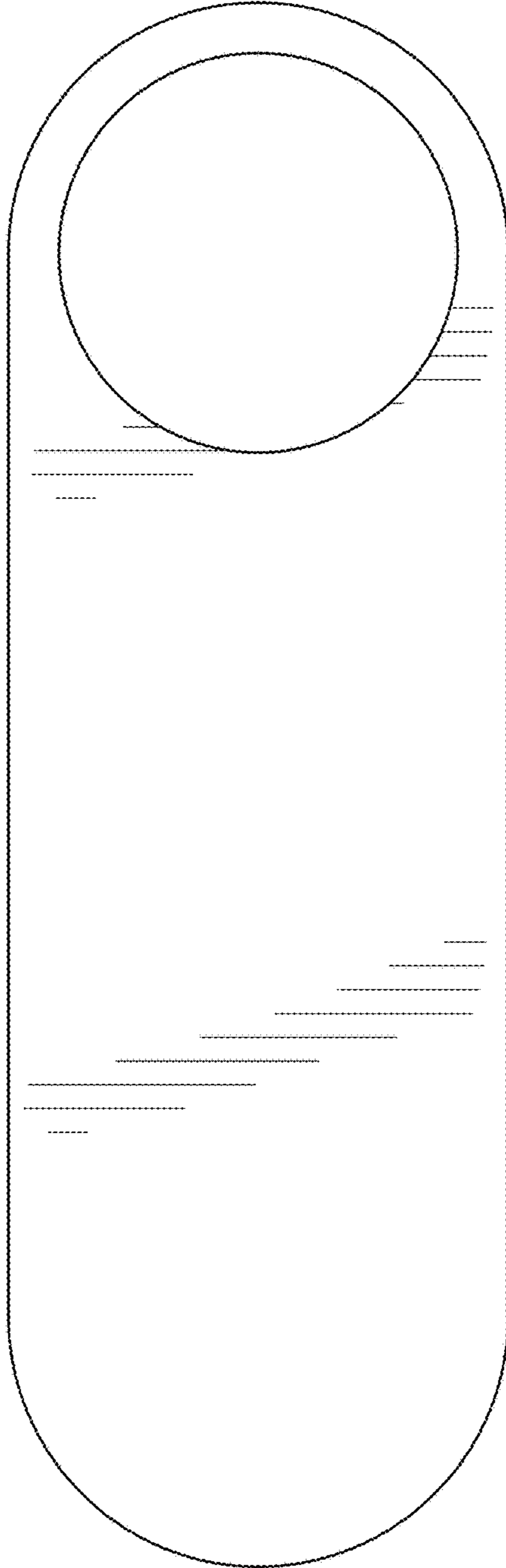

FIG. 3

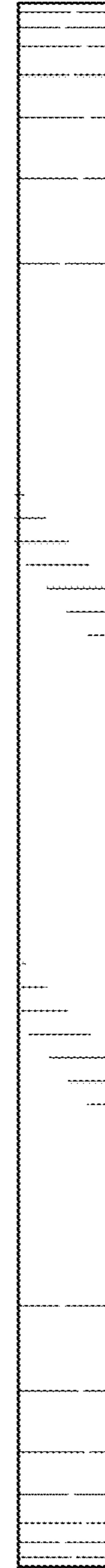

FIG. 4

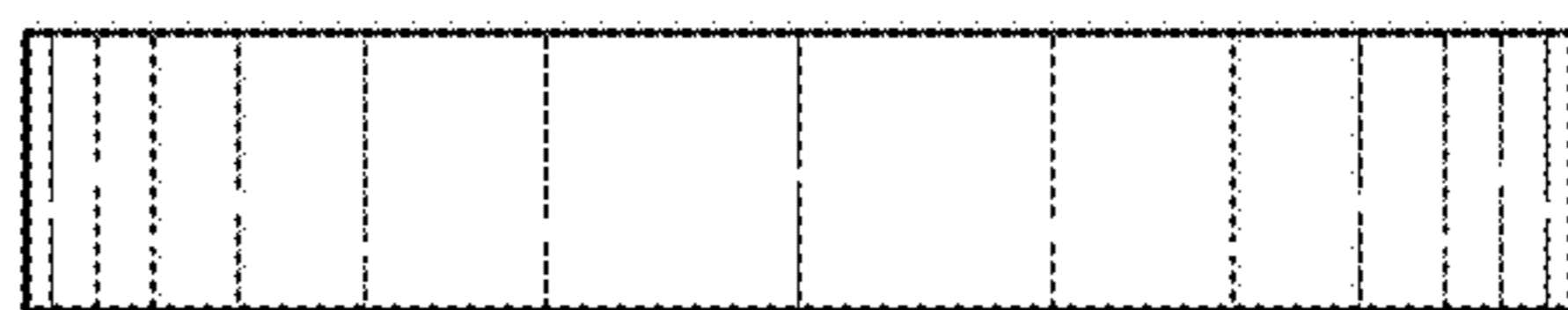

FIG. 7

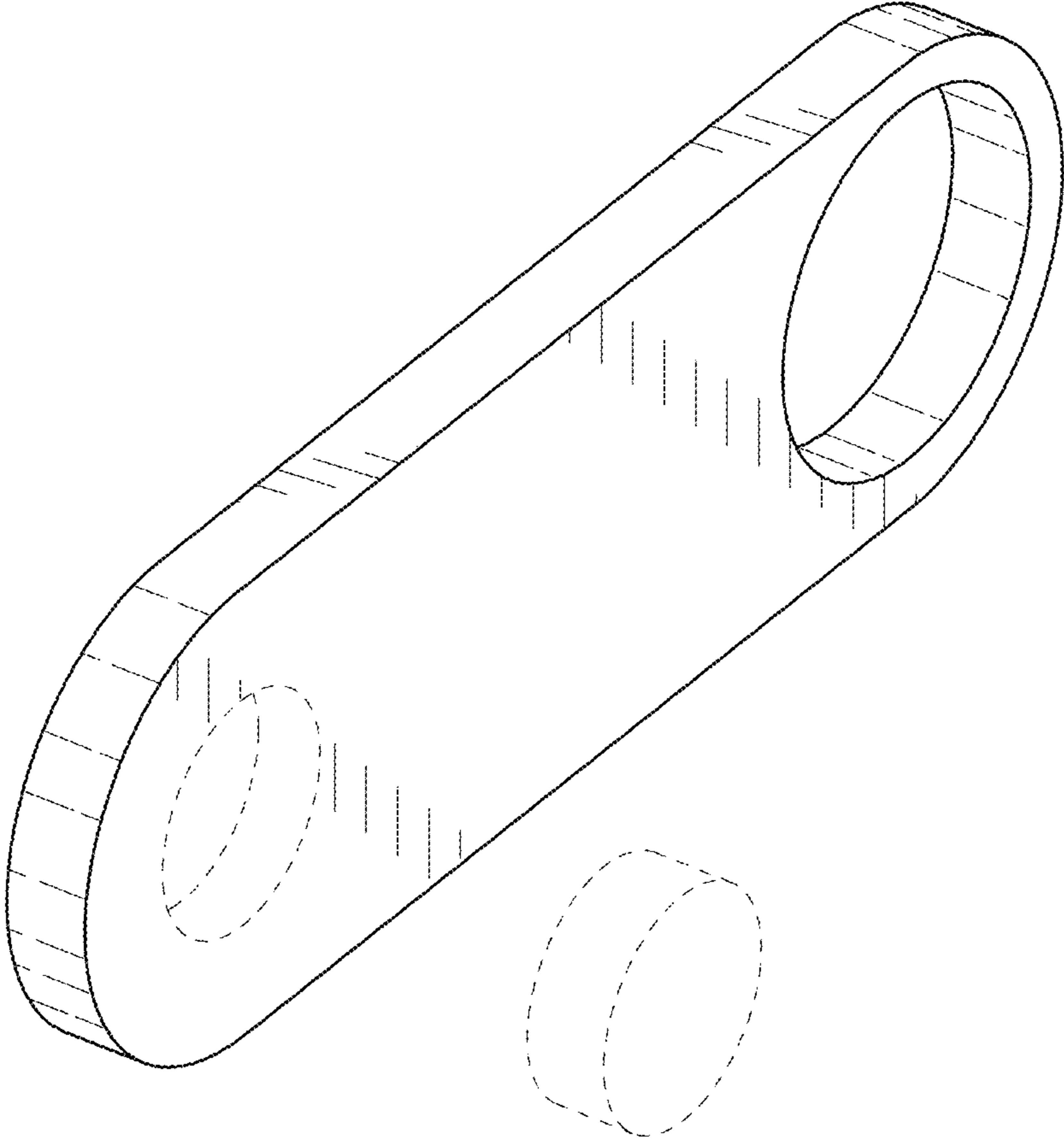

FIG. 8