



US00D810152S

(12) **United States Design Patent** (10) **Patent No.:** **US D810,152 S**
Yamada et al. (45) **Date of Patent:** **** Feb. 13, 2018**

(54) **LATCH HANDLE FOR FREEZER**

(71) Applicant: **PANASONIC HEALTHCARE HOLDINGS CO., LTD.**, Minato-ku, Tokyo (JP)

(72) Inventors: **Fumio Yamada**, Gunma (JP); **Akihiro Mochizuki**, Gunma (JP); **Tadashi Okada**, Saitama (JP)

(73) Assignee: **PANASONIC HEALTHCARE HOLDINGS CO., LTD.**, Tokyo (JP)

(**) Term: **15 Years**

(21) Appl. No.: **29/570,519**

(22) Filed: **Jul. 8, 2016**

(30) **Foreign Application Priority Data**

Jan. 20, 2016 (JP) 2016-000980

(51) **LOC (11) Cl.** **15-07**

(52) **U.S. Cl.**
USPC **D15/89**

(58) **Field of Classification Search**
USPC D15/79-91; D8/331, 330, 336, 339, 343, D8/349, 302, 354, 499
CPC E05B 1/00; E05B 1/0015; A47B 95/02; F25D 23/028; F25D 27/00; F25D 27/005; F25D 23/062; F25D 23/065; F25D 2323/021; F25D 2323/024; F25D 2327/001; F25D 23/067; F25D 2400/40; F25D 25/024; F25D 11/00; F25D 11/003; F25D 15/00; F25D 17/02; F25D 21/04; F25D 2201/12; F25D 2303/081; F25D 2323/02; F25D 2323/023; F25D 2323/06; F25D 2323/061; F25D 2323/121; F25D 2325/021; F25D 2325/022; F25D 2331/803; F25D 2331/805; F25D 23/006; F25D 23/02; F25D 23/06; F25D 23/061; F25D 23/066; F25D

(Continued)

(56) **References Cited**

U.S. PATENT DOCUMENTS

D436,830 S * 1/2001 Nesseth D8/302
D491,441 S 6/2004 Sato et al.
(Continued)

FOREIGN PATENT DOCUMENTS

JP D1183156 S 8/2003
JP D1183159 S 8/2003
JP D1261471 S 1/2006

Primary Examiner — Ian Simmons
Assistant Examiner — Khawaja Anwar
(74) *Attorney, Agent, or Firm* — Brinks Gilson & Lione

(57) **CLAIM**

We claim the ornamental design for a latch handle for freezer, as shown and described.

DESCRIPTION

FIG. 1 is a front, top, and right side perspective view of a latch handle for freezer of the present invention; FIG. 2 is a front, top, and left side perspective view thereof; FIG. 3 is a front, bottom, and right side perspective view thereof; FIG. 4 is a rear, bottom, and right side perspective view thereof; FIG. 5 is a front view thereof; FIG. 6 is a rear view thereof; FIG. 7 is a left side view thereof; FIG. 8 is a right side view thereof; FIG. 9 is a top view thereof; FIG. 10 is a bottom view thereof; and, FIG. 11 is a perspective view showing a state the latch handle is equipped with the freezer. The broken lines shown are included for the purpose of illustrating the unclaimed portions of the freezer and form no part of the claimed design.

1 Claim, 9 Drawing Sheets

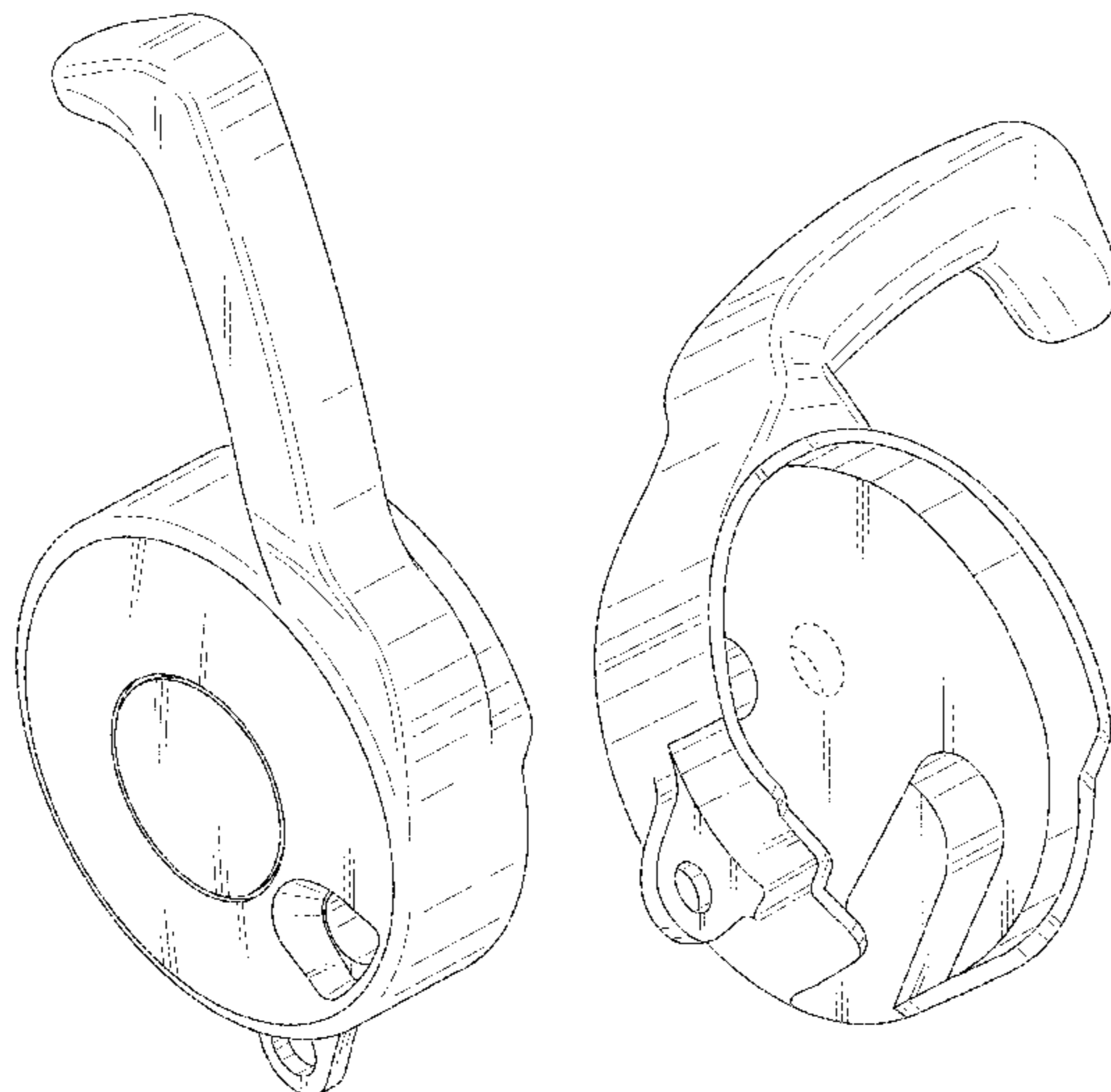

(58) **Field of Classification Search**

CPC 23/068; F25D 23/08; F25D 23/126; F25D
2400/04; F25D 2400/28; F25D 2400/32;
F25D 2400/36; F25D 25/02; F25D
25/025; F25D 2700/02; F25D 2700/04;
F25D 2700/06; F25D 2700/16; F25D
29/00; F25D 29/008; F25D 31/002; F25D
31/005; F25D 31/007; F25D 3/08

See application file for complete search history.

(56) **References Cited**

U.S. PATENT DOCUMENTS

D496,372	S	*	9/2004	Sato	D15/81
D521,536	S	*	5/2006	Reese	D15/89
D529,367	S	*	10/2006	Zweibohmer	D8/301
D532,799	S		11/2006	Sato et al.		
D652,119	S	*	1/2012	Reid	D23/252
D709,351	S	*	7/2014	Le	D8/331
D717,152	S	*	11/2014	Weinerman	D8/331
D793,838	S	*	8/2017	Le	D8/302
D794,093	S	*	8/2017	Yoon	D15/89
D794,411	S	*	8/2017	Le	D8/302

* cited by examiner

Fig. 1

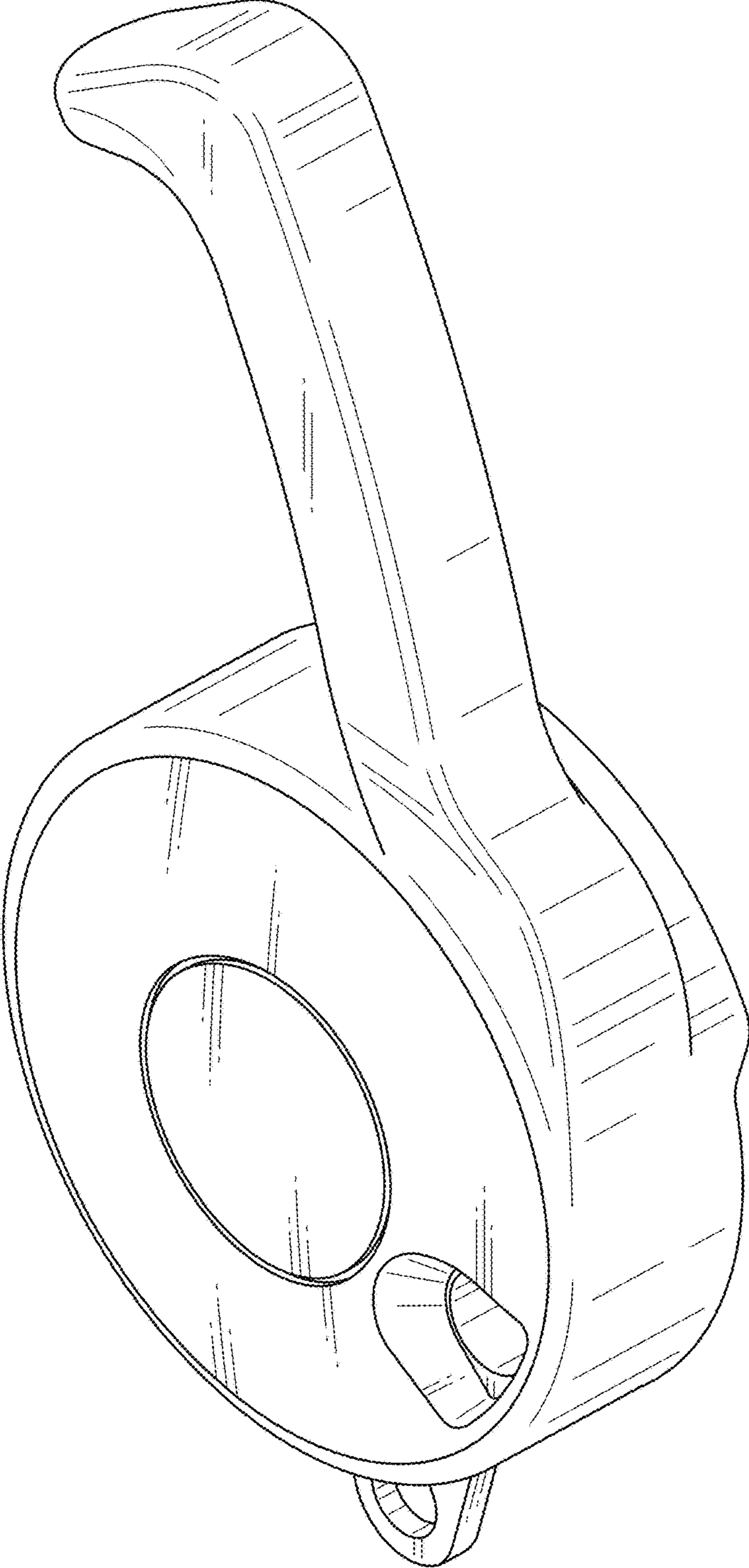

Fig. 2

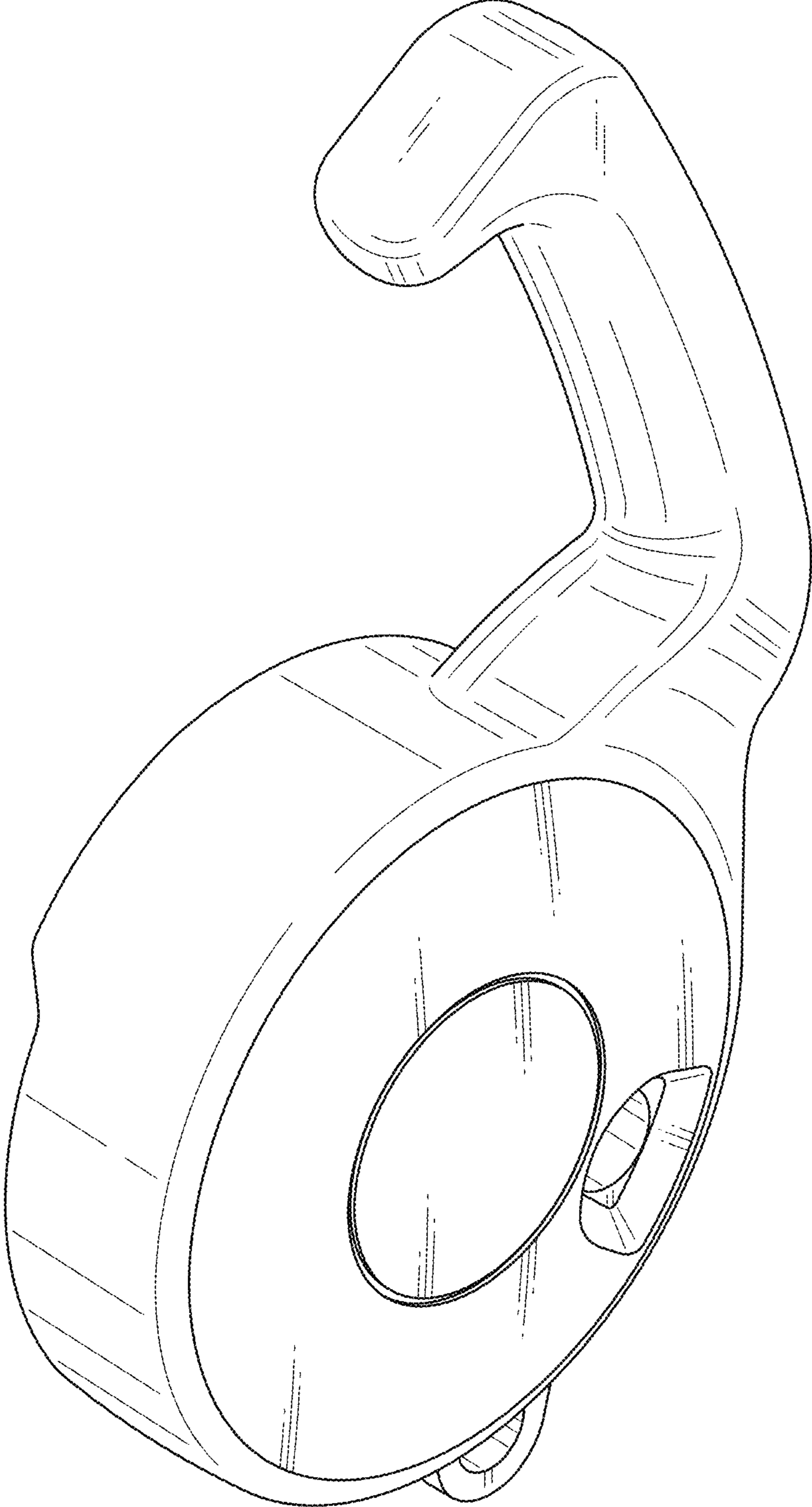

Fig. 3

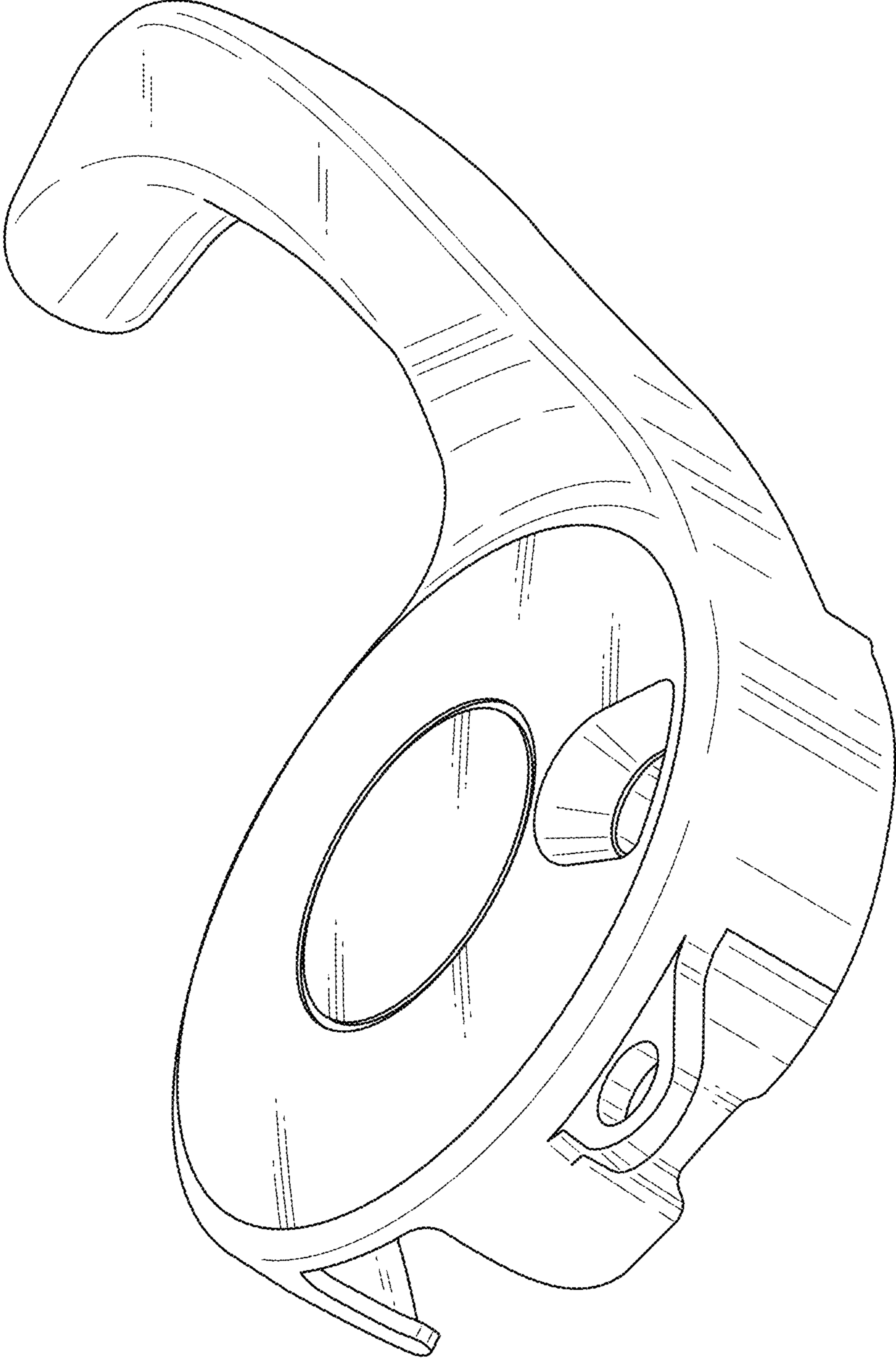

Fig. 4

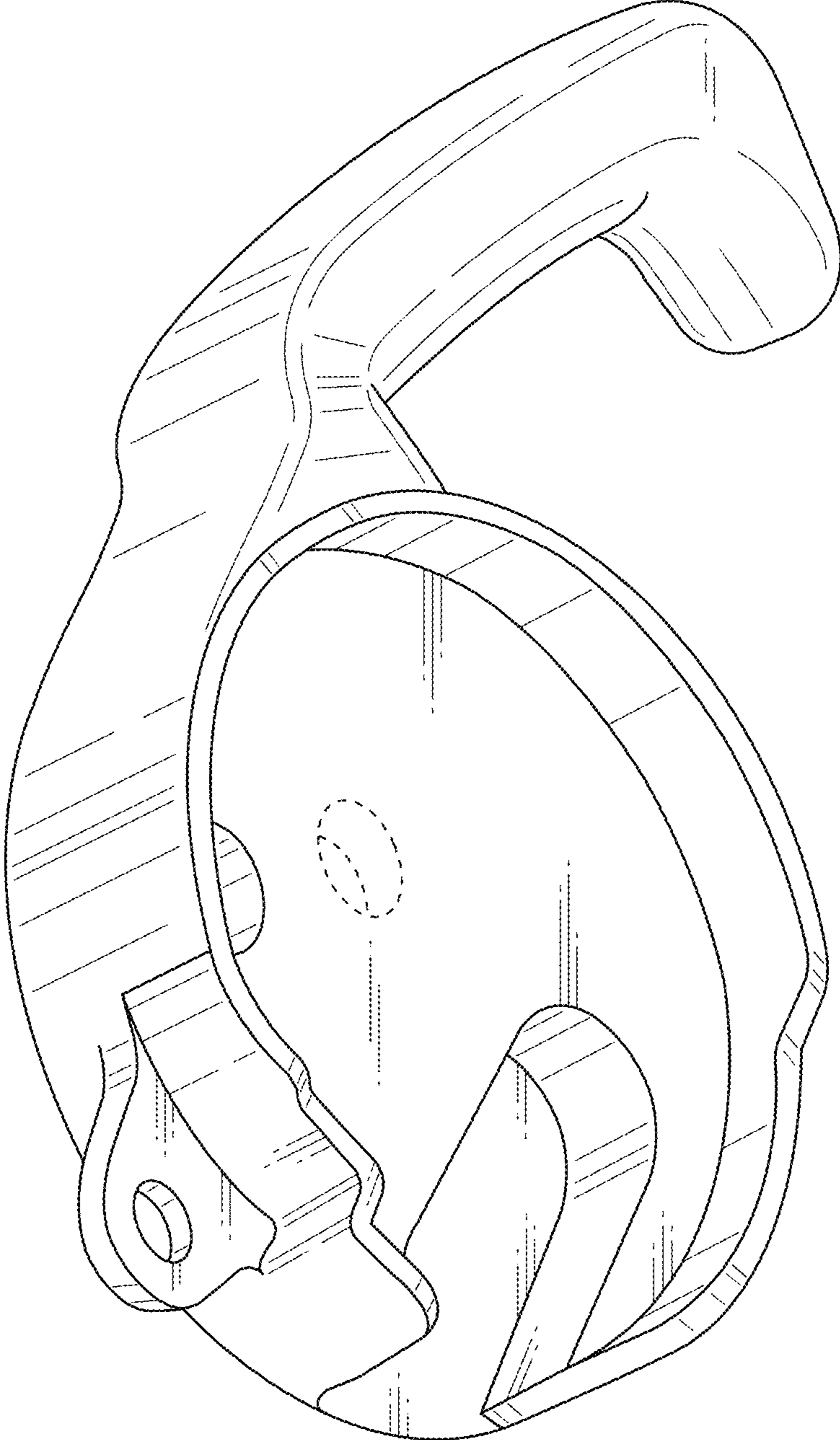

Fig. 5

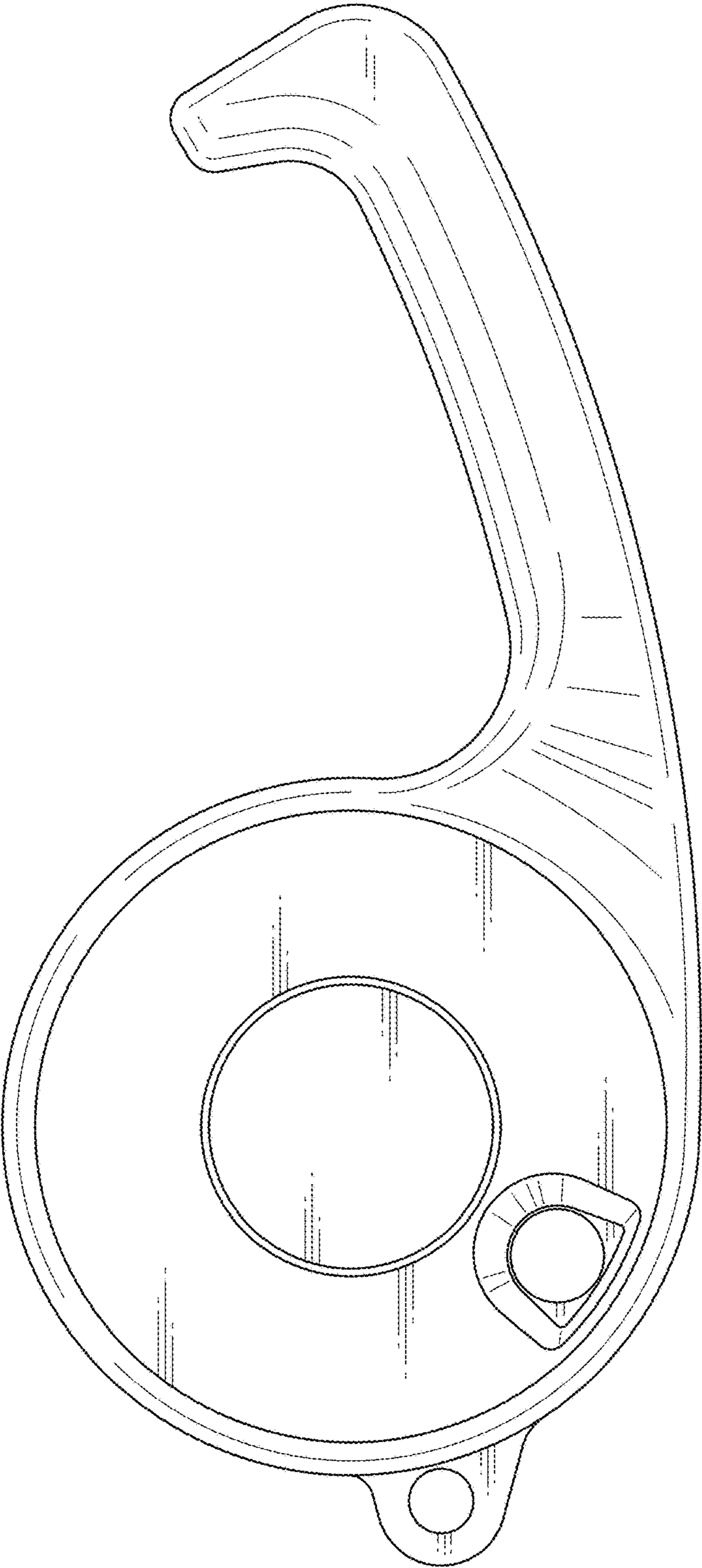

Fig. 6

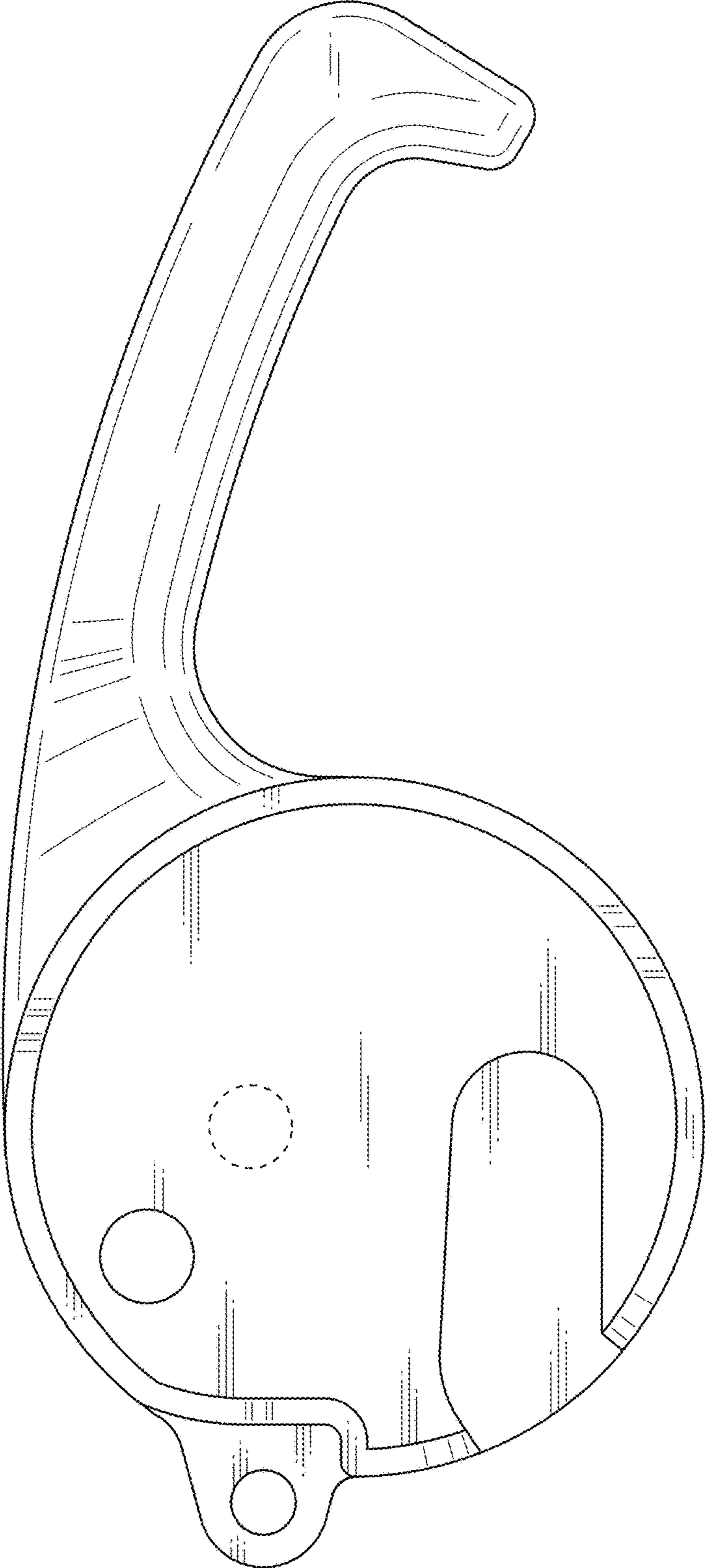

Fig. 7

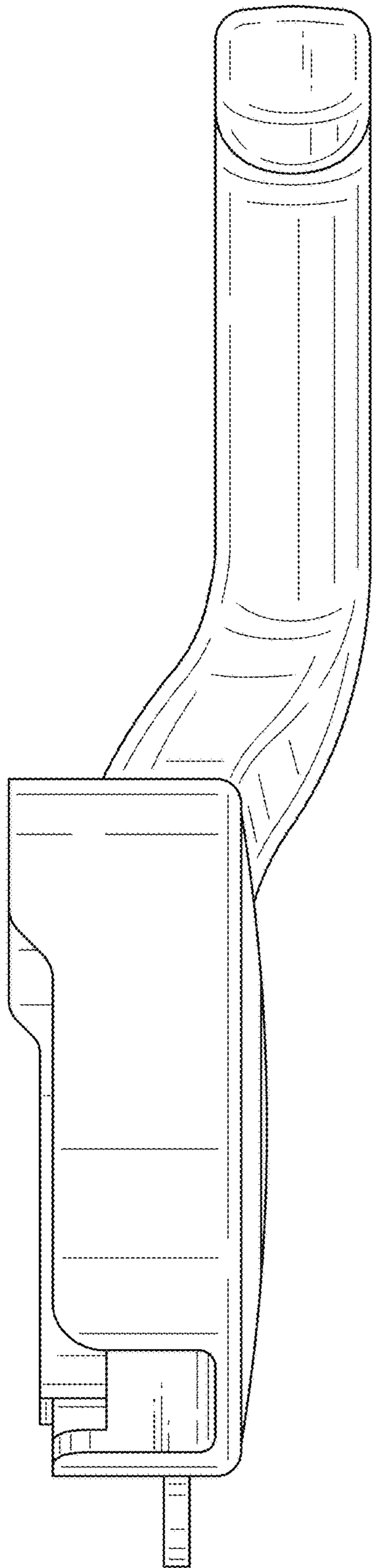

Fig. 8

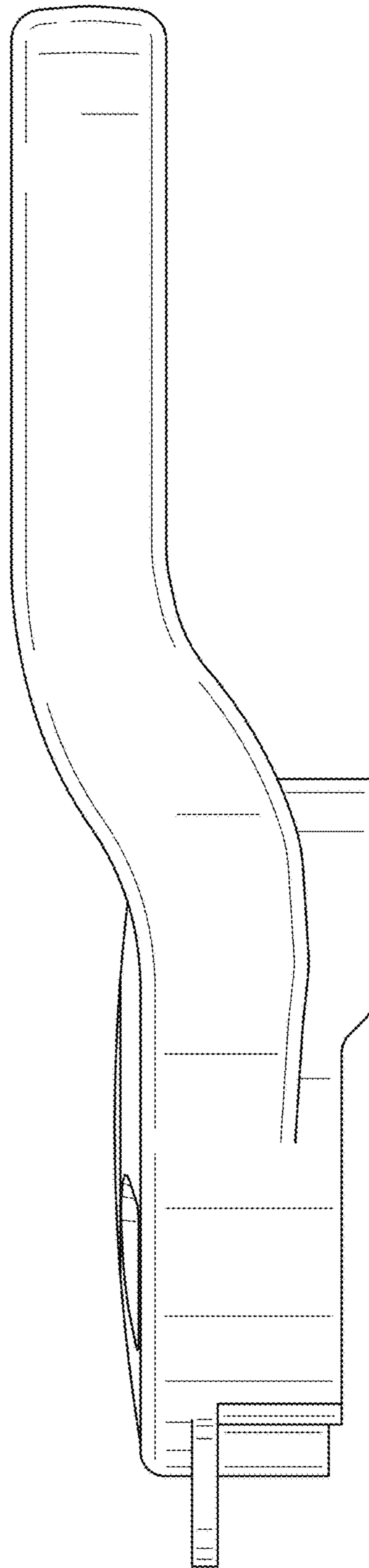

Fig. 9

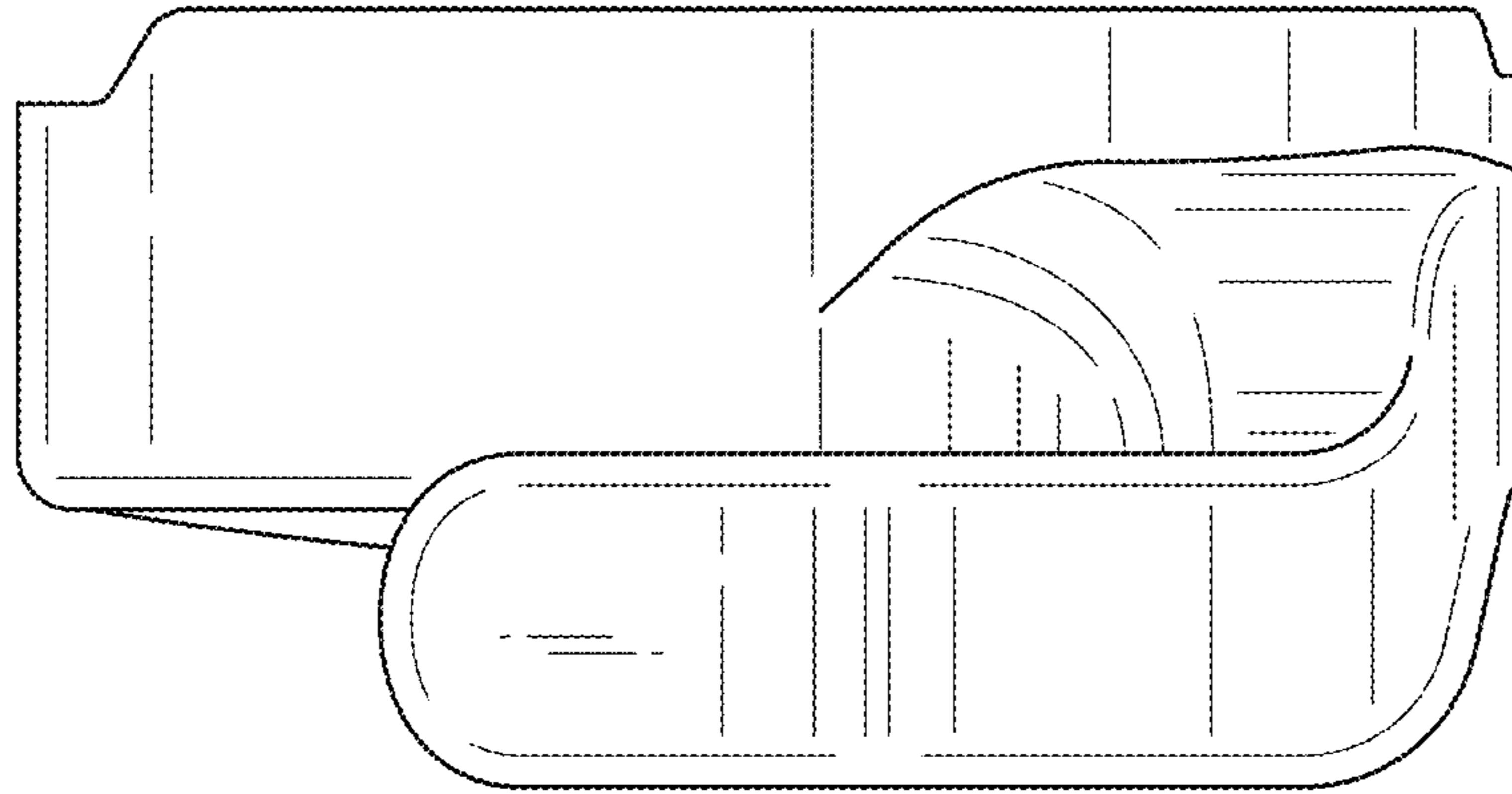

Fig. 10

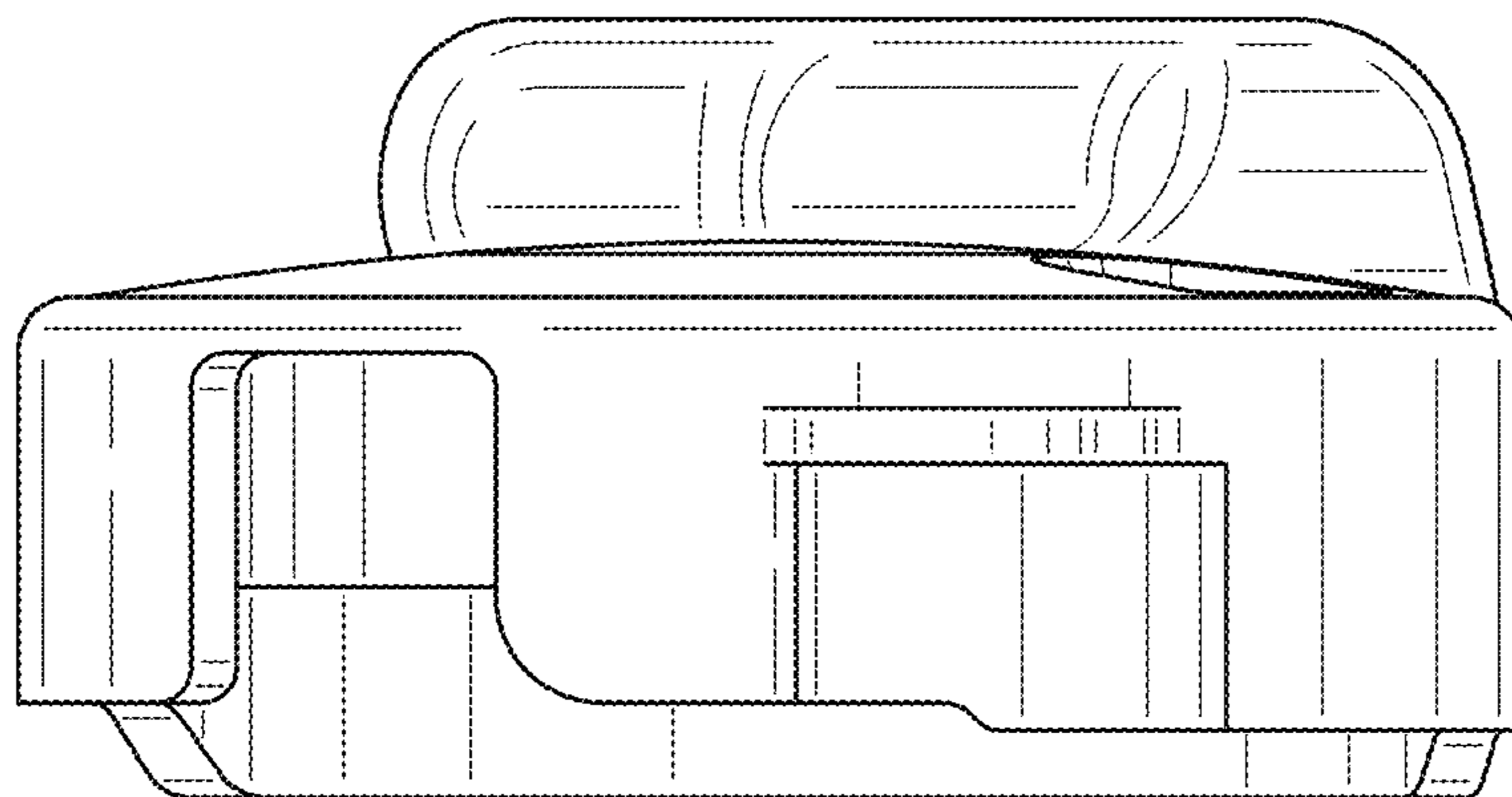

Fig. 11

