

US00D810056S

(12) **United States Design Patent** (10) **Patent No.:** **US D810,056 S**  
**Chang et al.** (45) **Date of Patent:** **\*\* Feb. 13, 2018**

- (54) **ANTENNA**
- (71) Applicant: **Airgain, Incorporated**, San Diego, CA (US)
- (72) Inventors: **Wei Chang**, Zhang Jia Gang (CN); **Bei Zheng**, Zhang Jia Gang (CN); **Simon Yang**, Carlsbad, CA (US)
- (73) Assignee: **Airgain Incorporated**, San Diego, CA (US)
- (\*\*) Term: **15 Years**
- (21) Appl. No.: **29/533,299**
- (22) Filed: **Jul. 15, 2015**
- (51) **LOC (11) Cl.** ..... **14-03**
- (52) **U.S. Cl.**  
USPC ..... **D14/230**
- (58) **Field of Classification Search**  
USPC ..... D14/230, 231, 232, 233, 234, 235, 236, D14/237, 238, 138, 299, 358; D12/42, D12/43  
CPC ..... H01Q 7/00; H01Q 13/10; H01Q 9/285; H01Q 19/30; H01Q 19/12; H01Q 1/38; H01Q 13/36; H01Q 1/42; H01Q 1/242; H01Q 1/243; H01Q 1/2266  
See application file for complete search history.

- 7,405,704 B1 8/2008 Lin et al.
- D585,054 S \* 1/2009 Hsiao ..... D14/230
- 7,477,195 B2 1/2009 Vance
- D592,195 S 5/2009 Wu et al.
- 7,570,215 B2 8/2009 Abramov et al.
- D599,334 S 9/2009 Chiang
- D606,053 S 12/2009 Wu et al.
- D607,442 S 1/2010 Su et al.
- D608,769 S 1/2010 Bufe
- D612,368 S 3/2010 Yang et al.
- 7,705,783 B2 4/2010 Rao et al.
- 7,729,662 B2 6/2010 Abramov et al.
- D621,819 S 8/2010 Tsai et al.
- 7,843,390 B2 11/2010 Liu
- D633,483 S 3/2011 Su et al.
- D635,127 S 3/2011 Tsai et al.
- 7,907,971 B2 3/2011 Salo et al.
- D635,560 S 4/2011 Tsai et al.
- D635,963 S 4/2011 Podduturi
- D635,964 S \* 4/2011 Podduturi ..... D14/230

(Continued)

*Primary Examiner* — Karen S Acker  
*Assistant Examiner* — Jerry Shiu-an-Hua Hsu  
(74) *Attorney, Agent, or Firm* — Clause Eight IPS; Michael Catania

(57) **CLAIM**

The ornamental design for an antenna, as shown and described.

**DESCRIPTION**

FIG. 1 is a front elevation view of an antenna; FIG. 2 is a side elevation view thereof; FIG. 3 is a rear elevation view thereof; FIG. 4 is top perspective view thereof; FIG. 5 is a front elevation view of the antenna of FIG. 1, with environmental matter removed; and, FIG. 6 is a rear elevation thereof. The broken lines showing a base in FIGS. 1-4 represent environment and form no part of the claimed design.

**1 Claim, 2 Drawing Sheets**

(56) **References Cited**  
U.S. PATENT DOCUMENTS

- 7,061,437 B2 6/2006 Lin et al.
- 7,148,849 B2 12/2006 Lin
- 7,215,296 B2 5/2007 Abramov et al.
- D546,821 S 7/2007 Oliver
- D549,696 S 8/2007 Oshima et al.
- 7,333,067 B2 2/2008 Hung et al.
- 7,336,959 B2 2/2008 Khitrik et al.
- D572,243 S \* 7/2008 Lin ..... D14/230
- D573,589 S 7/2008 Montgomery et al.

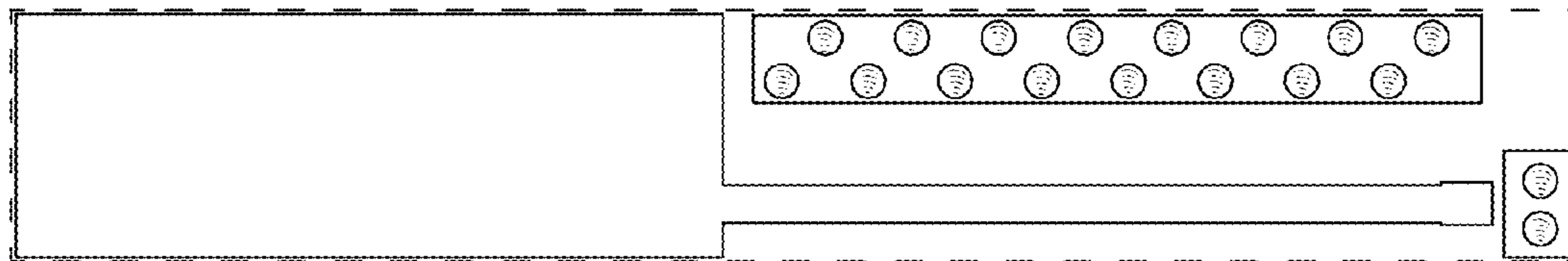

(56)

References Cited

U.S. PATENT DOCUMENTS

D635,965 S	4/2011	Mi et al.	D706,750 S	6/2014	Bringuir
D636,382 S	4/2011	Podduturi	D706,751 S	6/2014	Chang et al.
7,965,242 B2	6/2011	Abramov et al.	D708,602 S	7/2014	Gosalia et al.
D649,962 S	12/2011	Tseng et al.	D709,053 S	7/2014	Chang et al.
D651,198 S	12/2011	Mi et al.	D710,832 S	8/2014	Yang
D654,059 S	2/2012	Mi et al.	D710,833 S	8/2014	Zheng et al.
D654,060 S	2/2012	Ko et al.	8,854,265 B1	10/2014	Yang et al.
D658,639 S	5/2012	Huang et al.	D716,775 S	11/2014	Bidermann
D659,129 S	5/2012	Mi et al.	D750,049 S *	2/2016	Podduturi ..... D14/230
D659,685 S	5/2012	Huang et al.	D750,050 S *	2/2016	Podduturi ..... D14/230
D659,688 S	5/2012	Huang et al.	D756,336 S *	5/2016	Podduturi ..... D14/230
8,175,036 B2	5/2012	Visuri et al.	D766,883 S *	9/2016	Yang ..... D14/230
8,184,601 B2	5/2012	Abramov et al.	D767,544 S *	9/2016	Yang ..... D14/230
D662,916 S	7/2012	Huang et al.	D771,601 S *	11/2016	Chen ..... D14/230
8,248,970 B2	8/2012	Abramov et al.	D776,643 S *	1/2017	He ..... D14/230
D671,097 S	11/2012	Mi et al.	2002/0003499 A1	1/2002	Kouarn et al.
8,310,402 B2	11/2012	Yang	2004/0222936 A1 *	11/2004	Hung ..... H01Q 1/38 343/795
D676,429 S	2/2013	Gosalia et al.	2005/0073462 A1	4/2005	Lin et al.
D678,255 S	3/2013	Ko et al.	2005/0190108 A1	9/2005	Lin et al.
8,423,084 B2	4/2013	Abramov et al.	2006/0208900 A1	9/2006	Tavassoli Hozouri
D684,565 S	6/2013	Wei	2007/0030203 A1	2/2007	Tsai et al.
D685,352 S	7/2013	Wei	2008/0150829 A1	6/2008	Lin et al.
D685,772 S	7/2013	Zheng et al.	2009/0002244 A1	1/2009	Woo
D686,600 S	7/2013	Yang	2009/0058739 A1	3/2009	Konishi
D689,474 S *	9/2013	Yang ..... D14/230	2009/0135072 A1	5/2009	Ke et al.
D692,870 S	11/2013	He	2009/0262028 A1	10/2009	Murnbru et al.
D694,738 S	12/2013	Yang	2010/0079350 A1 *	4/2010	Lai ..... H01Q 1/243 343/843
D695,279 S	12/2013	Yang et al.	2010/0188297 A1	7/2010	Chen et al.
D695,280 S	12/2013	Yang et al.	2010/0309067 A1	12/2010	Tsou et al.
D703,195 S	4/2014	Zheng	2011/0006950 A1	1/2011	Park et al.
D703,196 S	4/2014	Zheng	2012/0038514 A1	2/2012	Bang
D706,247 S	6/2014	Zheng et al.	2012/0229348 A1	9/2012	Chiang
			2012/0242546 A1	9/2012	Hu et al.

\* cited by examiner

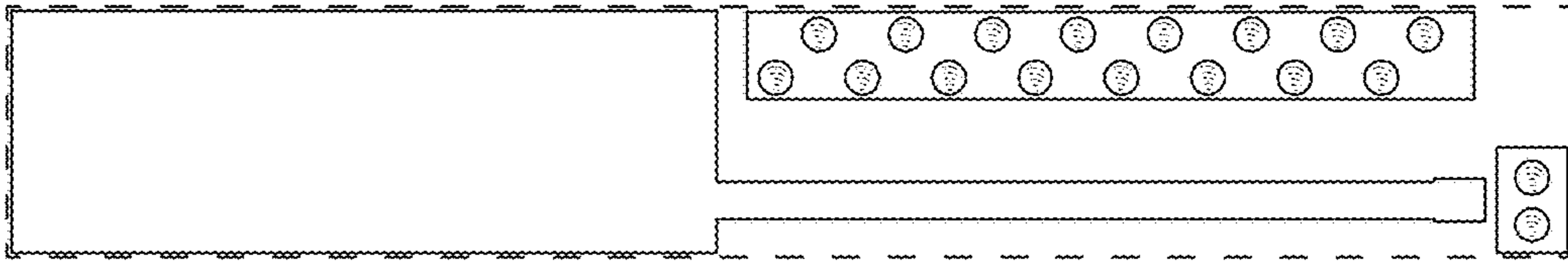

FIG. 1

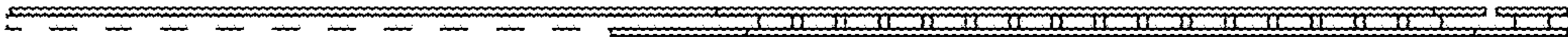

FIG. 2

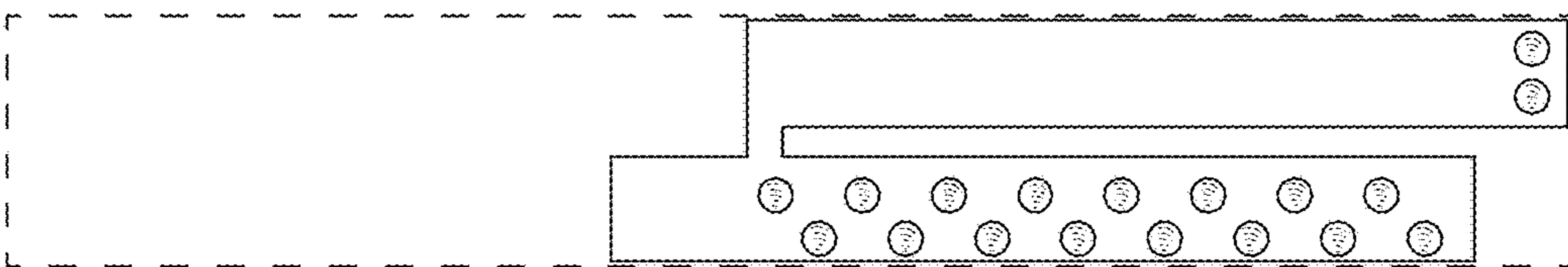

FIG. 3

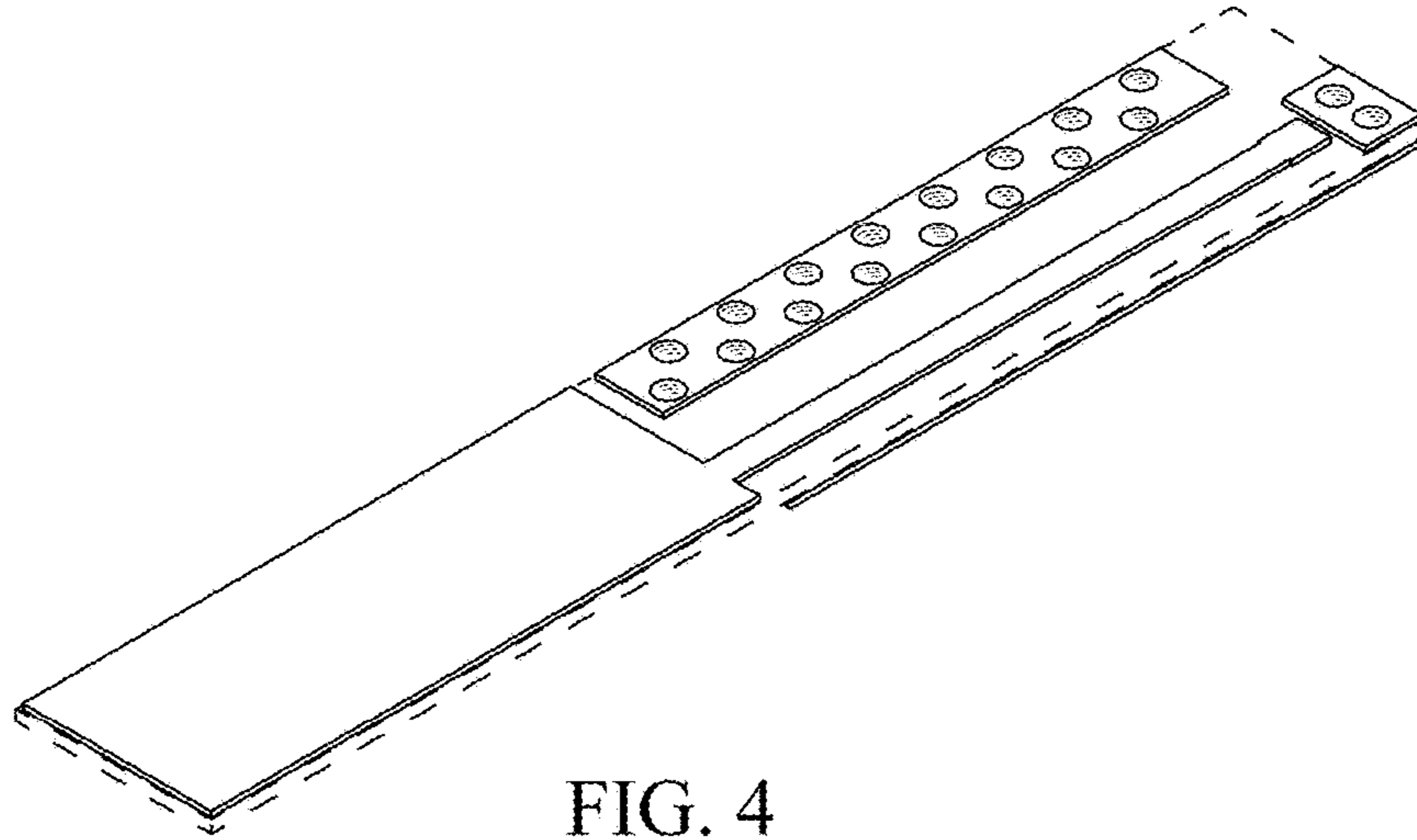

FIG. 4

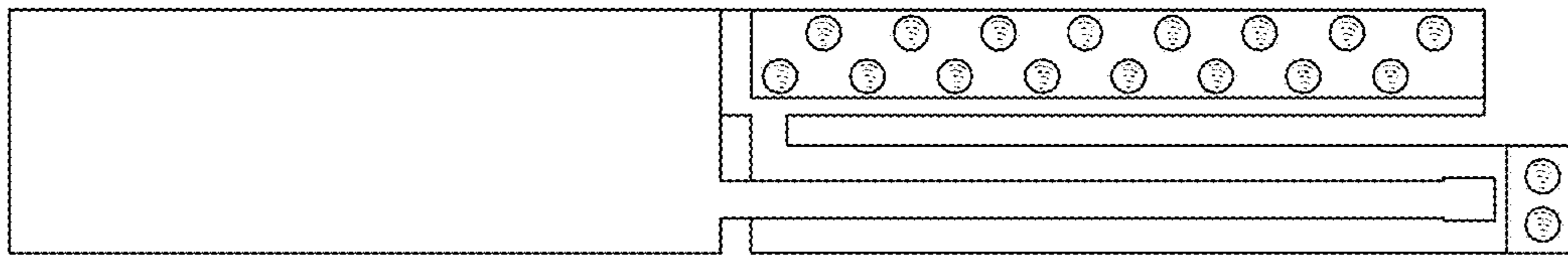

FIG. 5

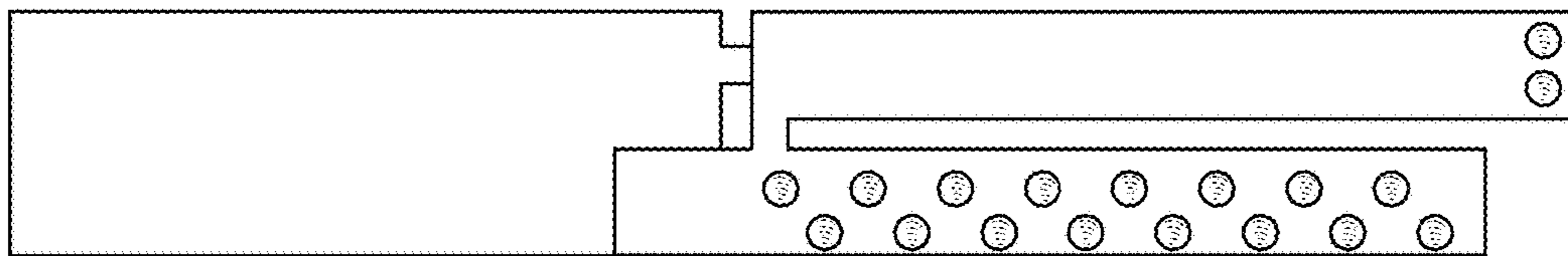

FIG. 6