



US00D809937S

(12) **United States Design Patent**  
**Nishi**

(10) **Patent No.:** **US D809,937 S**

(45) **Date of Patent:** **\*\* Feb. 13, 2018**

- (54) **CLOCK**
- (71) Applicant: **Rhythm Watch Co., Ltd.**, Saitama (JP)
- (72) Inventor: **Kiyokazu Nishi**, Saitama (JP)
- (73) Assignee: **Rhythm Watch Co., Ltd.**, Saitama (JP)
- (\*\*) Term: **15 Years**

5,926,443 A \* 7/1999 Kitaura ..... G04B 41/005  
368/165  
6,229,768 B1 \* 5/2001 Nakazawa ..... G04B 19/065  
368/223  
7,339,855 B2 \* 3/2008 Muraji ..... G04B 19/16  
368/223  
7,480,213 B2 \* 1/2009 Muraji ..... G04B 19/16  
368/223  
D706,141 S \* 6/2014 Kawase ..... D10/22  
(Continued)

(21) Appl. No.: **29/557,283**

(22) Filed: **Mar. 8, 2016**

(51) **LOC (11) Cl.** ..... **10-01**

(52) **U.S. Cl.**  
USPC ..... **D10/22; D10/124; D10/126**

(58) **Field of Classification Search**  
USPC ... D10/1, 6, 7, 9, 15, 16, 17, 18, 21, 24, 25,  
D10/27, 34, 39, 106.1, 123, 126, 128,  
D10/129, 124, 122, 22  
CPC ..... G04G 13/026; G04G 10/00; G04G 9/04;  
G04F 10/00; G04C 17/00; G04B 19/02  
See application file for complete search history.

(56) **References Cited**

**U.S. PATENT DOCUMENTS**

- D3,780 S \* 12/1869 Kroeber ..... D10/2
- D44,557 S \* 8/1913 Flauder ..... D10/11
- D44,607 S \* 9/1913 Flauder ..... D10/11
- D46,390 S \* 9/1914 Alexander ..... D10/126
- D78,043 S \* 3/1929 Streng ..... D10/1
- D131,206 S \* 1/1942 Hodge ..... D10/124
- D158,602 S \* 5/1950 Nelson ..... D10/29
- D204,776 S \* 5/1966 Appel ..... D10/11
- 3,531,635 A \* 9/1970 Hancock ..... F21S 10/002  
362/101
- D224,750 S \* 9/1972 Daher ..... D10/22
- D325,000 S \* 3/1992 Tanaka ..... D10/22
- D362,628 S \* 9/1995 Yamatani ..... D10/22
- D395,400 S \* 6/1998 Sharp ..... D10/29
- D403,595 S \* 1/1999 Liu ..... D10/28
- D407,023 S \* 3/1999 Kuo ..... D10/29

**OTHER PUBLICATIONS**

Gifts Online, Rhythm Clocks—Small World, no post date, [online], [site visited on Mar. 22, 2017]. Available from Internet, <URL: [http://www.giftsonline.net/catalog/Rhythm\\_Musical\\_Clocks.html](http://www.giftsonline.net/catalog/Rhythm_Musical_Clocks.html)>.\*

(Continued)

*Primary Examiner* — Sheryl Lane  
*Assistant Examiner* — Samantha N Wood  
(74) *Attorney, Agent, or Firm* — Kubotera & Associates, LLC

(57) **CLAIM**

The ornamental design for a clock, as shown and described.

**DESCRIPTION**

FIG. 1 is a front perspective view of a clock showing my new design;  
FIG. 2 is a front view thereof;  
FIG. 3 is a rear view thereof;  
FIG. 4 is a left side view thereof;  
FIG. 5 is a right side view thereof;  
FIG. 6 is a top plan view thereof;  
FIG. 7 is a bottom view thereof; and,  
FIG. 8 is a front perspective view thereof with a transparent front plate.  
Please note that the portions of the article shown in broken lines form no part of the claimed design.

**1 Claim, 8 Drawing Sheets**

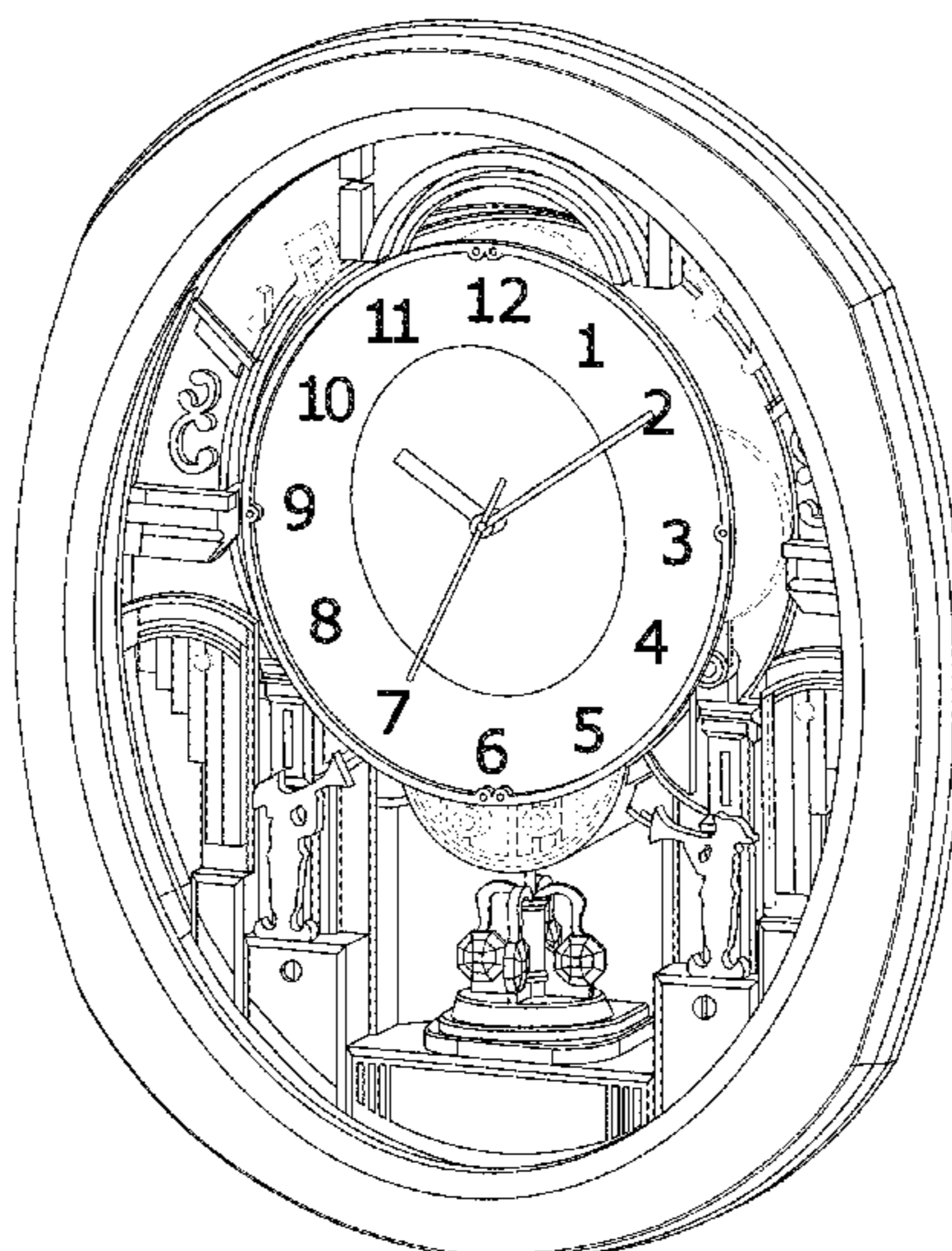

(56)

**References Cited**

U.S. PATENT DOCUMENTS

D706,646 S \* 6/2014 Nishi ..... D10/1  
D707,136 S \* 6/2014 Nishi ..... D10/1  
D724,957 S \* 3/2015 Horiba ..... D10/22  
D734,172 S \* 7/2015 Nishi ..... D10/124  
9,244,435 B2 \* 1/2016 Tako ..... G04B 45/0038  
2011/0019507 A1 \* 1/2011 Muraji ..... G04B 19/065  
368/220

OTHER PUBLICATIONS

Amazon, Enchanting Rhythm Musical Motion Clock, first available on Apr. 4, 2017, [online], [site visited on Mar. 22, 2017]. Available from Internet, <URL: [https://www.amazon.co.uk/Enchanting-Rhythm-Musical-Swarovski-Elements/dp/B007RCFWXE/ref=sr\\_1\\_47?ie=UTF8&qid=1490197304&sr=8-47&keywords=rhythm+clock](https://www.amazon.co.uk/Enchanting-Rhythm-Musical-Swarovski-Elements/dp/B007RCFWXE/ref=sr_1_47?ie=UTF8&qid=1490197304&sr=8-47&keywords=rhythm+clock)>.\*

\* cited by examiner

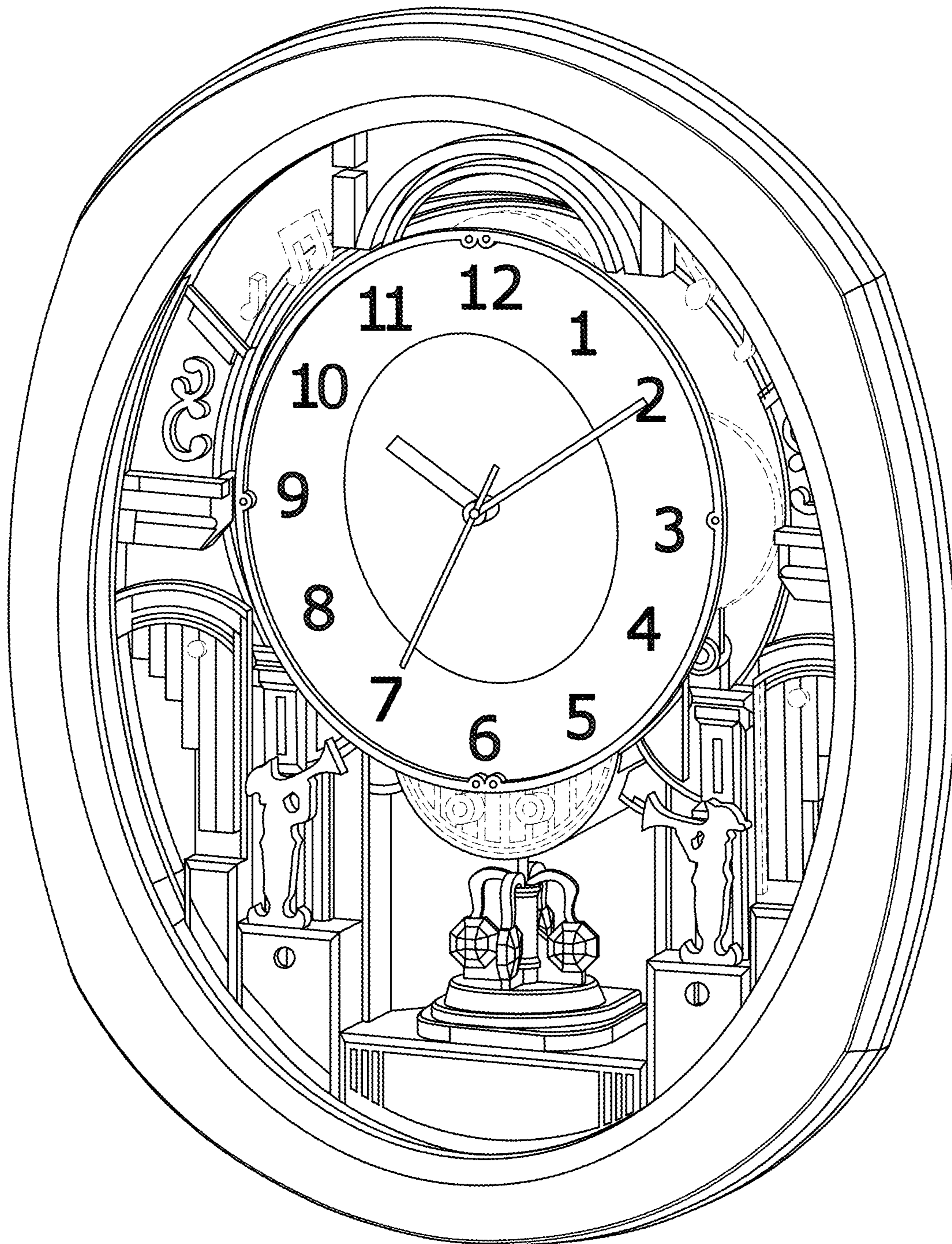

FIG. 1

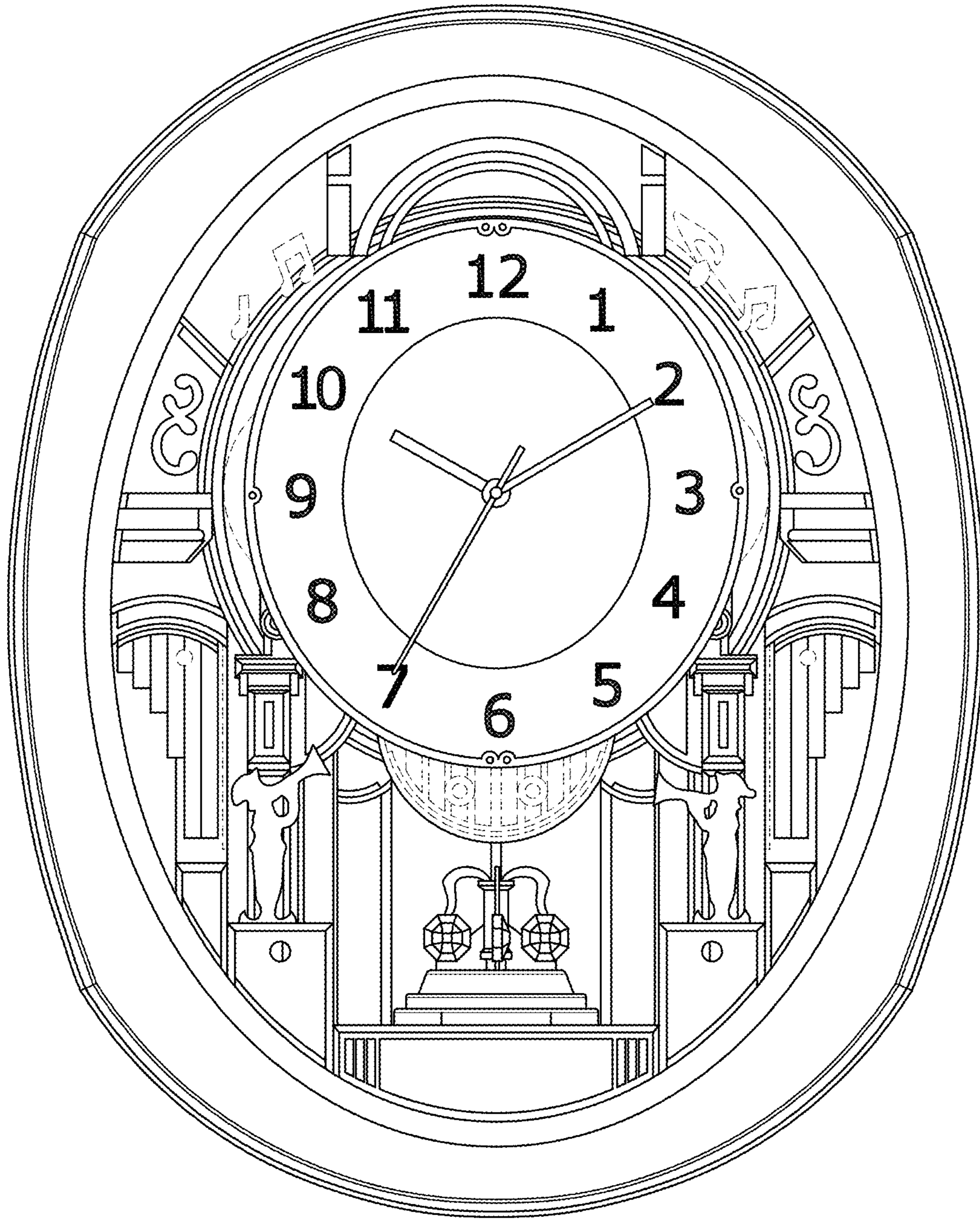

FIG. 2

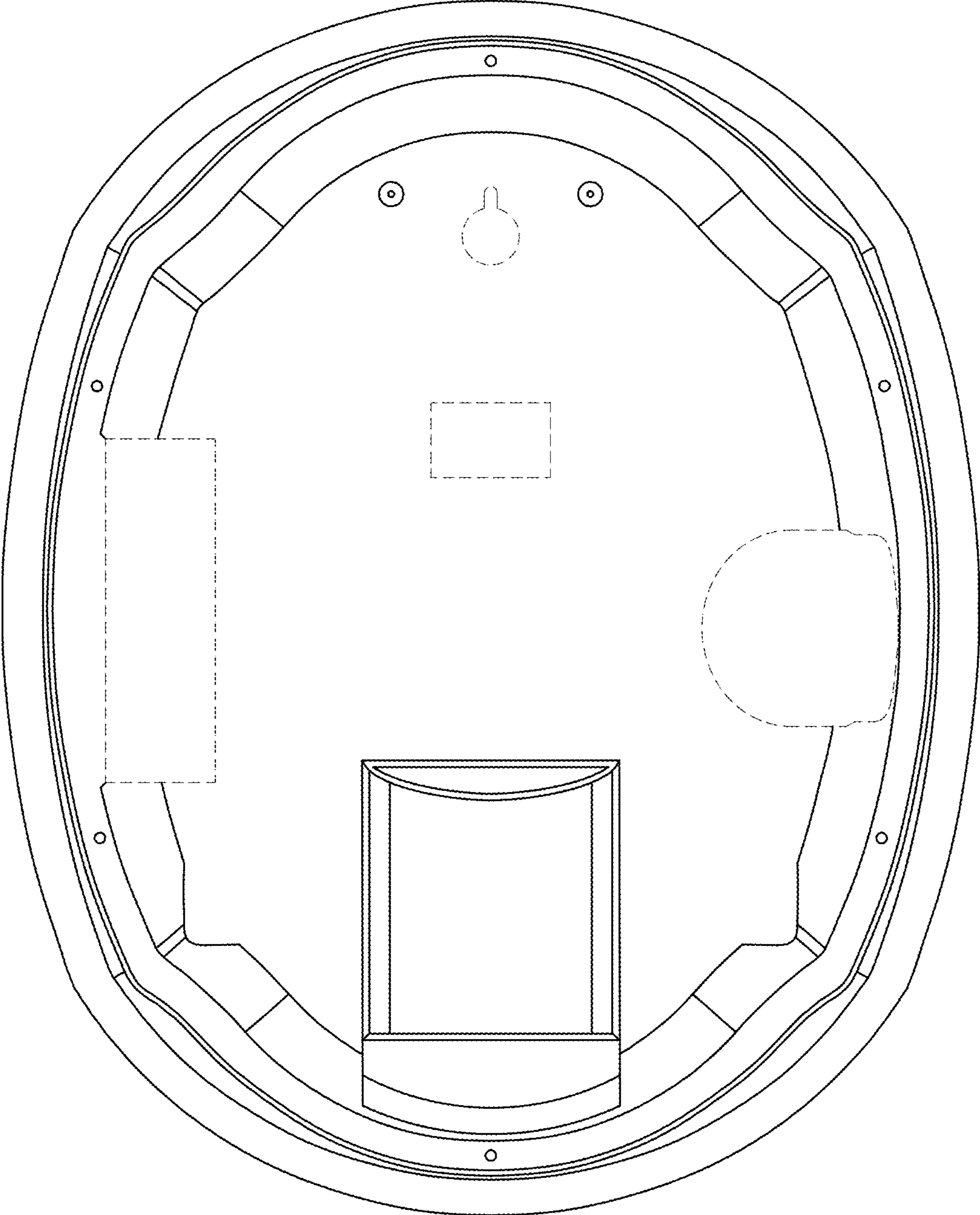

FIG.3

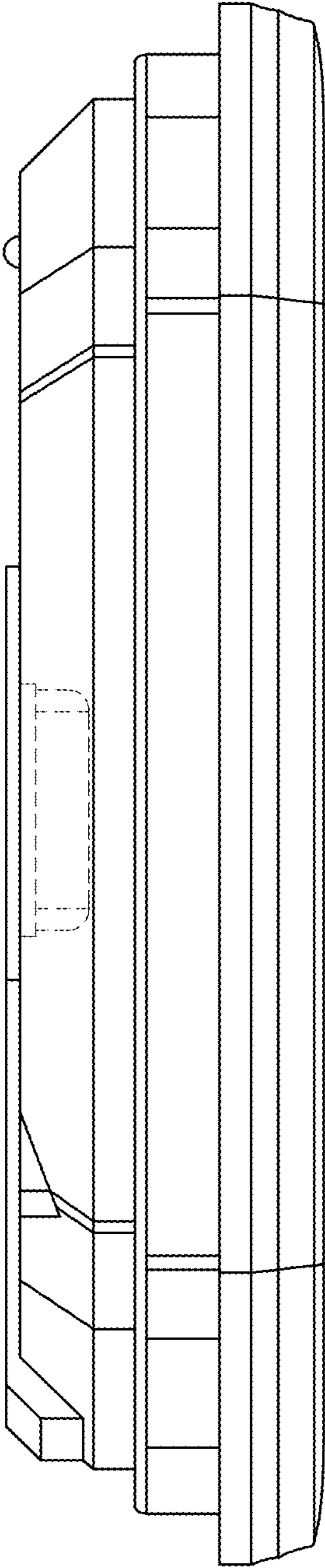

FIG.4

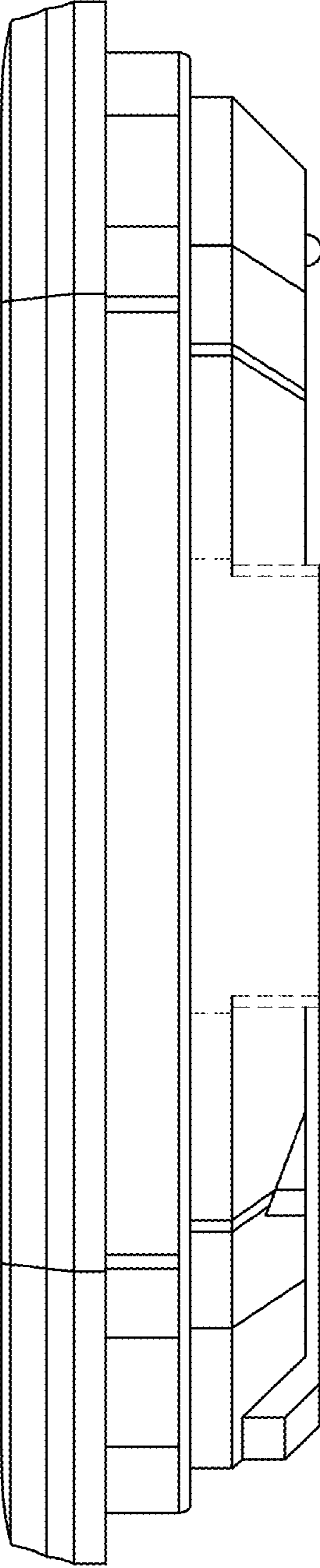

FIG. 5

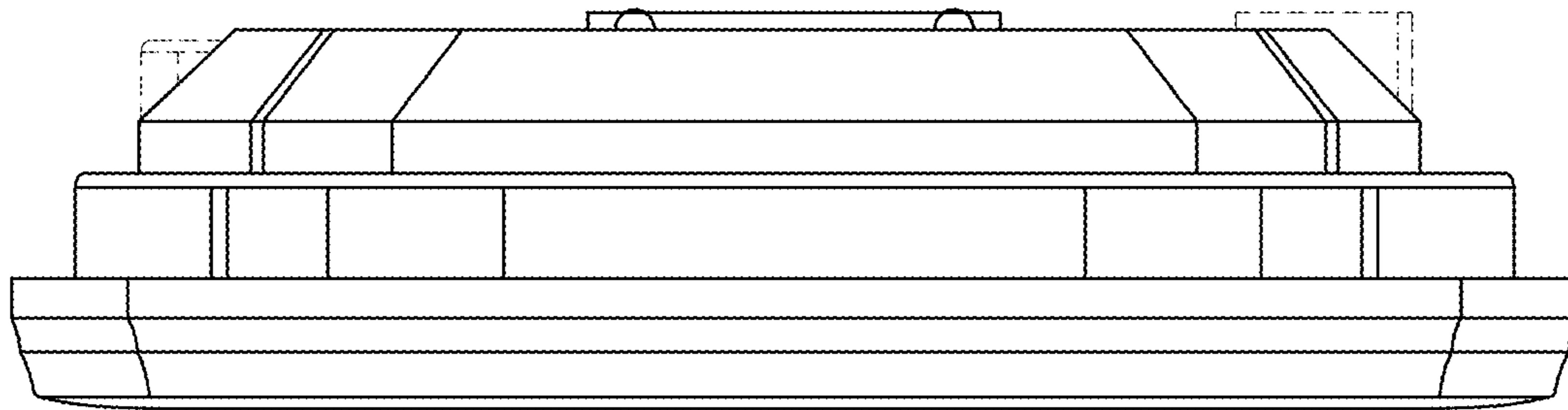

FIG. 6



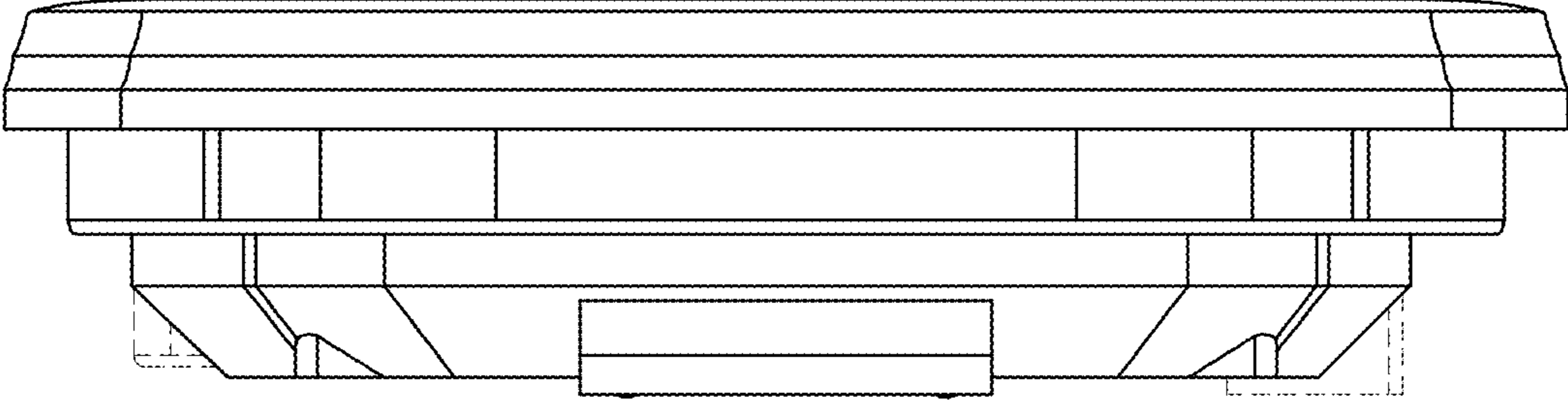

FIG. 7

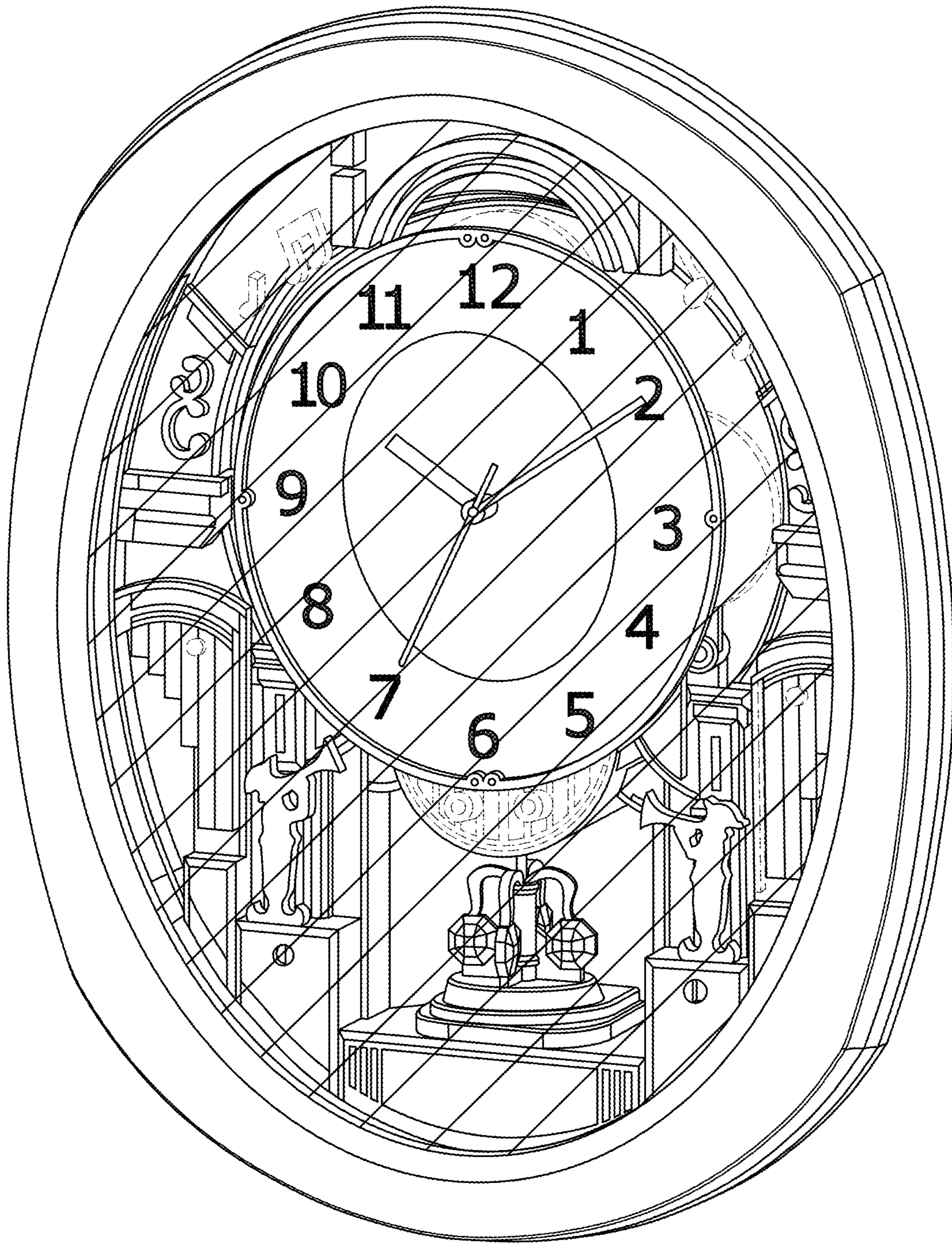

FIG. 8