



US00D809929S

(12) **United States Design Patent**
Kagawa

(10) **Patent No.:** **US D809,929 S**

(45) **Date of Patent:** **** Feb. 13, 2018**

(54) **PACKAGING FILM**

(71) Applicant: **FUJIFILM CORPORATION**,
Minato-ku, Tokyo (JP)

(72) Inventor: **Yusuke Kagawa**, Kanagawa (JP)

(73) Assignee: **FUJIFILM CORPORATION**, Tokyo
(JP)

(**) Term: **15 Years**

(21) Appl. No.: **29/576,733**

(22) Filed: **Sep. 7, 2016**

(30) **Foreign Application Priority Data**

Mar. 11, 2016 (JP) 2016-005416

(51) **LOC (11) Cl.** **09-05**

(52) **U.S. Cl.**
USPC **D9/711**

(58) **Field of Classification Search**

USPC D9/702-714, 719, 738-740, 517-518,
D9/522, 416, 435, 444, 460, 455, 414,
D9/499, 431-432; D7/560-562;
206/434, 426-427, 429-430, 485, 485.1,
206/499, 508, 431, 418-422, 588-594;
229/117.3, 185, 121, 122, 200, 207, 236,
229/87.01; 220/23.83; 150/100-118;
294/137, 152; 383/6, 10, 14, 20, 40, 33,
383/104-105, 117, 108, 120, 93, 121.1,
383/127; 428/34.3

CPC B65D 5/0254; B65D 5/02; B65D 5/54;
B65D 5/18; B65D 5/0045; B65D 5/0015;
B65D 5/2033; B65D 5/42; B65D 85/00;
B65D 85/38; B65D 77/00; B65D 77/02

See application file for complete search history.

(56) **References Cited**

U.S. PATENT DOCUMENTS

D513,177 S	*	12/2005	Tachikawa	D9/432
D552,470 S	*	10/2007	Kawaguchi	D9/432
D600,944 S	*	9/2009	McConnell	D6/675
D622,959 S	*	9/2010	Zalewski	D3/273
D729,059 S	*	5/2015	Taylor	D9/432
D741,165 S	*	10/2015	Yassin	D9/414
D773,558 S	*	12/2016	Melnick	D19/90

* cited by examiner

Primary Examiner — Abraham Bahta

(74) *Attorney, Agent, or Firm* — SOLARIS Intellectual
Property Group, PLLC

(57) **CLAIM**

The ornamental design for a packaging film, as shown and
described.

DESCRIPTION

FIG. 1 is a perspective view of a packaging film, showing
our new design;

FIG. 2 is a front view thereof;

FIG. 3 is a rear view thereof;

FIG. 4 is a top view thereof;

FIG. 5 is a bottom view thereof;

FIG. 6 is a left side view thereof;

FIG. 7 is a right side view thereof; and,

FIG. 8 is a reference perspective view showing a usage state
thereof, shown for clarity of disclosure.

The packaging film according to the present design appli-
cation is fully transparent and is able to surround plural
magnetic tape cartridges as one package with a rear label
side being exposed. The broken lines represent environment
and form no part of the claimed design.

1 Claim, 8 Drawing Sheets

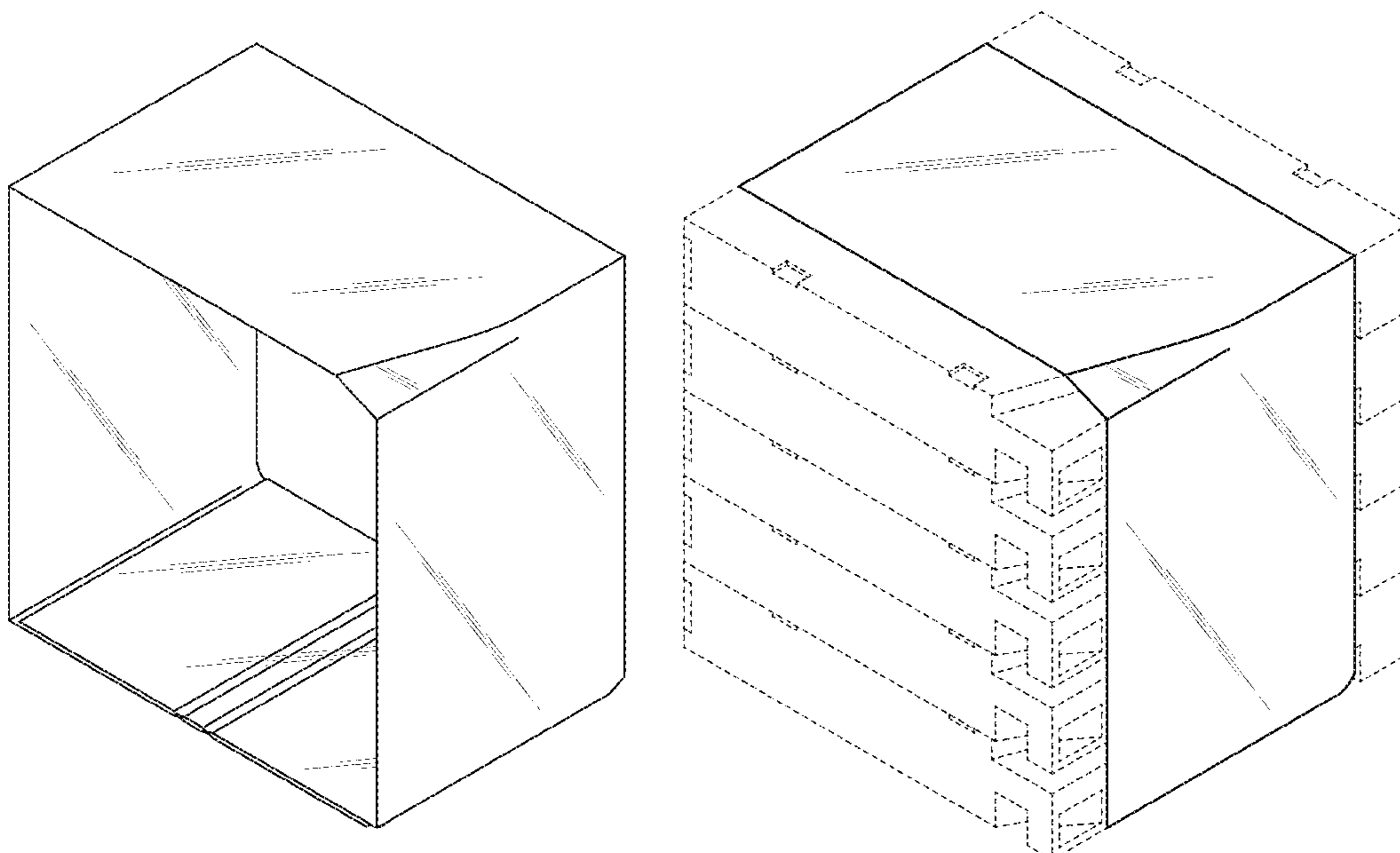

FIG. 1

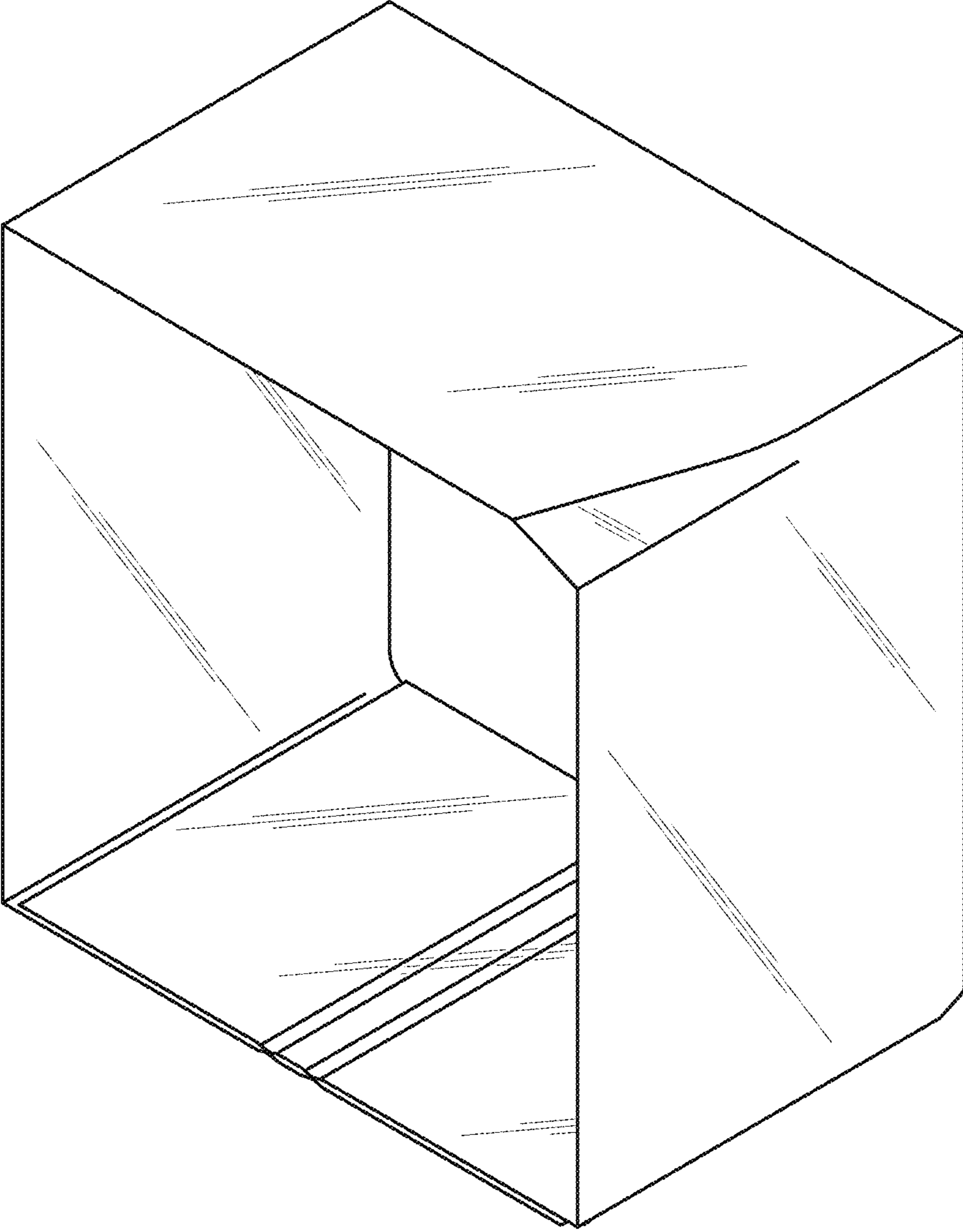

FIG. 2

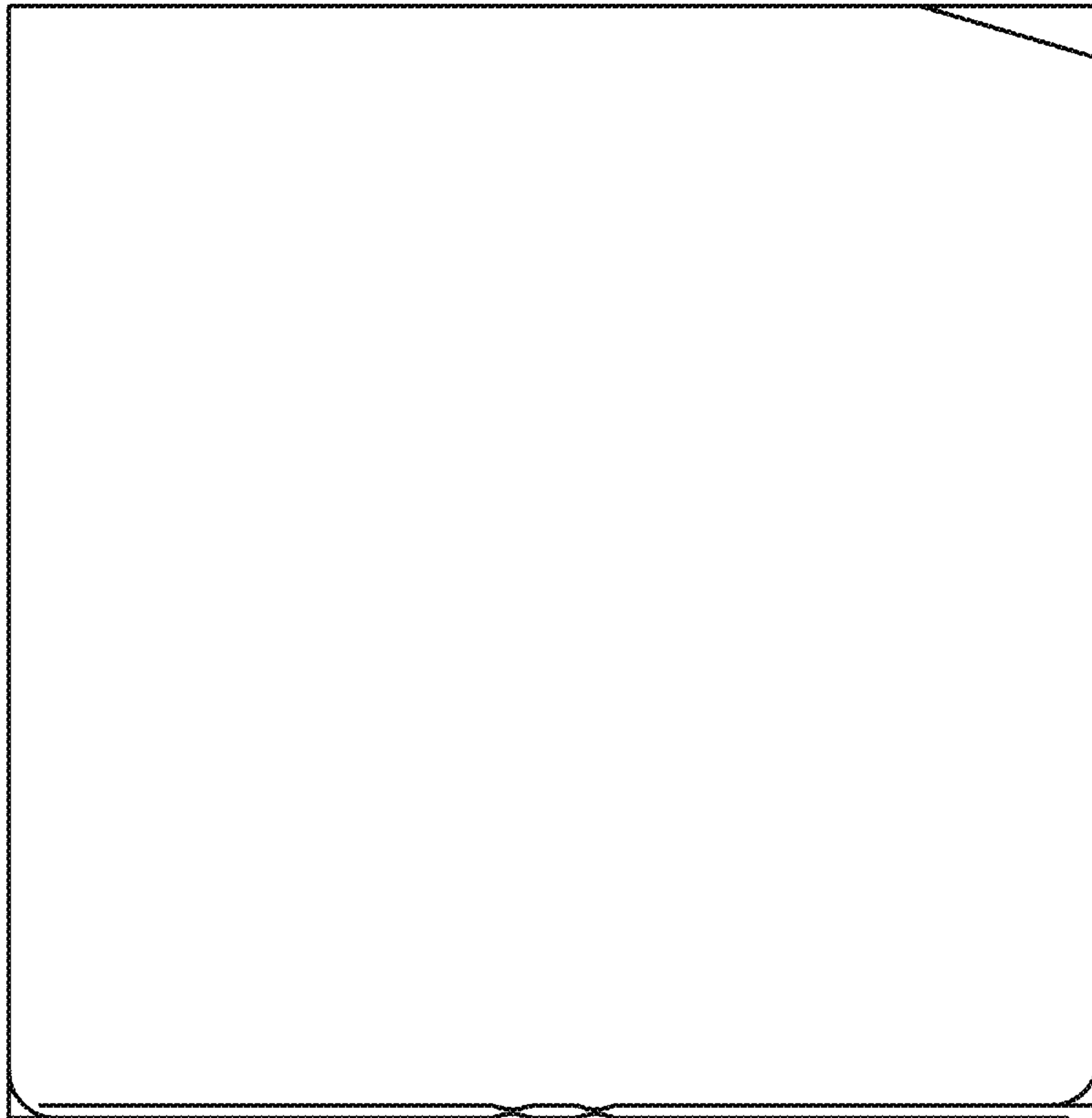

FIG. 3

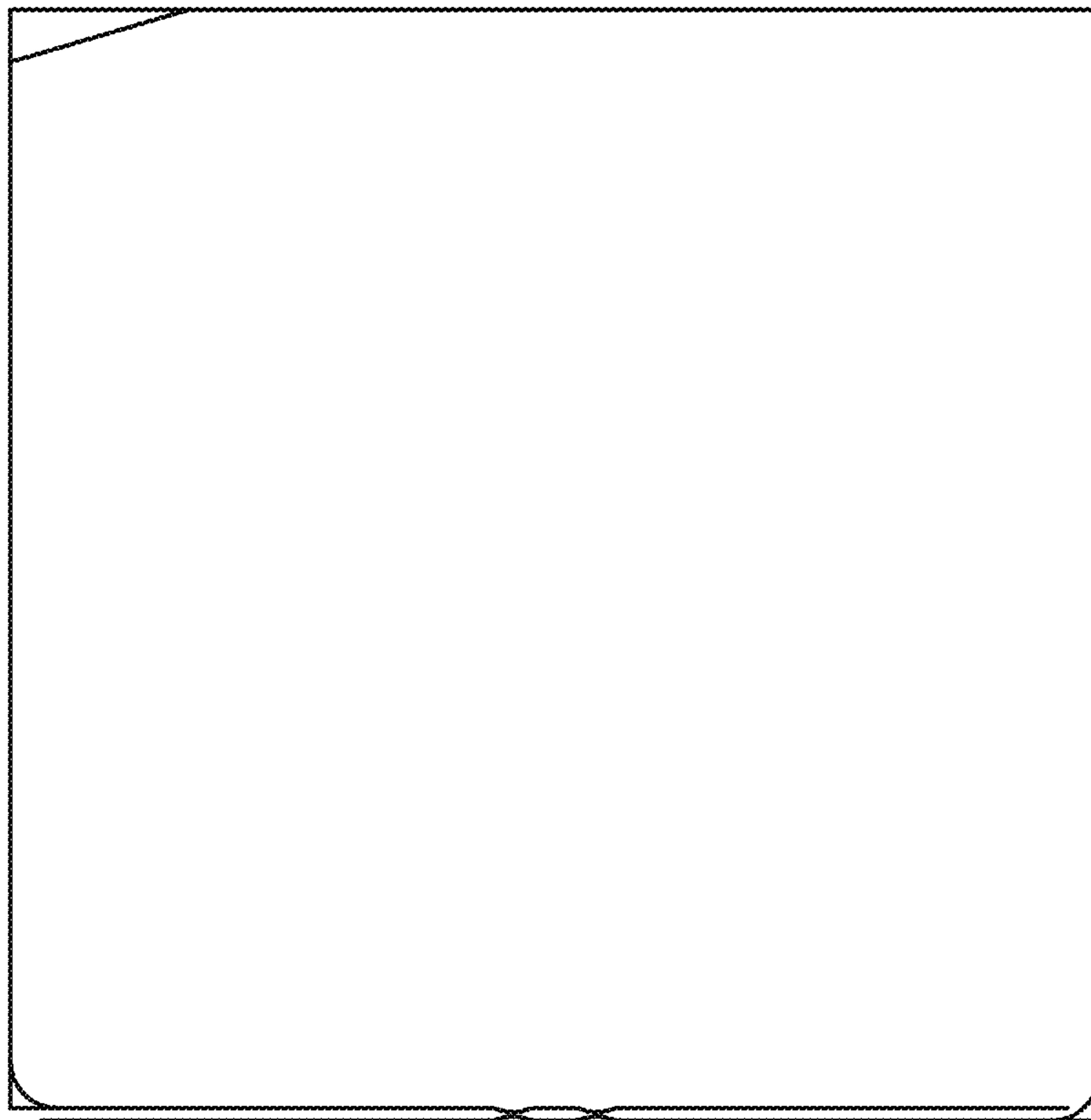

FIG. 4

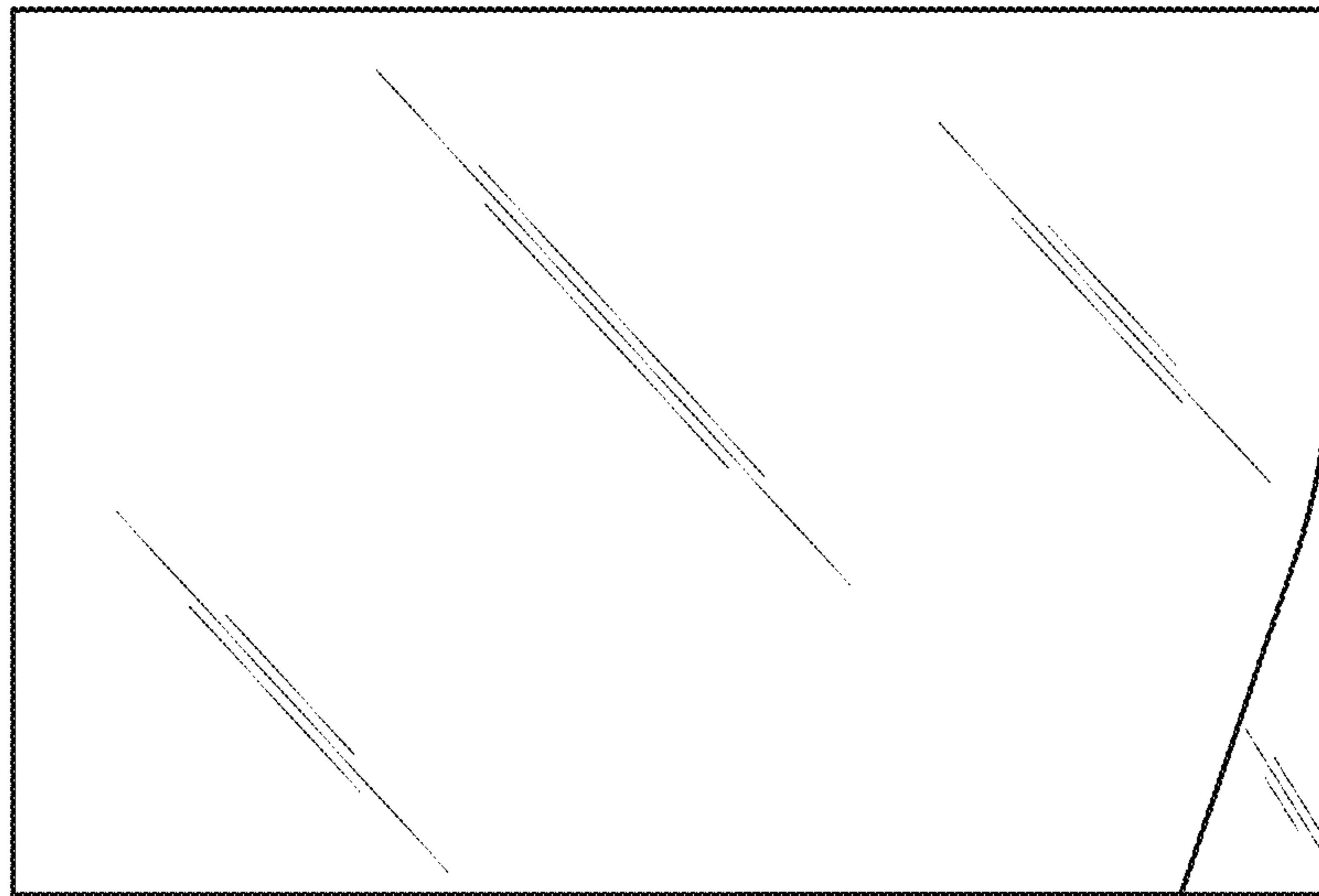

FIG. 5

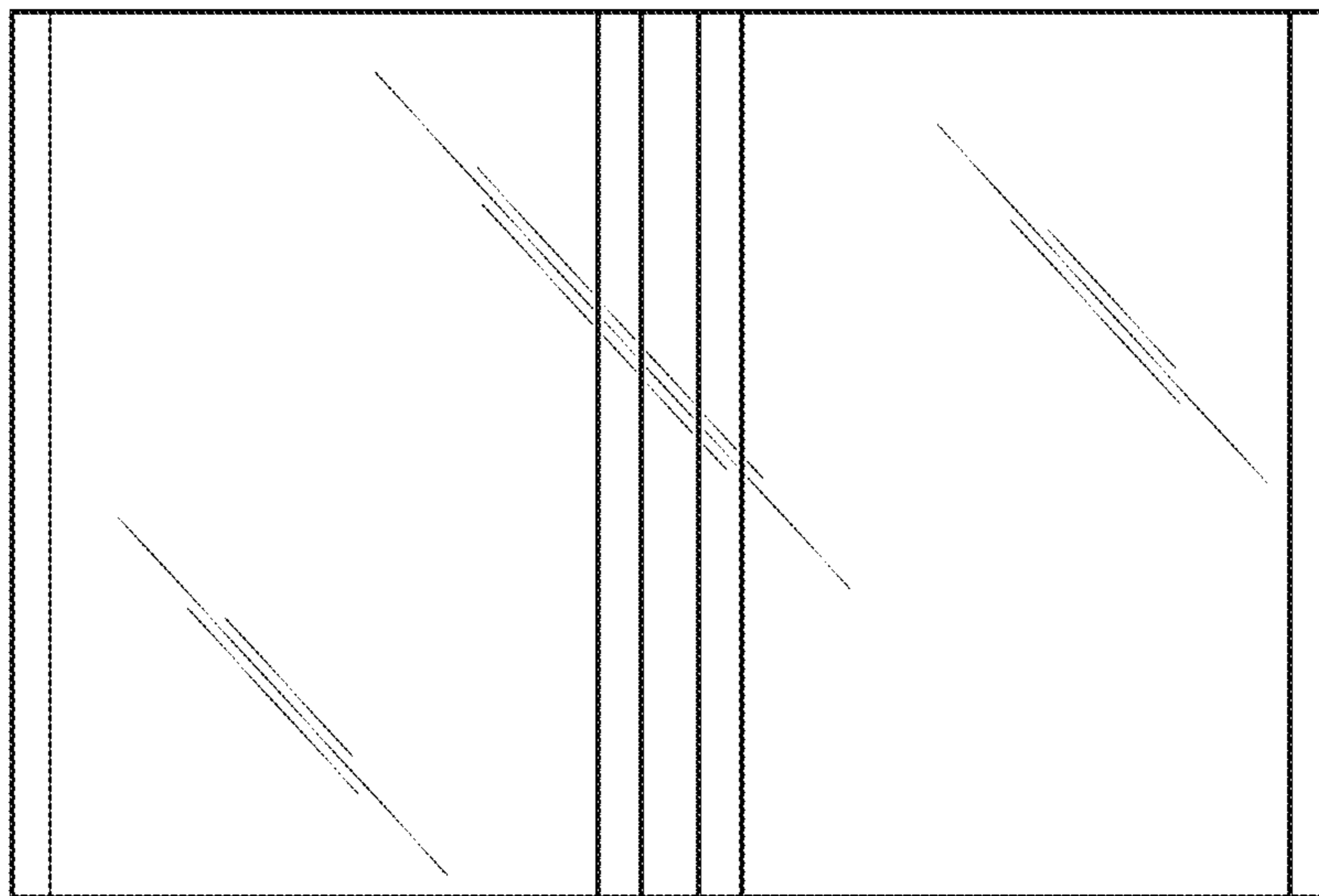

FIG. 6

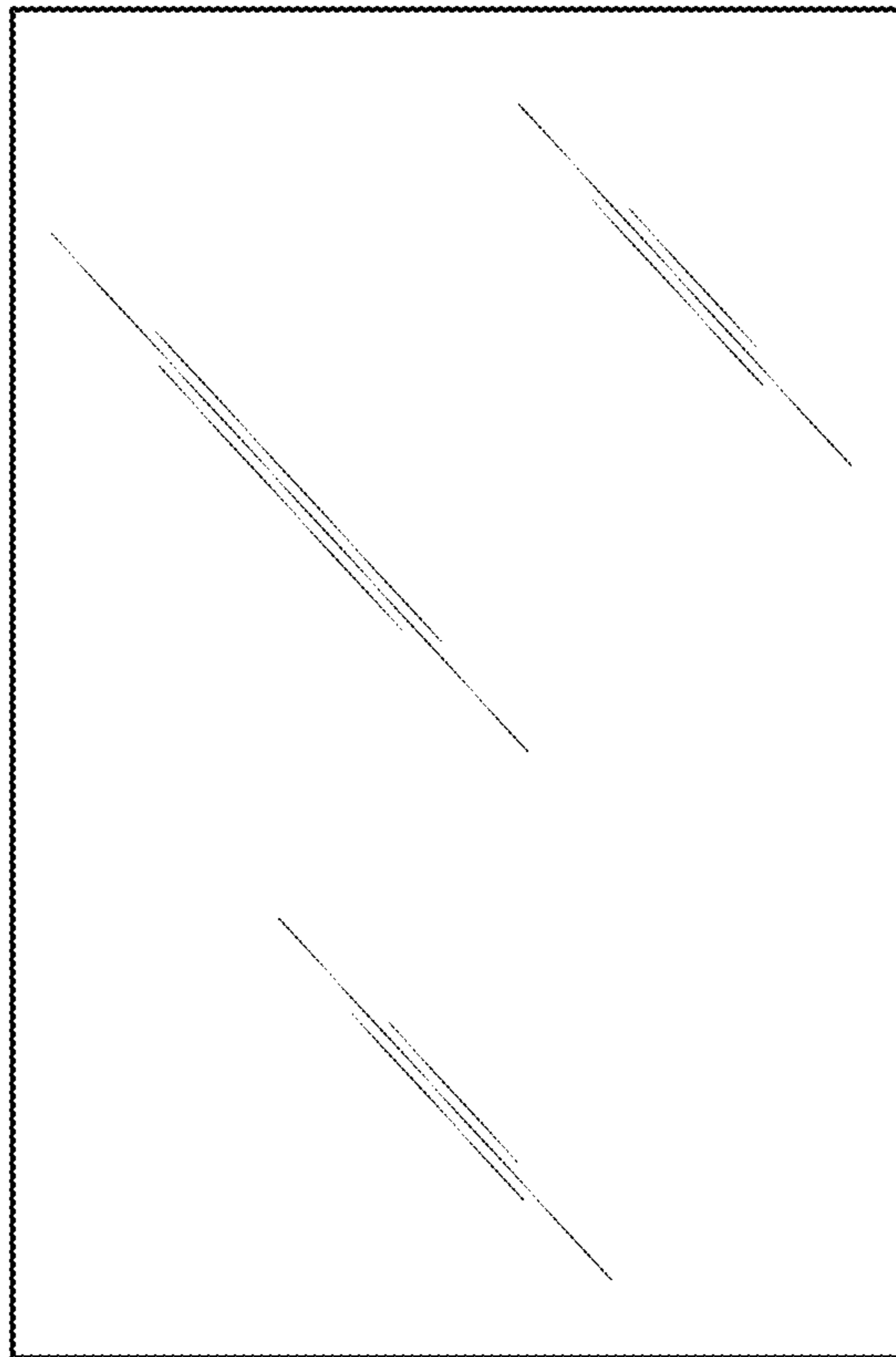

FIG. 7

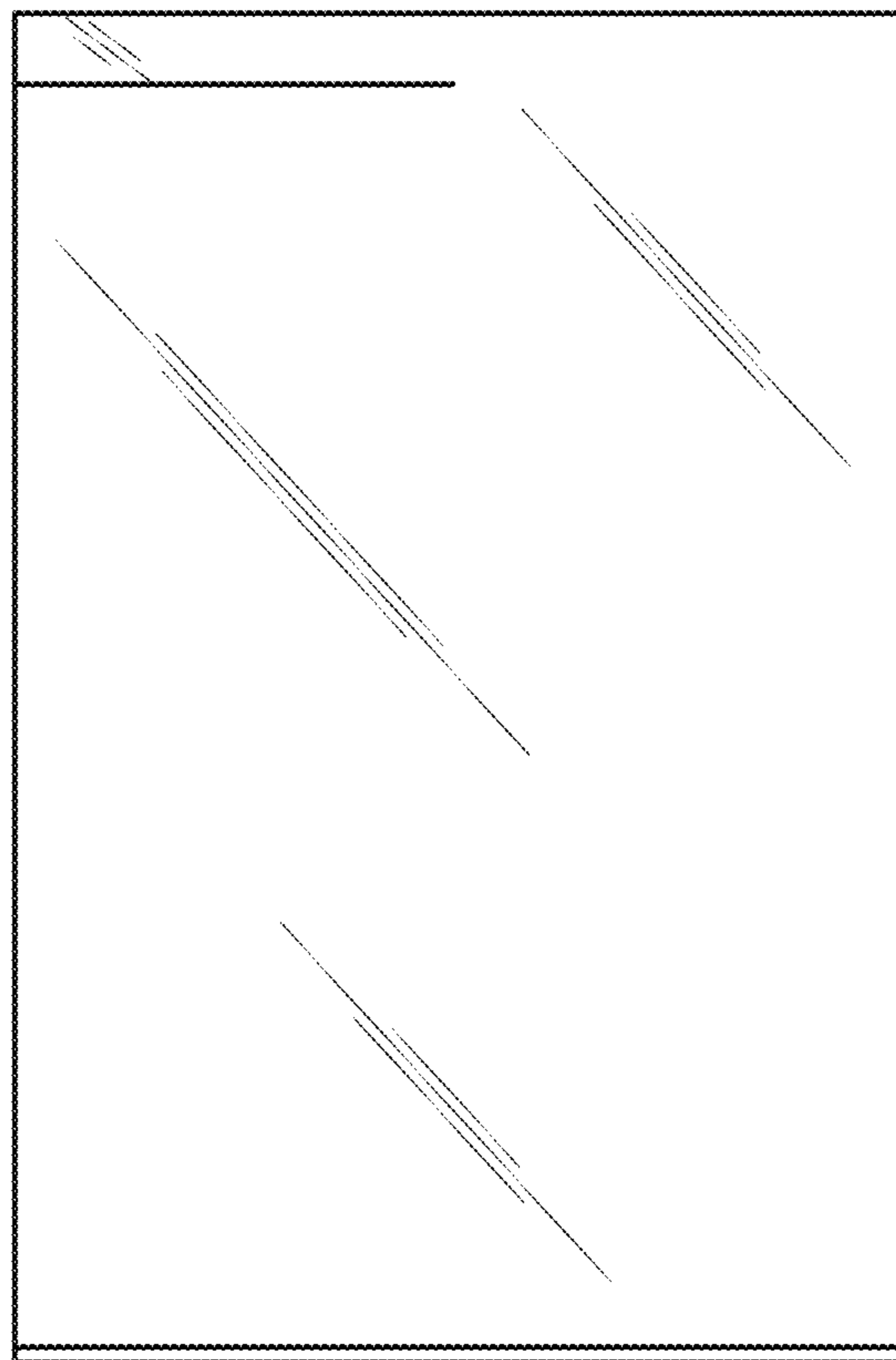

FIG. 8

