



US00D809898S

(12) **United States Design Patent**  
**Lindeman et al.**

(10) **Patent No.:** **US D809,898 S**  
(45) **Date of Patent:** **\*\* Feb. 13, 2018**

(54) **MOUNTING BRACKET FOR HEAT SINK MODULE**

(71) Applicant: **EBULLIENT, LLC**, Madison, WI (US)

(72) Inventors: **Brett A. Lindeman**, Madison, WI (US);  
**Robert A. Buchanan**, Madison, WI (US)

(73) Assignee: **EBULLIENT, INC.**, Madison, WI (US)

(\*\*) Term: **15 Years**

(21) Appl. No.: **29/529,999**

(22) Filed: **Jun. 11, 2015**

(51) **LOC (11) Cl.** ..... **08-08**

(52) **U.S. Cl.**  
USPC ..... **D8/349**

(58) **Field of Classification Search**  
USPC ..... D8/349, 354, 363, 355, 364, 366, 371,  
D8/373, 380, 381; D14/451, 452;  
248/222.11, 274.1, 278.1, 284.1, 220.22,  
248/221.11, 221.12, 222.13, 222.41,  
248/223.31, 223.41, 224.51, 224.61,  
248/224.8, 225.11, 316.2, 407, 346.03,  
248/346.04, 346.06, 177.1, 178.1, 187.1;  
224/547, 548, 554, 567, 571  
CPC ..... B60R 2011/0059; B60R 2011/0061; B60R  
2011/0073; B60R 2011/0078; B60R  
2011/0084; F16M 11/041; F16M 13/02;  
F16M 2200/02; B60P 7/0807; B60P  
7/0815; F16B 2/14; A61B 90/50  
See application file for complete search history.

(56) **References Cited**

**U.S. PATENT DOCUMENTS**

D288,280 S \* 2/1987 Schnable ..... 74/606 R  
D428,799 S \* 8/2000 Stearns ..... D8/354

D534,905 S \* 1/2007 Sergi ..... D14/238  
D535,985 S \* 1/2007 Sergi ..... D14/238  
D649,863 S \* 12/2011 Meyer ..... D8/354  
D657,231 S \* 4/2012 Springer ..... D14/239  
D699,270 S \* 2/2014 Beidler ..... D15/28  
D755,683 S \* 5/2016 Goodlow ..... D12/114

\* cited by examiner

*Primary Examiner* — Mark Goodwin

(74) *Attorney, Agent, or Firm* — Nicholas J. Boyarski

(57) **CLAIM**

The ornamental design for a mounting bracket for a heat sink module, as shown and described.

**DESCRIPTION**

FIG. 1 is top perspective view of a mounting bracket for a heat sink module;  
FIG. 2 is a bottom perspective view of the mounting bracket of FIG. 1;  
FIG. 3 is a top view of the mounting bracket of FIG. 1;  
FIG. 4 is a bottom view of the mounting bracket of FIG. 1;  
FIG. 5 is a front view of the mounting bracket of FIG. 1;  
FIG. 6 is a rear view of the mounting bracket of FIG. 1;  
FIG. 7 is a left side view of the mounting bracket of FIG. 1;  
FIG. 8 is a right side view of the mounting bracket of FIG. 1;  
FIG. 9 is a top perspective view of the mounting bracket of FIG. 1; and,  
FIG. 10 is a top view of the mounting bracket of FIG. 1.  
The broken lines shown in the figures are for illustrative purposes only and form no part of the claimed design.

**1 Claim, 5 Drawing Sheets**

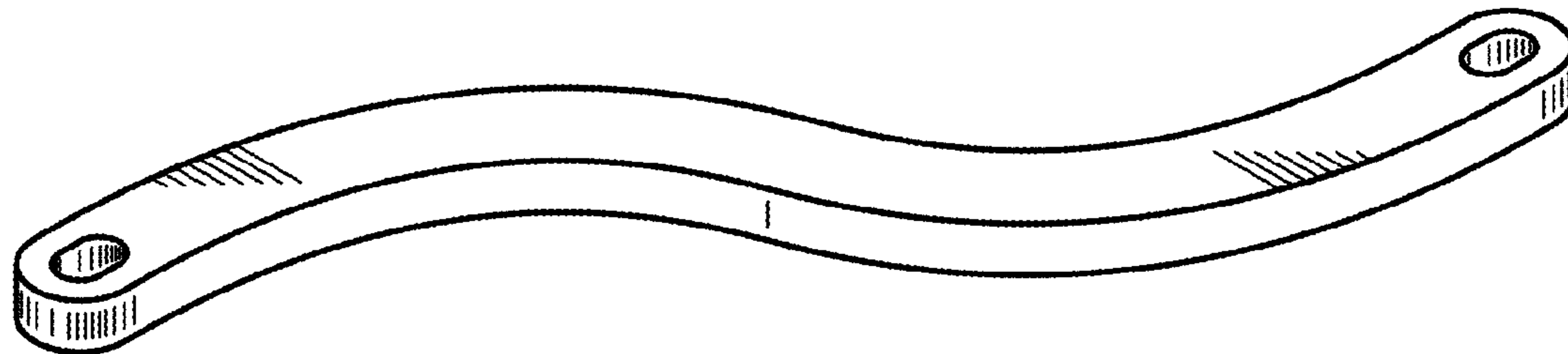

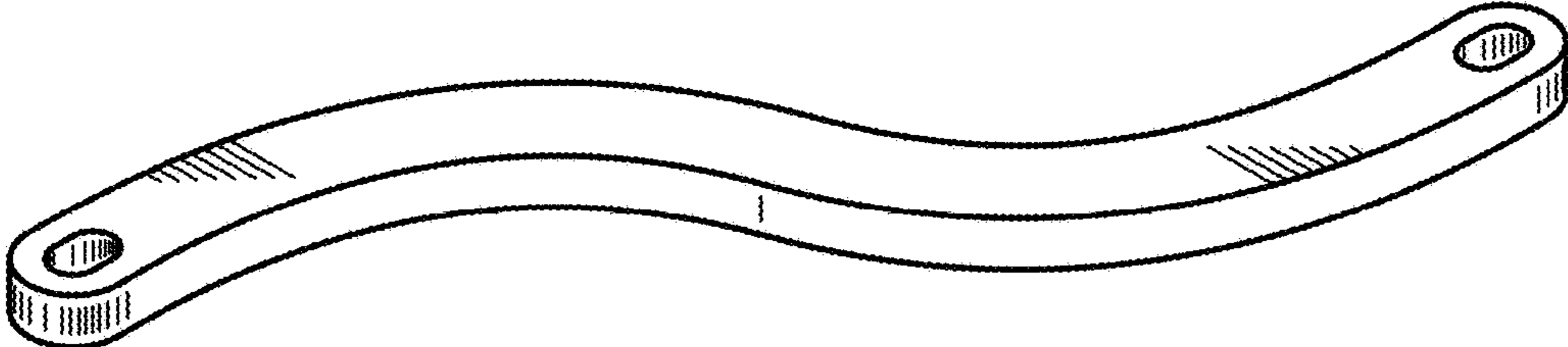

FIG. 1

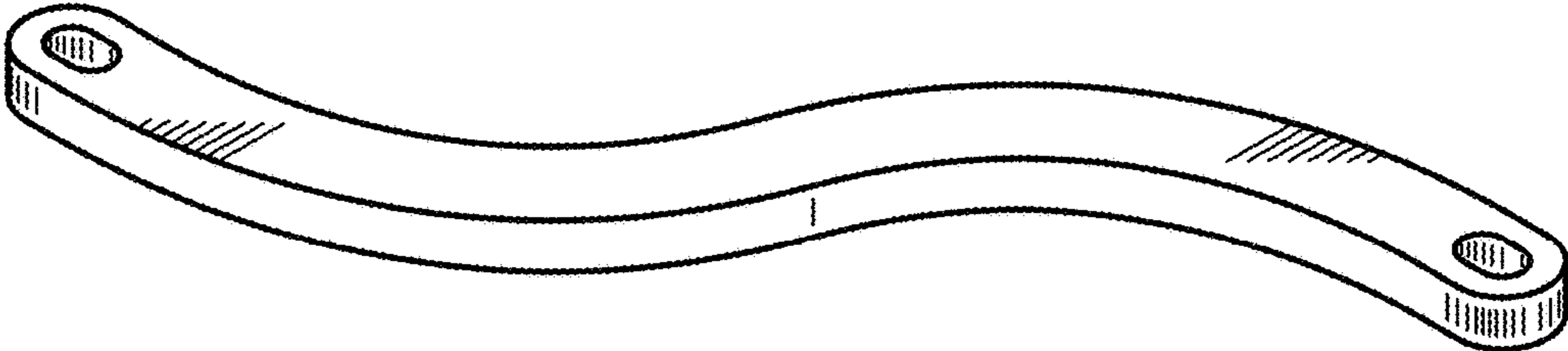

FIG. 2

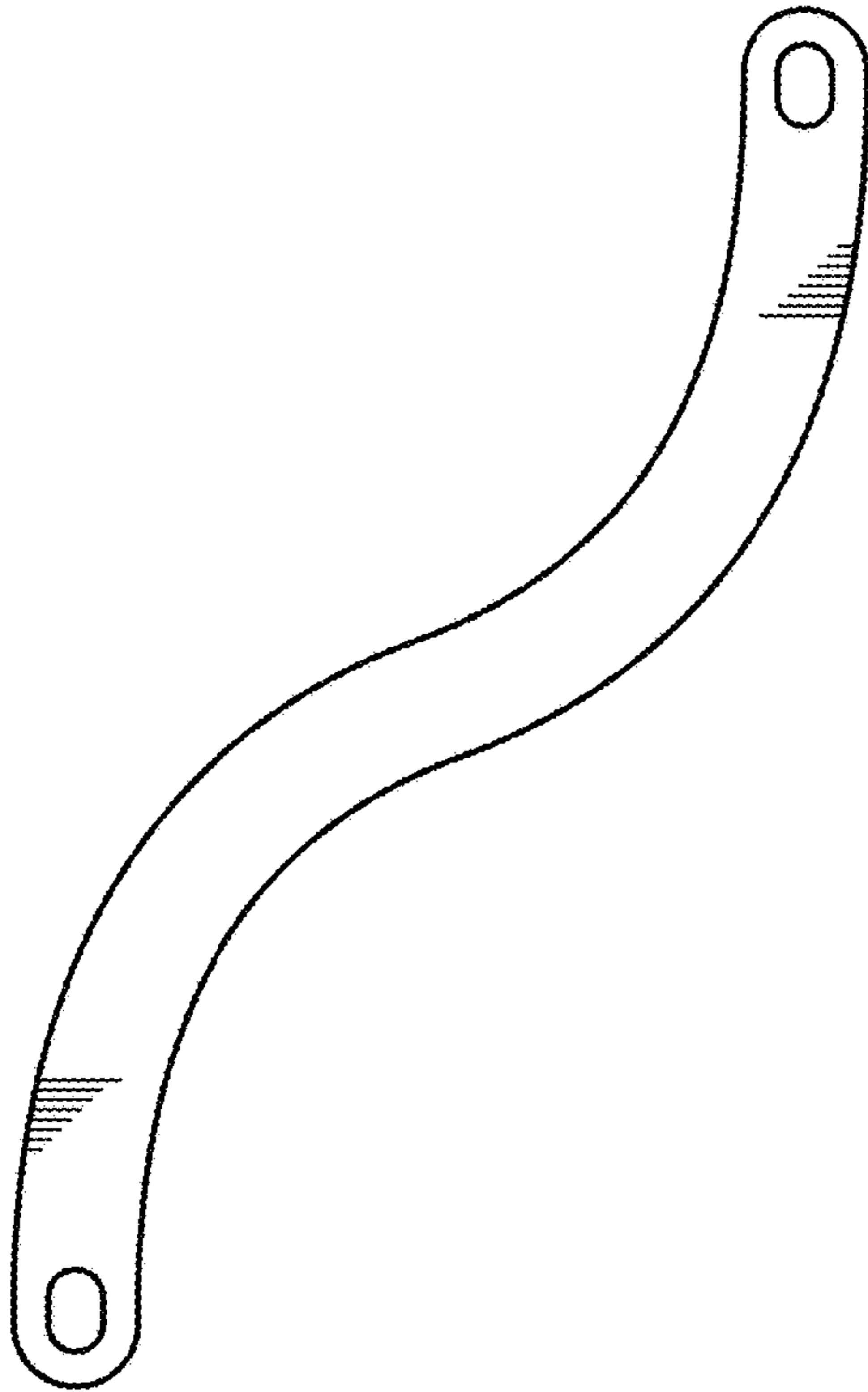

FIG. 3

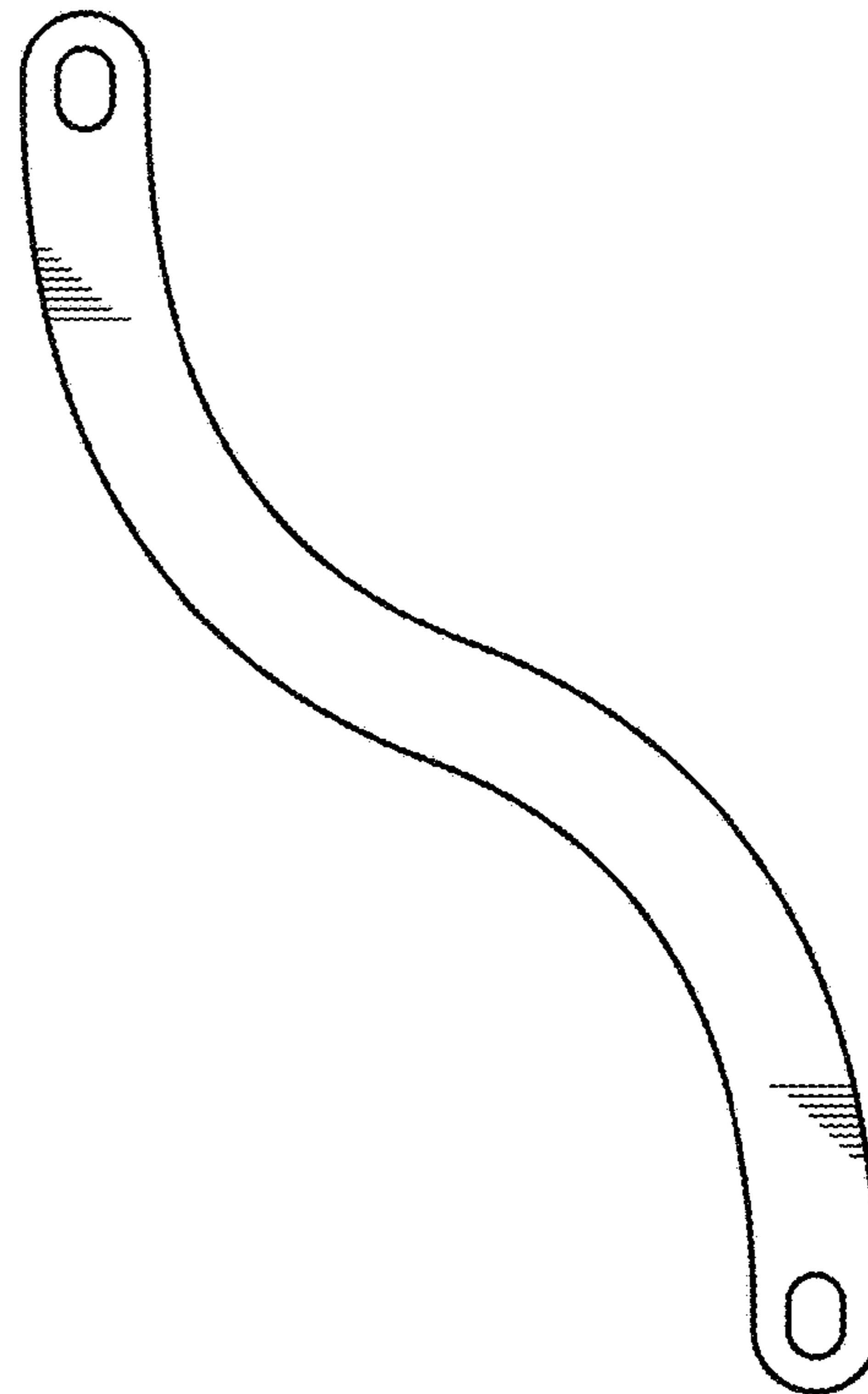

FIG. 4



FIG. 5



FIG. 6



FIG. 7



FIG. 8

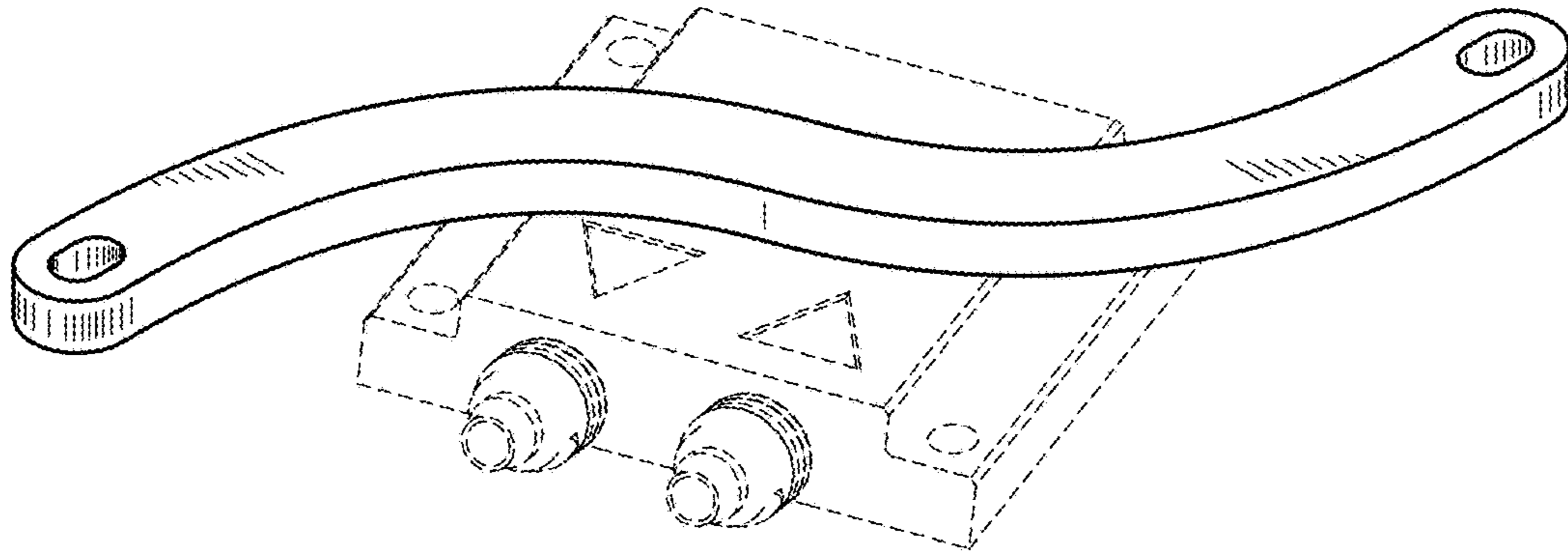

FIG. 9

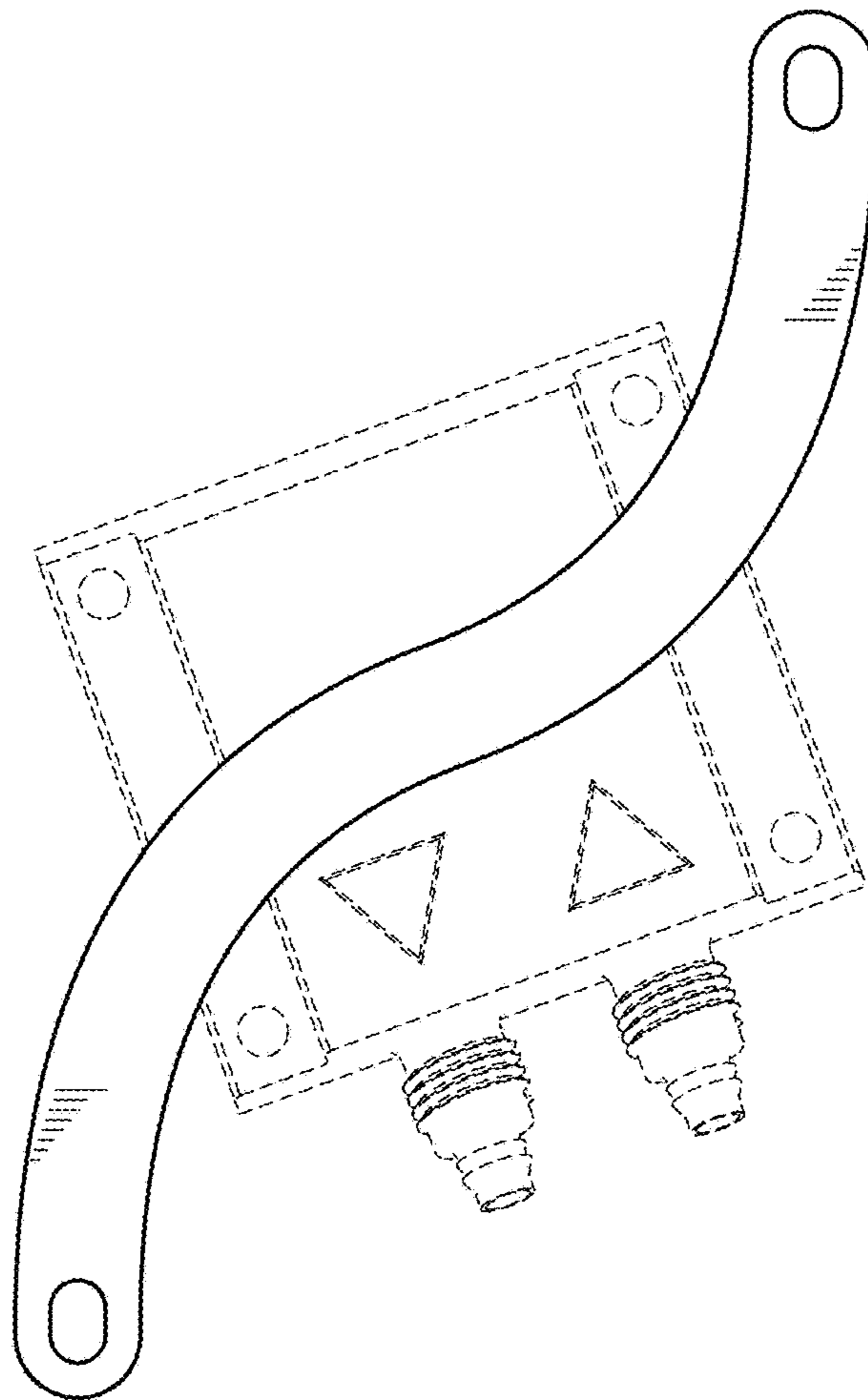

FIG. 10