



US00D809496S

(12) **United States Design Patent** (10) **Patent No.:** **US D809,496 S**
Kim (45) **Date of Patent:** **** Feb. 6, 2018**

(54) **CASE FOR ELECTRONIC DEVICE**

- (71) Applicant: **Dae-Young Kim**, Seoul (KR)
- (72) Inventor: **Dae-Young Kim**, Seoul (KR)
- (73) Assignee: **SPIGEN KOREA CO., LTD.**,
Geumcheon-Gu, Seoul (KR)

(**) Term: **15 Years**

(21) Appl. No.: **29/539,320**

(22) Filed: **Sep. 13, 2015**

(51) **LOC (11) Cl.** **14-03**

(52) **U.S. Cl.**
USPC **D14/250**

(58) **Field of Classification Search**
USPC D14/250–253, 440, 203.3–203.7, 217,
D14/496, 248, 238.1, 240, 447, 230, 247,
D14/341, 345, 346, 439; D3/201, 218,
D3/269, 301, 273, 303; D13/103,
D13/107–108; 220/4.02; 248/309.1;
361/679.56; 379/426, 433.11, 455;
455/575.1, 575.8; 190/100; 206/305,
206/320

CPC . A45C 2011/002; A45C 11/00; A45C 13/002;
A45C 2011/003; H04M 1/0283; H04M
1/0202; H04M 1/185; H04B 1/3888

See application file for complete search history.

(56) **References Cited**

U.S. PATENT DOCUMENTS

- D589,953 S * 4/2009 Turner D14/248
- D663,724 S * 7/2012 Lee D14/248
- D684,554 S * 6/2013 Park D14/138 G
- D686,586 S * 7/2013 Cho D14/138 G
- D716,785 S * 11/2014 White D14/250
- D720,735 S * 1/2015 Turocy D14/250
- D723,018 S * 2/2015 White D14/250
- D747,707 S 1/2016 Roberts et al.
- D747,708 S 1/2016 Roberts et al.

(Continued)

OTHER PUBLICATIONS

RecomHub, “Most Popular iPhone 6 or iPhone 6 Plus Case: Apple Leather Case”, <http://recomhub.com/blog/most-popular-iphone-6-or-iphone-6-plus-case-apple-leather-case/> (date retrieval from <https://web.archive.org/>); first available online Oct. 17, 2014 (retrieved Jun. 10, 2017).*

(Continued)

Primary Examiner — Sandra Snapp

Assistant Examiner — Holly E Thurman

(74) *Attorney, Agent, or Firm* — Lucem, PC; Heedong Chae

(57) **CLAIM**

The ornamental design for a case for electronic device, as shown and described.

DESCRIPTION

FIG. 1 is a front perspective view of a case, comprised of a transparent cover and three flexible inserts, for an electronic device showing my new design;

FIG. 2 is a rear perspective view thereof;

FIG. 3 is a front elevational view thereof;

FIG. 4 is a rear elevational view thereof;

FIG. 5 is a left side elevational view thereof;

FIG. 6 is a right side elevational view thereof;

FIG. 7 is a top plan view thereof;

FIG. 8 is a bottom plan view thereof; and,

FIG. 9 is a front exploded perspective view thereof, showing how the transparent cover and the three flexible inserts assemble together wherein the three flexible inserts are respectively received in three recesses formed on an inner side of a side wall of the transparent cover.

The broken line showing of environment is for illustrative purposes only and forms no part of the claimed design.

1 Claim, 9 Drawing Sheets

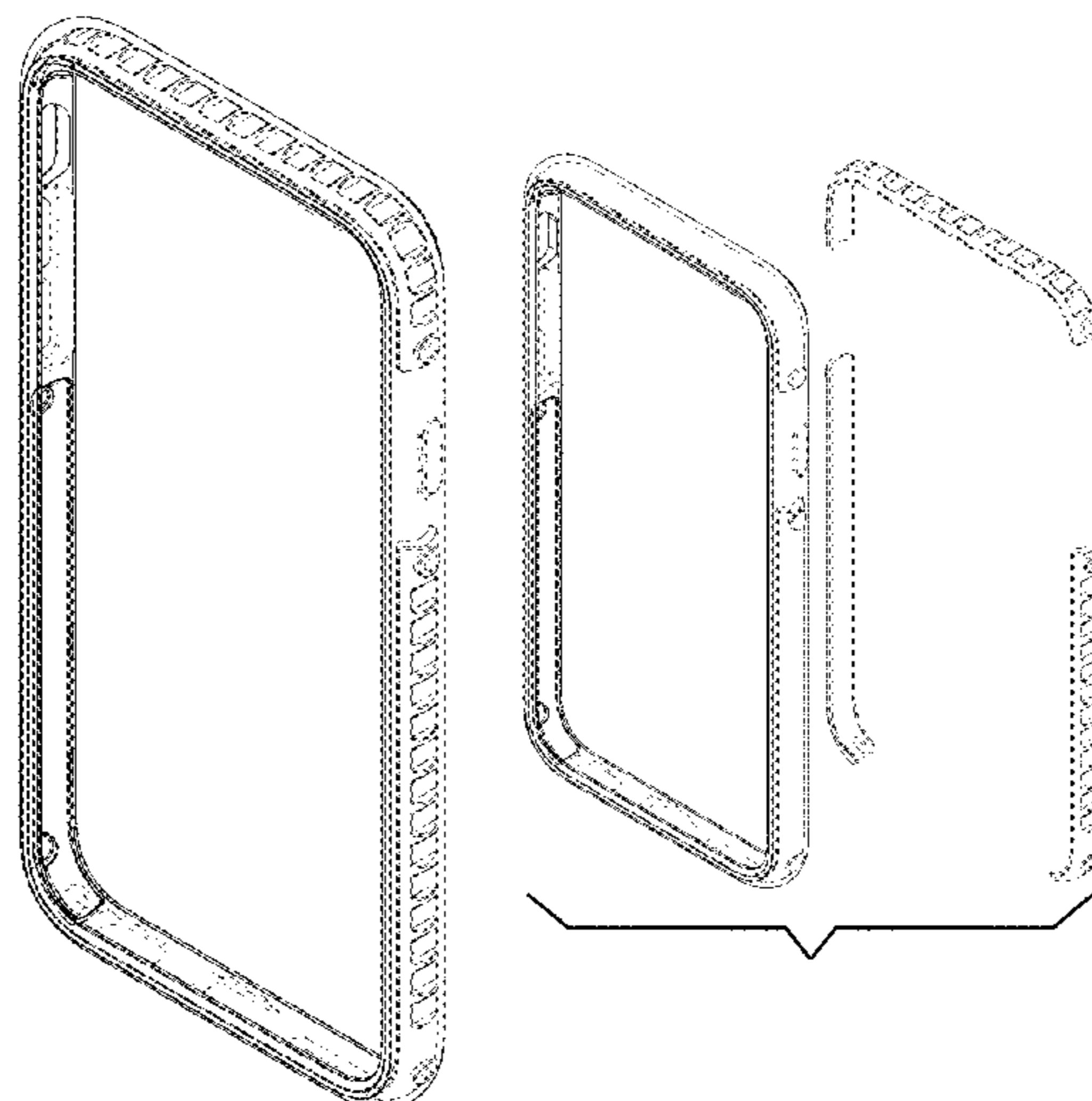

(56)

References Cited

U.S. PATENT DOCUMENTS

D748,612 S *	2/2016	Chan	D14/250
9,247,795 B2 *	2/2016	Kim	A45C 11/00
D753,641 S	4/2016	Roberts et al.	
D754,651 S	4/2016	Roberts et al.	
D754,652 S	4/2016	Roberts et al.	
D756,344 S	5/2016	Roberts et al.	
D756,345 S	5/2016	Roberts et al.	
D757,704 S	5/2016	Roberts et al.	
D758,986 S *	6/2016	Yang	D14/138 G
D761,239 S *	7/2016	Kim	D14/250
D763,841 S *	8/2016	Kim	D14/250
D775,615 S *	1/2017	Tien	D14/250
D780,738 S *	3/2017	Barfoot	D14/250
D785,612 S *	5/2017	Kim	D14/248

OTHER PUBLICATIONS

Spigen UK, Ultra Hybrid Tech Case for Iphone 6s, “<https://www.youtube.com/watch?v=AM-9ufD2Vp4>”; first available online Sep. 21, 2015 (retrieved Jun. 10, 2017).*

“Evo Band Case Apple Iphone 6 Plus/ 6s Plus”, https://www.tech21.com/en_us/evobandcaseforappleiphone6plus6splus, Downloaded Aug. 18, 2016.

“Evo Elite Case Apple Iphone 6 Plus/ 6s Plus”, https://www.tech21.com/en_us/evoelitecaseforappleiphone6plus6splus, Downloaded Aug. 18, 2016.

“Evo Mesh Case Apple Iphone 6 Plus/ 6s Plus”, https://www.tech21.com/en_us/evomeshcaseforappleiphone6plus6splus, Downloaded Aug. 18, 2016.

“Evo Mesh Sport Case Apple Iphone 6 Plus/ 6s Plus”, https://www.tech21.com/en_us/evomeshsportcaseforappleiphone6plus6splus, Downloaded Aug. 18, 2016.

“Evo Tactical Case Apple Iphone 6 Plus/ 6s Plus”, https://www.tech21.com/en_us/evotacticalcaseforappleiphone6plus6splus, Downloaded Aug. 18, 2016.

“Evo Tactical XT Case Apple Iphone 6 Plus/ 6s Plus”, https://www.tech21.com/en_us/evotacticalxtcaseforappleiphone6plus6splus, Downloaded Aug. 18, 2016.

“Evo Wallet Case Apple Iphone 6 Plus/ 6s Plus”, https://www.tech21.com/en_us/evowalletcaseforappleiphone6plus6splus, Downloaded Aug. 18, 2016.

“Impact Clear Case Apple Iphone 6 Plus/ 6s Plus”, https://www.tech21.com/en_us/impactclearcaseforappleiphone6plus6splus, Downloaded Aug. 18, 2016.

“Patriot Case Apple Iphone 6 Plus/ 6s Plus”, https://www.tech21.com/en_us/patriotcaseforappleiphone6plus6splus, Downloaded Aug. 18, 2016.

“Evo Band Case Apple Iphone 6/ 6s”, https://www.tech21.com/en_us/evobandcaseforappleiphone66s, Downloaded Aug. 18, 2016.

“Evo Check Case Apple Iphone 6/ 6s”, https://www.tech21.com/en_us/evocheckcaseforappleiphone66s, Downloaded Aug. 18, 2016.

“Evo Elite Case Apple Iphone 6/6s”, https://www.tech21.com/en_us/evoelitecaseforappleiphone66s, Downloaded Aug. 18, 2016.

“Evo Endurance Charging Case Apple Iphone 6/6s”, https://www.tech21.com/en_us/evoendurancechargingcaseforappleiphone66s, Downloaded Aug. 18, 2016.

“Evo Mesh Case Apple Iphone 6/ 6s”, https://www.tech21.com/en_us/evomeshcaseforappleiphone66s, Downloaded Aug. 18, 2016.

“Evo Mesh Sport Case Apple Iphone 6/ 6s”, https://www.tech21.com/en_us/evomeshsportcaseforappleiphone66s, Downloaded Aug. 18, 2016.

“Evo Tactical Case Apple Iphone 6/ 6s”, https://www.tech21.com/en_us/evotacticalcaseforappleiphone66s, Downloaded Aug. 18, 2016.

“Evo Tactical XT Case Apple Iphone 6/ 6s”, https://www.tech21.com/en_us/evotacticalxtcaseforappleiphone66s, Downloaded Aug. 18, 2016.

“Evo Wallet Case Apple Iphone 6/ 6s”, https://www.tech21.com/en_us/evowalletcaseforappleiphone66s, Downloaded Aug. 18, 2016.

“Evo Xplorer Case Apple Iphone 6/ 6s”, https://www.tech21.com/en_us/evoxplorercaseforappleiphone66s, Downloaded Aug. 18, 2016.

“Impact Clear Case Apple Iphone 6/ 6s”, https://www.tech21.com/en_us/impactclearcaseforappleiphone66s, Downloaded Aug. 18, 2016.

“Patriot Case Apple Iphone 6/ 6s”, https://www.tech21.com/en_us/patriotcaseforappleiphone66s, Downloaded Aug. 18, 2016.

“Evo Mesh Case Apple Iphone 5/ 5s/ SE”, https://www.tech21.com/en_us/evomeshcaseforappleiphone55sse, Downloaded Aug. 18, 2016.

“Evo Tactical Case Apple Iphone 5/ 5s/ SE”, https://www.tech21.com/en_us/evotacticalcaseforappleiphone55sse, Downloaded Aug. 18, 2016.

“Impact Clear Case Apple Iphone SE”, https://www.tech21.com/en_us/impactclearcaseforappleiphonese, Downloaded Aug. 18, 2016.

“Patriot Case Apple Iphone 5/ 5s/ SE”, https://www.tech21.com/en_us/patriotcaseforappleiphone55sse, Downloaded Aug. 18, 2016.

* cited by examiner

FIG. 1

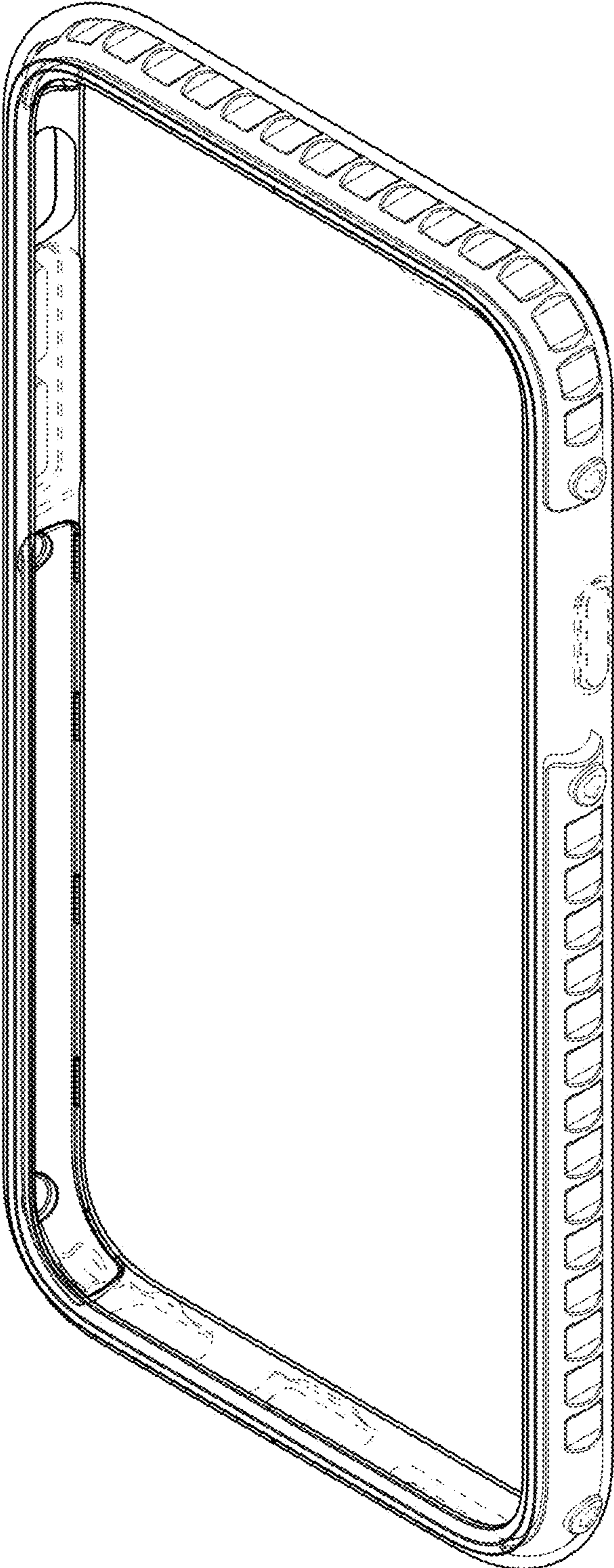

FIG. 2

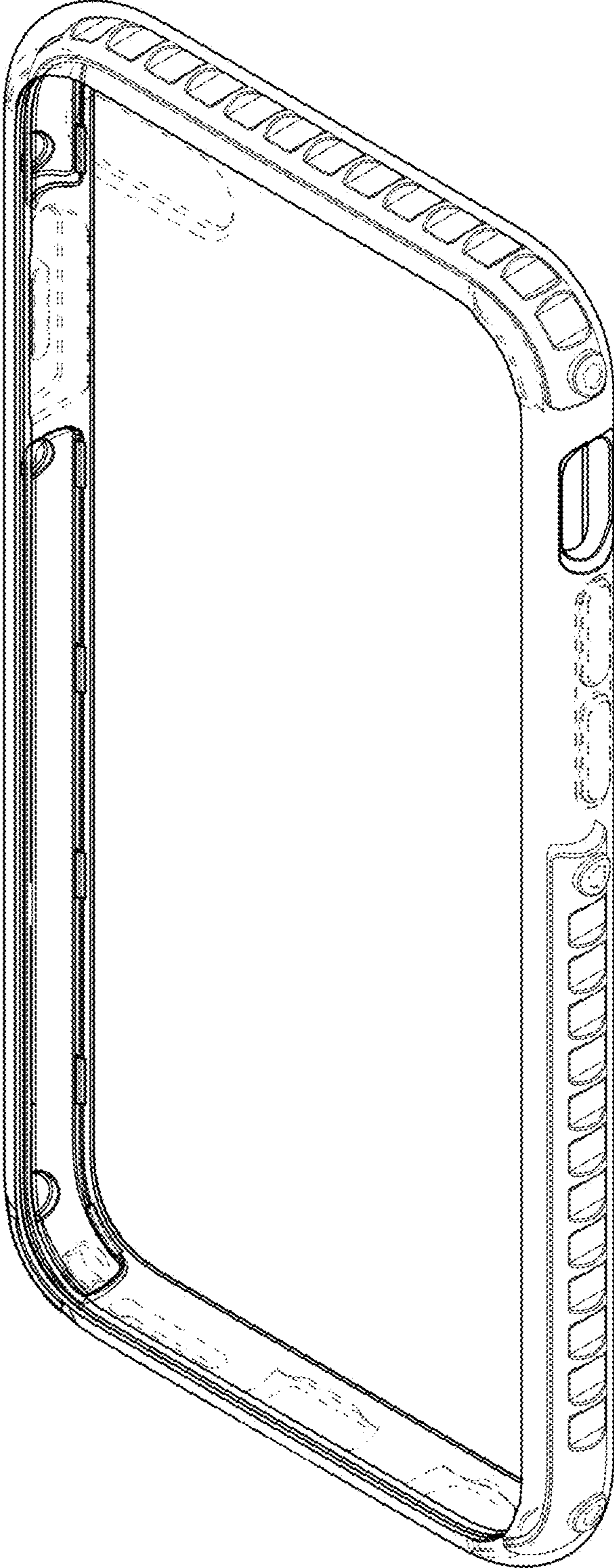

FIG. 3

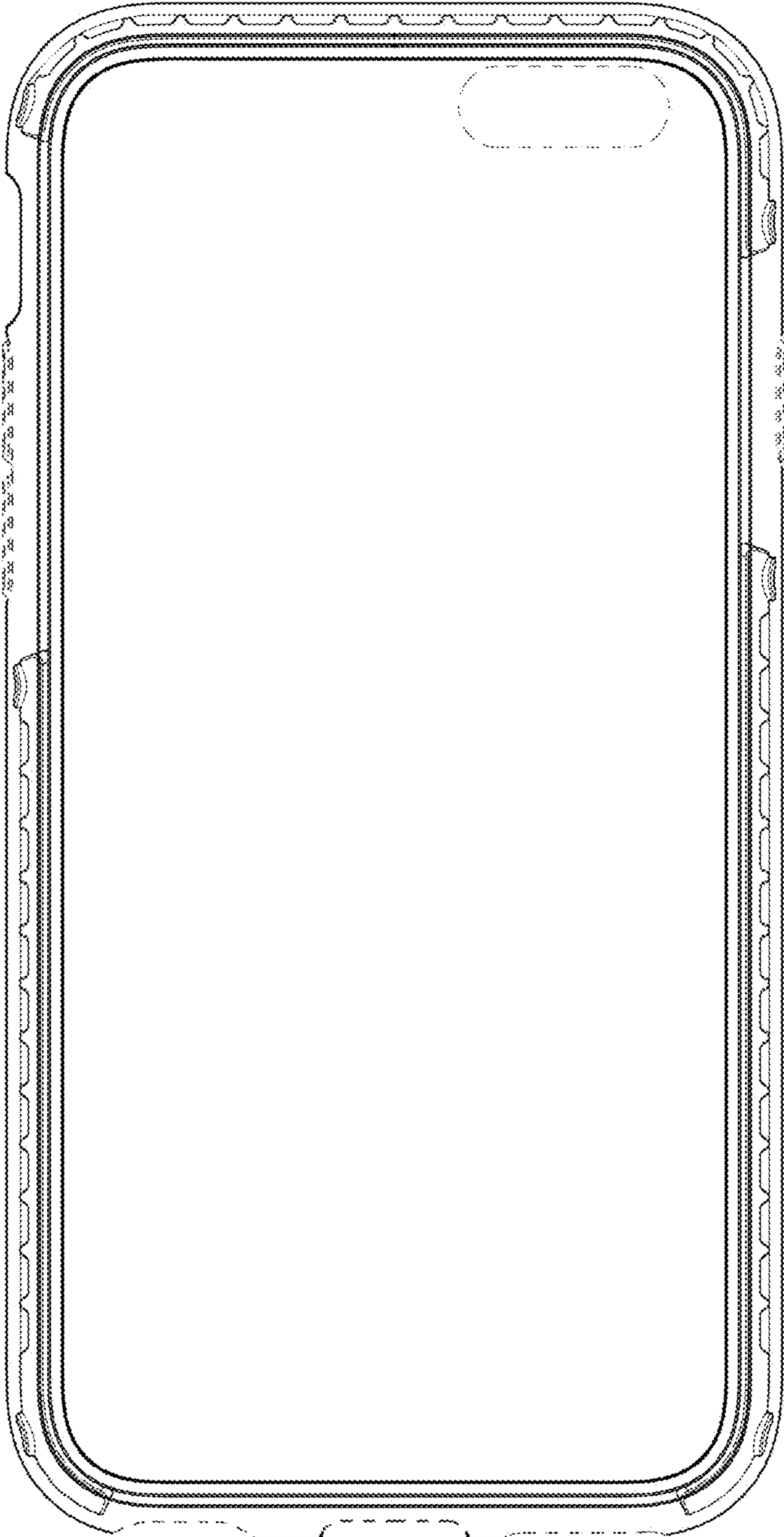

FIG. 4

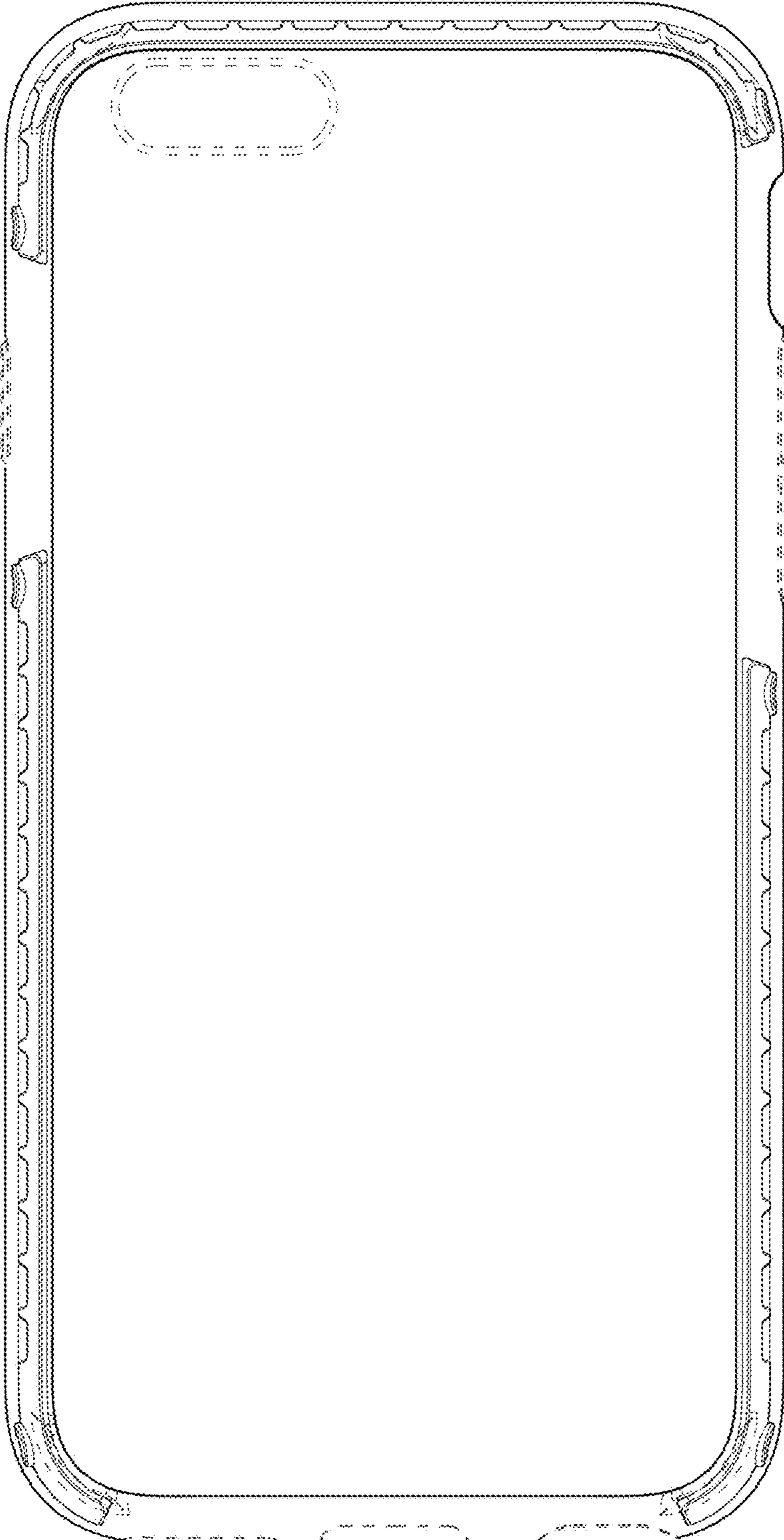

FIG. 5

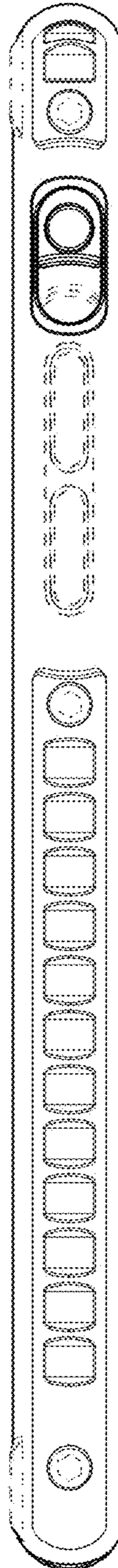

FIG. 6

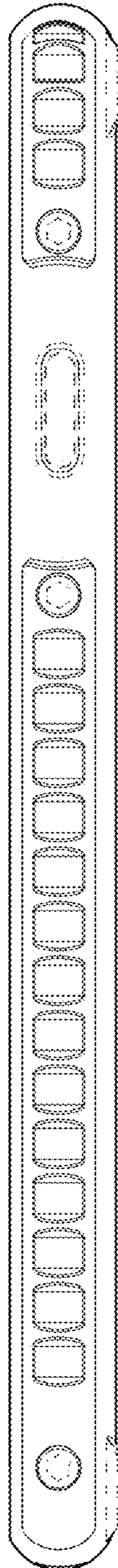

FIG. 7

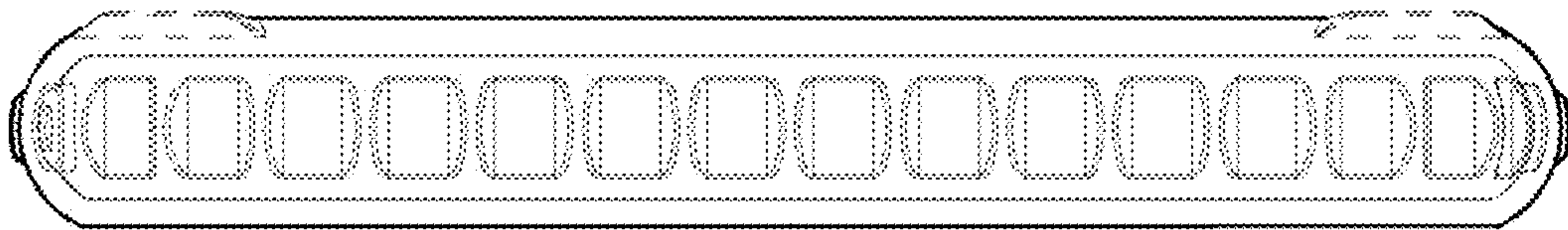

FIG. 8

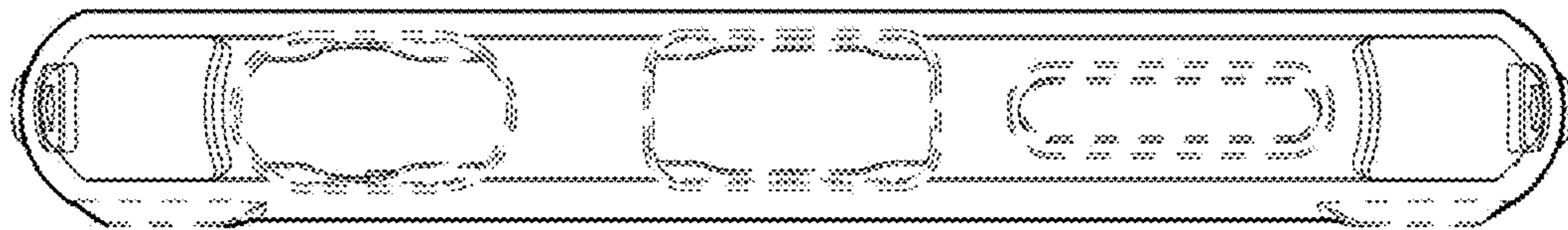

FIG. 9

