



US00D809485S

(12) **United States Design Patent**
McManigal et al.

(10) **Patent No.:** **US D809,485 S**

(45) **Date of Patent:** **** Feb. 6, 2018**

(54) **REMOTE CONTROL**

(71) Applicant: **Vizio Inc**, Irvine, CA (US)

(72) Inventors: **Scott McManigal**, Irvine, CA (US);
Glen Kim, Irvine, CA (US)

(73) Assignee: **Vizio Inc**, Irvine, CA (US)

(**) Term: **15 Years**

(21) Appl. No.: **29/587,661**

(22) Filed: **Dec. 14, 2016**

(51) **LOC (11) Cl.** **14-03**

(52) **U.S. Cl.**
USPC **D14/218**

(58) **Field of Classification Search**
USPC D13/168; D14/218
CPC H03J 1/0025; H01H 9/0235; H04B 1/202;
G08C 17/00; G08C 17/02; G08C 19/00;
G08C 19/12; G08C 19/28; G08C 23/02;
G08C 23/04; H04N 21/42204; H04N
21/4221; H04N 21/4222

See application file for complete search history.

(56) **References Cited**

U.S. PATENT DOCUMENTS

D621,371 S * 8/2010 Sheppard D13/168
D639,278 S * 6/2011 Chai D14/218
D650,365 S * 12/2011 McManigal D14/218

D652,820 S * 1/2012 Peh D14/218
D673,934 S * 1/2013 Shin D14/218
D697,055 S * 1/2014 McManigal D14/218
D730,874 S * 6/2015 McManigal D14/218
D742,857 S * 11/2015 Andresen D14/218
D760,699 S * 7/2016 Peh D14/218
D777,144 S * 1/2017 McManigal D14/218
D795,842 S * 8/2017 Cha D14/218
2015/0123773 A1 * 5/2015 Markwell G08C 17/02
340/12.22
2016/0100118 A1 * 4/2016 Smith H04N 21/42224
348/734

* cited by examiner

Primary Examiner — Selina Sikder

(74) *Attorney, Agent, or Firm* — Law Office of Scott C Harris Inc

(57) **CLAIM**

We claim the ornamental design for a remote control, as shown and described.

DESCRIPTION

FIG. 1 shows a first perspective view of the remote control; FIG. 2 shows a front view of the remote control; FIG. 3 shows a rear view of the remote control; FIG. 4 shows a first side view of the remote control; FIG. 5 shows a second side view of the remote control; FIG. 6 shows a top side view of the remote control; and, FIG. 7 shows a bottom side view of the remote control. The portions shown in broken lines form no part of the claimed design.

1 Claim, 5 Drawing Sheets

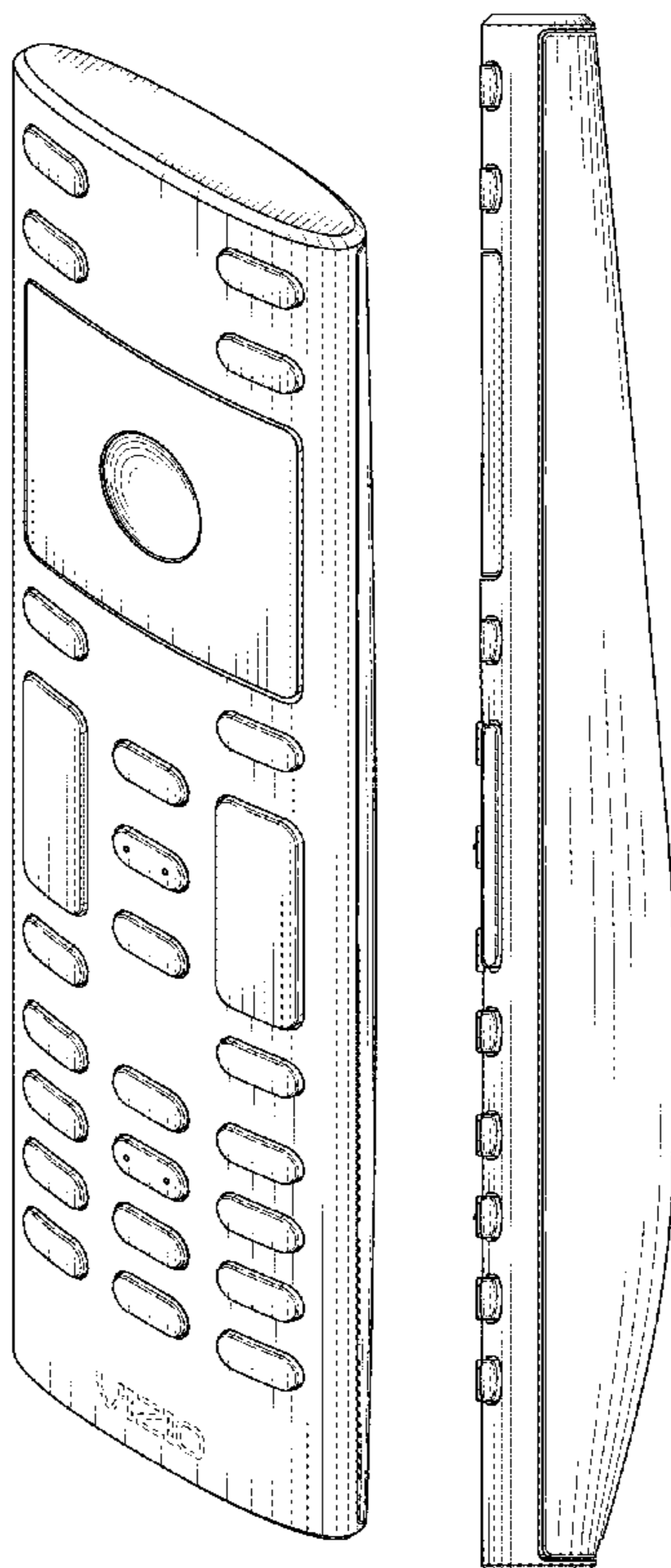

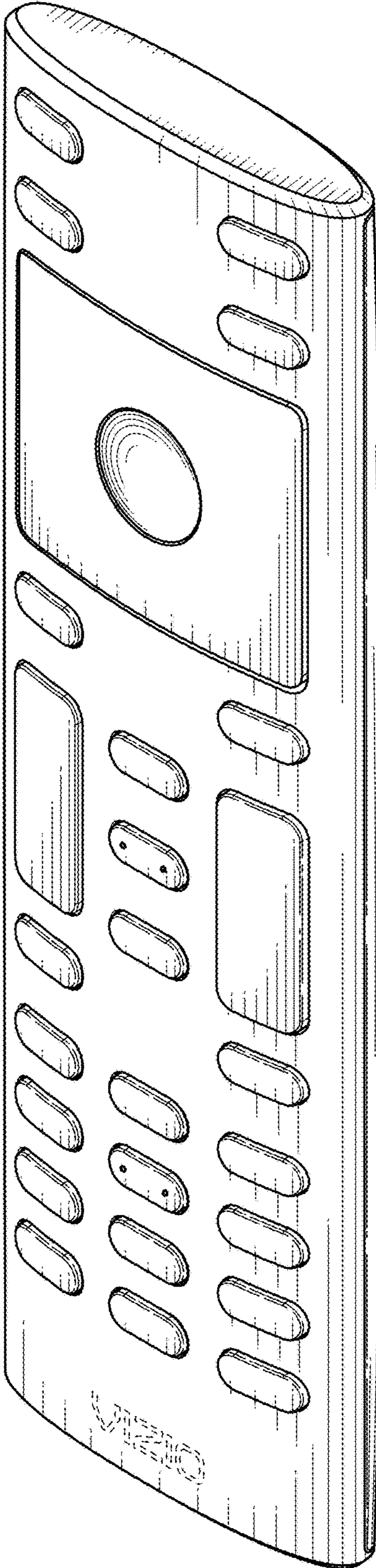

FIG. 1

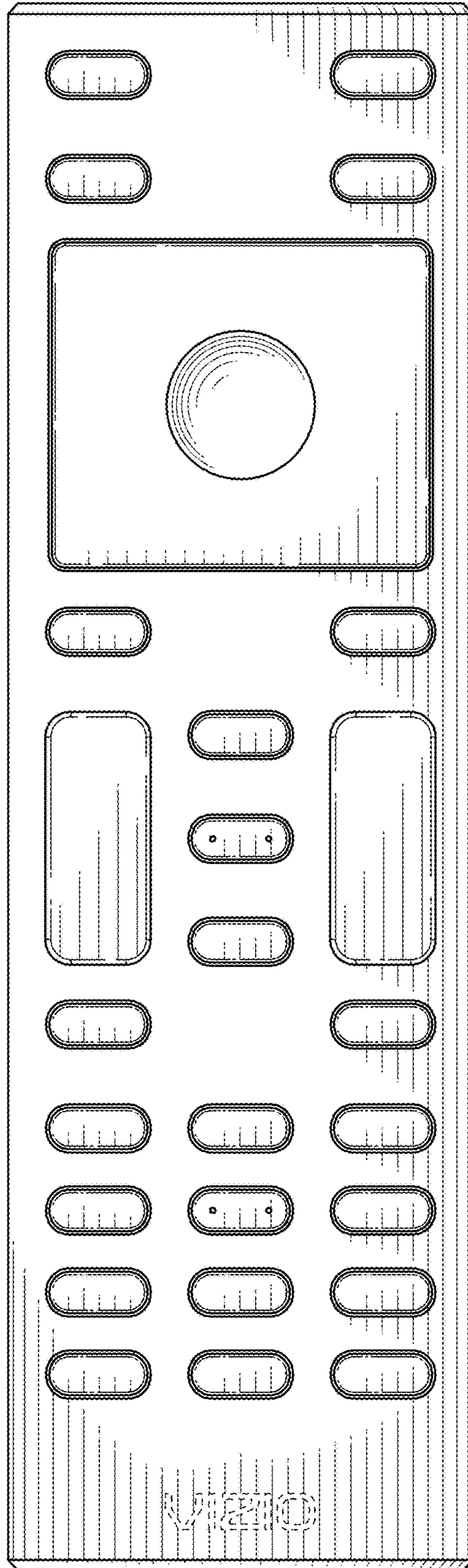

FIG. 2

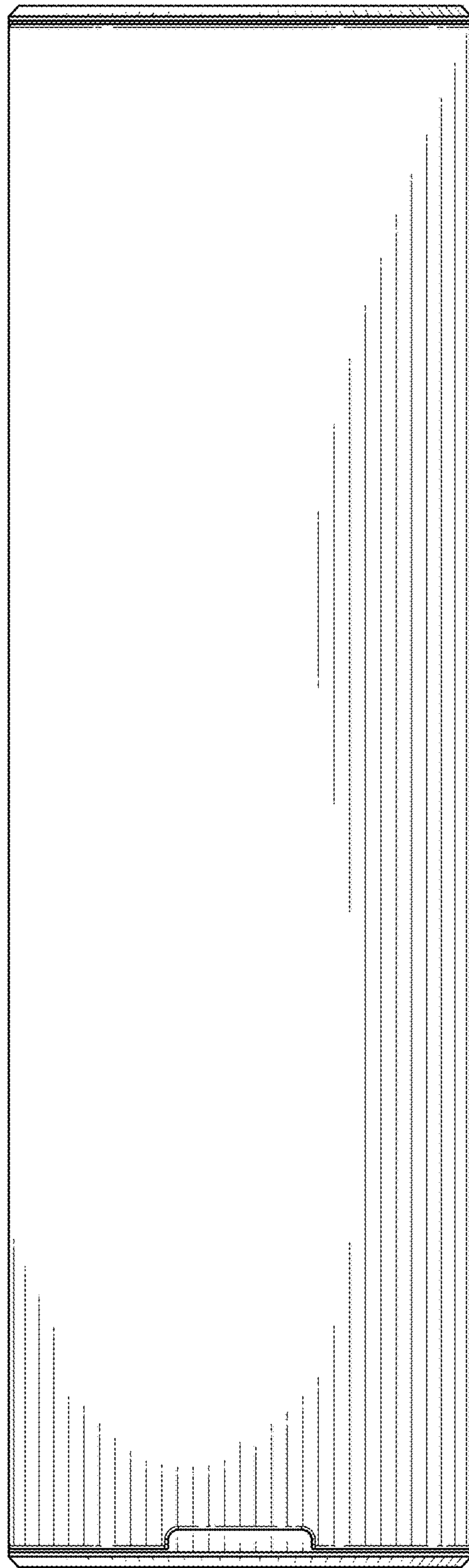

FIG. 3

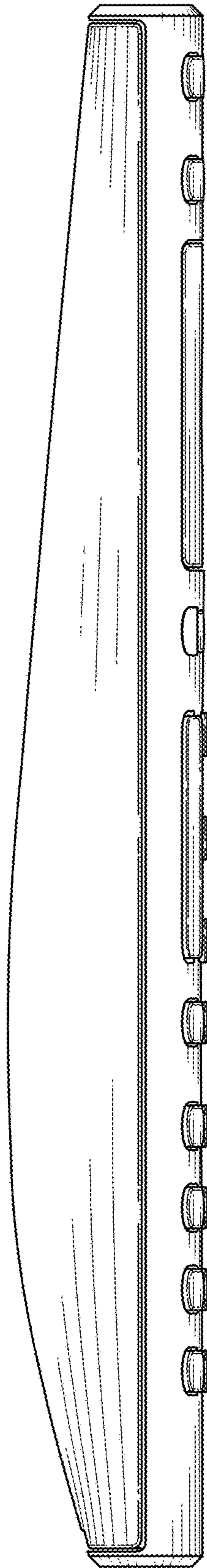

FIG. 4

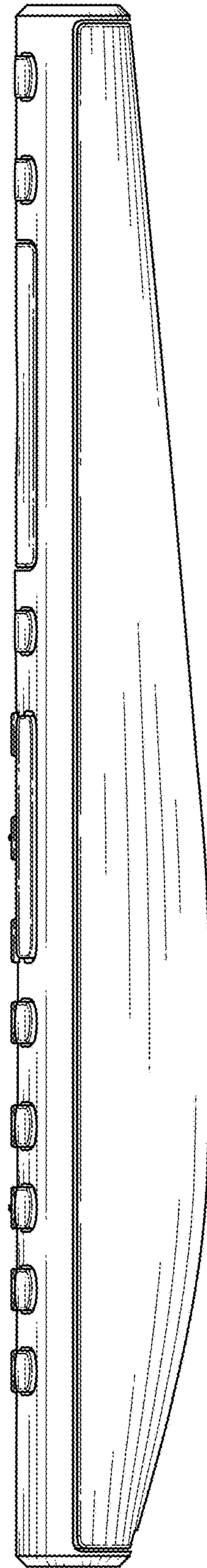

FIG. 5

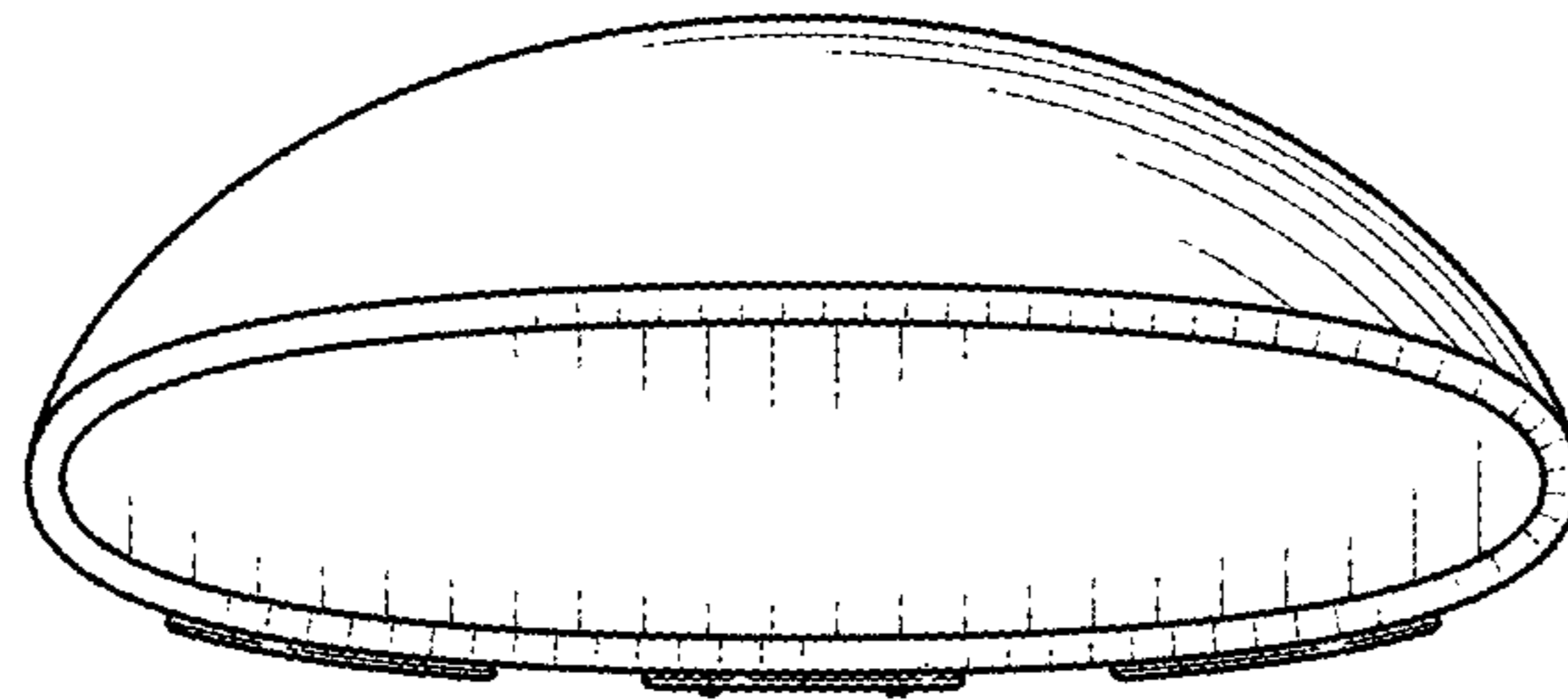

FIG. 6

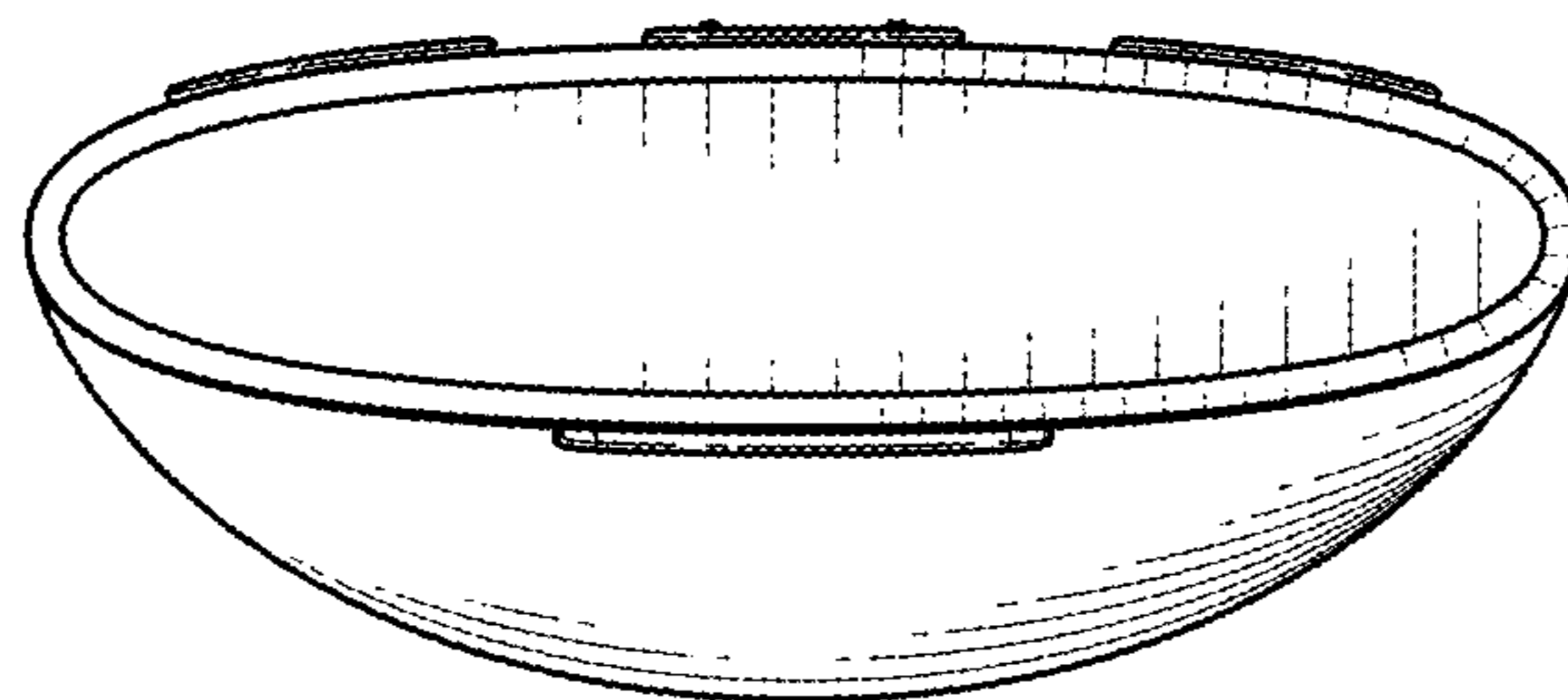

FIG. 7